

# ***UNIVERGE<sup>®</sup> SV9100***

---

## **Features and Specifications Manual**



NEC Corporation of America reserves the right to change the specifications, functions, or features at any time without notice.

NEC Corporation of America has prepared this document for use by its employees and customers. The information contained herein is the property of NEC Corporation of America and shall not be reproduced without prior written approval of NEC Corporation of America.

*D<sup>term</sup>*, NEAX and UNIVERGE are registered trademarks of NEC Corporation and Electra Elite is a registered trademark of NEC America, Inc. Windows, Outlook and Internet Explorer are registered trademarks of Microsoft Corporation. AT&T, the AT&T logo and all other AT&T marks are trademarks of AT&T Intellectual Property and/or AT&T affiliated companies. Lucent Technologies is a trademark or service mark of Lucent Technologies Inc. Nortel Networks and the Nortel Networks logo are trademarks of Nortel Networks. Verizon Wireless is a trademark of Verizon Trademark Services, LLC. Pentium is a trademark or registered trademark of Intel Corporation or its subsidiaries in the United States and other countries. ViewCall and ViewMail are registered trademarks of Active Voice, LLC. Adobe, Flash and Reader are registered trademarks of Adobe Systems, Incorporated in the United States and/or other countries. Google is a trademark of Google Inc. Google Play and Google Chrome are trademarks for Google Inc. Mozilla and Firefox are registered trademarks of the Mozilla Foundation. SonicView is a trademark of TriVium Systems, Inc. iPhone is a registered trademark of Apple Inc. App Store<sup>SM</sup> is a service mark of Apple Inc. Safari is a trademark of Apple Inc., registered in the U.S. and other countries. Salesforce.com is a registered trademark of Salesforce.com, inc. Tigerpaw is a registered trademark of Tigerpaw Software, Inc. Plantronics and Savi are registered trademarks of Plantronics, Inc. AMD Athlon and AMD Duron are trademarks of Advanced Micro Devices, Inc. Wi-Fi is a registered trademark of Wi-Fi Alliance.

**Copyright 2016**

**NEC Corporation of America  
3929 W. John Carpenter Freeway  
Irving, TX 75063-9406**

Communications Technology Group





# PREFACE

## ***Before Reading this Manual***

This manual provides detailed information for each of the system's features. If you are not familiar with the features, the Table of Contents provides a list of the features and where to find the feature within the manual.

## **GENERAL INFORMATION**

### **Congratulations! You have purchased the NEC UNIVERGE SV9100 System.**

The UNIVERGE SV9100 system is a feature-rich key system that provides many features including NEC Contact Center, IP Station and IP Trunk support, ISDN compatibility, PBX compatibility, TAPI compatibility, Voice over Internet Protocol and Uniform Call Distribution.

The UNIVERGE SV9100 system meets the customer needs today, and as business expands, the system can be expanded to grow as well.

The UNIVERGE SV9100 system has a set of manuals that provide all the information necessary to install and support the system. This preface describes these manuals.

## **SUPPORTING DOCUMENTS**

### **UNIVERGE SV9100 General Description Manual**

This Manual provides general information about the system, its features, system configuration and standards. This manual provides an overview of the UNIVERGE SV9100 system and can be used to present information to potential customers.

### **SV9100 System Hardware Manual**

The System Hardware Manual is provided for the system installer. This manual has detailed instructions for installing the SV9100 chassis, blades, multiline terminals, and optional equipment.

### **UNIVERGE SV9100 Programming Manual**

This manual provides instructions for programming the UNIVERGE SV9100 system using a multiline terminal or PC.



# TABLE OF CONTENTS

## ***Chapter 1 Introduction***

<b>Section 1</b>	<b>General Information .....</b>	<b>1-1</b>
<b>Section 2</b>	<b>Multiline Terminals used with the System .....</b>	<b>1-1</b>

## ***Chapter 2 Features***

<b>Section 1</b>	<b>About This Chapter .....</b>	<b>2-1</b>
<b>Section 2</b>	<b>Important Notes .....</b>	<b>2-1</b>
<b>Section 3</b>	<b>SV8100 to UNIVERGE SV9100 Feature Comparison List .....</b>	<b>2-2</b>
<b>Section 4</b>	<b>Features .....</b>	<b>2-10</b>
	<i>Account Code Entry .....</i>	<i>2-11</i>
	<i>Account Code - Forced/Verified/Unverified .....</i>	<i>2-16</i>
	<i>Alarm .....</i>	<i>2-23</i>
	<i>Alarm Reports .....</i>	<i>2-26</i>
	<i>Alphanumeric Display .....</i>	<i>2-38</i>
	<i>Analog Communications Interface (ACI) .....</i>	<i>2-40</i>
	<i>Ancillary Device Connection .....</i>	<i>2-47</i>
	<i>Answer Hold .....</i>	<i>2-51</i>
	<i>Answer Key .....</i>	<i>2-54</i>
	<i>Attendant Call Queuing .....</i>	<i>2-57</i>
	<i>Automatic Release .....</i>	<i>2-59</i>
	<i>Automatic Route Selection (ARS) .....</i>	<i>2-63</i>
	<i>    Recognize Extension Location when Logging in with NetLink .....</i>	<i>2-68</i>
	<i>Background Music .....</i>	<i>2-89</i>

<i>Barge-In</i> .....	2-91
<i>Battery Backup - System Memory</i> .....	2-96
<i>Battery Backup - System Power</i> .....	2-98
<i>Callback</i> .....	2-101
<i>Caller ID Call Return</i> .....	2-105
<i>Caller ID</i> .....	2-109
<i>Caller ID – Flexible Calling Party Number</i> .....	2-124
<i>Caller ID – Flexible Ringing</i> .....	2-129
<i>Caller ID – Memo Display Function</i> .....	2-136
<i>Call Appearance (CAP) Keys</i> .....	2-140
<i>Call Arrival (CAR) Keys</i> .....	2-145
<i>Call Duration Timer</i> .....	2-151
<i>Call Forwarding</i> .....	2-153
<i>Call Forwarding with Follow Me</i> .....	2-167
<i>Call Forwarding – Centrex</i> .....	2-170
<i>Call Forwarding, Off-Premise</i> .....	2-175
<i>Call Forwarding/Do Not Disturb Override</i> .....	2-190
<i>Call Monitoring</i> .....	2-192
<i>Call Redirect</i> .....	2-198
<i>Call Waiting/Camp-On</i> .....	2-201
<i>Central Office Calls, Answering</i> .....	2-206
<i>Central Office Calls, Answering – Auto Attendant Enhancement ...</i>	2-217
<i>Central Office Calls, Answering – Playing MOH During VRS/DISA Transfer</i> .....	2-224
<i>Central Office Calls, Placing</i> .....	2-230
<i>Class of Service</i> .....	2-239
<i>Clock/Calendar Display</i> .....	2-260
<i>Code Restriction</i> .....	2-264
<i>Code Restriction Override</i> .....	2-272

*Code Restriction, Dial Block* ..... 2-279

*Conference* ..... 2-283

*Conference – Remote* ..... 2-291

*Conference – Remote Conference Recording* ..... 2-296

*Conference, Voice Call/Privacy Release* ..... 2-300

*Contact Center* ..... 2-303

*Continued Dialing* ..... 2-336

*Cordless DECT Terminals* ..... 2-339

*Cordless Telephone Connection* ..... 2-358

*CO Message Waiting Indication* ..... 2-374

*Data Line Security* ..... 2-379

*Delayed Ringing* ..... 2-382

*Department Calling* ..... 2-386

*Department Step Calling* ..... 2-397

*Dialing Number Preview* ..... 2-400

*Dial Pad Confirmation Tone* ..... 2-402

*Dial Tone Detection* ..... 2-404

*Digital Trunk Clocking* ..... 2-407

*Directed Call Pickup* ..... 2-412

*Directory Dialing* ..... 2-415

*Direct Inward Dialing (DID)* ..... 2-418

*Direct Inward Line (DIL)* ..... 2-438

*Direct Inward System Access (DISA)* ..... 2-443

*Direct Station Selection (DSS) Console* ..... 2-460

*Distinctive Ringing, Tones and Flash Patterns* ..... 2-469

*Door Box* ..... 2-479

*Do Not Disturb* ..... 2-485

*Drop Key* ..... 2-490

*Ecology* ..... 2-495

<i>E-911 Compatibility</i> .....	2-504
<i>Facsimile CO Branch Connection</i> .....	2-539
<i>Flash</i> .....	2-542
<i>Flexible System Numbering</i> .....	2-545
<i>Flexible Timeouts</i> .....	2-568
<i>Forced Trunk Disconnect</i> .....	2-577
<i>General Purpose Relay</i> .....	2-581
<i>Group Call Pickup</i> .....	2-586
<i>Group Listen</i> .....	2-590
<i>Handset Mute</i> .....	2-593
<i>Handsfree and Monitor</i> .....	2-600
<i>Handsfree Answerback/Forced Intercom Ringing</i> .....	2-603
<i>Headset Operation</i> .....	2-606
<i>Hold</i> .....	2-610
<i>Hotel/Motel</i> .....	2-617
<i>Hotline</i> .....	2-636
<i>Hot Key-Pad</i> .....	2-642
<i>Howler Tone Service</i> .....	2-645
<i>InControl Call Reporting</i> .....	2-647
<i>InMail</i> .....	2-652
<i>InMail – Automatic Access to VM by Caller ID</i> .....	2-695
<i>InMail – Cascade Message Notification</i> .....	2-701
<i>InMail – Email Notification</i> .....	2-723
<i>InMail – Find-Me Follow-Me</i> .....	2-732
<i>InMail – Language Setting</i> .....	2-740
<i>InMail – Park and Page</i> .....	2-745
<i>InMail – Upload Download Audio</i> .....	2-752
<i>Instant Access Application (IAA)</i> .....	2-760
<i>Intercom</i> .....	2-764

<i>InVPN Server</i> .....	2-771
<i>IP Multiline Station (SIP)</i> .....	2-778
<i>NAPT Traversal</i> .....	2-786
<i>IP Multiline Station (SIP) – MLC Mobile</i> .....	2-797
<i>IP Multiline Station (SIP) – ML440 Cordless</i> .....	2-810
<i>IP Multiline Station (SIP) – ML440/G566/G266 with AP400/AP300</i> .....	2-824
<i>IP Multiline Telephone (UT880)</i> .....	2-841
<i>IP Single Line Telephone (SIP)</i> .....	2-854
<i>STD SIP – TCP Connection Support</i> .....	2-864
<i>STD SIP – TLS Connection Support</i> .....	2-866
<i>VoIP and CPU LAN Link – Speed and Duplex Mode</i> .....	2-873
<i>STD SIP Transfer-Unattended</i> .....	2-874
<i>STD SIP Conference</i> .....	2-876
<i>IP Single Line Telephone (SIP) – NAT Mode</i> .....	2-890
<i>IP Trunk – H.323</i> .....	2-896
<i>IP Trunk – Multi Gateway Address Support</i> .....	2-905
<i>IP Trunk – TLS Support on SIP Trunk</i> .....	2-911
<i>IP Trunk – (SIP) Session Initiation Protocol</i> .....	2-919
<i>SIP Trunk E.164 Support</i> .....	2-923
<i>SIP Trunk E.164 CLIP Enhancement</i> .....	2-925
<i>Video Support over SIP Trunks</i> .....	2-927
<i>SIP Trunk – Fax Pass-Through</i> .....	2-963
<i>SIP Trunk Keep Alive using OPTION message</i> .....	2-971
<i>IP Video Doorphone</i> .....	2-974
<i>IP/Digital Call Logging</i> .....	2-981
<i>XML Call Recording Control (IP Terminals Only)</i> .....	2-983
<i>ISDN Compatibility</i> .....	2-987
<i>ISDN 2 B-Channel Transfer</i> .....	2-993
<i>IVR – Appointment Reminder Server</i> .....	2-1010
<i>IVR – Broadcast Server</i> .....	2-1016
<i>K-CCIS – Call Rerouting</i> .....	2-1023

<i>K-CCIS – IP</i> .....	2-1034
<i>CCIS Networking via IP (Peer to Peer Connections Basis)</i> .....	2-1038
<i>K-CCIS – IP with PVA</i> .....	2-1044
<i>K-CCIS – T1</i> .....	2-1052
<i>Last Number Redial</i> .....	2-1059
<i>Licensing</i> .....	2-1063
<i>Temporary License</i> .....	2-1067
<i>Line Load Control</i> .....	2-1075
<i>Line Preference</i> .....	2-1078
<i>Long Conversation Cutoff</i> .....	2-1082
<i>Loop Keys</i> .....	2-1085
<i>Maintenance</i> .....	2-1091
<i>Meet Me Conference</i> .....	2-1093
<i>Meet Me Paging</i> .....	2-1098
<i>Meet Me Paging Transfer</i> .....	2-1103
<i>Memo Dial</i> .....	2-1108
<i>Message Waiting</i> .....	2-1111
<i>Microphone Cutoff</i> .....	2-1118
<i>Migration – SV8100/SV8300</i> .....	2-1121
<i>UX5000 Migration</i> .....	2-1129
<i>Migration – SV9100-S to SV9100-E System</i> .....	2-1131
<i>Mobile Extension</i> .....	2-1133
<i>Callback to Cell Phone</i> .....	2-1140
<i>Mobile Extension – Answer Park Hold</i> .....	2-1154
<i>Multiple Trunk Types</i> .....	2-1162
<i>Multi-Device Support</i> .....	2-1177
<i>Music on Hold</i> .....	2-1192
<i>Name Storing</i> .....	2-1201
<i>NEC Communications Analyst</i> .....	2-1205
<i>NEC E911 Security Notification</i> .....	2-1215



*NEC Meeting Center (NMC) ..... 2-1218*

*Night Service ..... 2-1226*

*Off-Hook Signaling ..... 2-1235*

*One-Touch Calling ..... 2-1240*

*Operator ..... 2-1245*

*(OPX) Off-Premise Extension ..... 2-1247*

*Paging, External ..... 2-1257*

*Paging, External (VRS) ..... 2-1264*

*Paging, Internal ..... 2-1267*

*Park ..... 2-1272*

*Personal Park at a Co-Worker's Extension ..... 2-1274*

*PBX Compatibility ..... 2-1281*

*PC Programming ..... 2-1286*

*Outbound IP Connection ..... 2-1293*

*PC Programming – Security ..... 2-1303*

*PC Programming – WebPro HTTPS Support ..... 2-1306*

*PhonePro ..... 2-1310*

*Power Failure Transfer ..... 2-1315*

*Prime Line Selection ..... 2-1318*

*Private Line ..... 2-1322*

*Programmable Function Keys ..... 2-1327*

*Programming from a Multiline Terminal ..... 2-1332*

*Pulse to Tone Conversion ..... 2-1335*

*Redial Function ..... 2-1337*

*Remote (System) Upgrade ..... 2-1343*

*Repeat Redial ..... 2-1346*

*Resident System Program ..... 2-1349*

*Reverse Voice Over ..... 2-1351*

*RGA Conference ..... 2-1355*

<i>RGA Router</i> .....	2-1362
<i>Ringdown Extension, Internal/External</i> .....	2-1367
<i>Ring Groups</i> .....	2-1371
<i>Room Monitor</i> .....	2-1376
<i>Save Number Dialed</i> .....	2-1383
<i>Secondary Incoming Extension</i> .....	2-1387
<i>Secretary Call Pickup</i> .....	2-1393
<i>Secretary Call (Buzzer)</i> .....	2-1396
<i>Security</i> .....	2-1399
<i>Selectable Display Messaging</i> .....	2-1417
<i>Selectable Ring Tones</i> .....	2-1422
<i>Serial Call</i> .....	2-1426
<i>Simple MCU Video</i> .....	2-1428
<i>Simple Network Management Protocol (SNMP)</i> .....	2-1441
<i>Single Line Telephones, Analog 500/2500 Sets</i> .....	2-1449
<i>Softkeys</i> .....	2-1460
<i>Speed Dial – System/Group/Station</i> .....	2-1463
<i>Speed Dial – Telephone Book</i> .....	2-1480
<i>Station Hunt</i> .....	2-1486
<i>Station Message Detail Recording</i> .....	2-1489
<i>Station Name Assignment – User Programmable</i> .....	2-1512
<i>Station Relocation</i> .....	2-1516
<i>SV9100 InGuard</i> .....	2-1520
<i>SV9100 NetLink</i> .....	2-1523
<i>NetLink Multi-SIP Carrier</i> .....	2-1529
<i>SV9100 PoE Gigabit Switch</i> .....	2-1539
<i>SV9100 Terminals</i> .....	2-1544
<i>Ten Key Backlit Control</i> .....	2-1560
<i>SV9100 UC Suite</i> .....	2-1564

*Synchronous Ringing* ..... 2-1594

*System Caller Log* ..... 2-1597

*T1 Trunking (with ANI/DNIS Compatibility)* ..... 2-1601

*Tandem Ringing* ..... 2-1612

*Tandem Trunking (Unsupervised Conference)* ..... 2-1616

*TAPI Compatibility* ..... 2-1632

*Tone Override* ..... 2-1637

*Traffic Reports* ..... 2-1641

*Transfer* ..... 2-1644

*Trunk Groups* ..... 2-1655

*Trunk Group Routing* ..... 2-1660

*Trunk Queuing/Camp-On* ..... 2-1665

*UM8000 Mail* ..... 2-1669

*uMobility – Wi-Fi Client* ..... 2-1692

*Unicast/Multicast Paging Mode* ..... 2-1704

*Uniform Call Distribution (UCD)* ..... 2-1712

*Uniform Numbering Network* ..... 2-1721

*Universal Slots* ..... 2-1728

*User Programming Ability* ..... 2-1741

*Video Conference with Web RTC* ..... 2-1743

*Virtual Extensions* ..... 2-1759

*Virtual Extensions – Incoming Call History* ..... 2-1768

*Voice Call Recording* ..... 2-1772

*D<sup>term</sup>® Voice Security Recorder (VSR)* ..... 2-1772

*NEC SonicView™ IP Recorder (1.0)* ..... 2-1776

*NEC SonicView Recorder (TDM and IP) (2.0)* ..... 2-1782

*NEC SonicView Recorder (2.7)* ..... 2-1788

*Voice Mail Integration (Analog)* ..... 2-1799

*Voice Mail Message Indication on Line Keys* ..... 2-1821

*Voice Over* ..... 2-1826

*Voice Response System (VRS)* ..... 2-1831

*Voice Response System (VRS) Upload Download Audio* ..... 2-1854

*Voice Response System (VRS) – Call Forwarding – Park and Page* ..... 2-1861

*Volume Controls* ..... 2-1866

*Warning Tone for Long Conversation* ..... 2-1869

*Wireless DECT (SIP)* ..... 2-1873

*Off-Hook Signaling* ..... 2-1883

*Caller ID Display After a Call Transfer* ..... 2-1884

*Out of Range Call Warning Notification* ..... 2-1885

## ***Chapter 3***      ***Codes Tables***

**Section 1**    **About This Chapter** ..... **3-1**

**Section 2**    **Simplifying Multiline Terminal Operations with One-Touch Key Operation** ..... **3-1**

**Section 3**    **Using Handsfree** ..... **3-1**

## ***Chapter 4***      ***Feature Availability by Software Revision***

**Section 1**    **Feature Availability Chart** ..... **4-1**

# LIST OF FIGURES

Figure 1-1	SV9100 Key Assignment Example .....	1-2
Figure 2-1	Left Cursor Key Operation Flow Chart .....	2-110
Figure 2-2	Auto Attendant Enhancement Flowchart 1 .....	2-220
Figure 2-3	Auto Attendant Enhancement Flowchart 2 .....	2-221
Figure 2-4	Auto Attendant Enhancement Flowchart 3 .....	2-222
Figure 2-5	Auto Attendant Enhancement Flowchart 4 .....	2-223
Figure 2-6	VRS/DISA Transfer to Extension .....	2-224
Figure 2-7	Playing MOH During VRS/DISA Transfer – Flow Chart .....	2-225
Figure 2-8	Department Calling Priority Call Routing .....	2-389
Figure 2-9	Department Calling Circular Routing .....	2-390
Figure 2-10	Digital Trunk Clocking Example 1 .....	2-408
Figure 2-11	Digital Trunk Clocking Example 2 .....	2-409
Figure 2-12	Digital Trunk Clocking Example 3 .....	2-409
Figure 2-13	Digital Trunk Clocking Example 4 .....	2-409
Figure 2-14	Digital Trunk Clocking Example 5 .....	2-410
Figure 2-15	Digital Trunk Clocking Example 6 .....	2-410
Figure 2-16	Digital Trunk Clocking Example 7 .....	2-410
Figure 2-17	Digital Trunk Clocking Example 8 .....	2-411
Figure 2-18	Trunk Distinctive Ringing Flow Chart .....	2-471
Figure 2-19	ICM Distinctive Ringing Flow Chart .....	2-472
Figure 2-20	Automatic Night Service .....	2-501
Figure 2-21	Multiline Terminal Darkens .....	2-503
Figure 2-22	CCIS Standard Calls .....	2-509
Figure 2-23	CCIS VE Standard Calls .....	2-512
Figure 2-24	CCIS 911 Calls .....	2-521

Figure 2-25	CCIS VE 911 Calls .....	2-524
Figure 2-26	Station Name Display via Virtual Loopback .....	2-619
Figure 2-27	Example – User Access to Voice Mail .....	2-695
Figure 2-28	Cascade Message Notification Flow Chart-1 .....	2-703
Figure 2-29	Cascade Message Notification Flow Chart-2 .....	2-704
Figure 2-30	Cascade Message Notification Flow Chart-3 .....	2-705
Figure 2-31	Cascade Message Flow Chart 1 .....	2-721
Figure 2-32	Cascade Message Flow Chart 2 .....	2-722
Figure 2-33	InMail User Pro Login Diagram .....	2-753
Figure 2-34	Example of InVPN Configuration .....	2-771
Figure 2-35	Example – NAT Traversal .....	2-786
Figure 2-36	ML440 Cordless Handset .....	2-810
Figure 2-37	ML440 Cordless Handset .....	2-824
Figure 2-38	G566 and G266 in Desktop Charger .....	2-825
Figure 2-39	UT880 Terminal .....	2-841
Figure 2-40	TLS Configuration .....	2-866
Figure 2-41	SV9100 Authentication .....	2-866
Figure 2-42	TLS Certificate Configuration Screen .....	2-871
Figure 2-43	SSL Certificate Successfully Installed .....	2-871
Figure 2-44	Example of Imported CA Certificates .....	2-872
Figure 2-45	Example – Standard SIP Conference .....	2-876
Figure 2-46	Example – SIP Phone .....	2-888
Figure 2-47	Multi Gateway Address Support .....	2-905
Figure 2-48	Multi Gateway Address .....	2-908
Figure 2-49	UPnP and Multi Gateway Address .....	2-909
Figure 2-50	TLS Support on SIP Trunk .....	2-911
Figure 2-51	SIP Server Authentication .....	2-911
Figure 2-52	Certificate Registration .....	2-917
Figure 2-53	Upload Certificate File .....	2-917

Figure 2-54	Certificate File Error .....	2-918
Figure 2-55	Delete Certificate File .....	2-918
Figure 2-56	SIP Profile Support on SV9100 .....	2-920
Figure 2-57	Start Recording .....	2-984
Figure 2-58	Recording .....	2-984
Figure 2-59	Paused .....	2-984
Figure 2-60	Information Screen .....	2-985
Figure 2-61	Comment List Screen .....	2-985
Figure 2-62	K-CCIS Call Rerouting Network .....	2-1023
Figure 2-63	Left Cursor Key Operation Flow Chart .....	2-1059
Figure 2-64	Mobile Extension Layout .....	2-1133
Figure 2-65	Example – Callback to Cell Phone .....	2-1140
Figure 2-66	Multi-Device Group Extension Example .....	2-1177
Figure 2-67	E911 Deployment Example .....	2-1215
Figure 2-68	PC Programming Overview .....	2-1286
Figure 2-69	PCPro Connection Dialog .....	2-1287
Figure 2-70	WebPro Login Screen .....	2-1288
Figure 2-71	WebPro Home Page .....	2-1288
Figure 2-72	Maintenance Debug Screen .....	2-1289
Figure 2-73	WebPro End User Screen .....	2-1289
Figure 2-74	Example of HTTPS Encryption .....	2-1306
Figure 2-75	Left Cursor Key Operation Flow Chart .....	2-1337
Figure 2-76	Idle Terminal Display .....	2-1402
Figure 2-77	Confirm Ring Time Display .....	2-1403
Figure 2-78	No Answer Display .....	2-1405
Figure 2-79	Maximum of Four Standard SIP Phone Users .....	2-1428
Figure 2-80	SNMP – Hardware Key Code Request .....	2-1447
Figure 2-81	SNMP – CPU IP Address Request .....	2-1447
Figure 2-82	SNMP – Set Trap Alarm 64 .....	2-1448

Figure 2-83	SNMP – Trap Alarm Details .....	2-1448
Figure 2-84	Right Cursor Key Operation Flow Chart .....	2-1464
Figure 2-85	Example of SMDR Report .....	2-1492
Figure 2-86	Virtual Loopback – S-Point .....	2-1493
Figure 2-87	Example of S-Point Report .....	2-1493
Figure 2-88	Example of S-Point Report (Flagged) .....	2-1493
Figure 2-89	Virtual Loopback – T-Point .....	2-1494
Figure 2-90	Example of Twice Through Virtual Loop .....	2-1494
Figure 2-91	Example of Twice Through Virtual Loop (Reverse Order) .....	2-1494
Figure 2-92	Virtual Loopback – External Call Routed Through T-Point .....	2-1495
Figure 2-93	Example of Twice Through Virtual Loop (Reverse Direction) .....	2-1495
Figure 2-94	Example – NetLink Multiple Carrier .....	2-1529
Figure 2-95	SV9100 Encryption Configuration .....	2-1545
Figure 2-96	System Caller Log Example 1 .....	2-1600
Figure 2-97	System Caller Log Example 2 .....	2-1600
Figure 2-98	VPN Between Smart Device and Office LAN .....	2-1695
Figure 2-99	Port Forwarding without Session Boarder Controller .....	2-1696
Figure 2-100	Port Forwarding with Session Boarder Controller .....	2-1697
Figure 2-101	Multicast Mode Example .....	2-1705
Figure 2-102	Unicast Mode Example .....	2-1705
Figure 2-103	Auto Mode Example .....	2-1706
Figure 2-104	Uniform Call Distribution (UCD) Priority Call Routing .....	2-1714
Figure 2-105	Uniform Call Distribution (UCD) Circular Routing .....	2-1715
Figure 2-106	Audio/Video Conferencing using WebRTC .....	2-1744
Figure 2-107	Login Screen .....	2-1750
Figure 2-108	Video Conference Screen .....	2-1751
Figure 2-109	Conference Screen with Conference ID .....	2-1752
Figure 2-110	Conference Screen with Toolbar .....	2-1753
Figure 2-111	Switch Button for Video/Screen Sharing .....	2-1755



Figure 2-112	NEC Screen Sharing Window .....	2-1756
Figure 2-113	Example of Users Sharing Window .....	2-1756
Figure 2-114	Stop Screen Sharing or Camera Switch Window .....	2-1757
Figure 2-115	Virtual Extension – Incoming Call History .....	2-1768
Figure 2-116	VRS User Pro Login Diagram .....	2-1855
Figure 2-117	IP DECT – 2nd Indication .....	2-1883
Figure 2-118	IP DECT – Caller ID Display .....	2-1884
Figure 2-119	Out of Range Example .....	2-1885



# LIST OF TABLES

Table 2-1	Feature Comparison List .....	2-2
Table 2-2	Sample Alarm Report .....	2-26
Table 2-3	Alarm Report Definitions .....	2-27
Table 2-4	Alarm Report Item Definitions .....	2-28
Table 2-5	Sample System Information Printout .....	2-28
Table 2-6	DT330 Compatibility Settings .....	2-48
Table 2-7	Firmware Compatibility Matrix .....	2-48
Table 2-8	Keys for Entering Names .....	2-120
Table 2-9	Caller ID Matching Rule .....	2-131
Table 2-10	Editing Program 10-04-04 .....	2-226
Table 2-11	Program 10-04-01 Settings .....	2-227
Table 2-12	Dial Tone Detection Program Interaction .....	2-406
Table 2-13	Example 2 (Manual Change) .....	2-422
Table 2-14	Example 1 – Monday ~ Friday .....	2-424
Table 2-15	Example 2 – Saturday .....	2-424
Table 2-16	Example 3 – Sunday .....	2-424
Table 2-17	LED Flash Patterns .....	2-437
Table 2-18	Distinctive Ringing: Tones and Flash Patterns .....	2-469
Table 2-19	Basic Tone Table – Tone 06 .....	2-477
Table 2-20	Basic Tone Table – Tone 14 .....	2-477
Table 2-21	Basic Tone Table – Tone 39 .....	2-477
Table 2-22	Program 12-02: Automatic Night Service Patterns .....	2-500
Table 2-23	CPN for Standard Calls .....	2-505
Table 2-24	CPN for VE Standard Calls .....	2-506
Table 2-25	CPN for 911 Calls .....	2-507

Table 2-26	CPN for VE 911 Calls .....	2-508
Table 2-27	CPN for CCIS Standard Calls .....	2-509
Table 2-28	CPN for CCIS VE Standard Calls .....	2-513
Table 2-29	CPN for CCIS 911 Calls .....	2-521
Table 2-30	CPN for CCIS VE 911 Calls .....	2-525
Table 2-31	CPN for Line Key+911 Calls .....	2-533
Table 2-32	General Purpose Relay Specifications .....	2-581
Table 2-33	Service Tone Setup Defaults, Program 80-01-01 .....	2-594
Table 2-34	Service Tone Setup, Program 80-01-02 .....	2-598
Table 2-35	Valid Room Status Changes when Program 42-01-06 is set to 1 (Enabled) .....	2-623
Table 2-36	Valid Room Status Changes when Program 42-01-06 is set to 0 (Disabled) .....	2-624
Table 2-37	Extension Busy Setup .....	2-641
Table 2-38	SV9100 InMail Part Numbers and Capacities .....	2-655
Table 2-39	InMail Email Account Information .....	2-723
Table 2-40	Typical SMS Notification (No Wav File) .....	2-725
Table 2-41	Common Email Notification SMTP Server Settings .....	2-726
Table 2-42	Some Common Mobile Telephone Service Provider SMS Portals .....	2-726
Table 2-43	Turn Email Notification On or Off .....	2-731
Table 2-44	Language Setting Operation .....	2-744
Table 2-45	Park and Page Call Handling .....	2-746
Table 2-46	Park and Page Call Handling .....	2-747
Table 2-47	Recording Your Paging Message .....	2-750
Table 2-48	Setting the Call Handling Options .....	2-751
Table 2-49	Picking Up a Parked Call .....	2-751
Table 2-50	Default Incoming Ringing Tone .....	2-753
Table 2-51	Error Messages and Causes .....	2-757
Table 2-52	DT700 Series Supported Features (IAA) .....	2-761
Table 2-53	Default Incoming Ringing Tone .....	2-769
Table 2-54	Example – Required System Settings .....	2-787

Table 2-55	Example – Required IP Terminal Settings .....	2-787
Table 2-56	Example – SV9100 System Router A Port Forwarding Settings .....	2-787
Table 2-57	NAPT Terminals – Minimum Timer Settings .....	2-788
Table 2-58	Supported System Feature List .....	2-798
Table 2-59	Handset Features .....	2-827
Table 2-60	Supported System Feature List .....	2-828
Table 2-61	Supported System Feature List .....	2-843
Table 2-62	Minimum Bandwidth Requirements .....	2-854
Table 2-63	Feature Support Table for Standard SIP Device .....	2-857
Table 2-64	Import CA Certificate Requirements .....	2-868
Table 2-65	TLS Certificate Conditions .....	2-868
Table 2-66	SIP Message Encryption .....	2-869
Table 2-67	Example of Terminal Display Alarms .....	2-869
Table 2-68	Example of Conference DSP Resource Requirement .....	2-877
Table 2-69	Example of Terminal Display Alarms .....	2-913
Table 2-70	Authentication Result Error Codes .....	2-914
Table 2-71	SIP INVITE Header Fields .....	2-960
Table 2-72	Delete + from Incoming SIP INVITE .....	2-961
Table 2-73	Delete + and Country Code from Incoming SIP INVITE .....	2-961
Table 2-74	Delete + and Country Code from Incoming SIP INVITE .....	2-962
Table 2-75	DR-Viewer Requirements .....	2-974
Table 2-76	Restrictions for Calling Party Names .....	2-989
Table 2-77	K-CCIS Main and Remote System VoIP Resources Used .....	2-1038
Table 2-78	GCD-PVAA Blade Installed in Slot 6 .....	2-1045
Table 2-79	GCD-PVAA Blade Installed in Slot 4 and Slot 6 .....	2-1046
Table 2-80	Minimum Bandwidth Required .....	2-1047
Table 2-81	License Information .....	2-1069
Table 2-82	SV8100 Supported Hardware .....	2-1121
Table 2-83	SV8100 Supported Terminals .....	2-1123

Table 2-84	SV8100 Conversion Exception .....	2-1123
Table 2-85	Program Data Moved .....	2-1125
Table 2-86	Input Value Change .....	2-1126
Table 2-87	UX5000 Keys .....	2-1129
Table 2-88	Supported Service Codes .....	2-1134
Table 2-89	Supported System Feature List .....	2-1181
Table 2-90	Keys for Entering Names .....	2-1204
Table 2-91	Communications Analyst Support .....	2-1206
Table 2-92	Feature Support Table for Standard SIP Device .....	2-1219
Table 2-93	Feature Support Table for Standard SIP Device .....	2-1220
Table 2-94	Feature Support Table for Standard SIP Device .....	2-1221
Table 2-95	PCPro and WebPro Comparison .....	2-1299
Table 2-96	Selectable Display Messaging Defaults .....	2-1417
Table 2-97	Selectable Display Message – Character Entry Chart .....	2-1420
Table 2-98	Intercom or Trunk Ring Setting .....	2-1424
Table 2-99	Non-MCU Mode Video Channel VoIP Reservation .....	2-1428
Table 2-100	MCU Mode Video Channel VoIP Reservation (Peer-to-Peer Enabled Systems) .....	2-1429
Table 2-101	10. Position .....	2-1442
Table 2-102	30. CPU .....	2-1442
Table 2-103	Feature Licenses .....	2-1443
Table 2-104	Port Licenses .....	2-1443
Table 2-105	Network, Interface, Trapset and Trap .....	2-1444
Table 2-106	IPL Information Using VOIP .....	2-1444
Table 2-107	20. Common .....	2-1444
Table 2-108	Keys for Entering Names .....	2-1476
Table 2-109	SMDR Report Definitions .....	2-1496
Table 2-110	SMDR Report Format with Program 35-02-14 Set to ‘0’ .....	2-1496
Table 2-111	SMDR Report Format with Program 35-02-14 Set to ‘1’ .....	2-1498

Table 2-112	SMDR Summary Report .....	2-1500
Table 2-113	Keys for Entering Names .....	2-1514
Table 2-114	VoIP Resource Chart .....	2-1526
Table 2-115	CPU Reset Programs .....	2-1526
Table 2-116	DT700 Supported Encryption .....	2-1544
Table 2-117	SV9100 Supported Terminals .....	2-1545
Table 2-118	Terminal Category Reference Chart .....	2-1546
Table 2-119	Connectivity of Options (DT300/DT700) .....	2-1549
Table 2-120	Connectivity of Options (DT400/DT800) .....	2-1550
Table 2-121	Terminal and Adapter Compatibility (DT300/DT700) .....	2-1550
Table 2-122	Terminal and Adapter Compatibility (DT400/DT800) .....	2-1551
Table 2-123	DT330 Compatibility Settings .....	2-1552
Table 2-124	Firmware Compatibility Matrix .....	2-1553
Table 2-125	Terminal and Line Key/LCD Compatibility (DT300/DT700) .....	2-1553
Table 2-126	Terminal and Line Key/LCD Compatibility (DT400/DT800) .....	2-1555
Table 2-127	Terminal and Ten Key Kit Compatibility (DT300/DT700) .....	2-1556
Table 2-128	Terminal and Ten Key Kit Compatibility (DT400/DT800) .....	2-1557
Table 2-129	Adapter Compatibility .....	2-1557
Table 2-130	Desktop Suite Licenses .....	2-1573
Table 2-131	Feature Mapping .....	2-1573
Table 2-132	Exceptions to Firewall for Ports .....	2-1574
Table 2-133	Exceptions to Windows Process .....	2-1575
Table 2-134	Station Application .....	2-1598
Table 2-135	Trunk Application .....	2-1598
Table 2-136	TAPI Commands .....	2-1632
Table 2-137	Error Messages and Causes .....	2-1698
Table 2-138	Supported System Feature List .....	2-1699
Table 2-139	SV9100 Maximum System Capacities – Trunks/Ports/Channels .....	2-1729

Table 2-140	SV9100 9.5" (Base and Expansion) Maximum System Capacities – Trunks/Ports/Channels .....	2-1730
Table 2-141	Maximum System Capacities for Station Interface Blades .....	2-1731
Table 2-142	Maximum System Capacities for Trunk Interface Blades .....	2-1734
Table 2-143	Maximum System Capacities for Application Interface Blades .....	2-1736
Table 2-144	Board Power Factor .....	2-1737
Table 2-145	Terminal Power Factor .....	2-1738
Table 2-146	Maximum Number of Packages Installed .....	2-1739
Table 2-147	Recommended Client Device Specifications .....	2-1747
Table 2-148	Hardware Specifications .....	2-1747
Table 2-149	Example of Bandwidth Utilization .....	2-1747
Table 2-150	Common Errors .....	2-1757
Table 2-151	Special Conditions .....	2-1758
Table 2-152	IP Recorder Basic Licenses .....	2-1779
Table 2-153	SV9100 CPU License (NEC SonicView Recorder) .....	2-1786
Table 2-154	Known Limitations .....	2-1788
Table 2-155	System Minimum Requirements .....	2-1793
Table 2-156	Server Hardware Matrix .....	2-1794
Table 2-157	Common Hardware Requirements .....	2-1794
Table 2-158	Supervisor/Agent Studio PC Recommendations .....	2-1795
Table 2-159	Supported Operating Systems .....	2-1796
Table 2-160	Supported Databases .....	2-1796
Table 2-161	SV9100 CPU License (NEC SonicView Recorder) .....	2-1796
Table 2-162	Voice Prompting Messages .....	2-1835
Table 2-163	Default Incoming Ringing Tone .....	2-1855
Table 2-164	Error Messages and Causes .....	2-1859
Table 2-165	Supported Wireless DECT (SIP) Features .....	2-1873
Table 3-1	Post Dialing Service Codes – Single Digit Post Dialing Codes .....	3-2
Table 3-2	Service Codes by Number .....	3-3



Table 3-3      Service Codes by Feature ..... 3-12

Table 3-4      Function Key Codes by Feature ..... 3-21

Table 3-5      Function Key Codes by Number ..... 3-28

Table 4-1      Feature Availability by Software Revision ..... 4-1



## Introduction

# Chapter 1

## SECTION 1 GENERAL INFORMATION

UNIVERGE SV9100 (DTZ/ITY/ITZ terminals) and UNIVERGE SV8100 (DTL / ITL terminals) can be used with the UNIVERGE SV9100 system.

## SECTION 2 MULTILINE TERMINALS USED WITH THE SYSTEM

### SV9100 Terminals

The SV9100 multiline terminals, either with or without LCD display, offer a variety of colors, and line sizes.

- Terminals are available in black or white.
- The large Liquid Crystal Display (LCD) on the display provides call status data and programming information.
- Terminal line sizes include 2, 6, 12, 24, and 32.
- IP Terminals are available in 2, 6, 12, 24, and 32.
- Speakerphone with full handsfree operation and headset jack is standard.
- Only the DT330 series terminals are compatible with APR-L adapters.
- An Attendant Add-On DCL-60-1 Console is available with 60 stations and/or outside line assignments.
- If the page switching key on the DCL-60-1 Console is used, there is a maximum of 120 keys. Two pages of 54 programmable keys and six fixed keys.
- A power failure module PSA-L is available for fail-over to POTS line when there is a loss of power or network connection to the SV9100.

Figure 1-1 SV9100 Key Assignment Example

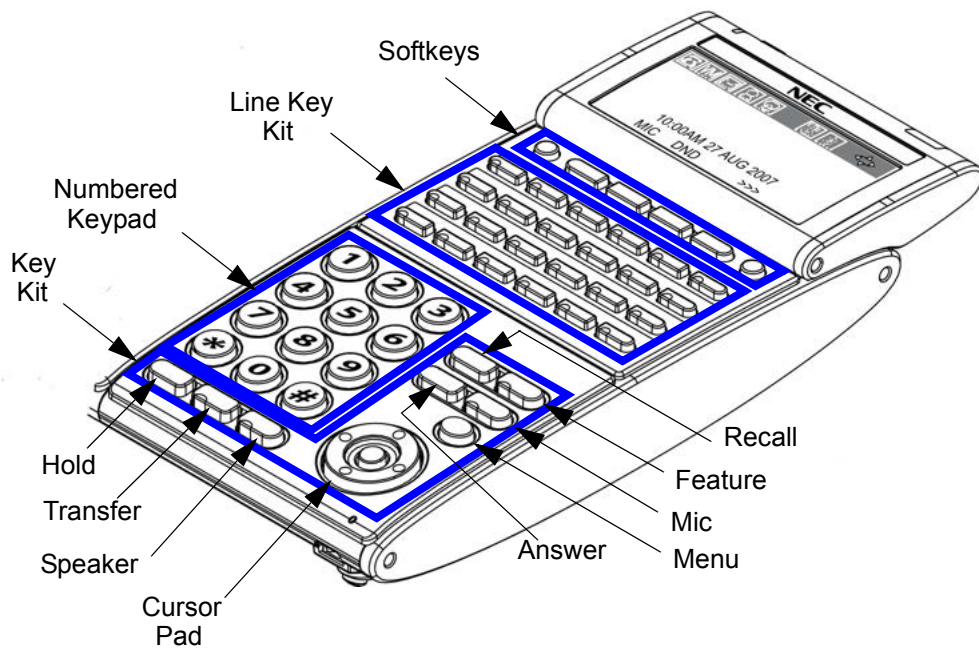

## SECTION 1 ABOUT THIS CHAPTER

This chapter provides an alphabetical listing of the features that are available with the UNIVERGE SV9100 system.

Each feature provides the following information:

**Description** – briefly describes the feature and how it is used.

**Conditions** – provides special operating conditions (if any) that need to be considered with using the feature.

**Default Settings** – indicates the factory default setting (if any).

**System Availability** – describes multiline terminals that can be used with this feature and lists any additional equipment, such as adapters or blades, that must be installed for this feature to operate.

**Programming** – lists the memory blocks that support the feature.

**Related Features** – lists features that are associated with the feature being described (e.g., the Account Codes feature lists the Speed Dialing feature in the related features list because speed dialing bins can contain stored account code (if any)).

**Operation** – provides step-by-step instructions for using the feature.

## SECTION 2 IMPORTANT NOTES

### **Simplifying Multiline Terminal Operation with One-Touch Keys**

A multiline terminal user can access many features using Service Codes (e.g., Service Code 744 sets Call Forward Busy/No Answer). To streamline the operation of their telephone, a multiline terminal user can store these codes under One-Touch Keys. This provides one-button operation for almost any feature. To find out more, turn to the One-Touch Calling and One-Touch Serial Operation features.

### Programmable Keys

When reading an instruction using programmable keys, you will see a notation similar to (PRG 15-07 or SC nnn). This means that the key requires service code nnn, and you can program this code in Program 15-07 or by dialing Service Code 751 or 752. Refer to the Programmable Function Keys feature for more information.

### Using Handsfree

The manual assumes each extension has Automatic Handsfree. This lets a user just press a line key or Speaker key to answer or place a call. For extensions without Automatic Handsfree, the user must:

- Lift the handset or press **Speaker** for Intercom dial tone.
- Lift the handset or press **Speaker**, then press a line key for trunk dial tone.

### Port Assignments

#### Port Calculation for Trunks:

The system detects the type of blade (trunk or extension) and assigns the required extension or trunk ports to the slot. The system will use the next available port numbers – it will not reserve any ports.

## SECTION 3 SV8100 TO UNIVERGE SV9100 FEATURE COMPARISON LIST

Table 2-1 Feature Comparison List provides a cross-reference between the UNIVERGE SV8100 and the UNIVERGE SV9100 features.

Table 2-1 Feature Comparison List

UNIVERGE SV8100 Feature Name	UNIVERGE SV9100 Feature Name
Account Code Entry	Account Code Entry
Account Code – Forced/Verified/Unverified	Account Code – Forced/Verified/Unverified
Alarm	Alarm
Alarm Reports	Alarm Reports
Alphanumeric Display	Alphanumeric Display
Analog Communications Interface (ACI)	Analog Communications Interface (ACI)
Ancillary Device Connection	Ancillary Device Connection
Answer Hold	Answer Hold
Answer Key	Answer Key
Attendant Call Queuing	Attendant Call Queuing
Automatic Release	Automatic Release

Table 2-1 Feature Comparison List (Continued)

UNIVERGE SV8100 Feature Name	UNIVERGE SV9100 Feature Name
Automatic Route Selection (ARS)	Automatic Route Selection (ARS)
Background Music	Background Music
Barge-In	Barge-In
Battery Backup – System Memory	Battery Backup – System Memory
Battery Backup – System Power	Battery Backup – System Power
Callback	Callback
Caller ID Caller Return	Caller ID Caller Return
Caller ID	Caller ID
<i>Not Supported</i>	Caller ID – Flexible Calling Party Number
Caller ID – Flexible Ringing	Caller ID – Flexible Ringing
Caller ID – Memo Display Function	Caller ID – Memo Display Function
Call Appearance (CAP) Keys	Call Appearance (CAP) Keys
Call Arrival (CAR) Keys	Call Arrival (CAR) Keys
Call Duration Timer	Call Duration Timer
Call Forwarding	Call Forwarding
Call Forwarding with Follow Me	Call Forwarding with Follow Me
Call Forwarding – Centrex	Call Forwarding – Centrex
Call Forwarding, Off-Premise	Call Forwarding, Off-Premise
Call Forwarding/Do Not Disturb Override	Call Forwarding/Do Not Disturb Override
Call Monitoring	Call Monitoring
Call Redirect	Call Redirect
Call Waiting/Camp-On	Call Waiting/Camp-On
Central Office Calls, Answering	Central Office Calls, Answering
<i>Not Supported</i>	Central Office Calls, Answering – Auto Attendant Enhancement
<i>Not Supported</i>	Central Office Calls, Answering – Playing MOH During VRS/DISA Transfer
Central Office Calls, Placing	Central Office Calls, Placing
Class of Service	Class of Service
Clock/Calendar Display	Clock/Calendar Display
Code Restriction	Code Restriction
Code Restriction Override	Code Restriction Override

Table 2-1 Feature Comparison List (Continued)

UNIVERGE SV8100 Feature Name	UNIVERGE SV9100 Feature Name
Code Restriction, Dial Block	Code Restriction, Dial Block
Conference	Conference
<i>Not Supported</i>	Conference – Remote
<i>Not Supported</i>	Conference – Remote Conference Recording
Conference, Voice Call/Privacy Release	Conference, Voice Call/Privacy Release
Automatic Call Distribution (ACD)	Contact Center
Continued Dialing	Continued Dialing
Cordless DECT Terminals	Cordless DECT Terminals
Cordless Telephone Connection	Cordless Telephone Connection
CO Message Waiting Indication	CO Message Waiting Indication
Data Line Security	Data Line Security
Delayed Ringing	Delayed Ringing
Department Calling	Department Calling
Department Step Calling	Department Step Calling
Dialing Number Preview	Dialing Number Preview
Dial Pad Confirmation Tone	Dial Pad Confirmation Tone
Dial Tone Detection	Dial Tone Detection
Digital Trunk Clocking	Digital Trunk Clocking
Directed Call Pickup	Directed Call Pickup
Directory Dialing	Directory Dialing
Direct Inward Dialing (DID)	Direct Inward Dialing (DID)
Direct Inward Line (DIL)	Direct Inward Line (DIL)
Direct Inward System Access (DISA)	Direct Inward System Access (DISA)
Direct Station Selection (DSS) Console	Direct Station Selection (DSS) Console
Distinctive Ringing, Tones and Flash Patterns	Distinctive Ringing, Tones and Flash Patterns
Door Box	Door Box
Do Not Disturb	Do Not Disturb
Drop Key	Drop Key
<i>D<sup>term</sup></i> Cordless II Terminal	<i>Not Supported</i>
<i>D<sup>term</sup></i> Cordless Lite II Terminal	<i>Not Supported</i>
DTPlusWare	<i>Not Supported</i>



Table 2-1 Feature Comparison List (Continued)

UNIVERGE SV8100 Feature Name	UNIVERGE SV9100 Feature Name
Ecology	Ecology
Electra Elite IPK Terminals	<i>Not Supported</i>
E911 Compatibility	E911 Compatibility
Facsimile CO Branch Connection	Facsimile CO Branch Connection
Flash	Flash
Flexible System Numbering	Flexible System Numbering
Flexible Timeouts	Flexible Timeouts
Forced Trunk Disconnect	Forced Trunk Disconnect
General Purpose Relay	General Purpose Relay
Group Call Pickup	Group Call Pickup
Group Listen	Group Listen
Handset Mute	Handset Mute
Handsfree and Monitor	Handsfree and Monitor
Handsfree Answerback/Forced Intercom Ringing	Handsfree Answerback/Forced Intercom Ringing
Headset Operation	Headset Operation
Hold	Hold
Hotel/Motel	Hotel/Motel
Hotline	Hotline
Hot Key-Pad	Hot Key-Pad
Howler Tone Service	Howler Tone Service
<i>Not Supported</i>	InControl Call Reporting
VM8000 InMail	InMail
VM8000 InMail – Automatic Access to VM by Caller ID	InMail – Automatic Access to VM by Caller ID
VM8000 InMail – Cascade Message Notification	InMail – Cascade Message Notification
VM8000 InMail – Email Notification	InMail – Email Notification
VM8000 InMail – Find-Me Follow-Me	InMail – Find-Me Follow-Me
VM8000 InMail – Language Setting	InMail – Language Setting
VM8000 InMail Park and Page	InMail – Park and Page
VM8000 InMail Upload Download Audio	InMail – Upload Download Audio
Instant Access Application (IAA)	Instant Access Application (IAA)
Intercom	Intercom
<i>Not Supported</i>	InVPN Server

Table 2-1 Feature Comparison List (Continued)

UNIVERGE SV8100 Feature Name	UNIVERGE SV9100 Feature Name
IP Multiline Station (SIP)	IP Multiline Station (SIP)
<i>Not Supported</i>	IP Multiline Station (SIP) – MLC Mobile
IP Multiline Station (SIP) – ML440 Cordless	IP Multiline Station (SIP) – ML440 Cordless
IP Multiline Station (SIP) – ML440/G566/G266 with AP400/AP300	IP Multiline Station (SIP) – ML440/G566/G266 with AP400/AP300
<i>Not Supported</i>	IP Multiline Telephone (UT880)
IP Single Line Telephone (SIP)	IP Single Line Telephone (SIP)
IP Single Line Telephone (SIP) – NAT Mode	IP Single Line Telephone (SIP) – NAT Mode
IP Trunk – H.323	IP Trunk – H.323
<i>Not Supported</i>	IP Trunk – Multi Gateway Address Support
<i>Not Supported</i>	IP Trunk – TLS Support on SIP Trunk
IP Trunk – (SIP) Session Initiation Protocol	IP Trunk – (SIP) Session Initiation Protocol
IP Video Doorphone	IP Video Doorphone
IP/Digital Call Logging	IP/Digital Call Logging
ISDN Compatibility	ISDN Compatibility
IVR – Appointment Reminder Server	IVR – Appointment Reminder Server
IVR – Broadcast Server	IVR – Broadcast Server
<i>Not Supported</i>	K-CCIS – Call Rerouting
K-CCIS – IP	K-CCIS – IP
K-CCIS – IP with PVA	K-CCIS – IP with PVA
K-CCIS – T1	K-CCIS – T1
Last Number Redial	Last Number Redial
Licensing	Licensing
<i>Not Supported</i>	Line Load Control
Line Preference	Line Preference
Long Conversation Cutoff	Long Conversation Cutoff
Loop Keys	Loop Keys
Maintenance	Maintenance
Meet Me Conference	Meet Me Conference
Meet Me Paging	Meet Me Paging
Meet Me Paging Transfer	Meet Me Paging Transfer
Memo Dial	Memo Dial

Table 2-1 Feature Comparison List (Continued)

UNIVERGE SV8100 Feature Name	UNIVERGE SV9100 Feature Name
Message Waiting	Message Waiting
MH240 Wireless IP Telephone	<i>Not Supported</i>
Microphone Cutoff	Microphone Cutoff
IPK/IPK II Migration	Migration – SV8100/SV8300
<i>Not Supported</i>	Migration – SV9100-S to SV9100-E System
Mobile Extension	Mobile Extension
<i>Not Supported</i>	Mobile Extension – Answer Park Hold
Multiple Trunk Types	Multiple Trunk Types
<i>Not Supported</i>	Multi-Device Support
Music on Hold	Music on Hold
Name Storing	Name Storing
SMB8000 Communications Analyst	NEC Communications Analyst
NEC Meeting Center (NMC)	NEC Meeting Center (NMC)
Night Service	Night Service
Off-Hook Signaling	Off-Hook Signaling
One-Touch Calling	One-Touch Calling
Operator	Operator
(OPX) Off-Premise Extension	(OPX) Off-Premise Extension
Paging, External	Paging, External
Paging, External (VRS)	Paging, External (VRS)
Paging, Internal	Paging, Internal
Park	Park
PBX Compatibility	PBX Compatibility
PC Programming	PC Programming
<i>Not Supported</i>	PC Programming – Security
<i>Not Supported</i>	PC Programming – WebPro HTTPS Support
<i>Not Supported</i>	PhonePro
Power Failure Transfer	Power Failure Transfer
Prime Line Selection	Prime Line Selection
Private Line	Private Line
Programmable Function Keys	Programmable Function Keys
Programming from a Multiline Terminal	Programming from a Multiline Terminal

Table 2-1 Feature Comparison List (Continued)

UNIVERGE SV8100 Feature Name	UNIVERGE SV9100 Feature Name
Pulse to Tone Conversion	Pulse to Tone Conversion
Redial Function	Redial Function
Remote (System) Upgrade	Remote (System) Upgrade
Repeat Redial	Repeat Redial
Resident System Program	Resident System Program
Reverse Voice Over	Reverse Voice Over
<i>Not Supported</i>	RGA Conference
<i>Not Supported</i>	RGA Router
Ringdown Extension, Internal/External	Ringdown Extension, Internal/External
Ring Groups	Ring Groups
Room Monitor	Room Monitor
Save Number Dialed	Save Number Dialed
Secondary Incoming Extension	Secondary Incoming Extension
Secretary Call Pickup	Secretary Call Pickup
Secretary Call (Buzzer)	Secretary Call (Buzzer)
Security	Security
Selectable Display Messaging	Selectable Display Messaging
Selectable Ring Tones	Selectable Ring Tones
Serial Call	Serial Call
<i>Not Supported</i>	Simple MCU Video
Simple Network Management Protocol (SNMP)	Simple Network Management Protocol (SNMP)
Single Line Telephones, Analog 500/2500 Sets	Single Line Telephones, Analog 500/2500 Sets
SLT Adapter	<i>Not Supported</i>
SMB8000 Conference Bridge	<i>Not Supported</i>
SMB8000 Conference Bridge – Outlook Integration	<i>Not Supported</i>
Softkeys	Softkeys
Speed Dial – System/Group/Station	Speed Dial – System/Group/Station
Speed Dial – Telephone Book	Speed Dial – Telephone Book
Station Hunt	Station Hunt
Station Message Detail Recording	Station Message Detail Recording
Station Name Assignment – User Programmable	Station Name Assignment – User Programmable
Station Relocation	Station Relocation

Table 2-1 Feature Comparison List (Continued)

UNIVERGE SV8100 Feature Name	UNIVERGE SV9100 Feature Name
SV8100 Internal Router	<i>Not Supported</i>
<i>Not Supported</i>	SV9100 InGuard
SV8100 NetLink	SV9100 NetLink
SV8100 PoE Gigabit Switch	SV9100 PoE Gigabit Switch
SV8100/SV8300 Terminals	SV9100 Terminals
SV8100 UC Desktop Suite Applications	SV9100 UC Suite
Synchronous Ringing	Synchronous Ringing
<i>Not Supported</i>	System Caller Log
T1 Trunking (with ANI/DNIS Compatibility)	T1 Trunking (with ANI/DNIS Compatibility)
Tandem Ringing	Tandem Ringing
Tandem Trunking (Unsupervised Conference)	Tandem Trunking (Unsupervised Conference)
TAPI Compatibility	TAPI Compatibility
Tone Override	Tone Override
Traffic Reports	Traffic Reports
Transfer	Transfer
Trunk Groups	Trunk Groups
Trunk Group Routing	Trunk Group Routing
Trunk Queuing/Camp-On	Trunk Queuing/Camp-On
UCB (Unified Communications for Business)	<i>Not Supported</i>
UM8000 Mail	UM8000 Mail
uMobility – Server Based	<i>Future</i>
uMobility – Wi-Fi Client	uMobility – Wi-Fi Client
Unicast/Multicast Paging Mode	Unicast/Multicast Paging Mode
Uniform Call Distribution (UCD)	Uniform Call Distribution (UCD)
Uniform Numbering Network	Uniform Numbering Network
Universal Slots	Universal Slots
User Programming Ability	User Programming Ability
<i>Not Supported</i>	Video Conference with WebRTC
Virtual Extensions	Virtual Extensions
<i>Not Supported</i>	Virtual Extensions – Incoming Call History
Voice Call Recording	Voice Call Recording
Voice Mail Integration (Analog)	Voice Mail Integration (Analog)

Table 2-1 Feature Comparison List (Continued)

UNIVERGE SV8100 Feature Name	UNIVERGE SV9100 Feature Name
Voice Mail Message Indication on Line Keys	Voice Mail Message Indication on Line Keys
Voice Over	Voice Over
Voice Response System (VRS)	Voice Response System (VRS)
Voice Response System (VRS) Embedded VRS	<i>Not Supported</i>
Voice Response System (VRS) Upload Download Audio	Voice Response System (VRS) Upload Download Audio
Voice Response System (VRS) – Call Forwarding – Park and Page	Voice Response System (VRS) – Call Forwarding – Park and Page
Volume Controls	Volume Controls
Warning Tone for Long Conversation	Warning Tone for Long Conversation
Wireless DECT (SIP)	Wireless DECT (SIP)

## SECTION 4 FEATURES

The remainder of this document provides the features for the UNIVERGE SV9100 system.

### Description

Account Codes are user-dialed codes that help the system administrator categorize and/or restrict trunk calls. Optional Account Codes allow a user to enter an Account Code while placing a trunk call or anytime while on a call. The system does not require the user to enter the optional account code.

### Account Codes for Incoming Calls

The system can control extension user ability to enter Account Codes for incoming calls. When this option is enabled, a user can dial \* while on an incoming call, enter an Account Code, and then dial \* to return to their caller. If the option is disabled, any digit the user dials after answering an incoming call outdials on the connected trunk.

### Hiding Account Codes

Account Codes can be optionally hidden from a telephone display. This prevents, for example, an unauthorized co-worker from obtaining a Verified Account Code by watching the display. When hidden, the Account Code digits show \* on the telephone display.

### Account Code Capacity

Account Codes print along with the other call data on the SMDR record after the call completes. Account Codes can have 1~16 digits using 0~9 and #.

### Redialed Numbers Do Not Contain Account Codes

When using the Last Number Redial, Save or Repeat Dial features, the system does not retain Account Code information. To redial any number with these features, the user must enter an Account Code.:



NOTE

*If a user enters \*12345\*203 926 5400\*67890\*, if the Last Number Redial feature is used, the system dials the number as 203 926 5400\*67890\*. The \*67890\* is not treated as an Account Code.*

### Conditions

- If a user enters a code that exceeds 16 digits, the system ignores it.
- If the system has Account Codes disabled, the digits dialed (e.g., \*1234\*) appear on the SMDR report as part of the number dialed.
- Do not use an asterisk in a PBX access code when using Account Codes. Otherwise, after the \*, the trunk stops sending digits to the central office.

- Account Codes appear on the SMDR report (even if they are hidden on the telephone display).
- To simplify Account Code Entry, store the Account Code (e.g., 1234) in a One-Touch Key, and press the key instead of dialing the code.
- Speed Dialing bins can contain stored Account Codes. Prevent them from being displayed using Program 35-05-04.
- When Account Codes are enabled, the user must press the \* three times before the \* character is passed to the Telco. The system recognizes the initial \* as the beginning of an Account Code entry, the second \* as the end of an Account Code entry, and the third \* is passed to telco.

### Default Settings

Disabled

## System Availability

### Terminals

All Terminals

### Required Component(s)

None

## Related Features

- ➔ **Automatic Route Selection (ARS)**
- ➔ **One-Touch Calling**
- ➔ **PBX Compatibility**



## Guide to Feature Programming

The **Level 1**, **Level 2** and **Level 3** columns indicate the programs that are assigned when programming this feature in the order they are most commonly used. These levels are used with PCPro and WebPro wizards for feature programming.

- Level 1 – these are the most commonly assigned programs for this feature.
- Level 2 – these are the next most commonly assigned programs for this feature.
- Level 3 – these programs are not often assigned and require an expert level working knowledge of the system to be properly assigned.

Program Number	Program Name/Description	Input Data	Default	Level		
				1	2	3
14-01-11	<b>Basic Trunk Data Setup – Account Code Required</b> Enable/Disable Account Codes for each trunk.	0= Disable (No) 1= Enable (Yes)	1		✓	
15-07-01	<b>Programmable Function Keys</b> Assign a function key as an Account Code key (code 50). Use this key instead of the dial pad to enter the * before and after the Account Code.	Line Key 1 ~ 48 0 ~ 99 (Normal Function Code 751 by default) *00 ~ *99 (Appearance Function Code) (Service Code 752 by default)	Refer to the Programming Manual for default values.		✓	
20-06-01	<b>Class of Service for Extensions</b> Assign a Class of Service (1 ~ 15) to an extension.	Day Night/Mode: 1 ~ 8 Class of Service of Extensions (1 ~ 15)	Extension port 101 = Class 15 All other extension port = Class 1		✓	
21-01-04	<b>System Options for Outgoing Calls – Dial Tone Detection Time</b> Set the time the system waits for the Telco to return Dial Tone.	0 ~ 64800 seconds	5	✓		
35-05-01	<b>Account Code Setup – Account Code Mode</b> Select the Account Code Mode.	0 = Account Codes disabled (None) 1 = Account Codes optional 2 = Account Codes required but not verified (No verify) 3 = Account Codes required and verified (Verify)	0	✓		
35-05-02	<b>Account Code Setup – Forced Account Code Toll Call Setup</b> Enable Account Codes for all calls or just toll calls (for mode 2 or 3 in Program 35-05-01).	0 = Account Codes for toll and local calls (All) 1 = Account Codes just for toll calls (STD)	0		✓	
35-05-03	<b>Account Code Setup – Account Codes for Incoming Calls</b> For each Class of Service (1 ~ 15), enter 1 in this option to Enable Account Codes for incoming calls. Enter 0 to Disable Account Codes for incoming calls. If disabled, any codes you enter dial out on the connected trunk.	0 = Account Codes for incoming calls disabled (No) 1 = Account codes for incoming calls enabled (Yes)	0		✓	

Program Number	Program Name/Description	Input Data	Default	Level		
				1	2	3
35-05-04	<b>Account Code Setup – Hiding Account Codes</b> For each Class of Service (1 ~ 15), enter 1 to have the system hide Account Codes on an extension display as they are entered. Enter 0 to have the Account Codes displayed.	0 = Account Codes not displayed 1 = Account Codes displayed	0		✓	
35-06-01	<b>SMDR Account Code Setup – Verified Account Code</b> Enter Account Codes in the Verification Account Code List. You can enter up to 2000 codes with 3 ~ 16 digits, using the characters 0~9 or #. Use the LK1 to enter a wild card. For example, the entry @234 means the user can enter 0234-9234. ➤ <i>This Program will accept a 1 or 2 digit code but requires a valid input of 3 ~ 16 digits to function.</i>	Maximum of 16 digits. 1 ~ 9, 0, #, @ (@ = Wild card)	No Setting		✓	

## Operation

### To enter an Account Code anytime while on a trunk call:

The outside caller cannot hear the Account Code digits you enter. Use this procedure if your system has Optional Account Codes enabled. You may also use this procedure for incoming calls. This procedure is not available for single line telephones.

1. Dial \*.

- OR -

Press your Account Code key (Program 15-07 or SC 751: code 50).

2. Dial your Account Code (1~16 digits, using 0~9 and #).

◇ *If Account Codes are hidden, each digit you dial shows \* on the telephone display.*

3. Dial \*.

- OR -

Press your Account Code key (Program 15-07 or SC 751: code 50).

### To enter an Account Code before dialing the outside number:

If your system has Forced or Verified Account Codes, you may use this procedure instead of letting the system prompt you for your Account Code. You may also use this procedure if your system has Optional Account Codes.

If your system has Verified Account Codes enabled, be sure to choose a code programmed into your Verified Account Code list.

1. Access trunk for outside call.
  - ◇ *Press a line key or dial a code (except 9) to access a trunk. Refer to [Central Office Calls, Placing on page 2-230](#) for more information.*
2. Dial \*.
- OR -
- Press your Account Code key (Program 15-07 or SC 751: code 50).
3. Dial your Account Code (1~16 digits, using 0~9 and #).
  - ◇ *If you make an incorrect entry, your system may automatically alert the operator. If Account Codes are hidden, each digit you dial shows \* on the telephone display.*
4. Dial \*.
- OR -
- Press your Account Code key (Program 15-07 or SC 751: code 50).
5. Dial the number you want to call.

**To enter an Account Code for an incoming call:**

This procedure is not available for single line telephones.

1. Answer incoming call.
  - ◇ *If Account Codes for Incoming Calls is disabled, the following steps dial digits out to the connected trunk.*
2. Dial \*.
3. Enter the Account Code.
  - ◇ *You can enter any code of the proper length. Incoming Account Codes cannot be Forced or Verified.*
4. Dial \*.

**To enter an Account Code at a single line telephone:**

1. Access trunk for outside call.
  - ◇ *Dial a code to access a trunk. Refer to [Central Office Calls, Placing on page 2-230](#) for more information.*
2. Dial \*
3. Enter Account Code (1~16 digits).
4. Dial \*.
5. Dial number you want to call.

## Account Code - Forced/Verified/Unverified

### Description

Account Codes are user-dialed codes that help the system administrator categorize and/or restrict trunk calls. The system has two types of Forced Account Codes:

#### ❑ Forced Account Codes (Unverified)

Forced Account Codes **require** an extension user to enter an Account Code every time they place a trunk call. If the user does not enter the code, the system prevents the call. As with Account Codes, the extension user can elect to enter an Account Code for an incoming call. However, the system does not require it. **Forced Account Codes do not block emergency assistance (911) calls.**

Once set up in system programming, you can enable Forced Account Codes trunk-by-trunk. In addition, Forced Account Codes can apply to all outside calls or only long distance calls. Forced Account Codes for Toll Calls restricts calls according to the following chart:

Number of Digits Dialed	If first digit is not 1	If first digit is 1
<b>1~3</b>	Not allowed	Not allowed
<b>4~7</b>	Does not require Account Code	Requires Account Code
<b>More than 7</b>	Does not require Account Code	Requires Account Code
<b>800 and 888</b>	Does not require Account Code	Does not require Account Code
<b>011 (International)</b>	Requires Account Code	N/A
<b>911</b>	Does not require Account Code	N/A

#### ❑ Verified Account Codes

With Verified Account Codes, the system compares the Account Code the user dials to a list of up to 2000 programmed codes. If the Account Code is in the list, the call goes through. If the code dialed is not in the list, the system prevents the call. Verified Account Codes can have 3~16 digits using the characters 0~9 and #. During programming, you can use “wild cards” to streamline entering codes into system memory. For example, the entry 123@ lets users dial Verified Account Codes from 1230 through 1239.

### Operator Notification

To prevent Account Code abuse, the system can notify the operator each time an Account Code violation occurs (Program: 20-13-20). This can happen if the user fails to enter an Account Code (if Forced) or enters a Verified Account Code that is not in the list. The notification is an automatic Intercom call to the attendant and a **RESTRICT** message in the operator display.

## Account Codes for Incoming Calls

The system allows extension users to enter Account Codes for incoming calls. When this option is enabled, a user can dial \* while on an incoming call, enter an Account Code, and then dial \* to return to their caller. If the option is disabled, any digit the user dials after answering an incoming call outdials on the connected trunk.

## Hiding Account Codes

Optionally, Account Codes can be hidden from a telephone display. This prevents, for example, an unauthorized co-worker from obtaining a Verified Account Code by watching the display. When hidden, the Account Code digits show as \* on the telephone display.

## Account Code Capacity

Account Codes print along with the other call data on the SMDR record after the call completes. Account Codes can have 1~16 digits using 0~9 and #. Verified Account Codes can have 3~16 digits.

## Redialed Numbers Do Not Contain Account Codes

When using the Last Number Redial, Save or Repeat Dial features, the system does not retain Account Code information. For any number redialed with these features, the user must enter an Account Code.:



NOTE

*If a user enters \*12345\*203 926 5400\*67890\*, if the Last Number Redial feature is used, the system dials the number as 203 926 5400\*67890\*. The \*67890\* is not treated as an Account Code.*

## Conditions

- If a user enters a code that exceeds 16 digits, the system ignores the Account Code Entry.
- If the system has Account Codes disabled, the digits dialed (e.g., \*1234\*) appear on the SMDR report as part of the number dialed.
- If using Forced Account Code with single line telephone you need a VRS to get the prompts to enter the Forced Account Code.
- When you use Forced Account Code on only toll calls, and you dial a local call, you hear a beep.
- The timer set in Program 20-01-14 works when Program 35-05-02 is set to 1 (Apply only toll calls).
- Speed Dial - System/Group/Station bins can contain stored Account Codes. They can be prevented from being displayed using Program 35-05-04.
- To simplify Account Code Entry, store the Account Code (e.g., \*1234\*) in a One-Touch Key. Just press the key instead of dialing the codes.
- Account Codes appear on the SMDR report (even if they are hidden on the telephone display).

- Do not use an asterisk in a PBX/CTX access code when using Account Codes. The \*, causes the trunk to stop sending digits to the central office until another \* is entered.
- Account Codes for incoming calls are not available for single line telephones.
- When using Forced Account Codes (Unverified) for toll calls only, the station follows the timer setting in Program 21-01-14 for all calls.
- System Account codes are bypassed when using DISA trunks. If a user calls in via a DISA trunk, the user is not required to enter an account code.
- When Account Codes are enabled in a Class of Service, extensions in that Class of Service no longer follow the Maximum Dialing Digit setting in the ARS/F-Routes.
- Verified Account Codes for Toll Calls across a CCIS network are not restricted when a trunk access code is added to the number allowing ARS routing through another K-CCIS T1/IP networked site. This access code (typically a 9), precedes the dialed "1" used by the system to identify a long distance call. As a result, the call is no longer considered long distance and the account code is not required.
- Forced Account Codes restrict toll calls based off the digits the system dials, not what the user dials. For example, ARS can be used to manipulate what the user dials. The determination of a toll versus local call is made after ARS has manipulated the number.

## Default Settings

Disabled

## System Availability

### Terminals

All Terminals

### Required Component(s)

VRS for Forced Account Codes for Single Line Telephones

## Related Features

- ➔ **Automatic Route Selection (ARS)**
- ➔ **PBX Compatibility**
- ➔ **Speed Dial – System/Group/Station**
- ➔ **Station Message Detail Recording**

## Guide to Feature Programming

The **Level 1**, **Level 2** and **Level 3** columns indicate the programs that are assigned when programming this feature in the order they are most commonly used. These levels are used with PCPro and WebPro wizards for feature programming.

- Level 1 – these are the most commonly assigned programs for this feature.
- Level 2 – these are the next most commonly assigned programs for this feature.
- Level 3 – these programs are not often assigned and require an expert level working knowledge of the system to be properly assigned.

Program Number	Program Name/Description	Input Data	Default	Level		
				1	2	3
14-01-11	<b>Basic Trunk Data Setup – Account Code Required</b> Enable/Disable Account Codes for each trunk.	0= Disable (No) 1= Enable (Yes)	1		✓	
15-07-01	<b>Programmable Function Keys</b> Assign a function key as an Account Code key (code 50). Use this key instead of the dial pad to enter the * before and after the Account Code.	Line Key 1 ~ 48 0 ~ 99 (Normal Function Code 751 by default) *00 ~ *99 (Appearance Function Code) (Service Code 752 by default)	Refer to the Programming Manual for default values.		✓	
20-06-01	<b>Class of Service for Extensions</b> Assign a Class of Service (1 ~ 15) to an extension.	Day Night/Mode: 1 ~ 8 Class of Service of Extensions (1 ~ 15)	Extension port 101 = Class 15 All other extension port = Class 1		✓	
20-13-20	<b>Class of Service Options (Supplementary Service) – Account Code/Toll Restriction Operator Alert (Restricted Operation Transfer)</b> Turn Off or On the Operator Alert when a forced account code is incorrectly entered.	0 = Off 1 = On	COS 1 ~ 15 = 0		✓	
21-01-14	<b>System Options for Outgoing Calls – Forced Account Code Inter-digit Timer</b> The system waits this time for a user to enter a Forced Account code.	0 ~ 64800 seconds	3		✓	
21-04-01	<b>Toll Restriction Class for Extensions</b> Assign a Toll Restriction Class (1 ~ 15) to an extension.	Day/Night Mode 1 ~ 9 (9 = Power Failure Mode) Restriction Class 1 ~ 15	2		✓	
35-05-01	<b>Account Code Setup – Account Code Mode</b> For each Class of Service (1 ~ 15) select the Account Code Mode.	0 = Account Codes disabled (None) 1 = Account Codes optional 2 = Account Codes required but not verified (No verify) 3 = Account Codes required and verified (Verify)	0	✓		

Program Number	Program Name/Description	Input Data	Default	Level		
				1	2	3
35-05-02	<b>Account Code Setup – Forced Account Code Toll Call Setup</b> Enable Account Codes for all calls or just toll calls (for mode 2 or 3 in Program 35-05-01).	0 = Account Codes for toll and local calls (All) 1 = Account Codes just for toll calls (STD)	0		✓	
35-05-03	<b>Account Code Setup – Account Codes for Incoming Calls</b> For each Class of Service (1 ~ 15), enter 1 in this option to Enable Account Codes for incoming calls. Enter 0 to Disable Account Codes for incoming calls. If disabled, any codes you enter dial out on the connected trunk.	0 = Account Codes for incoming calls disabled (No) 1 = Account codes for incoming calls enabled (Yes)	0		✓	
35-05-04	<b>Account Code Setup – Hiding Account Codes</b> For each Class of Service (1 ~ 15), enter 1 to have the system hide Account Codes on an extension display as they are entered. Enter 0 to have the Account Codes displayed.	0 = Account Codes not displayed 1 = Account Codes displayed	0		✓	
35-06-01	<b>Verified Account Code Table – Verified Account Code</b> Enter data in the Verified Account Code Table. You can enter up to 2000 codes from 3 ~ 16 digits in length. For a wild card @, press the LK 1.  ➡ <i>This Program will accept a 1 or 2 digit code but requires a valid input of 3 ~ 16 digits to function.</i>	Maximum of 16 digits. 1 ~ 9, 0, #, @ (@ = Wild card)	No Setting	✓		
40-10-01	<b>Voice Announcement Service Option – VRS Fixed Message</b> Enable (1) or Disable (0) the system ability to play the fixed VRS messages (such as You have a message).	0 = Not Used 1 = Used	0		✓	

## Operation

### To enter an Account Code anytime while on a trunk call:

The outside caller cannot hear the Account Code digits you enter. Use this procedure if your system has Optional Account Codes enabled. You may also use this procedure for incoming calls. This procedure is not available for single line telephones.

1. Dial \*.
- OR -

Press your Account Code key (Program 15-07-01 or SC 751: code 50).

2. Dial your Account Code (1~16 digits, using 0~9 and #).
  - ◇ *If Account Codes are hidden, each digit you dial shows \* on the telephone display.*



3. Dial \*.

- OR -

Press your Account Code key (Program 15-07-01 or SC 751: code 50).

**To enter a Forced Account Code before dialing the outside number:**

If your system has Forced or Verified Account Codes, you may use this procedure instead of letting the system prompt you for your Account Code. You may also use this procedure if your system has Optional Account Codes.

If your system has Verified Account Codes enabled, be sure to choose a code programmed in your Verified Account Code list.

1. Access trunk for outside call.

◇ *Press a line key or dial a code to access a trunk. Refer to [Central Office Calls, Placing](#) on page 2-230 for more information.*

2. Dial \*.

- OR -

Press your Account Code key (Program 15-07-01 or SC 751: code 50).

3. Dial your Account Code [1~16 digits, using 0~9 and # or (3~16 digits for Forced)].

◇ *If you make an incorrect entry, your system may automatically alert the operator. If Account Codes are hidden, each digit you dial shows \* on the telephone display (depending on programming).*

4. Dial \*.

- OR -

Press your Account Code key (Program 15-07-01 or SC 751: code 50).

5. Dial the number you want to call.

**To dial an outside number and let your system tell you when a Forced Account Code is required:**

1. Access a trunk and dial the number you want to call.

2. Wait for your call to go through.

- OR -

3. If you hear “Please enter an Account Code,” (depending on system programming) and your display shows ENTER ACCOUNT CODE.

Dial \*.

- OR -

Press your Account Code key (Program 15-07-01 or SC 751: code 50).

Dial your Account Code (3~16 digits, using 0~9 and #).

If Account Codes are hidden, each digit you dial shows \* on the telephone display.

Dial \*.

- OR -

Press your Account Code key (Program 15-07-01 or SC 751: code 50).

### To enter an Account Code for an incoming call:

This procedure is not available for single line telephones.

1. Answer incoming call.
  - ◇ *If Account Codes for Incoming Calls is disabled, the following steps dial digits out onto the connected trunk.*
2. Dial \*.
3. Enter the Account Code (1~16 digits).
  - ◇ *You can enter any code of the proper length.*
4. Dial \*.

### To enter a Forced Account Code at a single line telephone:

1. Access trunk for outside call.
  - ◇ *Dial a code to access a trunk. Refer to [Central Office Calls, Placing on page 2-230](#) for more information.*
  - ◇ *With Forced Account Codes, you hear, "Please enter an Account Code." (depending on programming).*
2. Dial \*.
3. Enter Account Code (3~16 digits).
4. Dial \*.
5. Dial number you want to call.

## Description

Alarm lets any station extension work like an Alarm clock. An extension user can have Alarm remind them of a meeting or an appointment. There are two types of Alarms:

- Alarm 1 (sounds only once at the preset time)
- Alarm 2 (sounds every day at the preset time)

### Conditions

- Single line telephones ring and Music on Hold is heard when the Alarm sounds.
- Only a multiline terminal user can view what time the Alarm is currently set for.

### Default Settings

Enabled

## System Availability

### Terminals

All Terminals

### Required Component(s)

None

## Related Features

None

## Guide to Feature Programming

The **Level 1**, **Level 2** and **Level 3** columns indicate the programs that are assigned when programming this feature in the order they are most commonly used. These levels are used with PCPro and WebPro wizards for feature programming.

- Level 1 – these are the most commonly assigned programs for this feature.
- Level 2 – these are the next most commonly assigned programs for this feature.
- Level 3 – these programs are not often assigned and require an expert level working knowledge of the system to be properly assigned.

Program Number	Program Name/Description	Input Data	Default	Level		
				1	2	3
11-11-12	<b>Service Code Setup (for Setup/Entry Operation) – Alarm Clock</b> Customize the alarm clock used for registration and setup.	MLT, SLT 0 ~ 9, *, # Maximum of eight digits	727		✓	
20-01-06	<b>System Options – Alarm Duration</b> Set the duration of the Alarm signal.	0 ~ 64800 seconds	30		✓	

## Operation

### To set the alarm:

1. At the multiline terminal, press **Speaker**.  
- OR -  
At the single line telephone, lift the handset.
2. Dial **727**.
3. Dial alarm type (**1** or **2**).  
◇ *Alarm 1 sounds only once. Alarm 2 sounds each day at the preset time.*
4. Dial the alarm time (24-hour clock).  
◇ *For example, for 1:15 PM dial 1315.  
A confirmation tone is heard if the alarm has been set. If the alarm was not set, an error tone is heard instead.*
5. At the multiline terminal, press **Speaker** to hang up.  
- OR -  
At the single line telephone, hang up.

**To silence an alarm:**

1. At multiline terminal, press **Exit**.

- OR -

At the single line telephone, lift the handset.

◇ *The single line set user hears Music on Hold when the handset is lifted.*

**To check the programmed alarm time at a multiline terminal:**

1. Press **Help**.
2. Dial **727**.
3. Dial alarm type (**1** or **2**).  
◇ *The programmed time displays.*
4. Press **Exit**.

**To cancel an alarm:**

1. At the multiline terminal, press **Speaker**.  
- OR -  
At the single line telephone, lift the handset.
2. Dial **727**.
3. Dial alarm type (**1** or **2**).
4. Dial **9999**.
5. At a multiline terminal, press **Speaker** to hang up.  
- OR -  
At the single line telephone, hang up.

## Alarm Reports

### Description

The UNIVERGE SV9100 system logs various errors and reports information about the operation that can be used to determine the cause of a problem. The system can indicate several errors on the multiline telephone display, output to a USB stick on the GCD-CP10, or be downloaded in PCPro. The report data also can be sent via email.

### Alarm Report

The Alarm Reports indicate:

- System start-up/upgrade date and time
- Blade communication error with date and time and the restoration date and time
- Date and time a blade was removed from the system
- Date and time an extension was disconnected from the system
- Date and time of any system data change

*Table 2-2 Sample Alarm Report*

<< Alarm Report

05/16/2006 14:30 PAGE 001

LVL	NO	STAT	DATE	TIME	ITEM	UNIT	SLT	PRT	PARAMETER
MIN	0002	REC	05/16/06	14:21	PKG Installation	PRT	02	00	
MAJ	0010	ERR	05/16/06	14:21	ISDN Link	PRT	02	12	
MAJ	0010	REC	05/16/06	14:21	ISDN Link	PRT	02	12	
MIN	0002	ERR	05/16/06	14:33	PKG Installation	PRT	02	00	
MIN	0002	ERR	05/16/06	14:33	PKG Installation	ESI	05	00	
MIN	0002	ERR	05/16/06	14:33	PKG Installation	SLIB	07	00	
MAJ	0050	WAR	05/16/06	14:33	System Start Up	none	00	00	
MIN	0002	REC	05/16/06	14:33	PKG Installation	PRT	02	00	
MAJ	0014	ERR	05/16/06	14:33	NTCPU-LAN Link	none	00	00	
MAJ	0014	REC	05/16/06	14:35	NTCPU-LAN Link	none	00	00	
MIN	0002	ERR	05/16/06	14:36	PKG Installation	CTP	08	00	

Table 2-2 Sample Alarm Report (Continued)

<< Alarm Report

05/16/2006 14:30 PAGE 001

LVL	NO	STAT	DATE	TIME	ITEM	UNIT	SLT	PRT	PARAMETER
MIN	0002	REC	05/16/06	14:37	PKG Installation	VMS	08	00	
MIN	0002	ERR	05/16/06	14:38	PKG Installation	VMS	08	00	
MIN	0002	REC	05/16/06	14:40	PKG Installation	PRT	07	00	
MIN	0002	ERR	05/16/06	14:40	PKG Installation	PRT	07	00	
MAJ	0006	ERR	05/16/06	14:41	Blocking	ESIB	01	05	
MAJ	0006	REC	05/16/06	15:01	Blocking	ESIB	01	05	
MAJ	0006	ERR	05/16/06	15:05	Blocking	ESIB	01	07	
MAJ	0006	REC	05/16/06	15:07	Blocking	ESIB	01	07	
MIN	0068	ERR	01/22/09	09:30	VoIP All DSP Busy	VoIPDB	01	00	STA
MIN	0068	ERR	01/22/09	09:31	VoIP All DSP Busy	VoIPDB	01	00	TRK
MIN	0068	ERR	01/22/09	09:35	VoIP All DSP Busy	VoIPDB	01	00	LNK
MIN	0068	ERR	01/22/09	09:40	VoIP All DSP Busy	VoIPDB	01	00	NET

Table 2-3 Alarm Report Definitions

Alarm Report Heading	Definitions
LVL	Alarm Type (MAJ = Major, MIN = Minor)
NO	Number of Alarm (4-digit)
STAT	Status (REC = Recovered, ERR = Error, WAR = Warning)
DATE	Date the Alarm Occurred
TIME	Time the Alarm Occurred
ITEM	Name of the Alarm
UNIT	Name of the Blade
SLT	Chassis Slot Number
PRT	Chassis Port Number
PARAMETER	Related Information

Table 2-4 Alarm Report Item Definitions

Item Name	Definition
PKG Installation	Blade is removed or inserted.
ISDN Link	ISDN Line failure is detected.
GCD-CP10 – LAN Link	GCD-CP10 – LAN connection failure is detected.
Blocking	Terminal Failure may have occurred because terminal blocking is detected. Terminal is unplugged or wire is disconnected.
System Data Change	System Upgrade performed or Programming change.
System Start Up	System is reset.
SMDR Link	Connection failure is detected between the GCD-CP10 and SMDR printer device.
STA	DSP for IP Station Call were all busy.
TRK	DSP for Trunk Call were all busy, includes SIP trunks.
LNK	DSP for Net-Link Call were all busy.
NET	DSP for CCISoIP Networking Call were all busy.

### System Information

The system can print a report of the blades installed, the port assignments, and the port types. This information is sent to the extension defined in Program 90-13.

The System Information Reports indicate:

- Date and Time of the Report
- Blade names
- Slot condition (working, blocked)
- Port assignment
- Port classification

Table 2-5 Sample System Information Printout

System Information				05/18/2006 11:02		
slot	location	type	assign port	condition	note	
1	1-1	DLC	1-16	Running	***** ----- Connect: *	
2	1-2	PRT	1-23	Running		
3	1-3	COT	25-28	Running		



Table 2-5 Sample System Information Printout (Continued)

System Information

05/18/2006 11:02

slot	location	type	assign port	condition	note
4	1-4	none	none	Not Install	
5	1-5	DLC	33-40	Not Install	----- Connect: *
6	1-6	LCA	17-24	Running	
7	1-7	PRT	29-51	Not Install	
8	1-8	VM00	25-32	Running	
9	2-1	none	Not Install		
10	2-2	none	Not Install		
11	2-3	none	Not Install		
12	2-4	none	Not Install		
13	2-5	none	Not Install		
14	2-6	none	Not Install		
15	2-7	none	Not Install		
16	2-8	none	Not Install		
17	3-1	none	Not Install		
18	3-2	none	Not Install		
19	3-3	none	Not Install		
20	3-4	none	Not Install		
21	3-5	none	Not Install		
22	3-6	none	Not Install		
23	3-7	none	Not Install		
24	3-8	none	Not Install		

## Enhancements

- With SV9100 Version 2.00, Alarm indication can lamp (illuminate) a function key for Minor and Major alarms with the error type [ERR]. When a Minor or Major alarm occurs, the function key will light until cleared by the Clear Alarm Report service code (11-10-53) or Program 90-53-01.

## Conditions

- The Alarm Indication Function key is supported on the DT300/400, DT700/800, DSS Console, Softphone, and Bluetooth Cordless Handset.
- Alarm error type [ERR] supports the Alarm Indication Function Key. Types [WAR] and [INF] will not lamp (illuminate) the function key.
- When a major or minor alarm occurs (90-10-01 - 1(MAJ) or 2(MIN)), the Alarm Indication Function key will light solid red. It is cleared with the Clear Alarm Report service code (11-10-53) or with Program 90-53-01.
- Program 20-07-34 must be set to 1 to be able to clear alarms.
- Alarm Reports and System Information Reports can be output to a USB stick on the GCD-CP10.
- The UNIVERGE SV9100 supports the following Alarms to be output to the LCD of a multiline terminal:
  - ❑ SMDR Buffer Full
  - ❑ GCD-CP10-LAN link Error
- The UNIVERGE SV9100 does not support printouts of the following Alarms:
  - ❑ Power Failure
  - ❑ RAM Backup Battery Error
  - ❑ Networking Keep Alive Error
  - ❑ IP Duplication Alarm
- Up to 12 System Alarm times can be scheduled to print on a Monthly, Daily, and Hourly time frame. The report indicates both Major and Minor Alarms.
- System Information Reports cannot be set to output at a scheduled time.
- When using the email functionality of reports, the email address in Program 90-11-10 (From Address) must be set for the email feature to work.
- After a new alarm is output, it cannot be output a second time. New alarms must be generated before Program 90-12-04 can be performed a second time.
- Up to 100 System Alarm Reports can be stored. When the buffer fills, the oldest record is deleted to allow the new record to be saved.
- If the System is set up to email the Alarm Reports and the Mail Server is down, the report is not sent.

- System Information Reports cannot be set for output via email.
- Scheduled Alarm Reports via email prints all alarms. When the system detects New alarms, this information is output via email individually.
- Email Alarm Reports can be sent when each New alarm occurs (Per Event). If you want to receive complete Alarm Reports periodically, you must specify 12 individual dates and times in Program 90-24-01~Program 90-24-04 (per period).
  - ◇ *A maximum of 99 entries are emailed with the scheduled alarms.*
- The DIMLast and DIMDump files are not sent via email when Program 90-03-01 is used to manually generate a data dump. They are only saved on the USB attached to the CCPU.
- Once successfully sent, the DIMLast and DIMDump files are deleted from the system.
- If the email retry limit is exceeded, the DIMLast and DIMDump files are deleted from the system.
- A USB Drive must be mounted to the CCPU for the DIMLast and DIMDump files to be sent via email.
- If Program 90-11-15 is set to 1 (Enable) and no USB drive is mounted to the CCPU, the system will not restart if an error occurs which causes the SV9100 to reboot.
- When attempting a call requiring an IP to TDM conversion and no DSP resource is available, the system displays a message on the multiline terminal and can generate an alarm via the Alarm Report.
- The SV9100 is able to detect another device on the same subnet having an IP address that conflicts with those assigned to the CPU, IPLE, and DSP resources to make troubleshooting easy when IP packets are not sent.
- The SV9100 can be configured to send an email notification of a system event that causes a reset and DIMLast and DIMDump files to be created. The system can also be configured to email the DIMLast and DIMDump text files by using the SMTP email settings in the 47-18-xx programs.
- The Alarm Improvement, where the DIMLast and DIMDump files are sent via email, require the occurrence of a major system event. DIMLast and DIMDump files are not sent for normal alarm events.

## Default Settings

None

## System Availability

### Terminals

All Multiline Terminals

## Required Component(s)

When using the feature to email DIMLast and DIMDump files, the following components are required:

USB memory stick

## Related Features

None

## Guide to Feature Programming

The **Level 1**, **Level 2** and **Level 3** columns indicate the programs that are assigned when programming this feature in the order they are most commonly used. These levels are used with PCPro and WebPro wizards for feature programming.

- Level 1 – these are the most commonly assigned programs for this feature.
- Level 2 – these are the next most commonly assigned programs for this feature.
- Level 3 – these programs are not often assigned and require an expert level working knowledge of the system to be properly assigned.

### Setting Up Alarms:

Program Number	Program Name/Description	Input Data	Default	Level		
				1	2	3
90-10-01	<p><b>System Alarm Setup – Alarm Type</b> Set the alarm type 14 and 60.</p> <p><b>Alarm 14 – GCD-CP10-LAN Link Error (IP Layer 1)</b> Assign a Major or Minor alarm status to the LAN link. This program also assigns whether or not the alarm is displayed to a key telephone and whether or not the alarm information is reported to the predefined destination.</p> <p><b>Alarm 57 – IP Duplication Alarm</b> Assign a Major or Minor alarm status to the IP Duplication Alarm.</p> <p><b>Alarm 60 – SIP Registration Error Notification</b> Assign a Major or Minor alarm status to the SIP Registration Error. This program also assigns whether or not the alarm is displayed to a key telephone and whether or not the alarm information is reported to the predefined destination.</p>	0 = Not Set 1 = Major Alarm 2 = Minor Alarm	0		✓	

Program Number	Program Name/Description	Input Data	Default	Level		
				1	2	3
90-10-02	<b>System Alarm Setup – Report</b> Assign whether or not the alarm is displayed to a multiline terminal and whether or not the alarm information is reported to the predefined destination in Program 90-11.	0 = No Report (no autodial) 1 = Report (autodial)	0		✓	
90-24-01	<b>System Alarm Report Notification Time Setup – Month</b> Set the month for the alarm report to print.	Month 00 ~ 12	00		✓	
90-24-02	<b>System Alarm Report Notification Time Setup – Day</b> Set the day for the alarm report to print.	Day 00 ~ 31	00		✓	
90-24-03	<b>System Alarm Report Notification Time Setup – Hour</b> Set the hour for the alarm report to print.	Hour 00 ~ 23	00		✓	
90-24-04	<b>System Alarm Report Notification Time Setup – Minute</b> Set the minute for the alarm report to print.	Minute 00 ~ 59	00		✓	

**Printing Reports:**

Program Number	Program Name/Description	Input Data	Default	Level		
				1	2	3
90-12-01	<b>System Alarm Output – Output Port Type</b> Indicate the type of connection used for the System Alarms. The baud rate for the COM port should be set in Program 10-21-02.	0 = No Setting 1 = USB Memory	0		✓	

**Printing System Information Reports:**

Program Number	Program Name/Description	Input Data	Default	Level		
				1	2	3
90-13-01	<b>System Information Output – Output Port Type</b> Indicate the type of connection system information.	0 = No Setting 5 = USB	0		✓	

## Emailing Alarm Reports

Program Number	Program Name/Description	Input Data	Default	Level		
				1	2	3
10-12-01	<b>GCD-CP10 Network Setup – IP Address</b> Assign the IP Address.	0.0.0.0 ~ 126.255.255.254 128.0.0.1 ~ 191.255.255.254 192.0.0.1 ~ 223.255.255.254	192.168.0.10	✓		
10-12-02	<b>GCD-CP10 Network Setup – Subnet Mask</b> The setting of Subnet Mask is invalid when all Host Addresses are 0. If the network section is: 0, 127, 128.0, 191.255, 192.0.0, 223.255.255 The setting of Subnet Mask is invalid.	128.0.0.0   192.0.0.0   224.0.0.0  240.0.0.0   248.0.0.0   252.0.0.0  254.0.0.0   255.0.0.0  255.128.0.0   255.192.0.0    255.224.0.0   255.240.0.0  255.248.0.0   255.252.0.0  255.254.0.0   255.255.0.0    255.255.128.0   255.255.192.0  255.255.224.0   255.255.240.0  255.255.248.0   255.255.252.0  255.255.254.0   255.255.255.0    255.255.255.128  255.255.255.192  255.255.255.224  255.255.255.240  255.255.255.248  255.255.255.252  255.255.255.254  255.255.255.255	255.255.255.0		✓	
10-12-03	<b>GCD-CP10 Network Setup – Default Gateway</b> Assign the default gateway IP address for the GCD-CP10.	0.0.0.0 ~ 126.255.255.254 128.0.0.1 ~ 191.255.255.254 192.0.0.1 ~ 223.255.255.254	0.0.0.0		✓	
90-10-02	<b>System Alarm Setup – Report</b> When enabled the system will provide notification of events for each of the enabled reports. This does not have to be set for DIMLast/DIMDump files to be sent.	0 = No Report (no autodial) 1 = Report (autodial)	0		✓	
90-11-02	<b>System Alarm Report – Report Method</b> When Alarm Reports are to be emailed, set this option to 1. Email address set in Program 90-11-08	0 = No Report 1 = Email Address	0		✓	
90-11-06	<b>System Alarm Report – SMTP Host Name</b> When Alarm Reports are to be emailed, set the SMTP name (for example, smtp.yourisp.com). Contact your ISP (Internet Service Provider) for the correct entry if needed.	Maximum of 255 characters	No Setting		✓	
90-11-07	<b>System Alarm Report – SMTP Host Port Number</b> When Alarm Reports are to be emailed, set the SMTP host port number. Contact your ISP (Internet Service Provider) for the correct entry if needed.	0 ~ 65535	25		✓	

Program Number	Program Name/Description	Input Data	Default	Level		
				1	2	3
90-11-08	<b>System Alarm Report – To E-mail Address</b> When Alarm Reports are to be emailed, set this email address to where the report should be sent.	Maximum of 255 characters	No Setting		✓	
90-11-09	<b>System Alarm Report – Reply Address</b> When Alarm Reports are to be emailed, set the email address where replies should be emailed.	Maximum of 255 characters	No Setting		✓	
90-11-10	<b>System Alarm Report – From Address</b> When Alarm Reports are to be emailed, set this email address for the station sending the report.	Maximum of 255 characters	No Setting		✓	
90-11-11	<b>System Alarm Report – DNS Primary Address</b> When Alarm Reports are to be emailed, set the DNS primary address.	0.0.0.0 ~ 255.255.255.255	0.0.0.0		✓	
90-11-12	<b>System Alarm Report – DNS Secondary Address</b> When Alarm Reports are to be emailed, set the DNS secondary address.	0.0.0.0 ~ 255.255.255.255	0.0.0.0		✓	
90-11-13	<b>System Alarm Report – Customer Name</b> When Alarm Reports are to be emailed, enter a name to identify the particular system.	Maximum of 255 characters.	No Setting		✓	
90-25-01	<b>System Alarm Report CC Mail Setup – CC Mail Address</b> Define the mail address to receive the system alarm report CC Mail setup.	Maximum of 255 characters	No Setting		✓	
90-50-01	<b>System Alarm Display Setup – System Alarm Display Telephone</b> Define the extension number that Alarm Reports are displayed on.	Maximum of eight digits	No Setting		✓	

**InMail SMTP Setup:**

Program Number	Program Name/Description	Input Data	Default	Level		
				1	2	3
47-18-01	<b>InMail Setup – SMTP Enabled</b> Enables the SMTP forwarding feature for the system.	0 = No 1 = Yes	0	✓		
47-18-02	<b>InMail Setup – Server Name</b> Sets the SMTP server name. If the DNS server setting is not assigned in Program 90-11-11, the IP Address must be used instead of the name.	Maximum of 48 characters	No Setting	✓		
47-18-03	<b>InMail Setup – SMTP Port</b> Sets the SMTP server port.	0 ~ 65535	25		✓	

Program Number	Program Name/Description	Input Data	Default	Level		
				1	2	3
47-18-04	<b>InMail Setup – Encryption</b> Enable SSL Encryption.	0 = No 1 = Yes	0		✓	
47-18-05	<b>InMail Setup – Authentication</b> Enables authentication, when set to 2 (POP3) refer to Programs 47-19-xx.	0 = No 1 = Yes 3 = POP3	0		✓	
47-18-06	<b>InMail Setup – User Name</b> Set the user name for SMTP authentication.	Maximum of 48 characters	No Setting		✓	
47-18-07	<b>InMail Setup – Password</b> Set the password for SMTP authentication.	Maximum of 48 characters	No Setting		✓	
47-18-08	<b>InMail Setup – E-mail Address</b> Set the email address for the system. This is the “from address” for outgoing emails.	Maximum of 48 characters	No Setting	✓		
47-18-09	<b>InMail Setup – Reply to Address</b> Set the email address for replies to outgoing emails. This email account is not monitored by the system and must be checked manually.	Maximum of 48 characters	No Setting	✓		

**InMail POP3 Setup:**

Program Number	Program Name/Description	Input Data	Default	Level		
				1	2	3
47-19-01	<b>InMail POP3 Setup – Server Name</b> Set the POP3 server name. If the DNS server setting is not assigned in Program 90-11-11 the IP Address must be used instead of the name.	Maximum of 48 characters	No Setting		✓	
47-19-02	<b>InMail POP3 Setup – POP3 Port</b> Set the POP3 server port.	0 ~ 65535	110		✓	
47-19-03	<b>InMail POP3 Setup – SSL Encryption</b> Enable SSL encryption.	0 = No 1 = Yes	0		✓	
47-19-04	<b>InMail POP3 Setup – User Name</b> Set the user name for POP3 authentication.	Maximum of 48 characters	No Setting		✓	
47-19-05	<b>InMail POP3 Setup – Password</b> Set the password for POP3 authentication.	Maximum of 48 characters	No Setting		✓	



**Alarm Indication on Function Key:**

Program Number	Program Name/Description	Input Data	Default	Level		
				1	2	3
11-10-53	<b>Service Code Setup (for System Administrator) – Clear Alarm Report</b> Define the service code used to Clear Alarm Report.	MLT, SLT Maximum of eight digits 0 ~ 9, *, #	No Setting	✓		
15-07-01	<b>Programmable Function Keys</b> Assign #11 for Major Alarm Function key or #12 for Minor Alarm Function key.	Line Key 1 ~ 48 0 ~ 99 (Normal Function Code 751 by default) *00 ~ *99 (Appearance Function Code) (Service Code 751 by default)	Refer to the Programming Manual for default values.	✓		
20-07-34	<b>Class of Service Options (Administrator Level) – Clear Alarm Report</b> Enable or Disable a Class of Service the ability to Clear Alarm Reports.	0 = No 1 = Yes	0	✓		
30-03-01	<b>DSS Console Key Assignment</b> Assign #11 for Major Alarm Function key or #12 for Minor Alarm Function key.	Line Key 1 ~ 48 0 ~ 99 (Normal Function Code 751 by default) *00 ~ *99 (Appearance Function Code) (Service Code 752 by default)	Refer to the Programming Manual for default values.	✓		

**Operation**

**To use this feature at any terminal:**

The user must be logged in with an Installer (IN) level password as defined in Program 90-02.

## Alphanumeric Display

### Description

Multibutton display telephones have a 3-line, 24 character-per-line Alphanumeric Display that provides various feature status messages. These messages help the display telephone user process calls, identify callers and customize features.

#### Conditions

- The contrast is not adjustable when the telephone has background music enabled.

#### Default Settings

Enabled for all display telephones.

### System Availability

#### Terminals

All Multiline Terminals with Display

#### Required Component(s)

None

### Related Features

- ↪ **Clock/Calendar Display**
- ↪ **Selectable Display Messaging**

## Guide to Feature Programming

The **Level 1**, **Level 2** and **Level 3** columns indicate the programs that are assigned when programming this feature in the order they are most commonly used. These levels are used with PCPro and WebPro wizards for feature programming.

- Level 1 – these are the most commonly assigned programs for this feature.
- Level 2 – these are the next most commonly assigned programs for this feature.
- Level 3 – these programs are not often assigned and require an expert level working knowledge of the system to be properly assigned.

Program Number	Program Name/Description	Input Data	Default	Level		
				1	2	3
11-11-13	<b>Service Code Setup (for Setup/Entry Operation) – Display Language Selection for Multiline Terminal</b> If needed, redefine the service code used to select the language for display multiline terminals.	MLT Maximum of eight digits 0 ~ 9, *, #	678		✓	
15-02-01	<b>Multiline Telephone Basic Data Setup – Display Language Selection</b> Select the language to be displayed on a multiline terminal display.	0 = Japanese 1 = English 2 = German 3 = French 4 = Italian 5 = Spanish 6 = Dutch 7 = Portuguese 8 = Norwegian 9 = Danish 10 = Swedish 11 = Turkish 12 = Latin American Spanish 13 = Romanian 14 = Polish	1		✓	
20-06-01	<b>Class of Service for Extensions</b> Assign a Class of Service (1 ~ 15) to an extension.	Day Night/Mode: 1 ~ 8 Class of Service of Extensions (1 ~ 15)	Extension port 101 = Class 15 All other extension port = Class 1		✓	
20-11-08	<b>Class of Service Options (Hold/Transfer Service) – Transfer Information Display</b> Turn Off or On an incoming transfer preanswer display for an extension.	0 = Off 1 = On	COS 1 ~ 15 = 1		✓	

## Operation

Operation is automatic if enabled in programming.

## Analog Communications Interface (ACI)

### Description

The Analog Communications Interface (ACI) feature uses a PGD(2)-U10 ADP (Door Phone/Paging) adapter to provide two analog ports (with associated relays) for Music on Hold, External Paging, Door Boxes and auxiliary devices such as tape recorders and loud bells. The system allows up to 48 PGD(2)-U10 ADPs (when used for ACI ports) for a maximum of 96 analog ports. Each PGD(2)-U10 ADP requires an unused port on a GCD-8DLCA/GCD-16DLCA blade.

### Music on Hold

You can connect up to two customer-provided Music on Hold music sources to a PGD(2)-U10 ADP. This lets you add additional music sources if the external source on the GCD-CP10 ETU or the internal source is not adequate. By using PGD(2)-U10 ADPs, you can even have a different music source for each trunk.

When the system switches the ACI analog port to a trunk on Hold, the PGD(2)-U10 ADP relay associated with the ACI analog port closes. You can use this ability to switch on the music source, if desired.

Extension users can dial the ACI analog port extension number and listen to the connected music source. The PGD(2)-U10 ADP relay associated with the port closes when the call goes through.

For Music on Hold, connect the music source to the PGD(2)-U10 ADP module. Connect the music source control leads to the CTL (control relay) jack.



REFERENCE

Refer to the *UNIVERGE SV9100 System Hardware Manual* for additional details.

### External Paging

An ACI analog port also can be an External Page output. When connected to customer-provided External Paging equipment, the ACI port provides External Paging. To use the External Paging, an extension user just dials the ACI analog port extension number and makes the announcement. The system broadcasts the announcement from the ACI analog port and simultaneously closes the associated PGD(2)-U10 ADP relay. You can use the relay closure to control the External Paging amplifier, if required. This external paging zone is not included in external all call paging or combination paging (internal and external).

For External Paging, connect the Paging amplifier to the PGD(2)-U10 ADP jack. Connect the amplifier control leads to the CTL (control relay) jack.



REFERENCE

Refer to the *UNIVERGE SV9100 System Hardware Manual* for additional details.

## Auxiliary Device Control

The PGD(2)-U10 ADP can control a customer-provided tape recorder. When an extension user dials the ACI analog port extension number, they can automatically start the recorder and activate the record function. When the user hangs up, the recording stops and the tape recorder turns off. For tape recording, connect the tape recorder AUX input jack to the PGD(2)-U10 ADP jack. Connect the recorder control leads (if available) to the CTL (control relay) jack.



REFERENCE

Refer to the *UNIVERGE SV9100 System Hardware Manual* for additional details.

By using Department Calling, you can arrange multiple tape recorders into a pool. When an extension user dials the Department Group pilot number, they reach the first available tape recorder in the pool.

The relays in the PGD(2)-U10 ADP can optionally control customer-provided external ringers (loud bells) and buzzers. When an extension user dials the ACI analog port extension number, the associated PGD(2)-U10 ADP relay closes and activates the ringer. You can use this ability to control an emergency buzzer for a noisy machine shop floor, for example.

## ACI Call Recording

ACI Call Recording allows you to use a recording device connected to a PGD(2)-U10 ADP to automatically record calls. The recording device is typically a customer-provided tape recorder. You can set up ACI Call Recording to output to a single ACI port/recording device or to a pool of ACI ports/devices. With a single device, all calls are stored in a centralized location. With a pool of devices, be sure you have a port available for recording – even in peak traffic periods. You can set up recording per trunk or per extension.

When set up for automatic recording, ACI Call Recording starts automatically when the user places or answers their call. The system can be programmed to record all *incoming* trunk calls which ring an extension. This includes the following trunks:

- Central Office calls programmed to ring the extension
- Direct Inward Dialing (DID)
- Direct Inward Line (DIL)
- Direct Inward System Access (DISA)
- Tie Lines

The system also can be programmed to record *outgoing* trunk calls, however, this is possible only using E&M Tie Lines, PRI or BRI trunks.

ACI Call Recording is not available for intercom calls, transferred calls, or calls placed on hold and answered by an extension with Call Recording enabled. To manually record any call (transferred, ICM, outgoing CO trunk, etc.), use the Voice Mail Conversation Record key (Service Code 751 + 78).

## Physical Ports and Software Ports

Each PGD(2)-U10 ADP has a physical port for connection to the telephone system and two logical ports. For programming, the ports are also called software ports. The physical port connects to a station position on a ESI ETU. During installation, the first PGD(2)-U10 ADP you set up is physical port 1; the second PGD(2)-U10 ADP is physical port 2, etc. Each PGD(2)-U10 ADP has two software ports, which are numbered independently of the physical ports. Normally, the first PGD(2)-U10 ADP set up has software ports 1~2; the second PGD(2)-U10 ADP has software ports 3~4, etc. There are a total of 96 software ports (48 PGD(2)-U10 ADPs x 2 ports each). During programming, you assign ACI extension numbers and Department Group options to PGD(2)-U10 ADP software ports, not physical ports. During installation, you connect equipment to the jacks on the PGD(2)-U10 ADP that correspond to the software port.



REFERENCE

— *Refer to the UNIVERGE SV9100 System Hardware Manual for installation details.*

## Conditions

- Contact Center agents who are logged on can be recorded.
- When ACI software ports are set to be a Background Music source, it only plays to a speaker, not a multiline telephone.
- An extension cannot have Hotline keys for ACI software ports. Music on Hold ACI software ports can be Music on Hold music sources.
- An extension can have One-Touch Keys for ACI software ports. The gives the extension user:
  - One-Touch access to external music
  - One-Touch External Paging
  - One-Touch loud ringer control
- ACI software ports can provide External Paging with control, independent of the External Paging circuits on the GCD-CP10. The PGD(2)-U10 ADP can be connected to any DLC port.
- The devices connected to the PGD(2)-U10 ADP must be compatible with the specifications below.



REFERENCE

— *Refer to the UNIVERGE SV9100 System Hardware Manual for installation details.*

PGD(2)-U10 ADP/ACI Interface Specifications	
<b>Relay Contacts</b>	
Maximum Contact Ratings	30 V DC @ 60 mA
	90 V AC @ 10 mA
Minimum Application Load	1 V DC @ 1 mA
<b>Audio/Music Input</b>	
Input Impedance	47 K Ohms @ 1 K Hz
Maximum Input	0.4Vrms or 1.0Vp-p.
<b>Audio/Paging Output</b>	
Output Impedance	600 Ohms @ 1 K Hz
Maximum Output	+ 3 dBm

### Default Settings

No PGD(2)-U10 ADPs programmed.

### System Availability

#### Terminals

None

#### Required Component(s)

PGD(2)-U10 ADP

### Related Features

- ➔ **Background Music**
- ➔ **Contact Center**
- ➔ **Hotline**
- ➔ **One-Touch Calling**
- ➔ **Paging, External**

## Guide to Feature Programming

The **Level 1**, **Level 2** and **Level 3** columns indicate the programs that are assigned when programming this feature in the order they are most commonly used. These levels are used with PCPro and WebPro wizards for feature programming.

- Level 1 – these are the most commonly assigned programs for this feature.
- Level 2 – these are the next most commonly assigned programs for this feature.
- Level 3 – these programs are not often assigned and require an expert level working knowledge of the system to be properly assigned.

Program Number	Program Name/Description	Input Data	Default	Level		
				1	2	3
10-03-01	<b>ETU Setup (DLCA PKG Setup) – Terminal Type (B1)</b> Assign or display the current terminal type assigned to B Channel 1 for each port on the DLCA.	0 = Not set 1 = Multiline Terminal 3 = Bluetooth Cordless Handset 6 = PGD (Paging) 7 = PGD (Tone Ringer) 8 = PGD (Doorbox) 9 = PGD (ACI) 10 = DSS Console 11 = -- Not Used --	0	✓		
10-03-06	<b>ETU Setup (DLCA PKG Setup) – Terminal Type (B2)</b> Assign or display the current terminal type assigned to B Channel 2 for each port on the ESI.	0 = Not set 6 = PGD(2)-U10 ADP (Paging) 7 = PGD(2)-U10 ADP (Tone Ringer) 8 = PGD(2)-U10 ADP (Door Box) 9 = PGD(2)-U10 ADP (ACI) 12 = APR (B2 Mode)	0	✓		
11-06-01	<b>ACI Extension Numbering</b> Assign extension numbers to ACI software ports. Select a number outside of the normal extension number range.	Maximum of eight digits. ACI Ports: 1 ~ 96	No Setting	✓		
11-08-01	<b>ACI Group Pilot Number</b> Assign pilot numbers to ACI groups. When a user dials the pilot number, they reach an available ACI software port within the group.	Dial (maximum of eight digits). ACI Groups 1 ~ 16	No Setting	✓		
14-09-01	<b>Conversation Recording Destination for Trunks – ACI Recording Destination Extension Number</b> Assign the ACI Call Recording destination per trunk. The destination can be an ACI port extension number (assigned in Program 11-06-01) or an ACI Department Group pilot number (assigned in Program 11-08-01). If destinations are assigned in Program 14-09 and Program 15-12, the destination in Program 15-12 is followed.	Extension Number = Maximum eight digits	No Setting		✓	



Program Number	Program Name/Description	Input Data	Default	Level		
				1	2	3
14-09-02	<p><b>Conversation Recording Destination for Trunks – ACI Automatic Recording for Incoming Calls</b></p> <p>Determine if incoming trunk calls should be automatically recorded in the ACI.</p>	<p>0 = Off 1 = On</p>	0		✓	
15-07-01	<p><b>Programmable Function Keys</b></p> <p>If required, program an ACI Conversation Record Key (code 69 + 0). This key allows an extension user to press the key to manually record a call to the ACI.</p>	<p>Line Key 1 ~ 48 0 ~ 99 (Normal Function Code 751 by default) *00 ~ *99 (Appearance Function Code) (Service Code 752 by default)</p>	Refer to the Programming Manual for default values.		✓	
15-12-01	<p><b>Conversation Recording Destination for Extensions – ACI Recording Destination Extension Number</b></p> <p>Assign the ACI Call Recording destination per extension. The destination can be an ACI port extension number (assigned in Program 11-06) or an ACI Department Group pilot number (assigned in Program 11-08). If destinations are assigned in Program 14-09 and Program 15-12, the destination in Program 15-12 is followed.</p>	Extension Number = Maximum eight digits	No Setting		✓	
15-12-02	<p><b>Conversation Recording Destination for Extensions – ACI Automatic Recording for Incoming Calls</b></p> <p>Determine whether or not an extension should be automatically recorded when an incoming call is received.</p>	<p>0 = Off 1 = On</p>	0		✓	
33-01-01	<p><b>ACI Port Type Setup</b></p> <p>Set each ACI software port for input (1) or input/output (2). Use input ports for Music on Hold sources. Use output ports for External Paging/ringer control.</p>	<p>ACI Ports: 1 ~ 96 ACI Types: 0 = None 1 = MOH/BGM (Input) 2 = External Audio Port (Input/Output)</p>	2	✓		
33-02-01	<p><b>ACI Department Calling Group</b></p> <p>Assign ACI software ports to ACI Department Groups. This lets ACI callers connect to ACI software ports by dialing the group pilot number (set in Program 11-08).</p>	<p>ACI Ports: 1 ~ 96 ACI Groups: 1 ~ 16</p>	<p>ACI Port/Group/ Priority 01/ 1/ 1 02/ 1/ 2 : / : / : 96/ 1/ 96</p>	✓		

## Operation

### To call an ACI software port:

1. Press **Speaker**.
2. Dial ACI software port extension number.

- OR -

Dial ACI Department Group extension number.

- OR -

Press the **One-Touch Key** for ACI extension or Department Group.

### After you call an ACI software port:

- If the port is set for input (Program 33-01-01=1) and a music source is connected, you hear music.
- OR -
- If the port is set for output (Program 33-01-01=2) and External Paging is connected, you can page into the external zone.
- OR -
- If the port is set for output (Program 33-01-01=2) and a loud ringer is connected, you activate the loud ringer.

## Ancillary Device Connection

### Description

Ancillary Device Connection allows installation of selected peripheral (ancillary) devices to a multiline terminal. This feature enhances peripheral device objectives.

An UNIVERGE SV9100 multiline terminal user can accomplish this by using the AP(R)-R/APR-L Unit (Analog Port Adapter with Ringer) or AP(A)-R Unit (Analog Port Adapter without Ringer) for analog telephone devices, or installing the AD(A)-R/APA-L Unit to connect devices such as tape recorders.

The AP(A)-R/AP(R)-R/APA-L Units are the interface for installing a single line telephone, Modem, credit card reader, wireless headset, NEC Conference Max Conferencing unit or other compatible analog device.

The PSA-L Unit (Power Save Adapter), an optional adapter for the ITL/DTL Terminals, is used to make or receive a call using the Public Switched Telephone Network (PSTN) when a call cannot be made with the ITL/DTL extension.

### Conditions

- The optional device fits underneath the terminal.
- A single line telephone connected to an AP(R)-R Unit or AP(A)-R Unit cannot perform Trunk-to-Trunk Transfer and does not support a conference with itself and two outside parties.
- A single line telephone connected to an AP(R)-R Unit or AP(A)-R Unit does not support Message Waiting Indication or Caller ID Indication.
- An AP(R)-R Unit (analog port adapter with ringer) can be installed on a multiline terminal and function separately from the multiline terminal.
- When Program 10-03-06 is assigned as APR you cannot manually assign a port number for an APR. The system uses ports 193~256 (starting with 256 and working down) for a total of 64 APR ports. APR 1 uses port 256, and APR 2 uses port 255, and so on.
- When Program 10-03-06 is assigned as APR you cannot manually assign a port number for the APR.
- Phones that have an APR/APA installed do not pass voice to a trunk until the interdigit time expires (Program 21-01-03).
- When a single line phone is connected to an AP(R)-R or APR-L, a conference cannot be established unless the 2nd channel of ESI is used for APR in Program 10-03-06 and Program 10-03-07.
- When a single line phone is connected to an AP(R)-R or APR-L, the 2nd channel of ESI must be used (Programs 10-03-06 and 10-03-07) to switch back and forth between a call and call waiting.

- APR-L does not support DTL-2E-1, DTL-6E-1, DTZ-2E, DTZ-6DE or all ITZ/ITL style phones.
- ADA-L can send confirmation sound to far end, but the recording machine must generate confirmation sound.

Table 2-6 DT330 Compatibility Settings

ADA-L Unit Switch Settings	Terminal Lot Number DT-330		
	xxx I Lx or lower (Version 1.E0 or lower)	xxx I Mx (Version 8.10)	xxxJSx or higher (Version 2.20 or higher)
ADA Connection for Recording Only.	Dip switches 1, 2, 3, 5, 7 and 8 are OFF. Switches 4 and 6 are ON.	Dip switches 1, 2, 3, 5, 7 and 8 are OFF. Switches 4 and 6 are ON.	Dip switches 1, 2, 3, 5, 7 and 8 are OFF. Switches 4 and 6 are ON.
ADA Connection for Sending Recorded Calls to the Telephone.	Dip switches 2, 3, 5, 7 and 8 are OFF. Switches 1, 4 and 6 are ON.	Dip switches 2, 3, 5, 7 and 8 are OFF. Switches 1, 4 and 6 are ON.	Dip switches 2, 3, 5, 7 and 8 are OFF. Switches 1, 4 and 6 are ON.
To Send and Receive to the Terminal	Not supported	Dip switches 1, 2, 3, 5, 7 and 8 are OFF. Switches 4 and 6 are ON.	Dip switches 1, 2, 3, 5, 7 and 8 are OFF. Switches 4 and 6 are ON.

Lot Numbers: I, J – Hardware Revision  
 Lot Numbers: L, M, S – Software Revision

- *To verify DT-330 terminal firmware, hold down keypad buttons 1, 2 and 3 while plugging the line cord into the terminal.*

Table 2-7 Firmware Compatibility Matrix

		BCH-L Unit Lot Number	
		xxxDxx or lower	xxxExx or higher
<b>Terminal Lot Number DT-330</b>	xxx I xx or lower (Version 8.10 and 1, E0 or lower)	Supported	Supported
	xxxJxx or higher (Version 2.20 or higher)	Not supported	Supported

- *BCH Support may differ based on terminal firmware. To verify both DT-330 terminal and BCH-L Unit firmware, hold down keypad buttons 1, 2 and 3 while plugging the line cord into the terminal.*

## Default Settings

None

## System Availability

### Terminals

All Multiline Terminals

### Required Component(s)

- AP(R)-R
- AP(A)-R
- PSA-L
- ADA-L
- APR-L

## Related Features

➔ [SV9100 Terminals](#)

## Guide to Feature Programming

The **Level 1**, **Level 2** and **Level 3** columns indicate the programs that are assigned when programming this feature in the order they are most commonly used. These levels are used with PCPro and WebPro wizards for feature programming.

- Level 1 – these are the most commonly assigned programs for this feature.
- Level 2 – these are the next most commonly assigned programs for this feature.
- Level 3 – these programs are not often assigned and require an expert level working knowledge of the system to be properly assigned .

Program Number	Program Name/Description	Input Data	Default	Level		
				1	2	3
10-03-03	<b>ETU Setup (LCA PKG Setup) – Transmit Gain Level (S-Level)</b> Customize the transmit and receive levels of the CODEC Gain Types for 500/2500 type single line telephones.	1 ~ 57 (-15.5 +15.5dB)	32 (0dB)	✓		
10-03-04	<b>ETU Setup (LCA PKG Setup) – Receive Gain Level (R-Level)</b> Customize the transmit and receive levels of the CODEC Gain Types for 500/2500 type single line telephones.	1 ~ 57 (-15.5 +15.5dB)	32 (0dB)		✓	

Program Number	Program Name/Description	Input Data	Default	Level		
				1	2	3
15-03-01	<p><b>Single Line Telephone Basic Data Setup – SLT Signaling Type</b></p> <p>Select the type of dialing the connected telephone uses.</p> <p>For the UNIVERGE SV9100 Wireless telephones to function correctly, this must be set to 0. If this option is set for DTMF, after an outside call is placed, the system cannot dial any additional digit.</p> <p>This program change is automatically performed when the UNIVERGE SV9100 Wireless telephone is registered. When upgrading software from prior versions, the previous default of 1 is saved from the prior database so this option must be changed manually.</p>	<p>0 = DP 1 = DTMF</p>	1		✓	
15-03-04	<p><b>Single Line Telephone Basic Data Setup – Flashing</b></p> <p>Enable/Disable Flash for single line (500/2500 type) telephones.</p>	<p>0 = No 1 = Yes</p>	1		✓	

## Operation

Depends on the connected ancillary device.

## Answer Hold

### Description

Answer Hold allows a multiline terminal user to press the flashing Answer Key to answer an incoming ringing call or a Camp-On call. When the multiline terminal user is already answering a call, the first call is automatically placed on hold, depending on the user setting in Program 15-02-06.

### Conditions

- When multiple incoming calls activate the Answer Key LED, the LED continues to flash until all calls are answered.
- Use Program 15-02-06 (Normal Common, Exclusive Hold) to set the type of Hold key to be used (Default = Normal Common).
- For calls placed in a Park Group, the LED blinks fast (green).
- For calls placed in a Park Group by another user, the LED blinks slow (red).
- The Answer Hold Feature is not available for Virtual Extensions.
- The Answer Hold feature does not function for incoming internal calls.
- CO/PBX incoming calls, not assigned to ring or assigned to another ring group, do not activate the Answer Hold feature.
- If the direct trunk appearance key is not assigned when all Call Appearance Keys are in use, the next incoming call cannot be answered.

### Default Settings

Normal Hold

### System Availability

#### Terminals

All Multiline Terminals

#### Required Component(s)

None

## Related Features

- ➔ **Answer Key**
- ➔ **Central Office Calls, Answering**

## Guide to Feature Programming

The **Level 1**, **Level 2** and **Level 3** columns indicate the programs that are assigned when programming this feature in the order they are most commonly used. These levels are used with PCPro and WebPro wizards for feature programming.

- Level 1 – these are the most commonly assigned programs for this feature.
- Level 2 – these are the next most commonly assigned programs for this feature.
- Level 3 – these programs are not often assigned and require an expert level working knowledge of the system to be properly assigned.

Program Number	Program Name/Description	Input Data	Default	Level		
				1	2	3
11-12-32	<b>Service Code Setup (for Service Access) – Answer for Park Hold</b> Assign a key on the multiline terminal or single line telephone for park hold.	MLT, SLT Maximum of eight digits 0 ~ 9, *, #	*6		✓	
15-02-06	<b>Multiline Telephone Basic Data Setup – Hold Key Operating Mode</b> Set the function of the Multiline Hold key. The Hold key can activate normal Hold or Exclusive Hold.	0 = Normal (Common) 1 = Exclusive Hold	0		✓	
15-07-01	<b>Programmable Function Keys</b> Assign a park group to multiline terminal line key.	Line Key 1 ~ 48 0 ~ 99 (Normal Function Code 751 by default) *00 ~ *99 (Appearance Function Code) (Service Code 752 by default)	Refer to the Programming Manual for default values.		✓	
20-09-01	<b>Class of Service Options (Incoming Call Service) – Second Call for DID/DISA/DIL/E&amp;M Override</b> Turn Off or On the extension ability to receive a second call from a DID, DISA, DIL, or tie line caller.  ➔ <i>With this option set to 1, the destination extension must be busy for a second DNIS caller to ring through. If the destination extension does not have a trunk or CAP key available for the second call and a previous call is ringing the extension but has not yet been answered, the second caller hears busy regardless of this program setting.</i>	0 = Off 1 = On	COS 1 ~15 = 1		✓	



## Operation

### To answer a call on a different line key or CAP key with a call in progress:

1. Receive a CO/PBX, DID/DISA/DIL/E&M incoming ring.
  - ◇ *Answer flashes.*
2. Press **Answer**, and answer the new call.
  - ◇ *The Answer LED goes out. The original call is put on hold.*
3. If additional calls are received, press **Answer** to place the current call on hold and connect to the next call as long as Call Appearance Keys and or CO line keys are available.

## Answer Key

### Description

Multiline terminals have an Answer Key with an LED that flashes when the multiline terminal user receives an incoming CO/PBX, Tie/DID transfer, or CO/PBX transfer call. When multiple calls are received, the Answer Key is used to pick up calls and continues flashing until the last unanswered call is answered. Press the Answer Key during a call to hold the current call and allow the next call to be answered.

### Conditions

- The Answer LED functions for incoming CO/PBX calls, CO/PBX transfer/camp-on calls, and transfer/camp-on Tie/DID calls.
- Incoming calls answered by Answer are handled *first in-first out*.
- An Internal call, internal transfer/camp-on call, CAR/SIE/VE calls do not activate the Answer LED.

### Default Settings

None

### System Availability

#### Terminals

All Multiline Terminals

#### Required Component(s)

None

### Related Features

➔ **Answer Hold**

## Guide to Feature Programming

The **Level 1**, **Level 2** and **Level 3** columns indicate the programs that are assigned when programming this feature in the order they are most commonly used. These levels are used with PCPro and WebPro wizards for feature programming.

- Level 1 – these are the most commonly assigned programs for this feature.
- Level 2 – these are the next most commonly assigned programs for this feature.
- Level 3 – these programs are not often assigned and require an expert level working knowledge of the system to be properly assigned.

Program Number	Program Name/Description	Input Data	Default	Level		
				1	2	3
22-02-01	<b>Incoming Call Trunk Setup</b> Assign the incoming trunk type for each trunk.	Incoming Type for Day/Night Mode (1 ~ 8): 0 = Normal 1 = VRS (second dial tone if no VRS installed) 2 = DISA 3 = DID 4 = DIL 5 = E&M Tie line 6 = Delayed VRS 7 = ANI/DNIS 8 = DID(DDI) Mode Switching	0		✓	
22-04-01	<b>Incoming Extension Ring Group Assignment</b> Assign extensions (up to 48) to Ring Groups. Calls ring extensions according to Ring Group programming. There are 100 available ring groups.	Maximum eight digits	Extensions 101 ~ 108 (first eight ports) ring for incoming Ring Group 1 calls. No other extensions ring for incoming Ring Group 1 calls.		✓	
22-05-01	<b>Incoming Trunk Ring Group Assignment</b> Use this program to assign Normal Ring Trunks (Program 22-02) to Incoming Ring Groups (Program 22-04).	Trunks 1 ~ 400 Incoming Group Number for Day/Night Mode (1 ~ 8): 0 = (No Setting) 001 ~ 100 = (Incoming Group) 102 = (In-Skin/ External Voice Mail or InMail)	1		✓	
22-07-01	<b>DIL Assignment</b> Assign the destination extension or Department Group Pilot Number for each DIL Incoming trunk. ➡ For this selection to work, set Program 22-02-01 to 4 (DIL).	Day/Night Modes (1 ~ 8): Extension Number (maximum of eight digits) Pilot Number	No Setting		✓	

## Operation

### To answer calls using the Answer Key:

1. Receive CO/PBX incoming ring.
2. Press **Answer**.
3. Talk with the CO/PBX incoming calling party.
4. When additional CO incoming calls are received, press **Answer** to place the current call on hold and connect the multiline terminal user to the next call.

## Attendant Call Queuing

### Description

Attendant extensions can have up to 32 incoming calls queued before additional callers hear a busy tone. This helps minimize call congestion in systems that use the attendant as the overflow destination for unanswered calls. For example, you can program Direct Inward Lines and Voice Mail calls to route to the attendant when their primary destination is busy. With Attendant Call Queuing, unanswered calls would normally “stack up” for the attendant until they can be processed.

The 32 call queue total includes Intercom, DISA, DID, DIL, Tie Line and transferred calls. If the attendant does not have an appearance for the queued call, it waits in line to be answered. If the attendant has more than 32 calls queued, an extension can transfer a call to the attendant only if they have Busy Transfer enabled.

Attendant Call Queuing is a permanent, non-programmable system feature.

### Conditions

- Forwarding when unanswered or busy can occur only at the attendant if more than 32 calls are in queue.
- Assigning a station as operator in Program 20-17-01 enables call queuing function.
- Program 20-17-01 setting overrides setting in Program 20-09-07: Call Queuing Class of Service Option when set to disable.

### Default Settings

Enabled

### System Availability

#### Terminals

All Multiline Terminals assigned as an operator

#### Required Component(s)

None

### Related Features

↳ [Call Forwarding](#)

## Guide to Feature Programming

The **Level 1**, **Level 2** and **Level 3** columns indicate the programs that are assigned when programming this feature in the order they are most commonly used. These levels are used with PCPro and WebPro wizards for feature programming.

- Level 1 – these are the most commonly assigned programs for this feature.
- Level 2 – these are the next most commonly assigned programs for this feature.
- Level 3 – these programs are not often assigned and require an expert level working knowledge of the system to be properly assigned.

Program Number	Program Name/Description	Input Data	Default	Level		
				1	2	3
11-01-01	<b>System Numbering – Service Code</b>	Set the system internal (Intercom) numbering plan. The numbering plan assigns the first and second digits dialed and affects the digits an extension user must dial to access other extensions and features, such as service codes and trunk codes. If the default numbering plan does not meet the site requirements, use this program to tailor the system numbering to the site.	Refer to the Programming Manual for default values.	✓		
20-01-01	<b>System Options – Operator Access Mode</b> Assign the priority of a call when calling an operator telephone.	0 = Step 1 = Circular	0	✓		
20-09-07	<b>Class of Service Options (Incoming Call Service) – Call Queuing</b> Turn Off or On an extension user ability to have calls queued if a call rings the extension when it is busy. ➡ Program 20-13-06 must be set to 0 (Off) for this feature to work.	0 = Off 1 = On	COS 1 ~ 15 = 1		✓	
20-17-01	<b>Operator Extension – Operator’s Extension Number</b> Define the extension numbers which are to be used by operators.	Maximum of eight digits	Extension 101	✓		
24-02-01	<b>System Options for Transfer – Busy Transfer</b> Enable/Disable extensions to Transfer calls to busy extensions. If disabled, calls transferred to busy extensions recall immediately.	0 = Disable (No) 1 = Enable (Yes)	1		✓	

## Operation

None

## Automatic Release

### Description

Automatic Release drops the line circuit when an outside party abandons the call. For this feature to work with Loop Start Trunks, the CO/PBX providing the outside line must provide a timed disconnect signal. Automatic Release is normally provided on Ground Start, DID, ISDN, and Tie Line trunks.

### Conditions

- Automatic Release on ISDN trunks is provided by the protocol.
- When an outside line is accessed using a dedicated line key, the LED associated with the line key goes off when Automatic Release occurs.
- This feature functions while a call is in progress, on hold, or in a conference.
- This feature applies to all ICM type calls in progress, holding or parked.
- When Automatic Release occurs and the telephone is in handsfree mode, **Speaker** automatically turns off. If using the handset, the station is set to idle when the handset goes on-hook.

### Default Settings

None

### System Availability

#### Terminals

None

#### Required Component(s)

None

### Related Features

- ➔ **Central Office Calls, Answering**
- ➔ **Central Office Calls, Placing**

## Guide to Feature Programming

The **Level 1**, **Level 2** and **Level 3** columns indicate the programs that are assigned when programming this feature in the order they are most commonly used. These levels are used with PCPro and WebPro wizards for feature programming.

- Level 1 – these are the most commonly assigned programs for this feature.
- Level 2 – these are the next most commonly assigned programs for this feature.
- Level 3 – these programs are not often assigned and require an expert level working knowledge of the system to be properly assigned.

Program Number	Program Name/Description	Input Data	Default	Level		
				1	2	3
14-02-09	<b>Analog Trunk Data Setup – Busy Tone Detection</b> Enable/Disable Busy Tone Detection.	0 = Disable (No) 1 = Enable (Yes)	0		✓	
14-02-14	<b>Analog Trunk Data Setup – Loop Start/ Ground Start</b> Identify the analog trunk as either loop or ground start.	0 = Loop Start (Loop) 1 = Ground Start (Ground)	0			✓
80-04-01	<b>Call Progress Tone Detector Setup – Detection Level</b> Set the Detection Level.	0 = 0dBm ~ -25dBm 1 = -5dBm ~ -30dBm 2 = -10dBm ~ -35dBm 3 = -15dBm ~ -40dBm 4 = -20dBm ~ -45dBm 5 = -25dBm ~ -50dBm 6 = -30dBm ~ -55dBm	Type 1 (DT) – 0 (-25dBm) Type 2 (BT) – 0 (-25dBm) Type 3 (RBT) – 0 (-25dBm) Type 4, Type 5 – 0			✓
80-04-02	<b>Call Progress Tone Detector Setup – Min. Detection Level</b> Set the minimum detection level.	0 ~ 15 detect level 0: -15dBm (0) to -30dBm(15) detect level 1: -30dBm (0) to -45dBm(15) detect level 2: -40dBm (0) to -55dBm(15)	<b>Version 1000</b> Type 1 (DT) – 15 (-25dBm) Type 2 (BT) – 15 (-25dBm) Type 3 (RBT) – 15 (-25dBm) Type 4, Type 5 – 0			✓
			<b>Version 3000 or higher</b> Type 1 (DT) – 15 (-25dBm) Type 2 (BT) – 15 (-25dBm) Type 3 (RBT) – 15 (-25dBm) Type 4 – 0 Type 5 – 1			



Program Number	Program Name/Description	Input Data	Default	Level		
				1	2	3
80-04-03	<b>Call Progress Tone Detector Setup – S/N Ratio</b> Set the Signal to Noise ratio.	0 ~ 4 (0dB ~ -20dB)	Type 1 (DT) = 4 (-20dB) Type 2 (BT) = 4 (-20dB) Type 3 (RBT) = 4 (-20dB) Type 4 = 0 Type 5 = 0			✓
80-04-04	<b>Call Progress Tone Detector Setup – No Tone Time</b> Set No Tone Time.	0 ~ 255 (30 + 30 ~ 7680ms) (0 = not detect) 1 ~ 255 = 60 ~ 7680ms The formula is 30 + 30N. When set to N = 1, it means 30 + 30 * 1 = 60. When set to N=255, it means 30+30*255=7680	Type 1 (DT) – 132 (3990ms) Type 2 (BT) – 132 (3990ms) Type 3 (RBT) – 132 (3990ms) Type 4, Type 5 – 0			✓
80-04-05	<b>Call Progress Tone Detector Setup – Pulse Count</b> Set the Pulse Count.	1 ~ 255	Type 1 (DT) – 1 Type 2 (BT) – 1 Type 3 (RBT) – 1 Type 4, Type 5 – 0			✓
80-04-06	<b>Call Progress Tone Detector Setup – ON Minimum Time</b> Set the minimum On time.	1 ~ 255 (30 + 30 ~ 7680ms)	<b>Version 1000</b> Type 1 (DT) – 9 (300ms) Type 2 (BT) – 12 (300ms) Type 3 (RBT) – 25 (780ms) Type 4, Type 5 – 0  <b>Version 3000 or higher</b> Type 1 (DT) – 45 (300ms) Type 2 (BT) – 12 (300ms) Type 3 (RBT) – 25 (780ms) Type 4 – 0 Type 5 – 5			✓

Program Number	Program Name/Description	Input Data	Default	Level		
				1	2	3
80-04-07	<b>Call Progress Tone Detector Setup – ON Maximum Time</b> Set the maximum On time.	0 ~ 255 (30 + 30 ~ 7680ms)	<b>Version 1000</b> Type 1 (DT) – 0 Type 2 (BT) – 20 (630ms) [ET] Type 3 (RBT) – 40 1230ms Type 4, Type 5 – 0			
			<b>Version 3000 or higher</b> Type 1 (DT) – 0 Type 2 (BT) – 20 (630ms) [ET] Type 3 (RBT) – 40 1230ms Type 4 – 0 Type 5 – 15			✓
80-04-08	<b>Call Progress Tone Detector Setup – OFF Minimum Time</b> Set the minimum Off time.	1 ~ 255 (30 + 30 ~ 7680ms)	Type 1 (DT) – 1 (60ms) Type 2 (BT) – 12 (390ms) Type 3 (RBT) – 83 (2520ms) Type 4, Type 5 – 0			✓
80-04-09	<b>Call Progress Tone Detector Setup – OFF Maximum Time</b> Set the maximum Off time.	0 ~ 255 (30 + 30 ~ 7680ms)	Type 1 (DT) – 1 (60ms) Type 2 (BT) – 20 (630ms) Type 3 (RBT) – 115 (3480ms) Type 4, Type 5 – 0			✓

### Operation

None

## Automatic Route Selection (ARS)

### Description

Automatic Route Selection (ARS) provides call routing and call restriction based on the digits a user dials. ARS gives the system the most cost-effective use of the connected long distance carriers.

ARS is an on-line call routing program that you can customize (like other system options) from a display telephone. ARS accommodates 2000 call routing choices – without a custom-ordered rate structure database. With ARS, you can modify the system routing choices quickly and easily. This is often necessary in the telecommunications world of today where the cost structure and service choices frequently change.

The ARS feature can add or delete digits and route calls according to predetermined levels. When UNIVERGE SV9100 systems are networked together by Tie Lines or K-CCIS, the networked systems can be called by a system number and a user extension number, just an extension number, or by using a trunk access code.

### ARS Feature Summary

ARS provides:

- Call Routing  
ARS can apply up to 24-digit analysis to every number dialed. For programming, ARS provides separate 8-digit and 24-digit tables. Each table can have up to 250 numbers.
- Dialing Translation (Special Dialing Instructions)  
ARS can automatically execute stored dialing instructions (called Dial Treatments) when it chooses a route for a call. The system allows up to 15 Dial Treatments. The Dial Treatments can:
  - Insert or delete an area code (NPA)
  - Add digits (such as a dial-up OCC number), pauses and waits to the dialing sequence
  - Require the user to enter an authorization code when placing a call (refer to Program 44-03)
- Time of Day Selection  
For routing, ARS provides 10 different day selections (called Time Schedule Patterns). Each Time Schedule Pattern can provide up to 20 time intervals which are assigned to one of the eight day/night modes. The Time Schedule Patterns are then assigned to a day of the week (Monday~Friday, Saturday, Sunday or Holiday).
- Hierarchical Class of Service Control  
ARS allows or denies call route choices based on an extension ARS Class of Service. This allows lower Classes of Service (e.g., 1) to access routes unavailable to higher Classes of Service (e.g., 16). The system provides up to 16 (0=unrestricted, 1~16) ARS Classes of Service.

- ❑ **Separate Routing for Selected Call Types**  
To provide unique control, you can program separate routing instructions for:
  - Directory assistance (411, 1411 and 555) calls
  - Emergency (911) calls
- ❑ **Separate Routing for Equal Access (1010XXX) Calls**  
Choose different routing for directly-dialed (1010XXX + 1) and operator-assisted (1010XXX + 0) Equal Access calls.

**Basic ARS Operation**

When a user places an outside call, ARS analyzes the digits dialed and assigns one of 2000 Selection Numbers to the call. The Selection Number chosen depends on which digits the user dialed. ARS then checks the time of day, the day of week and the extension ARS Class of Service. Based on these call routing options, ARS selects a trunk group for the call and imposes the Dial Treatment instructions (if any).

**Class of Service Option Allows Outgoing Calls to Not Follow Access Map**

Using this option allows a Class of Service to be set so that ARS does not follow the trunk access map settings (Program 14-07-01 and Program 15-06-01). The feature allows an extension user to have CO line keys on their telephone which allow incoming access only. The user has only outgoing access on the CO lines when using ARS to place a call.

**Class of Service Matching**

With the ARS Class of Service Match Access feature, you can determine whether the system should allow a call based on the COS assigned to the Dial Analysis Table (Program 26-02). This change can be used to create a tenant-like application. It then uses the trunk group defined in the Additional Entry in Program 26-02-03 to place the outgoing call.

When this feature is enabled, the calls are routed in sequential order, and are allowed if the Class of Service for the trunk group matches.

For this feature, **Program 26-01-06: Automatic Route Selection Service, COS Match Access** is used.

The examples below use the following system programming:

**Program 26-02 for Dial Analysis Table for ARS set as:**

Table No.	Program 26-02-01 Dial	Program 26-02-02 Service Type	Program 26-02-03 Add Data	Program 26-02-04 ARS COS
1	203@@@@@	1:Route to trunk group	3 (Group 3)	5
2	214@@@@@	1:Route to trunk group	1 (Group 1)	4
197	@@@@@@@@	1:Route to trunk group	2 (Group 2)	4
198	@@@@@@@@	1:Route to trunk group	3 (Group 3)	3
199	@@@@@@@@	1:Route to trunk group	2 (Group 2)	2

**Program 26-02 for Dial Analysis Table for ARS set as:**

Table No.	Program 26-02-01 Dial	Program 26-02-02 Service Type	Program 26-02-03 Add Data	Program 26-02-04 ARS COS
200	@@@@@@@@@@	1:Route to trunk group	1 (Group 1)	1

**Program 12-02 for Automatic Night Service Patterns as:**

Time Pattern No.	Program 12-02-01 Start Time	Program 12-02-02 End Time	Program 12-02-03 Operation Mode
1	00:00	08:30	2 (Night)
2	08:30	17:00	1 (Day)
3	17:00	00:00	2 (Night)

**Program 12-02 for Automatic Night Service Patterns as:**

Mode	Ext. 301	Ext. 302	Ext. 401	Ext. 402
Mode 1 (Day)	1	2	3	3
Mode 2 (Night)	1	4	3	5

**Program 26-01-03 for ARS Misdialed Number Handling as: 1 (Warning Tone)**

**With Program 26-01-06: ARS COS Match Access disabled (set to 0):**

- If at 9:00 AM, each extension dialed 9+(203)926-5400  
All Extension would use Trunk Group 3
- If at 9:00 AM, each extension dialed 9+(214)262-2000  
All Extension would use Trunk Group 1
- If at 6:00 PM, each extension dialed 9+(203)926-5400  
All Extension would use Trunk Group 3
- If at 6:00 PM, each extension dialed 9+(214)262-2000  
Extension 301, 302 and 401 would use Trunk Group 1  
Extension 402 would not be able to dial out as the COS is lower

**With Program 26-01-06: ARS COS Match Access enabled (set to 1):**

- If at 9:00 AM, each extension dialed 9+(203)926-5400  
Extension 301 would use Trunk Group 1  
Extension 302 would use Trunk Group 2  
Extension 401, 402 would use Trunk Group 3
- If at 9:00 AM, each extension dialed 9+(214)262-2000  
Extension 301 would use Trunk Group 1  
Extension 302 would use Trunk Group 2  
Extension 401, 402 would use Trunk Group 3

- ❑ If at 6:00 PM, each extension dialed 9+(203)926-5400  
Extension 301 would use Trunk Group 1  
Extension 302 would use Trunk Group 2  
Extension 401, 402 would use Trunk Group 3
- ❑ If at 6:00 PM, each extension dialed 9+(214)262-2000  
Extension 301, 302 would use Trunk Group 1  
Extension 401 would use Trunk Group 3  
Extension 402 would not be able to dial out as the COS does not match

## Conditions

- ARS is intended for areas that use the North American Number Plan (NANP).
- Line keys, Call Appearance (CAP) Keys, outgoing trunk group keys, dialing 704 + trunk group, dialing +trunk number, and speed dial numbers assigned to a certain trunk group can all be used to by-pass ARS.
- If no PBX access code is entered in the Dial Treatment, the system can still dial 911.
- Toll Restriction overrides ARS.
- A system with Automatic Route Selection (ARS) cannot also have Trunk Group Routing.
- With ARS installed, Trunk Queuing automatically queues for the least costly route. The system automatically redials the queued call when the extension user lifts the handset.
- Speed Dialing may bypass ARS routing.
- Set up other options for outgoing calls (e.g., unassign line keys, adjust gains, ARS access key, Call Appearance (CAP) Keys, etc.).
- Refer to [Dial Tone Detection on page 2-404](#) feature for the specifics on how the system handles Dial Tone Detection.
- ARS does not permit 0 and 011+ calls to be routed out separate trunk groups. The UNIVERGE SV9100 supports only direct trunk selection for dial 0 (Operator) type calls.
- If an entry of 911 is programmed in ARS, but ARS is turned off, 911 calls still attempt to route using ARS.
- When using ARS Class of Service Matching, CCIS calls will always follow Class of Service 1.
- If a user dials a number not programmed in ARS, Program 26-01-03 determines if the system should route over the trunk group settings defined in Program 21-02 or play an error tone.
- When using ARS Class of Service, with Program 26-01-03 set to (1) "Play Warning Tone", any trunk (except a CCIS trunk) pointed or transferred to a virtual that is Call Forward Off-Premise will not complete. For a virtual to Call Forward Off-Premise, Program 26-01-03 must be set to "Route to trunk group" and the call will follow the trunk group settings of the trunk, assigned in Program 21-03.

- When using ARS Class of Service, with Program 26-01-03 set to (1) “Play Warning Tone”, a CCIS trunk pointed or transferred to a virtual that is call forwarded off premise will always follow ARS Class 1 routing properties.

### Default Settings

Disabled

## System Availability

### Terminals

None

### Required Component(s)

None

## Recognize Extension Location when Logging in with NetLink

### Description

The SV9100 can recognize each system where the DT700/DT800 extension(s) are connected then provide an Automatic Route Selection (ARS) COS based on the System (System ID) when using NetLink.

#### Conditions

- This feature requires Netlink to be enabled.
- This feature is only supported on DT700/DT800 and Softphones.

#### Default Settings

None

### System Availability

#### Terminals

DT700/DT800

#### Required Component(s)

Refer to [SV9100 NetLink on page 2-1523](#) for Required Component(s)

### Related Features

- ↪ [Central Office Calls, Placing](#)
- ↪ [Code Restriction](#)
- ↪ [Dial Tone Detection](#)
- ↪ [E-911 Compatibility](#)
- ↪ [Speed Dial – System/Group/Station](#)
- ↪ [SV9100 NetLink](#)
- ↪ [Trunk Group Routing](#)
- ↪ [Trunk Queuing/Camp-On](#)



## Guide to Feature Programming

The **Level 1**, **Level 2** and **Level 3** columns indicate the programs that are assigned when programming this feature in the order they are most commonly used. These levels are used with PCPro and WebPro wizards for feature programming.

- Level 1 – these are the most commonly assigned programs for this feature.
- Level 2 – these are the next most commonly assigned programs for this feature.
- Level 3 – these programs are not often assigned and require an expert level working knowledge of the system to be properly assigned.

### Automatic Route Selection:

Program Number	Program Name/Description	Input Data	Default	Level		
				1	2	3
11-01-01	<b>System Numbering</b>	Set the system internal (Intercom) numbering plan. The numbering plan assigns the first and second digits dialed and affects the digits an extension user must dial to access other extensions and features, such as service codes and trunk codes. If the default numbering plan does not meet the site requirements, use this program to tailor the system numbering to the site.	Refer to SV9100 Programming Manual for a detailed description of this program.	✓		
11-09-01	<b>Trunk Access Code</b> Specify the digit or digits to be used to access ARS (normally 9).	Dial up to four digits.	9		✓	
11-09-02	<b>2nd Trunk Route Access Code</b> Define additional trunk access codes. When a user dials the Alternate Trunk Route Access Code, the system routes their call to the Alternate Trunk Route.	Dial up to four digits.	No Setting		✓	
12-01-01	<b>Night Mode Function Setup – Manual Night Mode Switching</b> Turn Off or On any extension from activating Manual Night Service.	0 = Off 1 = On	1		✓	
12-01-02	<b>Night Mode Function Setup –Automatic Night Mode Switching</b> According to a preset schedule, Enable (1)/ Disable (0) Automatic Night Service for the system. Make sure to set the Service Patterns in Program 12-02-01, Program 12-02-02 and Program 12-02-03.	0 = Off 1 = On	0		✓	

Program Number	Program Name/Description	Input Data	Default	Level		
				1	2	3
12-02-01	<p><b>Automatic Night Service Patterns –Start Time</b></p> <p>Define the daily pattern of the Automatic Mode Switching. Each Mode Group has 10 patterns. These patterns are used in Programs 12-03 and 12-04. The daily pattern consists of 20 timer settings.</p> <p>This option defines the starting time.</p>	0000 ~ 2359	Refer to the Programming Manual for default values.		✓	
12-02-02	<p><b>Automatic Night Service Patterns –End Time</b></p> <p>Define the daily pattern of the Automatic Mode Switching. Each Mode Group has 10 patterns. These patterns are used in Programs 12-03 and 12-04. The daily pattern consists of 20 timer settings.</p> <p>This option defines the ending time.</p>	0000 ~ 2359	Refer to the Programming Manual for default values.		✓	
12-02-03	<p><b>Automatic Night Service Patterns – Operation Mode</b></p> <p>Define the daily pattern of the Automatic Mode Switching. Each Mode Group has 10 patterns. These patterns are used in Programs 12-03 and 12-04. The daily pattern consists of 20 timer settings.</p> <p>This option defines the operation mode that the system should be in during each time number.</p>	1 ~ 8	1 or 2 (depending on time pattern and time number)		✓	
12-03-01	<p><b>Weekly Night Service Switching</b></p> <p>Define which time pattern should be used on each day of the week.</p>	<p>Night Mode Service Group Numbers: 01 ~ 32</p> <p>Time Schedule Pattern Number: 1 ~ 10</p> <p>Day of Week:</p> <p>01 = Sunday</p> <p>02 = Monday</p> <p>03 = Tuesday</p> <p>04 = Wednesday</p> <p>05 = Thursday</p> <p>06 = Friday</p> <p>07 = Saturday</p>	<p>01 = Sunday (default = Time Pattern 2)</p> <p>02 = Monday (default = Time Pattern 1)</p> <p>03 = Tuesday (default = Time Pattern 1)</p> <p>04 = Wednesday (default = Time Pattern 1)</p> <p>05 = Thursday (default = Time Pattern 1)</p> <p>06 = Friday (default = Time Pattern 1)</p> <p>07 = Saturday (default = Time Pattern 2)</p>		✓	

Program Number	Program Name/Description	Input Data	Default	Level		
				1	2	3
12-04-01	<b>Holiday Night Service Switching</b> Define a yearly schedule of holiday night-switch settings. This schedule is used for setting special days when the company is expected to be closed, such as national holidays.	Days and Months: 0101 ~ 1231 (e.g. 0101 = Jan. 1; 1231 = Dec. 31) Time Pattern Number: 0 ~ 10 (0 = No Setting)	No Setting		✓	
12-05-01	<b>Night Mode Group Assignment for Extensions</b> Assign Day/Night Mode Group for each extension.	Night Mode Service Group Number: 01 ~ 32	1		✓	
12-06-01	<b>Night Mode Group Assignment for Trunks</b> Assign a Day/Night Mode Group for each trunk port.	Trunk Port Number: 001 ~ 400 Night Mode Service Group Number: 01 ~ 32	1		✓	
12-07-01	<b>Text Data for Night Mode</b> Make up an original text message, which, depending on programming, can be displayed on an LCD of a multiline telephone in each Mode.	Night Mode Service Group Number: 01 ~ 32 Day/Night Mode: 1 ~ 8 Text Message: Maximum 12 Characters (alphabetic or numeric)	Default Text Messages for Day/Night Modes: Mode 1 = No Setting Mode 2 = <Night> Mode 3 = <Midnight> Mode 4 = <Rest> Mode 5 = <Day2> Mode 6 = <Night2> Mode 7 = <Midnight2> Mode 8 = <Rest2>		✓	
12-08-01	<b>Night Mode Service Range</b> Define the changing range of toggle key for each Day/Night Mode.	Night Mode Service Group Number: 01 ~ 32 Range: 2 ~ 8	2		✓	
14-05-01	<b>Trunk Group – Trunk Group Number</b> Program trunks of the same carrier type in the same trunk group.	Trunk Port 1 ~ 400 Group Number 0 ~ 100 Priority 1 ~ 400	Default = Trunks 1 ~ 400 assigned to trunk group 1 with priorities equal to the trunk number. Trunk 1 = Priority 1 Trunk 400 = Priority 400.		✓	

Program Number	Program Name/Description	Input Data	Default	Level		
				1	2	3
14-07-01	<b>Trunk Access Map Setup</b> Set up the Trunk Access Maps. This sets the access options for trunks.	0 = No access 1 = Outgoing access only 2 = Incoming access only 3 = Access only when trunk on Hold 4 = Outgoing access and access when trunk on Hold 5 = Incoming access and access when trunk on Hold 6 = Incoming and Outgoing access 7 = Incoming access, outgoing access and access when trunk on Hold Trunk Access Maps: 1 ~ 400	Access Maps 1 ~ 400 = Trunk Ports 1 ~ 400 assigned with option 7 access (incoming and outgoing access and access when trunk is on Hold).		✓	
15-06-01	<b>Trunk Access Map for Extensions</b> Assign Trunk Access Maps to extensions.	Trunk Access Maps: 1 ~ 400	1		✓	
20-03-04	<b>System Options for Single Line Telephones – Dial Sending Start Time for SLT or ARS</b> When ARS or an analog extension user accesses a trunk and dials an outside call, the system waits this time before outdialing the first digit.	0 ~ 64800 seconds	3		✓	
20-06-01	<b>Class of Service for Extensions</b> Assign a Class of Service (1 ~ 15) to an extension.	Day Night/Mode: 1 ~ 8 Class of Service of Extensions (1 ~ 15)	Extension port 101 = Class 15 All other extension port = Class 1		✓	
20-08-17	<b>Class of Service Options (Outgoing Call Service) – ARS Override of Trunk Access Map</b> Turn Off or On an extension user ability to override the trunk access map programming (Program 14-07-01 and Program 15-06-01) for outgoing calls.	0 = Off 1 = On	COS 1 ~ 15 = 0		✓	
21-02-01	<b>Trunk Group Routing for Extensions</b> Assign Program 14-06 routes to extensions.	Day/Night Mode: 1 ~ 8 Route Table Number: 0 ~ 100 (0 = No Setting)	1		✓	
26-01-01	<b>Automatic Route Selection Service – ARS Service</b> Enable/Disable ARS.	0 = Disabled (ARS service is Off) 1 = Enabled (ARS service is On)	0	✓		

Program Number	Program Name/Description	Input Data	Default	Level		
				1	2	3
26-01-02	<p><b>Automatic Route Selection Service – Network Outgoing Inter-Digit ARS Timer</b></p> <p>With Networking, this timer replaces Program 20-03-04 when determining if all network protocol digits are received. If ARS is enabled at Site B, this timer can be programmed for 5 at Site A. If ARS is disabled and Site B is using F-Route for outbound dialing, this timer should be programmed for 30 at Site A.</p>	0 ~ 64800 seconds	30		✓	
26-01-03	<p><b>Automatic Route Selection Service – ARS Misdialed Number Handling</b></p> <p>If a user dials a number not programmed in ARS, determine if the system should Route over trunk group 1 (0) or Play error tone (1).</p>	0 = Route to Trunk Group 1 1 = Play Warning Tone to Dialer	0		✓	
26-01-06	<p><b>Automatic Route Selection Service – Class of Service Match Access</b></p> <p>With the ARS Class of Service Match Access feature, you can determine whether or not the system should allow a call based on the COS assigned to the Dial Analysis Table (Program 26-02). This change can be used to create a tenant-like application. It then uses the trunk group set in the Additional Entry in Program 26-02-03 to place the out-going call. When this feature is enabled, the calls are routed in sequential order, and forward – provided the Class of Service for the trunk groups match.</p>	0 = Disable (Off) 1 = Enable (On)	0		✓	
26-01-07	<p><b>Automatic Route Selection Service – F-Route Access COS Reference</b></p> <p>Define the system options for Automatic Route Selection (ARS).</p>	0 = F-Route 1 = ARS	0		✓	

Program Number	Program Name/Description	Input Data	Default	Level		
				1	2	3
26-02-01	<p><b>Dial Analysis Table for ARS/LCR – Dial</b>                      Enter the digits (16 digits maximum: 1 ~ 9, 0 * #, @; 2000 separate entries) for the Dial Analysis Table which is analyzed by ARS/LCR. This table is checked after any programmed F-Route operations have completed. The system then refers to Program 26-02-02 and Program 26-02-03 to determine the routing for the call. To enter a wild card/don't care digit, press Line Key 1 to enter an @ symbol. It is important to remember that the system checks the table numbers in numerical order. This means that entries for specific numbers should be entered first (such as your local area codes), then enter the items containing wild card digits. If the system sees an entry of 2@@, any table entries which follow are ignored.</p> <p>For example, if 268, 269, and 270 are local exchanges, these would be the first three table entries which route according to the settings made in Program 26-02-02 and Program 26-02-03 for each of the table entries. If the next entry is 2@@, the system checks no further in this program and routes all other 2xx numbers according to the entries made in Program 26-02-02 and Program 26-02-03 for this table entry.</p>	Dial a maximum of 16 digits (0 ~ 9, * #, @)	No Setting	✓		
26-02-02	<p><b>Dial Analysis Table for ARS – ARS Service Type</b>                      For each Dial Analysis Table (1 ~ 2000), select 0 for no ARS, 1 for Service Type 1 – Route to Trunk Group Number to have the number route to a trunk group [Refer to Program 26-02-03] or 2 for Service Type 2 – F-Route Selected to have the dialed number controlled by the F-Route table. If Service Type 2 is selected and F-Route operation is on, the F-Route table used is determined by Program 44-04. If F-Route operation is off, the routing is determined by Program 44-05.</p>	0 = No Service (Call Restricted) 1 = Route to Trunk Group 2 = Select F-Route Access	0	✓		

Program Number	Program Name/Description	Input Data	Default	Level		
				1	2	3
26-02-03	<p><b>Dial Analysis Table for ARS – Additional Data/Service Number</b></p> <p>For each Dial Analysis Table (1 ~ 2000), if Service Type 1 was selected in Program 26-02-02, enter the trunk group number (0 ~ 100, 0 = No Route)</p>	<p>If Service Type 1 (in 26-02): Select Trunk Group Number 0 ~ 100, (Trunk Group Number 0 = No Route) 101 ~ 150 (Networking ID)</p> <p>If Service Type 2 (in 26-02): F-Route Time Schedule Not Used = 0 ~ 500 (F-Route Table Number). Refer to Programming Manual. F-Route Time Schedule Used = 0 ~ 500 (F-Route Selection Number) Refer to Programming Manual.</p>	0	✓		
26-02-04	<p><b>Dial Analysis Table for ARS – ARS Class of Service</b></p> <p>For each Dial Analysis Table (1 ~ 2000), set the Automatic Route Selection (ARS) (ARS) Class of Service (0 ~ 16).</p>	0 ~ 16	0	✓		
26-02-05	<p><b>Dial Analysis Table for ARS – Dial Treatment for ARS</b></p> <p>For each Dial Analysis Table (1 ~ 2000), set the Automatic Route Selection (ARS) Dial Treatment (0 ~ 15) to be used.</p>	0 ~ 15	0	✓		
26-02-07	<p><b>Dial Analysis Table for ARS – Network Specified Parameter Table</b></p> <p>For each Dial Analysis Table (1 ~ 2000), set the Automatic Route Selection (ARS) (ARS) Network Specified Parameter Table (0 ~ 16) to be used.</p>	0 ~ 16	0	✓		

Program Number	Program Name/Description	Input Data	Default	Level		
				1	2	3
26-03-01	<p><b>ARS Dial Treatments – Treatment Code</b> Assign the Dial Treatments (1 ~ 15) for automatic ARS dialing translation. Assign Dial Treatments to Service Numbers (Trunk Groups) in Program 26-02. The ARS Dial Treatment options are:</p> <p><b>3</b> - Delete the NPA if dialed as part of the initial call. This requires at least eight digits in the ARS table (Program 26-02-01).</p> <p><b>2</b> - Delete the leading digit if dialed as part of the initial call. This requires at least eight digits in the ARS table (Program 26-02-01).</p> <p><b>1</b> - Add a leading 1 if not dialed as part of the initial call. This requires at least eight digits in the ARS table (Program 26-02-01).</p> <p><b>INPA</b> - Insert the NPA specified by NPA.</p> <p><b>DNN</b> - Outdial the NN number of digits or execute the code that follows. For example, D041234 out-dials 124. Valid entries are 0 ~ 9, #, *, Wnn (wait nn seconds) and P (pause). Each digits code counts as a digit. So for example, if a P was added for a pause, the entry would look like: D05P1234. This Dial Treatment can only be added from telephone programming.</p> <p><b>Wnn</b> - Wait nn seconds.</p> <p><b>P</b> - Pause in analog trunk.</p> <p><b>R</b> - Redial the initially dialed number, including any modifications.</p> <p><b>E</b> - End of Dial Treatment. All Dial Treatments must end with the E code.</p> <p><b>X</b> - When ARS is enabled, X must be entered in the Dial Treatment for the system to output the extension number of the call originator to the black box for the E911 feature.</p>	Maximum of 24 characters	No Setting		✓	
26-04-01	<p><b>ARS Class of Service</b> Set an extension ARS Class of Service (0 ~ 16). Automatic Route Selection (ARS) uses ARS Class of Service when determining how to route extension calls.</p>	Day/Night Mode: 1 ~ 8 Class = 0 ~ 16	0		✓	
26-11-01	<p><b>Transit Network ID Table – Transmit Network ID (Carrier ID)</b> Enter the Transit Network Selection information element to be added to an ARS call using an ISDN trunk. This information element identifies a requested transit network.</p>	Four fixed digits 0000 ~ 9999	No Setting		✓	



Program Number	Program Name/Description	Input Data	Default	Level		
				1	2	3
44-01-01	<p><b>System Options for ARS/F-Route – ARS/F-Route Time Schedule</b></p> <p>Select whether the ARS/F-Route feature should use the time schedule (0=not used, 1=used). If this option is set to 0, the F-Route table selected is determined only by the digits dialed without any relation to the day or time of the call. If this option is set to 1, the system first refers to Program 44-10. If there is a match, the pattern defined in that program is used. If not, the F-Route pattern in Program 44-09 and time setting in Program 44-08 are used.</p>	<p>0 = Not Used 1 = Used</p>	0		✓	
44-02-01	<p><b>Dial Analysis Table for ARS/F-Route Access – Dial</b></p> <p>Set the Dial digits for the Pre-Transaction Table for selecting ARS/F-Route (eight digits maximum: 1 ~ 9, 0 * #, @). To enter a wild card/don't care digit, press Line Key 1 to enter an @ symbol.</p>	<p>Maximum of eight digits (Use line key 1 for a 'Don't Care' digit, @)</p>	No Setting		✓	
44-02-02	<p><b>Dial Analysis Table for ARS/F-Route Access – Service Type</b></p> <p>Set the Service Type (0 ~ 3) for the Pre-Transaction Table for selecting ARS/F-Route.</p>	<p>0 = No Setting (None) 1 = Extension Call (Own) 2 = ARS/F-Route Table (F-Route) 3 = Dial Extension Analyze Table (Option)</p>	0		✓	
44-02-03	<p><b>Dial Analysis Table for ARS/F-Route Access – Additional Data</b></p> <p>If a Service Type is set to F-Route in Program 44-02-02, set which F-Route table to use.</p>	<p>1 = Delete Digit = 0 ~ 255 (255: Delete All Digits) 2 = 0 ~ 500 (0 = No Setting) 3 = Dial Extension Analyze Table Number = 0 ~ 4 (0 = No Setting)</p>	0		✓	
44-02-04	<p><b>Dial Analysis Table for ARS/F-Route Access – Dial Tone Simulation</b></p> <p>Determine if the Dial Tone Simulation is On (1) or Off (0) for the Pre-Transaction Table for selecting ARS/F-Route. If enabled, this option sends dial tone to the calling party once the routing is determined. This may be required if the central office at the destination does not send dial tone.</p>	<p>0 = Off 1 = On</p>	0		✓	
44-03-01	<p><b>Dial Analysis Extension Table – Dial</b></p> <p>Set the Dial digits (24 digits maximum: 1 ~ 9, 0 * #, @) to be used for the Dial Extension Analysis Table. When Program 44-02-02 is set to type 3, this program sets the dial extension analysis table. These tables are used when the analyzed digits must be more than eight digits. To enter a wild card/don't care digit, press Line Key 1 to enter an @ symbol.</p>	<p>Maximum of 24 digits Digits = 1 ~ 9, 0, *, #, @ (Press Line Key 1 for wild character @)</p>	No Setting		✓	

Program Number	Program Name/Description	Input Data	Default	Level		
				1	2	3
44-03-02	<b>Dial Analysis Extension Table – ARS/F-Route Select Table Number (1~250)</b> When dialed digits match the setting in Program 44-03-01, select the ARS/R-Route table number (0 ~ 500) to be used for the Dial Extension Analysis Table.	0 ~ 500 (ARS/F-Route Table Number) With Program 44-01 set to 0, Program 44-05 is checked. With Program 44-01 set to 1, Program 44-04 is checked.	0		✓	
44-03-03	<b>Dial Analysis Extension Table – ARS/F-Route Select Table Number (251)</b> If the received digits are not identified in tables 1 ~ 250, the F-Route selection table number (0 ~ 500) defined in table 251 is used.	0 ~ 500 (ARS/F-Route Table Number) With Program 44-01 set to 0, Program 44-05 is checked. With Program 44-01 set to 1, Program 44-04 is checked.	0		✓	
44-03-04	<b>Dial Analysis Extension Table – Next Table Area Number (252)</b> If the received digits do not match the digits set in tables 1 ~ 250, table number 252 is used to refer to the next Extension Table Area (1 ~ 4) to be searched.	0 ~ 4	0		✓	
44-04-01	<b>ARS/F-Route Selection for Time Schedule</b> Assign each ARS/F-Route Selection number (1 ~ 500) to an ARS/F-Route table number for each ARS/F-Route time mode. There are eight time modes for ARS/F-Route Access.	ARS/F-Route Time Mode: 1 ~ 8 ARS/F-Route Table Number = 0 ~ 500	0		✓	
44-05-01	<b>ARS/F-Route Table – Trunk Group Number</b> Select the trunk group number to be used for the outgoing ARS call.	0 = No Setting 1 ~ 100 = Trunk Group from Program 14-05 101 ~ 150 = Networking 255 = Extension Call	0	✓		
44-05-02	<b>ARS/F-Route Table – Delete Digits</b> For each ARS/F-Route table (1 ~ 500) assign a priority number (1 ~ 4). Enter the number of digits to be deleted (0 ~ 255) from the dialed number.	0 ~ 255 (255 = Delete All)	0	✓		
44-05-03	<b>ARS/F-Route Table – Additional Dial Number Table</b> For each ARS/F-Route table (1 ~ 500) assign a priority number (1 ~ 4). Enter the table number (defined in Program 44-06) for additional digits to be dialed (0 ~ 1000).	0 ~ 1000	0	✓		
44-05-04	<b>ARS/F-Route Table – Beep Tone</b> For each ARS/F-Route table (1 ~ 500) assign a priority number (1 ~ 4). Select whether or not a beep is heard if a lower priority trunk group is used.	0 = Off (No Beep) 1 = On (Beep)s	0	✓		

Program Number	Program Name/Description	Input Data	Default	Level		
				1	2	3
44-05-05	<b>ARS/F-Route Table – Gain Table Number for Internal Call</b> For each ARS/F-Route table (1 ~ 500) assign a priority number (1 ~ 4). Select the gain table number to be used for internal calls (0 ~ 500).	0 ~ 500 0 = No Setting	0	✓		
44-05-06	<b>ARS/F-Route Table – Gain Table Number for Tandem Connections</b> For each ARS/F-Route table (1 ~ 500) assign a priority number (1 ~ 4). Select the gain table number to be used for the tandem call (defined in Program 44-07).	0 ~ 500 0 = No Setting	0	✓		
44-05-07	<b>ARS/F-Route Table – ARS Class of Service</b> For each ARS/F-Route table (1 ~ 500) assign a priority number (1 ~ 4). Select the Class of Service to be used for ARS (0~16). Extension ARS COS is determined in Program 26-04-01.	0 ~ 16	0	✓		
44-05-08	<b>ARS/F-Route Table – Dial Treatment</b> For each ARS/F-Route table (1 ~ 500) assign a priority number (1 ~ 4). Select the Dial Treatment to be used (0 ~ 15). The Dial Treatments are defined in Program 26-03-01.	0 ~ 15	0	✓		
44-05-09	<b>ARS/F-Route Table – Maximum Digit</b> Set the maximum number of digits to send when using the F-Route.	0 ~ 24	0	✓		
44-05-10	<b>ARS/F-Route – CCIS over IP Destination Point Code</b> For each ARS/F-Route table (1 ~ 500). Set the CCIS over IP Destination Point Code (0 ~ 16367).	0 ~ 16367	0	✓		
44-05-11	<b>ARS/F-Route – Network Specified Parameter Table</b> For each ARS/F-Route table (1 ~ 500) assign the priority (1 ~ 4). Assign the Network Specified Parameter Table (0 ~ 16).	0 ~ 16	0	✓		
44-06-01	<b>Additional Dial Table</b> If an Additional Dial Number Table is entered in Program 44-05-03, define the additional dial table (1 ~ 1000) to add digits in front of the dialed ARS/F-Route number (24 digits maximum: 1-9, 0 * #, Pause). To enter a wild card/don't care digit, press Line Key 1 to enter a P (pause) symbol.	Maximum of 24 digits Enter: 1 ~ 9, 0, *, #, Pause (press line key 1 to enter a pause)	No Setting		✓	

Program Number	Program Name/Description	Input Data	Default	Level		
				1	2	3
44-07-01	<b>Gain Table for ARS/F-Route Access – Incoming Transmit</b>	Set the gain table to be used (1 ~ 500). If an extension dials ARS/F-Route number: The Extension Dial Gain Table is activated, which is assigned in Program 44-05.	1 ~ 63 (-15.5 ~ +15.5dB) Default = 32 [0dB]		✓	
44-07-02	<b>Gain Table for ARS/F-Route Access – Incoming Receive</b>	The Extension Dial Gain Table follows Outgoing transmit and Outgoing receive settings. If the incoming call is transferred to another line using ARS/F-Route:	1 ~ 63 (-15.5 ~ +15.5dB) Default = 32 [0dB]		✓	
44-07-03	<b>Gain Table for ARS/F-Route Access – Outgoing Transmit</b>	The Tandem Gain Table is activated, which is assigned in Program 44-05. The Tandem Gain Table follows the Incoming transmit and	1 ~ 63 (-15.5 ~ +15.5dB) Default = 32 [0dB]		✓	
44-07-04	<b>Gain Table for ARS/F-Route Access – Outgoing Receive</b>	Incoming receive settings for incoming line, and Outgoing transmit and Outgoing receive settings for the outgoing line. For ARS/F-Route calls, the CODEC gains defined in Program 14-01-02 and Program 14-01-03 are not activated.	1 ~ 63 (-15.5 ~ +15.5dB) Default = 32 [0dB]		✓	
44-08-01	<b>Time Schedule for ARS/F-Route</b> Define the daily pattern of the ARS/F-Route feature. ARS/F-Route has 10 time patterns. These patterns are used in Program 44-09 and Program 44-10. The daily pattern consists of 20 time settings.	Time Number: 01 ~ 20 Start Time = 0000 ~ 2359 End Time = 0000 ~ 2359 Mode: 1 ~ 8	All Schedule Patterns: 0:00 - 0:00, Mode 1		✓	
44-09-01	<b>Weekly Schedule for ARS/F-Route</b> Define a weekly schedule for using ARS/F-Route day numbers 1 ~ 7 (1 = Sun, 7 = Sat), pattern numbers (1 ~ 10). The pattern number is defined in Program 44-08-01.	1 = Sunday (Pattern 1 ~ 10) 2 = Monday (Pattern 1 ~ 10) 3 = Tuesday (Pattern 1 ~ 10) 4 = Wednesday (Pattern 1 ~ 10) 5 = Thursday (Pattern 1 ~ 10) 6 = Friday (Pattern 1 ~ 10) 7 = Saturday (Pattern 1 ~ 10)	Pattern 1		✓	
44-10-01	<b>Holiday Schedule for ARS/F-Route</b> Define a yearly schedule for ARS/F-Route. This schedule is used for setting special days such as national holidays (pattern numbers 1 ~ 10). The pattern number is defined in Program 44-08-01.	Date: 0101 ~ 1231 Schedule Pattern Number = 0 ~ 10 0 = No Setting	0		✓	

Program Number	Program Name/Description	Input Data	Default	Level		
				1	2	3
80-03-01	<b>DTMF Tone Receiver Setup – Detect Level</b> Use Items 11 ~ 32 to set the criteria for dial tone detection for outgoing ARS calls.	0 = 0dBm ~ -25dBm 1 = -5dBm ~ -30dBm 2 = -10dBm ~ -35dBm 3 = -15dBm ~ -40dBm 4 = -20dBm ~ -45dBm 5 = -25dBm ~ -50dBm 6 = -30dBm ~ -55dBm	Type 1 ~ 5 = 0		✓	
80-03-02	<b>DTMF Tone Receiver Setup – Start Delay Time</b> Define the start delay time for DTMF Tone Receiver.	0 ~ 255 (0.25ms ~ 64ms)	Type 1 ~ 5 = 0		✓	
80-03-03	<b>DTMF Tone Receiver Setup – Min. Detect Level</b> Define the minimum detection level for DTMF Tone Receiver.	0 ~ 15 detect level 0: -10dBm(0) to -25dBm(15) detect level 1: -15dBm(0) to -30dBm(15) detect level 2: -20dBm(0) to -35dBm(15) detect level 3: -25dBm(0) to -40dBm(15) detect level 4: -30dBm(0) to -45dBm(15) detect level 5: -35dBm(0) to -50dBm(15) detect level 6: -40dBm(0) to -55dBm(15) detect level 7: -45dBm(0) to -60dBm(15) detect level 8: -50dBm(0) to -65dBm(15) detect level 9: -55dBm(0) to -70dBm(15) detect level 10: -60dBm(0) to -75dBm(15) detect level 11: -65dBm(0) to -80dBm(15) detect level 12: -70dBm(0) to -85dBm(15) detect level 13: -75dBm(0) to -90dBm(15) detect level 14: -80dBm(0) to -95dBm(15) detect level 15: -85dBm(0) to -100dBm(15)	Type 1 = 10 (-20dBm) Type 2 ~ 3 = 15 (-25dBm) Type 4 ~ 5 = 10 (-20dBm)		✓	

Program Number	Program Name/Description	Input Data	Default	Level		
				1	2	3
80-03-04	<b>DTMF Tone Receiver Setup – Max. Detect Level</b> Define the maximum detection level for DTMF Tone Receiver.	0 ~ 15 detect level 0: 0dBm(0) to -15dBm(15) detect level 1: -5dBm(0) to -20dBm(15) detect level 2: -10dBm(0) to -25dBm(15) detect level 3: -15dBm(0) to -30dBm(15) detect level 4: -20dBm(0) to -35dBm(15) detect level 5: -25dBm(0) to -40dBm(15) detect level 6: -30dBm(0) to -45dBm(15) detect level 7: -35dBm(0) to -50dBm(15) detect level 8: -40dBm(0) to -55dBm(15) detect level 9: -45dBm(0) to -60dBm(15) detect level 10: -50dBm(0) to -65dBm(15) detect level 11: -55dBm(0) to -70dBm(15) detect level 12: -60dBm(0) to -75dBm(15) detect level 13: -65dBm(0) to -80dBm(15) detect level 14: -70dBm(0) to -85dBm(15) detect level 15: -75dBm(0) to -90dBm(15)	Type 1 ~ 5 = 2 (-2dBm)		✓	
80-03-05	<b>DTMF Tone Receiver Setup – Forward Twist Level</b> Define the forward twist level for DTMF Tone Receiver.	0 ~ 9 (1dB ~ 10dB)	Type 1 = 5 (6dBm) Type 2 = 5 (6dBm) Type 3 = 5 (6dBm) Type 4 = 5 (6dBm) Type 5 = 5 (6dBm)		✓	

Program Number	Program Name/Description	Input Data	Default	Level		
				1	2	3
80-03-06	<b>DTMF Tone Receiver Setup – Backwards Twist Level</b> Define the backwards twist level for DTMF Tone Receiver.	0 ~ 9 (1dB ~ 10dB)	Type 1 = 0 (1dBm) Type 2 = 0 (1dBm) Type 3 = 0 (1dBm) Type 4 = 0 (1dBm) Type 5 = 0 (1dBm)		✓	
80-03-07	<b>DTMF Tone Receiver Setup – ON Detect Time</b> Define the On detection time for DTMF Tone Receiver.	1 ~ 255 (15+ 15ms ~ 3825ms)	<b>Version 1000</b> Type 1 ~ 5 = 1 (30ms)		✓	
			<b>Version 3000 or higher</b> Type 1 ~ 5 = 3 (60ms)			
80-03-08	<b>DTMF Tone Receiver Setup – OFF Detect Time</b> Define the Off detection time for DTMF Tone Receiver.	1 ~ 255 (15+ 15ms ~ 3825ms)	<b>Version 1000</b> Type 1 ~ 5 = 1 (30ms)		✓	
			<b>Version 3000 or higher</b> Type 1 ~ 5 = 2 (45ms)			

**Recognize Extension Location when Logging In with Netlink:**

Program Number	Program Name/Description	Input Data	Default	Level		
				1	2	3
26-01-01	<b>Automatic Route Selection Service – ARS Service</b> Enable/Disable ARS.	0 = Disable (Off) 1 = Enable (On)	0	✓		
26-01-03	<b>Automatic Route Selection Service – ARS Misdialed Number Handling</b> If a user dials a number not programmed in ARS, determine if the system should Route over trunk group 1 (0) or Play error tone (1).	0 = Route to Trunk Group 1 1 = Play Warning Tone to Dialer	0		✓	

Program Number	Program Name/Description	Input Data	Default	Level		
				1	2	3
26-01-06	<p><b>Automatic Route Selection Service – Class of Service Match Access</b></p> <p>With the ARS Class of Service Match Access feature, you can determine whether or not the system should allow a call based on the COS assigned to the Dial Analysis Table (Program 26-02). This change can be used to create a tenant-like application. It then uses the trunk group set in the Additional Entry in Program 26-02-03 to place the out-going call. When this feature is enabled, the calls are routed in sequential order, and forward – provided the Class of Service for the trunk groups match.</p>	<p>0 = Disable (Off)</p> <p>1 = Enable (On)</p>	0	✓		
26-01-08	<p><b>Automatic Route Selection Service – DT800/DT700 Multi Log-on for ARS</b></p> <p>Enable or Disable Recognize Extension Location when logging in with NetLink</p>	<p>0 = Disable (Off)</p> <p>1 = Enable (On)</p>	0	✓		
26-02-01	<p><b>Dial Analysis Table for ARS/LCR – Dial</b></p> <p>Enter the digits (16 digits maximum: 1 ~ 9, 0 * #, @; 2000 separate entries) for the Dial Analysis Table which is analyzed by ARS/LCR. This table is checked after any programmed F-Route operations have completed. The system then refers to Program 26-02-02 and Program 26-02-03 to determine the routing for the call. To enter a wild card/don't care digit, press Line Key 1 to enter an @ symbol. It is important to remember that the system checks the table numbers in numerical order. This means that entries for specific numbers should be entered first (such as your local area codes), then enter the items containing wild card digits. If the system sees an entry of 2@@, any table entries which follow are ignored.</p> <p>For example, if 268, 269, and 270 are local exchanges, these would be the first three table entries which route according to the settings made in Program 26-02-02 and Program 26-02-03 for each of the table entries. If the next entry is 2@@, the system checks no further in this program and routes all other 2xx numbers according to the entries made in Program 26-02-02 and Program 26-02-03 for this table entry.</p>	<p>Maximum of 16 digits (0 ~ 9, * #, @)</p>	No Setting	✓		



Program Number	Program Name/Description	Input Data	Default	Level		
				1	2	3
26-02-02	<p><b>Dial Analysis Table for ARS – ARS Service Type</b></p> <p>For each Dial Analysis Table (1 ~ 2000), select 0 for no ARS, 1 for Service Type 1 – Route to Trunk Group Number to have the number route to a trunk group [Refer to Program 26-02-03] or 2 for Service Type 2 – F-Route Selected to have the dialed number controlled by the F-Route table. If Service Type 2 is selected and F-Route operation is on, the F-Route table used is determined by Program 44-04. If F-Route operation is off, the routing is determined by Program 44-05.</p>	<p>0 = No Service (Call Restricted)                      1 = Route to Trunk Group                      2 = Select F-Route Access</p>	0	✓		
26-02-03	<p><b>Dial Analysis Table for ARS – Additional Data/Service Number</b></p> <p>For each Dial Analysis Table (1 ~ 2000), if Service Type 1 was selected in Program 26-02-02, enter the trunk group number (0 ~ 100, 0 = No Route).</p>	<p>If Service Type 1 (in 26-02):                      Select Trunk Group Number                      0 ~ 100, (Trunk Group Number 0 = No Route)                      101 ~ 150 (Networking ID)                      If Service Type 2 (in 26-02):                      F-Route Time Schedule Not Used = 0 ~ 500                      (F-Route Table Number).                      Refer to Programming Manual.                      F-Route Time Schedule Used = 0 ~ 500                      (F-Route Selection Number)</p>	0	✓		
26-02-04	<p><b>Dial Analysis Table for ARS – ARS Class of Service</b></p> <p>For each Dial Analysis Table (1 ~ 2000), set the Automatic Route Selection (ARS) (ARS) Class of Service (0 ~ 16).</p>	0 ~ 16	0	✓		
26-02-05	<p><b>Dial Analysis Table for ARS – Dial Treatment for ARS</b></p> <p>For each Dial Analysis Table (1 ~ 2000), set the Automatic Route Selection (ARS) Dial Treatment (0 ~ 15) to be used.</p>	0 ~ 15	0	✓		
26-02-07	<p><b>Dial Analysis Table for ARS – Network Specified Parameter Table</b></p> <p>For each Dial Analysis Table (1 ~ 2000), set the Automatic Route Selection (ARS) (ARS) Network Specified Parameter Table (0 ~ 16) to be used.</p>	0 ~ 16	0	✓		

Program Number	Program Name/Description	Input Data	Default	Level		
				1	2	3
26-03-01	<p><b>ARS Dial Treatments – Treatment Code</b> Assign the Dial Treatments (1 ~ 15) for automatic ARS dialing translation. Assign Dial Treatments to Service Numbers (Trunk Groups) in Program 26-02. The ARS Dial Treatment options are:</p> <p><b>3</b> - Delete the NPA if dialed as part of the initial call. This requires at least eight digits in the ARS table (Program 26-02-01).</p> <p><b>2</b> - Delete the leading digit if dialed as part of the initial call. This requires at least eight digits in the ARS table (Program 26-02-01).</p> <p><b>1</b> - Add a leading 1 if not dialed as part of the initial call. This requires at least eight digits in the ARS table (Program 26-02-01).</p> <p><b>INPA</b> - Insert the NPA specified by NPA.</p> <p><b>DNN</b> - Outdial the NN number of digits or execute the code that follows. For example, D041234 out-dials 124. Valid entries are 0 ~ 9, #, *, Wnn (wait nn seconds) and P (pause). Each digits code counts as a digit. So for example, if a P was added for a pause, the entry would look like: D05P1234. This Dial Treatment can only be added from telephone programming.</p> <p><b>Wnn</b> - Wait nn seconds.</p> <p><b>P</b> - Pause in analog trunk.</p> <p><b>R</b> - Redial the initially dialed number, including any modifications.</p> <p><b>E</b> - End of Dial Treatment. All Dial Treatments must end with the E code.</p> <p><b>X</b> - When ARS is enabled, X must be entered in the Dial Treatment for the system to output the extension number of the call originator to the black box for the E911 feature.</p>	Maximum of 24 characters	No Setting		✓	
26-04-01	<p><b>ARS Class of Service</b> Set an extension ARS Class of Service (0 ~ 16). Automatic Route Selection (ARS) uses ARS Class of Service when determining how to route extension calls.</p>	Day/Night Mode: 1 ~ 8 Class = 0 ~ 16	0		✓	
26-13-01	<p><b>ARS Class of Service for NetLink (DT800/DT700)</b> Use to set an extension’s ARS Class of Service when used for NetLink. Automatic Route Selection uses ARS Class of Service when determining how to route an extension’s calls.</p>	Day/Night Mode: 1 ~ 8 Class = 0 ~ 16	0	✓		
44-05-01	<p><b>ARS/F-Route Table – Trunk Group Number</b> Select the trunk group number to be used for the outgoing ARS call.</p>	0 = No Setting 1 ~ 100 = Trunk Group from Program 14-05 101 ~ 150 = Networking 255 = Extension Call	0	✓		

Program Number	Program Name/Description	Input Data	Default	Level		
				1	2	3
44-05-02	<b>ARS/F-Route Table – Delete Digits</b> For each ARS/F-Route table (1 ~ 500) assign a priority number (1 ~ 4). Enter the number of digits to be deleted (0 ~ 255) from the dialed number.	0 ~ 255 (255 = Delete All)	0	✓		
44-05-03	<b>ARS/F-Route Table – Additional Dial Number Table</b> For each ARS/F-Route table (1 ~ 500) assign a priority number (1 ~ 4). Enter the table number (defined in Program 44-06) for additional digits to be dialed (0 ~ 1000).	0 ~ 1000	0	✓		
44-05-04	<b>ARS/F-Route Table – Beep Tone</b> For each ARS/F-Route table (1 ~ 500) assign a priority number (1 ~ 4). Select whether or not a beep is heard if a lower priority trunk group is used.	0 = Off (No Beep) 1 = On (Beep)s	0	✓		
44-05-05	<b>ARS/F-Route Table – Gain Table Number for Internal Call</b> For each ARS/F-Route table (1 ~ 500) assign a priority number (1 ~ 4). Select the gain table number to be used for internal calls (0 ~ 500).	0 ~ 500 0 = No Setting	0	✓		
44-05-06	<b>ARS/F-Route Table – Gain Table Number for Tandem Connections</b> For each ARS/F-Route table (1 ~ 500) assign a priority number (1 ~ 4). Select the gain table number to be used for the tandem call (defined in Program 44-07)	0 ~ 500 0 = No Setting	0	✓		
44-05-07	<b>ARS/F-Route Table – ARS Class of Service</b> For each ARS/F-Route table (1 ~ 500) assign a priority number (1 ~ 4). Select the Class of Service to be used for ARS (0 ~ 16). Extension ARS COS is determined in Program 26-04-01.	0 ~ 16	0	✓		
44-05-08	<b>ARS/F-Route Table – Dial Treatment</b> For each ARS/F-Route table (1 ~ 500) assign a priority number (1 ~ 4). Select the Dial Treatment to be used (0 ~ 15). The Dial Treatments are defined in Program 26-03-01.	0 ~ 15	0	✓		
44-05-09	<b>ARS/F-Route Table – Maximum Digit</b> Set the maximum number of digits to send when using the F-Route.	0 ~ 24	0	✓		
44-05-10	<b>ARS/F-Route – CCIS over IP Destination Point Code</b> For each ARS/F-Route table (1 ~ 500). Set the CCIS over IP Destination Point Code (0 ~ 16367).	0 ~ 16367	0	✓		

Program Number	Program Name/Description	Input Data	Default	Level		
				1	2	3
44-05-11	<b>ARS/F-Route – Network Specified Parameter Table</b> For each ARS/F-Route table (1 ~ 500) assign the priority (1 ~ 4). Assign the Network Specified Parameter Table (0 ~ 16).	0 ~ 16	0	✓		
51-01-01	<b>NetLink System Property Setting – NetLink System ID</b> This is the ID of each NetLink system. Set to insure that no overlap occurs between nodes.	0 ~ 50 (0 = No operation)	0	✓		
51-03-01	<b>NetLink Internet Protocol Address List Setting – Internet Protocol Address List</b> The system seeks the Primary system based on this list. When there is no Primary system yet, or Fail Over occurs, Node List is referred to establish new link. This setting is necessary when Program 51-01-03 is 0, or Program 51-05-02 is other than 0. Once the system connects to the Primary System, this setting is updated by the Primary system when Program 51-13-01 is On. So, enter IP address of the systems which may become Primary at least.	0.0.0.0 ~ 126.255.255.254 128.0.0.1 ~ 191.255.255.254 192.0.0.1 ~ 223.255.255.254	0.0.0.0	✓		

## Operation

### To place a call using ARS:

1. At the multiline terminal, press **Speaker**.  
- OR -  
At the single line telephone, lift the handset.  
◇ *You hear normal Intercom dial tone.*
2. Dial **9**.  
◇ *You hear a second, “stutter” dial tone.*
3. Dial the outside number.  
◇ *If you hear another “stutter” dial tone, you must enter your extension ARS Authorization Code.*

### Description

Background Music (BGM) sends music from a customer-provided music source to the speakers of the multiline telephone when the station is idle.

#### Conditions

- An ACI [PGD(2)-U10 ADP] port must be used as an alternate External Music on Hold or Background Music source when different External MOH and BGM sources are required.
- Background Music stops while the multiline terminal is in use.
- Originating a call, answering a voice announcement, a ringing call, or internal paging interrupts Background Music.
- Background Music is not available on single line telephones.

#### Default Settings

Background Music (BGM) is not allowed, a service code to enable/disable Background Music must be assigned in Program 11-11-18.

### System Availability

#### Terminals

All Multiline Terminals

#### Required Component(s)

- Locally provided Background Music source (i.e., CD player, Radio, NEC Audio Emcee).
- PGD(2)-U10 ADP if different external MOH and BGM sources are required.

### Related Features

↳ **Music on Hold**

## Guide to Feature Programming

The **Level 1**, **Level 2** and **Level 3** columns indicate the programs that are assigned when programming this feature in the order they are most commonly used. These levels are used with PCPro and WebPro wizards for feature programming.

- Level 1 – these are the most commonly assigned programs for this feature.
- Level 2 – these are the next most commonly assigned programs for this feature.
- Level 3 – these programs are not often assigned and require an expert level working knowledge of the system to be properly assigned.

Program Number	Program Name/Description	Input Data	Default	Level		
				1	2	3
10-24-01	<b>Daylight Savings Setup – Daylight Savings Mode</b> Enable/Disable the system ability to adjust the time for daylight savings/standard time.	0 = Disable 1 = Enable	1	✓		
10-38-01	<b>BGM Resource Setup – BGM Resource Type</b> Configure the Background Music Source input (0) for GCD-CP10 or (1) for ACI Port.	0 = GCD-CP10 (MOH/IN) 1 = ACI Port	0	✓		
10-38-02	<b>BGM Resource Setup – ACI Port Number for BGM Source (only used if Program 10-38-01 is set to 1)</b> Program the ACI Port to be used for BGM (0 ~ 96).	0 ~ 96	0	✓		
11-11-18	<b>Service Code Setup (for Setup/Entry Operation) – BGM On/Off</b> Assign the Service Code to Enable/Disable BGM.	MLT	No Setting	✓		
20-06-01	<b>Class of Service for Extensions</b> Assign a Class of Service (1 ~ 15) to an extension.	Day Night/Mode: 1 ~ 8 Class of Service of Extensions (1 ~ 15)	Extension port 101 = Class 15 All other extension port = Class 1	✓		
20-13-30	<b>Class of Service Options (Supplementary Service) – Background Music</b> Allow/Deny an extension to turn Background Music on and off.	0 = Deny 1 = Allow	COS 1 ~ 15 = 1	✓		

## Operation

### To turn Background Music on or off:

1. Press idle **Speaker**.
2. Dial **725** (Service Code assigned in Program 11-11-18).
3. Press **Speaker** to hang up.

## Barge-In

### Description

Barge-In permits an extension user to break into another extension user's established call, including Conference calls. This sets up a Conference-type conversation between the intruding extension and the parties on the initial call. With Barge-In, an extension user can get a message through to a busy co-worker right away.

There are two Barge-In modes: Monitor Mode (Silent Monitor) and Speech Mode. With Monitor Mode, the caller Barging In can listen to another user's conversation but cannot participate. With Speech Mode, the caller Barging In can listen and join another user's conversation.



CAUTION

*The use of monitoring, recording, or listening devices to eavesdrop, monitor, retrieve, or record telephone conversation or other sound activities, whether or not contemporaneous with transmission, may be illegal in certain circumstances under federal or state laws. Legal advice should be sought prior to implementing any practice that monitors or records any telephone conversation. Some federal and state laws require some form of notification to all parties to a telephone conversation, such as using a beep tone or other notification methods or requiring the consent of all parties to the telephone conversation, prior to monitoring or recording the telephone conversation. Some of these laws incorporate strict penalties.*

### Conditions

- An extension user can barge-in on a conference.
- An extension user cannot barge-in on an Intercom call if one of the intercom callers is using Handsfree Answerback. Both Intercom parties must lift the handset or press Speaker.
- With Program 20-13-10 set to 0, a barged into call can be placed on hold by the originator of the outside call. Both the outside caller and the extension that barged into the call are placed on hold.
- With Program 20-13-10 set to 1, a call which is barged into can be placed on Park by the originator of the outside call, but only the outside caller is placed in Park. The extension which barged into the call is dropped.
- When Program 20-13-10 is set to 1 (Monitor), only one party can barge into the call.
- Privacy blocks Barge-In attempts.
- Function keys simplify the Barge-In operation.
- When Silent Monitor Mode is used, MIC or Feature + 1 can be used to activate speech path to the internal and external parties.

- The Barge-In key allows for additional data to be assigned to the key. The additional data can be set to:
  - Nothing (same as before).
  - Extension Number (when pressed it will Barge-In to that Extension).
  - The \* (when pressed) barges into the Extension where Call Forward Both Ring is set. If no Forward Both Ring is set, it will act as though no additional data is set [Basic Barge-In Functionality].
- When using Barge-In, the maximum number of conference ports supported is 32 (two original participants and a maximum of 30 Barge-In participants).
- Live Record is not supported on Monitored calls, Conference calls or Internal calls.
- Handset Mute cannot be enabled on a handset if the extension is being silent monitored.
- If Handset Mute is enabled on the handset and the extension is set to silent monitor, the handset is immediately un-muted.

### Default Settings

Disabled

## System Availability

### Terminals

All Terminals

### Required Component(s)

None

## Related Features

- ↳ **Call Monitoring**
- ↳ **Conference**
- ↳ **Hold**
- ↳ **Intercom**
- ↳ **Off-Hook Signaling**
- ↳ **Park**
- ↳ **Programmable Function Keys**



## Guide to Feature Programming

The **Level 1**, **Level 2** and **Level 3** columns indicate the programs that are assigned when programming this feature in the order they are most commonly used. These levels are used with PCPro and WebPro wizards for feature programming.

- Level 1 – these are the most commonly assigned programs for this feature.
- Level 2 – these are the next most commonly assigned programs for this feature.
- Level 3 – these programs are not often assigned and require an expert level working knowledge of the system to be properly assigned.

Program Number	Program Name/Description	Input Data	Default	Level		
				1	2	3
11-12-08	<b>Service Code Setup (for Service Access) – Barge-In</b> Determine what the service code should be for an internal party to use the Barge-In feature.	MLT, SLT Maximum of eight digits 0 ~ 9, *, #	710		✓	
11-16-02	<b>Single Digit Service Code Setup – Barge-In</b>	Set up Item 02 for single digit Barge-In. For example, you can assign Item 02 to use digit 5 for Barge-In. This allows you to program a function key with an extension number plus the Barge-In code (i.e., 5). This allows one-touch access to the Barge-In feature for extension.	No Setting	✓		
15-07-01	<b>Programmable Function Keys</b> Assign a function key for Barge-In (code 34). Optional additional data can be assigned as extension number or *.	Line Key 1 ~ 48 0 ~ 99 (Normal Function Code 751 by default) *00 ~ *99 (Appearance Function Code) (Service Code 752 by default)	Refer to the Programming Manual for default values.	✓		
20-06-01	<b>Class of Service for Extensions</b> Assign a Class of Service (1 ~ 15) to an extension.	Day Night/Mode: 1 ~ 8 Class of Service of Extensions (1 ~ 15)	Extension port 101 = Class 15 All other extension port = Class 1	✓		
20-13-10	<b>Class of Service Options (Supplementary Service) – Barge-In Monitor</b> Enable the extension Barge-In Mode to be Speech mode or Monitor mode.	0 = Speech 1 = Monitor	COS 1 ~ 15 = 0		✓	
20-13-15	<b>Class of Service Options (Supplementary Service) – Barge-In, Initiate</b> Turn Off or On an extension user ability to barge-in on other's calls.	0 = Off 1 = On	COS 1 ~ 15 = 0	✓		
20-13-16	<b>Class of Service Options (Supplementary Service) – Barge-In, Receive</b> Turn Off or On Barge-In at the receiving extension (i.e., Barge-In receive).	0 = Off 1 = On	COS 1 ~ 15 = 0	✓		

Program Number	Program Name/Description	Input Data	Default	Level		
				1	2	3
20-13-17	<b>Class of Service Options (Supplementary Service) – Barge-In Tone/Display (Intrusion Tone)</b> Turn Off or On the Barge-In (Intrusion) Tone. If disabled, this also turns off the Barge-In display at the called extension.	0 = Off 1 = On	COS 1 ~ 15 = 1		✓	
20-13-32	<b>Class of Service Options (Supplementary Service) – Deny Multiple Barge-Ins</b> Allow (1)/Deny (0) an extension user ability to have multiple users Barge-In to their conversation.	0 = Off 1 = On	COS 1 ~ 15 = 0		✓	
20-14-11	<b>Class of Service Options for DISA/E&amp;M – DISA/Tie Trunk Barge-In</b> Enable (1)/Disable (0) a DISA or tie trunk user from using the Barge-In feature.	0 = Off 1 = On	COS 1 ~ 15 = 0		✓	
20-18-07	<b>Service Tone Timers – Intrusion Tone Repeat Time</b> After a user barges in, the system repeats the Barge-In tone after this time.	0 ~ 64800 seconds	0			✓
21-01-03	<b>System Options for Outgoing Calls – Trunk Interdigit Time (External)</b> Program the time an extension must wait before using the Barge-In feature can be used on a call (this timer waits until it expires before putting a call in a talk state). This time also affects Voice Over.	0 ~ 64800 seconds	5			✓

## Operation

### To Barge-In after calling a busy extension:



*The time in Program 21-01-03 must expire before you can Barge-In.*

1. Call a busy extension.
2. Press Barge-In key (Program 15-07-01 or SC 751: 34).

### To Barge-In without first calling the busy extension:

1. Pick up the handset or press **Speaker**.
  2. Dial **710**.
- OR -
- Press Barge-In key (Program 15-07-01 or SC 751: 34).

3. Dial busy extension.
  - ◇ *The extension user hears a warning tone.*
  - ◇ *The DISA user is rerouted to the defined ring group.*
  - ◇ *The Tie Line user hears a busy tone.*

- OR -

The following steps are not available for DISA or Tie Line trunks:

1. Dial the extension number of the busy internal party.
2. Dial the single digit service code or the service code **710**.

#### To Barge-In to a Conference Call:

1. Pick up the handset or press **Speaker** and dial the service code (default = **710**).
  - ◇ *If the telephone does not have the proper COS, a warning tone is sent. After the user hangs up, the system automatically places a callback to the extension.*
2. Dial the extension number or press a DSS key of a telephone in a conference call.

When a new call is added to the conference, an intrusion tone is heard by all parties in the Conference, depending on system programming, and all display multiline terminals show the joined party. If a Conference is not possible:

  - ◇ *The extension user hears a warning tone.*
  - ◇ *The DISA user is rerouted to the defined ring group.*
  - ◇ *The Tie Line user hears a busy tone.*

**Not available for DISA or Tie Line trunks.**

- OR -

1. Dial the extension number of the internal party.
2. Dial the single digit service code or the service code **710**.

## Battery Backup - System Memory

### Description

The battery on the GCD-CP10 retains the Clock/Calendar and Last Number Redial (LNR) buffers for each station when the GCD-CP10 encounters a power loss. With a fully charged battery, the settings are retained for approximately three years.

The system programmed memory (Customer Database) is stored in Nonvolatile Memory and can be erased only by performing a First Initialization.



TIP

*For additional storage time, the database and Caller ID History can be copied to the system drive on the GCD-CP10.*

### Conditions

- The battery on the GCD-CP10 should be removed during long term storage but must be installed (protection against loss of power) just before blade installation to provide battery backup for System Memory.
- When fully charged, the battery retains System Memory for approximately three years.
- You should replace the GCD-CP10 battery every three years.
- During normal operation, the battery is continually recharged using a built-in charging circuit from the GCD-CP10.
- To prevent loss of the Caller ID History, you should save the database before storing the GCD-CP10.
- Battery backup on the GCD-CP10 does not protect the following:
  - Callback
  - Off-line Status (for programming system or station assignments)
  - Repeat Redial
  - Trunk Queuing/Camp-On
  - Caller ID History

### Default Settings

None

- ◇ *The battery must be installed on the GCD-CP10 prior to programming a customer database.*

## System Availability

### Terminals

None

### Required Component(s)

None

## Related Features

↳ **Battery Backup - System Power**

## Guide to Feature Programming

The **Level 1**, **Level 2** and **Level 3** columns indicate the programs that are assigned when programming this feature in the order they are most commonly used. These levels are used with PCPro and WebPro wizards for feature programming.

- Level 1 – these are the most commonly assigned programs for this feature.
- Level 2 – these are the next most commonly assigned programs for this feature.
- Level 3 – these programs are not often assigned and require an expert level working knowledge of the system to be properly assigned.

Program Number	Program Name/Description	Input Data	Default	Level		
				1	2	3
<b>90-03-01</b>	<p><b>Save Data</b></p> <p>Save the programmed data on the SRAM and Flash ROM to the 16MB/32MB ATA removable Compact Flash memory card. This program should be used after changing the programmed data.</p> <p>↳ <i>This program is available only via telephone programming and not through PC Programming.</i></p>	Dial 1 + Press <b>Hold</b>	No Setting	✓		

## Operation

None

## Battery Backup - System Power

### Description

A built-in battery provides complete system operating power for approximately 30 minutes during commercial power outages. When optional (locally provided) batteries are connected and fully charged, full system operation can be maintained for an extended time. Actual time depends on system configuration, traffic conditions, and the capacity of the batteries.

### Conditions

- During normal operation, the batteries are continually recharged by a built-in charging circuit.
- The GCD-CP10 is equipped with batteries for system battery backup.
- An External Battery Pack can be connected to the system to provide extended time during a commercial power outage.



*Refer to the UNIVERGE SV9100 System Hardware Manual for additional details.*

### Default Settings

None

### System Availability

#### Terminals

None

#### Required Component(s)

GCD-CP10

### Related Features

➔ **Battery Backup - System Memory**

Programming

None

Operation

None





### Description

When an extension user calls a co-worker that does not answer or is busy, they can leave a Callback request for a return call. The user does not have to repeatedly call the unanswered extension back, hoping to find it idle.

The system processes Callback requests as follows:

1. Caller at extension A leaves a Callback at extension B.
  - ◇ *Caller can place or answer additional calls in the meantime.*
2. When extension B becomes idle, the system rings extension A. This is the Callback ring.
3. Once caller A answers the Callback ring, the system rings (formerly busy or unanswered) extension B.
  - ◇ *If caller A does not answer the Callback ring, the system cancels the Callback.*
4. As soon as caller B answers, the system sets up an Intercom call between A and B.

Callback Automatic Answer determines how an extension user answers the Callback ring. When Callback Automatic Answer is enabled, a user answers the Callback ring when they lift the handset. When Callback Automatic Answer is disabled, the user must press the ringing line appearance to answer the Callback ring.

### Conditions

- An extension can leave only one Callback request at a time.
- Call Arrival (CAR) Key (virtual extension) keys do not support Call Waiting/ Camp-On Programmable Function keys (code 35).
- If an extension user initiates a Callback but does not hang up, their extension Camps-On to the busy extension.
- Function Keys simplify Callback operation.
- The Callback feature is not available when calling a busy station from a Wireless DECT (SIP) handset.

### Default Settings

Enabled

## System Availability

### Terminals

All Terminals

### Required Component(s)

None

## Related Features

- [Call Waiting/Camp-On](#)
- [Programmable Function Keys](#)

## Guide to Feature Programming

The **Level 1**, **Level 2** and **Level 3** columns indicate the programs that are assigned when programming this feature in the order they are most commonly used. These levels are used with PCPro and WebPro wizards for feature programming.

- Level 1 – these are the most commonly assigned programs for this feature.
- Level 2 – these are the next most commonly assigned programs for this feature.
- Level 3 – these programs are not often assigned and require an expert level working knowledge of the system to be properly assigned.

Program Number	Program Name/Description	Input Data	Default	Level		
				1	2	3
11-12-05	<b>Service Code Setup (for Service Access) – Cancel Camp-On</b> If required, redefine the service code used cancel Camp-On.	MLT, SLT 0 ~ 9, *, # Maximum of eight digits	770		✓	
11-12-44	<b>Service Code Setup (for Service Access) – Callback Test for SLT</b> If required, redefine the service code used for SLT Callback Test.	SLT 0 ~ 9, *, # Maximum of eight digits	799		✓	
11-16-05	<b>Single Digit Service Code Setup – Camp-On</b> If required, redefine the service code used to set Camp-On.	0 ~ 9, *, # Maximum of one digit	#		✓	
15-02-11	<b>Multiline Telephone Basic Data Setup – Callback Automatic Answer</b> Enable (1)/ Disable (0) Callback Automatic Answer.	0 = Off 1 = On	1		✓	

Program Number	Program Name/Description	Input Data	Default	Level		
				1	2	3
15-07-01	<b>Programmable Function Keys</b> Assign functions to multiline terminal line keys.	Line Key 1 ~ 48 0 ~ 99 (Normal Function Code 751 by default) *00 ~ *99 (Appearance Function Code) (Service Code 752 by default)	Refer to the Programming Manual for default values.	✓		
20-01-07	<b>System Options – Callback Ring Duration Time</b> Set the time of the Callback ring.	0 ~ 64800 seconds	15		✓	
20-01-09	<b>System Options – Callback/Trunk Queuing Cancel Time</b> The system cancels Callback and Trunk Queuing requests after this time.	0 ~ 64800 seconds	64800		✓	

## Operation

### To place a Callback:

1. Call unavailable (busy or unanswered) extension.
2. Dial # or press the Callback key (Program 15-07 or SC 751: 35).
3. Hang up.
4. Lift the handset when busy extension calls you back.
  - ◇ *If the unavailable extension was unanswered (not busy), the Callback goes through after your co-worker uses their telephone for the first time.*
  - ◇ *If you have Callback Automatic Answer, you automatically place a call to the formerly busy extension when you lift the handset. If you do not have Callback Automatic Answer, you must press the ringing line appearance to place the call.*

### To cancel a Callback:

1. At the multiline terminal, press **Speaker** and Dial **770**.  
- OR -  
At the multiline terminal, press Camp-On key (Program 15-07 or SC 751: 35).  
- OR -  
At the single line telephone, lift the handset and dial **770**.

**To test Callback at a single line telephone:**

1. Lift the handset.
2. Dial **799**.
3. Hang up.
4. When the telephone rings, lift the handset.
  - ◇ *You hear the Hold tone.*
5. Hang up.

## Caller ID Call Return

### Description

The Caller ID Call Return feature allows the voice mail system to use Caller ID information captured with the message to call and connect the person that left the message with the voice mail user that is checking messages.

### Conditions

- A caller using a telephone without Softkeys, calling from outside the system, or from a remote system is prompted to hear Caller ID information and return a call.
- Return Call is available for subscriber messages and public messages.
- Return Call is accessible to a subscriber during and after message playback.
- Return Call is available for new and old messages.
- Return Call is accessible to a subscriber using Softkeys in Softkey mode or using DTMF in voice conversation Mode.
- On the UM8000 Mail, one minute before disconnecting the original caller, voice mail plays a warning prompt and immediately before disconnecting plays a prompt to indicate dropping the call.
- When a subscriber listens to a message from a Softkey equipped telephone, and Caller ID information is unavailable, the voice mail system leaves the second line of the LCD blank. When Caller ID is disabled on the system, voice mail displays the message count.
- On the UM8000 Mail, from the subscriber options Softkey menu, a subscriber can access a Softkey menu that allows selection of name or number to be displayed on the LCD during message playback. The default is name. Voice mail uses this setting to determine the initial display on the LCD during playback.
- Voice mail continues to display Caller ID on the LCD while the post-message playback menu is still displayed on a telephone equipped with Softkeys.
- On the UM8000 Mail, during return call, the voice mail port is in conference with the box owner and messages.
- When Centralized Voice Mail is used, the remote voice mail user gets only Caller ID number when voice mail answers incoming CO calls and performs an Await-Answer transfer to the remote user. A Call that forwards to voice mail from the remote system does not have Caller ID information.
- Live Record is not available when using Return Call.
- A Telephone used as a Contact Center Plus agent or supervisor station should not have mailboxes that support Softkeys. Softkeys can be disabled per mailbox in Access Codes Options by enabling Hands Free Play for a particular station.

- On the UM8000 Mail, the Return Call feature is enabled per mailbox in Subscriber/Access Options and can be enabled for internal numbers only or for both internal and external numbers.
- To use this feature for long distance calls, ARS must be programmed for the voice mail ports set to dial out.



— *Refer to the UNIVERGE SV9100 Programming Manual for detailed programming instructions.*

- On the UM8000 Mail, the Return Call parameter must be entered on the Integration Options line of System/Switch/Switch Information Screen to enable this voice mail feature. Default is RCV=6,10 where 6 is the number of rings voice mail tries when returning a call, and 10 is the number of minutes a returned call can last.
- On the UM8000 Mail, a trunk access code must be entered on the Return call outdial access code line of System/Switch/Dialing Codes screen so the Return Call feature can access a trunk to return the call. When this is not entered, the mailbox user is not prompted to return the call even when Caller ID information is available.
- Use Program 14-01-22 Caller ID to Voice Mail to enable or disable per trunk the ability to send the Caller ID digits to voice mail.
- After the call is ended by either party, the voice mail user is disconnected.

## Default Settings

None

## System Availability

### Terminals

All Multiline Terminals

### Required Component(s)

- UM8000 Mail
- InMail

## Related Features

➔ **UM8000 Mail**

➔ **InMail**

## Guide to Feature Programming

The **Level 1**, **Level 2** and **Level 3** columns indicate the programs that are assigned when programming this feature in the order they are most commonly used. These levels are used with PCPro and WebPro wizards for feature programming.

- Level 1 – these are the most commonly assigned programs for this feature.
- Level 2 – these are the next most commonly assigned programs for this feature.
- Level 3 – these programs are not often assigned and require an expert level working knowledge of the system to be properly assigned.

Program Number	Program Name/Description	Input Data	Default	Level		
				1	2	3
14-01-22	<b>Basic Trunk Data Setup – Caller ID to Voice Mail</b> Enable/Disable the system ability to send the Caller ID digits to voice mail.	Trunks 1 ~ 400 0 = Disable 1 = Enable	0	✓		
14-02-10	<b>Analog Trunk Data Setup – Caller ID</b> Enable (1)/Disable (0) a trunk to receive Caller ID information.	Trunks 1 ~ 400 0 = Off (Caller ID not displayed.) 1 = On (Caller ID is displayed.)	0	✓		
15-02-04	<b>Multiline Telephone Basic Data Setup – Redial (Speed Dial) Control</b> Control the function of the extension Redial key when used with Speed Dialing. The Redial key can access either the Common or Group Speed Dialing numbers.	0 = Common Abbreviated Dial 1 = Group Speed Dialing	0	✓		

## Operation

### To return call from the UM8000 Mail:

1. While listening to a message with CID information press **More, More** then **Call** softkeys.  
- OR -  
Dial #, **0**.
2. To exit from the call, hang up.

**To return call from InMail:**

1. While listening to a message with CID information press **More, More** then **Call** softkeys.  
- OR -  
Dial **6, 2 (MC)**.
2. To exit from the call, hang up.
  - ◇ *If you hear “Your call cannot go through,” your system Caller ID is not properly set up. You will be returned to the listen mode for the message you were listening to when you tried the Make Call.*



## Caller ID

### Description

Caller ID allows a display terminal to show an incoming caller's telephone number (called the Directory Number or DN) and optional name. The Caller ID information is available as pre-answer display. With the pre-answer display, the user previews the caller's number before picking up the ringing line.



NOTE

*On the GCD-CP10 for Caller ID (also used for DTMF receivers and Call Progress Tone Detection) 32 resources are available. The GPZ-BS10 provides an additional 64 resources.*

### Second Call Display

While busy on a call, the telephone display can show the identity of an incoming trunk or Intercom call. For incoming trunk calls, the display shows the Caller ID or ANI data or the trunk name if Caller ID or ANI are not installed. (Refer to [T1 Trunking \(with ANI/DNIS Compatibility\)](#) on page 2-1601 for more information.) For incoming Intercom calls, the display shows the calling extension name.

Caller ID supports the Telco Called Number Identification (CNI) and Called Number Delivery (CND) service, when available. These services provide the Caller ID information (i.e., messages) between the first and second ring burst of an incoming call. Two types of Caller ID message formats are currently available: Single Message Format and Multiple Message Format. With Single Message Format, the Telco sends only the caller's telephone number (DN). The DN has seven or 10 digits. In Multiple Message Format, the Telco sends the DN and the caller's name. The DN for this format also has seven or 10 digits, and the name provided consists of up to 15 ASCII characters.

The telephone display can show up to 12 Caller ID digits (for non-Contact Center calls).

- Once installed and programmed, Caller ID is enabled for all trunk calls, including: Ring Group calls
- Calls transferred from another extension
- Calls transferred from the VRS
- Calls transferred from Voice Mail (unscreened)
- Direct Inward Lines (DILs)

Caller ID temporarily stores 50 calls (total of abandoned and answered/unanswered). New calls replace old calls when the buffer fills.

### Temporary Memory

An unanswered call causes the Call History key (Program 15-07 or SC 751: 08) to flash, to indicate a new call was placed in the temporary memory. If enabled in programming, the telephone display shows CHECK LIST.

This Caller ID data from the temporary memory can be saved in either Speed Dial bins or in One-Touch keys making them available for placing future calls.

## Cursor Key Operation

By pressing the Left Cursor Key the user can access the Redial and Incoming Call History menus. The flow chart below shows the menu access sequence. If the terminal is not allowed to have the Dial Preview feature, these menus cannot be accessed.

Figure 2-1 Left Cursor Key Operation Flow Chart

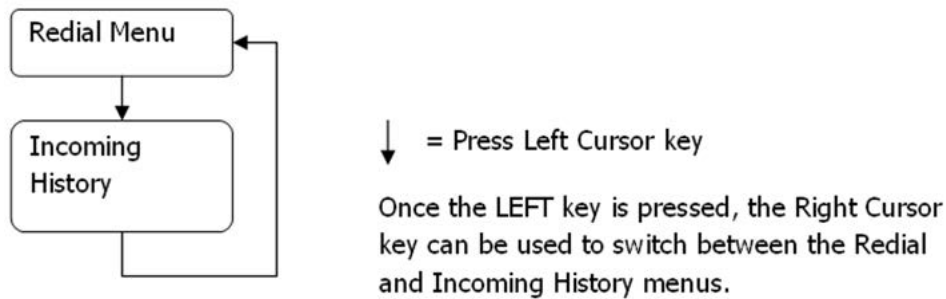

## Outputting Caller ID Data

The system includes the Caller ID data on the SMDR report. The report provides the incoming call DN in the DIALED NUMBER field. The CLASS field shows PIN (just like all other incoming calls).

Caller ID data can also output to a PC or other type of computer through the 1st-Party TAPI driver. This allows for off-line database lookups. In a customer service department, for example, the computer could search for a caller's records and display their account status even before a customer service representative picked up the telephone.

## Caller ID Digits to Voice Mail

A Caller ID/ANI trunk can send Remote Log-On Protocol with Caller ID digits to the voice mail. When a trunk 001 receives the Caller ID as 12345, the protocol becomes **\*\*\*60001\*12345\***.

## Display Reason for No Caller ID Information

With Caller ID enabled, the system provides information for analog calls that do not detect the Caller ID information. If the Caller ID information is restricted, the telephone display shows PRIVATE. If the system cannot provide Caller ID information because Telco information is not detected, the display shows NO CALLER INFO.

## Calling Party Number Information

When using the Wireless DECT (SIP) telephone, the system can provide the Caller ID information for an external call if it is provided by the Telco.

## Option to Enable Caller ID Name for SLT

System programming provides an option for single line telephones to display Caller ID.

## Add Trunk Access Code to Caller ID with Wireless DECT (SIP) – Phones

UNIVERGE SV9100 SIP DECT Phones on the UNIVERGE SV9100 can hold incoming call history. This history is created based on the Caller ID information element contained in the call Setup message which is transmitted from the UNIVERGE SV9100. This information allows users to return calls dialing the number stored.

The stored number, however, does not contain the trunk access code. Without this code, the system may not be able to seize an outside line to complete the call.

With this feature, when an Wireless DECT (SIP) user receives an incoming trunk call, the trunk access code defined in programming can be added to the Caller ID. This allows the system to seize an outside line and then dial the stored number.

- This function is applied only to incoming ISDN calls. It does not apply to incoming extension calls.
- Caller ID must be available for this feature to work.
- The maximum number of Caller ID digits is 20. If the total number of digits [trunk access code (Program 10-02-05) and Caller ID] is over 20, the remaining Caller ID digits are not dialed.

For example:

Trunk Access Code (Program 10-02-05): 123456##\* (eight digits)

Incoming Caller ID: 12345678901234567890 (20 digits)

UNIVERGE SV9100 Wireless Dials: 123456##\*123456789012

- An additional digit (such as 1) may be required to complete the call (Program 10-02-04).

For example:

Incoming Caller ID shows: 2125551212.

If your area code is NOT 212, define a 1 in Program 10-02-04. When callback is executed, the system prefixes 1 on the digits dialed string.

## Caller ID Sender Queuing Added

The UNIVERGE SV9100 system can provide Caller ID (calling party number) to a single line telephone with a display.

The system can queue incoming calls to the single line telephone if the system Caller ID sender resources are busy.

If the single line telephone user lifts their handset while an incoming call is waiting in queue, they hear silence (no dial tone) and cannot dial out. When the single line telephone user goes back on-hook, the system immediately sends the queued call to the single line telephone without Caller ID.

### Conditions

- To have pre-answer Caller ID from the voice mail, the call must be an unscreened transfer.
- Caller ID is provided by the GCD-CP10. The GPZ-BS10 blade, which plugs into the chassis, can provide additional resources for Caller ID if needed.

- Caller ID Name can display up to 12 characters.
- Caller ID Number can display up to 11 characters.
- A Caller ID Number with more than 12 digits follows Program 20-19-01 (first 10 or the last 10 digits).
- Caller ID information can be stored in Speed Dialing or One-Touch bins.
- Caller ID can be displayed for incoming calls and transferred calls.
- ARS can block outgoing Caller ID information call-by-call. To do this, insert the Caller ID block code (e.g., 67) in the ARS Dial Treatments.
- Trunks with Privacy Release enabled display Caller ID until the call is answered. To view it after the call has been picked up, press the line key, which sets the call to private mode. To keep the call on Privacy Release, press the Help + Exit keys.
- An extension user can display the Caller ID information for a call in Park if Automatic Handsfree in Program 15-02-08 is set to 0 (Preselect).
- An extension user can display the Caller ID information for multiple incoming calls without answering the call by pressing the line key if Automatic Handsfree in Program 15-02-08 is set to 0 (Pre-select).
- Caller ID information outputs on the SMDR report.
- ANI/DNIS can use the Caller ID tables for routing. Refer to [T1 Trunking \(with ANI/DNIS Compatibility\) on page 2-1601](#) for more information.
- The system can send Caller ID digits to the voice mail if allowed in Program 14-02-10.
- When more than 20 characters are set in Program 20-20: Message Setup for Non-Caller ID Data, either the first or last character is missing (based on the entry in Program 20-19-01).
- If Program 20-09-06: Class of Service Options (Incoming Call Service): Incoming Time Display is set to 1 (On), the first line displays the time and date.
- When you shut down the system, incoming history data is cleared. But you can back up the history data by pressing **Speaker + # \* # 9**.
- Program 15-07-01 button (63) when enabled, removes the CPN from the setup message when making an outbound ISDN call, this is a toggle enable/disable button and can be used on a Call-by-Call basis. Programs 14-01-20, 14-01-21 and 20-08-15 are used for copper trunks only and can be set only per trunk/Class of Service.
- SLT users cannot block an incoming call based on the incoming Caller ID information on a station-by-station basis.
- The GCD-CP10 has 80 resources for DTMF receiving and Dial Tone detection. When a is GPZ-BS10 installed there are 64 resources available.
- When Program 10-09-01 is set to 0 (Common) and Program 14-02-10 (Caller ID) is set to 1 (Yes), all DTMF/Dial Tone Detection resources are always allocated to analog trunks, not analog extensions. However, if Program 14-02-10 (Caller ID) is set to 0 (No), all DTMF/Dial Tone Detection resources can be used for both analog trunks and analog extensions.

- For the Caller ID List to show calls to a station that received a busy tone, Program 15-02-57 must be set to 1 (On).
- When Program 15-02-57 is set to 1 (On) and Program 15-02-34 is set to 0 (Trunk), only outside calls are shown in the Caller ID List.
- Caller ID history is not updated for a phone which is in power cutting mode from the ecology feature. Once power is restored to the phone the caller ID history will start functioning again.
- The priority for the Large LED color for incoming calls is Programs 13-04-13, then 14-01-35 or 15-23-01.
- Large LED Illumination by CID (Program 13-04-13) only applies to ITL and ITZ terminals. DTL and DTZ terminals do not support Large LED Illumination by CID.
- Caller ID is not supported when transferring to a virtual extension that is set to call forward both ring.

### Default Settings

None

## System Availability

### Terminals

All Multiline Terminals

### Required Component(s)

- GCD-4COTB with GPZ-4COTF Daughter Board
- GCD-2BRIA with GPZ-2BRIA Daughter Board
- GCD-PRTA

## Related Features

- ↳ **Automatic Route Selection (ARS)**
- ↳ **Call Arrival (CAR) Keys**
- ↳ **Caller ID Call Return**
- ↳ **Conference, Voice Call/Privacy Release**
- ↳ **Park**
- ↳ **Speed Dial – System/Group/Station**

- ➔ **Station Message Detail Recording**
- ➔ **T1 Trunking (with ANI/DNIS Compatibility)**
- ➔ **InMail**

## Guide to Feature Programming

The **Level 1**, **Level 2** and **Level 3** columns indicate the programs that are assigned when programming this feature in the order they are most commonly used. These levels are used with PCPro and WebPro wizards for feature programming.

- Level 1 – these are the most commonly assigned programs for this feature.
- Level 2 – these are the next most commonly assigned programs for this feature.
- Level 3 – these programs are not often assigned and require an expert level working knowledge of the system to be properly assigned.

Program Number	Program Name/Description	Input Data	Default	Level		
				1	2	3
10-02-04	<b>Location Setup – Area Code</b> Enter the local area code.	Dial (maximum of eight digits) 0 ~ 9, *, #	No Setting		✓	
10-02-05	<b>Location Setup – Trunk Access Code</b> Enter the trunk access code digits required to place an outgoing call.	Dial (maximum of eight digits) 0 ~ 9, *, #	No Setting		✓	
10-09-01	<b>DTMF and Dial Tone Circuit Setup</b> Allocate the circuits (1 ~ 16 or 1 ~ 64) on the GCD-CP10 for either DTMF receiving or dial tone detection. <ul style="list-style-type: none"> <li>➤ <i>The GCD-CP10 has 80 resources for DTMF receiving and Dial Tone detection. When a GPZ-BS10 is installed there are 64 resources available.</i></li> <li>➤ <i>When Program 10-09-01 is set to 0 (Common) and Program 14-02-10 (Caller ID) is set to 1 (Yes), all DTMF/Dial Tone Detection resources are always allocated to analog trunks, not analog extensions. However, if Program 14-02-10 (Caller ID) is set to 0 (No), all DTMF/Dial Tone Detection resources can be used for both analog trunks and analog extensions.</i></li> </ul>	0 = Common Use 1 = Extension Only 2 = Trunk Only	Circuit/Resource 01 ~ 08 = 1 (Extensions) Circuit/Resource 09 ~ 32 = 2 (Trunks) Circuit/Resource 33 ~ 144 = 0 (Common) When GPZ-BS10 is installed, 81 ~ 144 are available		✓	
11-15-03	<b>Service Code Setup, Administrative (for Special Access) – Backup Data Save</b> This service code is used to back up the programmed data on the SRAM and Call History to the Flash ROM. While saving the database, it may cause system lock up.	MLT 0 ~ 9, *, # Maximum of eight digits	# * # 9		✓	

Program Number	Program Name/Description	Input Data	Default	Level		
				1	2	3
13-04-13	<p><b>Speed Dialing Number and Name – Large LED Illumination Setup by (CID)</b>                      Define the color the large LED will blink when Incoming call with matching Caller ID is received.</p> <p>➡ <i>This feature applies only to ITL and ITZ terminals. DTL and DTZ terminals do not support Large LED Illumination by CID.</i></p>	1 = Not used 2 = Red 3 = Green 4 = Blue 5 = Yellow 6 = Purple 7 = Light Blue 8 = White 9 = Rotation 0 = No Setting	No Setting		✓	
14-01-20	<p><b>Basic Trunk Data Setup – Block Outgoing Caller ID</b>                      Enable/Disable the system from automatically blocking outgoing Caller ID information when a user places a call. If allowed (i.e. block, enabled), the system automatically inserts the Caller ID block code (defined in 14-01-21) before the user dialed digits.                      If prevented (i.e., block disabled), the system outdials the call just as it was dialed by the user.</p>	Trunks 1 ~ 400 0 = Disable 1 = Enable	0		✓	
14-01-21	<p><b>Basic Trunk Data Setup – Caller ID Block Code</b>                      Enter the code, up to eight digits, that should be used as the Caller ID Block Code. This code is automatically inserted before dialed digits if Program 14-01-20 is set to '1'.</p>	Trunks 1 ~ 400 Dial (maximum of eight digits)	*67		✓	
14-01-22	<p><b>Basic Trunk Data Setup – Caller ID to Voice Mail</b>                      Enable/Disable the system ability to send the Caller ID digits to voice mail.</p>	Trunks 1 ~ 400 0 = Disable 1 = Enable	0		✓	
14-01-24	<p><b>Basic Trunk Data Setup – Trunk-to-Trunk Outgoing Caller ID through Mode</b>                      This command is for PRI and SIP trunks only and should never be enabled on any other trunk type. When this command is enabled the system will pass the originating callers caller ID on to the Telco if the call is forwarded out of the system.</p> <p>➡ <i>Some Telco offices do not support this and will replace the number you send them with the main billing number.</i></p>	0 = Disable (No) 1 = Enable (Yes)	0	✓		
14-02-10	<p><b>Analog Trunk Data Setup – Caller ID</b>                      Enable (1) or Disable (0) a trunk to receive Caller ID information.</p>	Trunks 1 ~ 400 0 = No 1 = Yes	0	✓		
15-02-08	<p><b>Multiline Telephone Basic Data Setup – Automatic Handsfree</b>                      Set whether pressing a key accesses a One-Touch Key (1) or preselects the key (0).</p>	0 = Preselect 1 = One-Touch (Automatic Handsfree)	1		✓	

Program Number	Program Name/Description	Input Data	Default	Level		
				1	2	3
15-02-15	<b>Multiline Telephone Basic Data Setup – Storage of Caller ID for Answered Call</b> Enable (1) or Disable (0) ability of extension to store Caller ID for answered calls.	0 = Disable 1 = Enable	1	✓		
15-02-40	<b>Multiline Telephone Basic Data Setup – Additional Dial for Caller ID Call Return</b> Enter the digits to be dialed in front of the Caller ID when using Caller ID Call Return.	Maximum of four digits (0, 1~9, #, *)	No Setting		✓	
15-02-57	<b>Multiline Telephone Basic Data Setup – Caller Log on Busy</b> When a call to a station returns busy to the caller, turn On or Off if the call should be logged in the Call history log as a busy call.	0 = Off 1 = On	1		✓	
15-03-09	<b>Single Line Telephone Basic Data Setup – Caller ID Function – For External Module</b> Enable/Disable the Caller ID FSK signal for an external Caller ID module or a 3rd-Party vendor telephone with Caller ID display. If voice mail is used, this setting must be disabled or the system integration codes for disconnect are incorrect. For Caller ID Sender Queuing, set this option to “1”.	0 = Disable 1 = Enable	0		✓	
15-03-10	<b>Single Line Telephone Basic Data Setup – Caller ID Name</b> Determine whether or not a single line telephone should display the Caller ID name.	0 = Disable 1 = Enable	1		✓	
15-07-01	<b>Programmable Function Keys</b> Assign functions to multiline terminal line keys.	Line Key 1 ~ 48 0 ~ 99 (Normal Function Code 751 by default) *00 ~ *99 (Appearance Function Code) (Service Code 752 by default)	Refer to the Programming Manual for default values.		✓	
20-02-08	<b>System Options for Multiline Telephones – LCD Display Holding Time</b> Determine the time a user display shows Caller ID for a second incoming call.	0 ~ 64800 seconds	5		✓	
20-06-01	<b>Class of Service for Extensions</b> Assign a Class of Service (1 ~ 15) to extensions.	Day Night/Mode: 1 ~ 8 Class of Service of Extensions (1 ~ 15)	Extension port 101 = Class 15 All other extension port = Class 1		✓	



Program Number	Program Name/Description	Input Data	Default	Level		
				1	2	3
20-08-15	<p><b>Class of Service Options (Outgoing Call Service) – Block Outgoing Caller ID</b></p> <p>Turn Off or On a user Class of Service from automatically blocking outgoing Caller ID information when a call is placed. If block is enabled, the system automatically inserts the Caller ID block code *67 (defined in Program 14-01-21) before the user dialed digits (this requires Program 14-02-10 to be enabled). If block is disabled, the system outdials the call just as it was dialed by the user.</p>	<p>0 = Off 1 = On</p>	COS 1 ~ 15 = 0		✓	
20-09-02	<p><b>Class of Service Options (Incoming Call Service) – Caller ID Display</b></p> <p>Turns Off or On the Caller ID display at an extension.</p>	<p>0 = Off 1 = On</p>	COS 1 ~ 15 = 0	✓		
20-09-04	<p><b>Class of Service Options (Incoming Call Service) – Notification for Incoming Call List Existence</b></p> <p>Determine whether or not the CHECK LIST message is displayed to indicate a missed call.</p>	<p>0 = Off 1 = On</p>	COS 1 ~ 15 = 0		✓	
20-13-06	<p><b>Class of Service Options (Supplementary Service) – Automatic Off-Hook Signaling (Automatic Override)</b></p> <p>Allow a busy extension user to Manually (0) or Automatically (1) receive off-hook signals.</p> <p>➡ <i>This setting is to receive incoming call signaling information during call queuing.</i></p>	<p>0 = Off 1 = On</p>	COS 1 ~ 15 = 1		✓	
20-19-01	<p><b>System Options for Caller ID – Caller ID Displaying Format (If displaying digits are more than 12 digits)</b></p> <p>Determine whether the first 10 digits or last 10 digits should be displayed when Caller ID exceeds 12 digits.</p>	<p>0 = First 10 digits (Upper) 1 = Last 10 digits (Lower)</p>	0		✓	
20-19-05	<p><b>System ID Options for Caller ID – Caller ID Sender Queuing Time (Sender Wait)</b></p> <p>With the Caller ID Sender Queuing option, determine the time an incoming call waits in queue for a DSP resource to become available. If a resource becomes available during this time, the call immediately rings the single line telephone with Caller ID. If the time expires before a resource becomes available, the system rings the single line telephone without Caller ID (until the queuing time expires, the single line telephone does not ring). If the queuing timer is set to 0, the system does not queue the incoming call.</p>	0 ~ 64800 seconds	0		✓	

Program Number	Program Name/Description	Input Data	Default	Level		
				1	2	3
20-20-01	<b>Message Setup for Non-Caller ID Data – Private Call</b> Enter the text to be displayed for Caller ID when a user receives a call which is classified as a private call.	24 Alphanumeric Characters	PRIVATE		✓	
20-20-02	<b>Message Setup for Non-Caller ID Data – Call from Out of Service Area</b> Enter the text to be displayed for Caller ID when a user receives a call which is classified as an out-of-service area call.	24 Alphanumeric Characters	OUT OF AREA		✓	
20-20-03	<b>Message Setup for Non-Caller ID Data – Call Information with Error</b> Enter the text to be displayed for Caller ID when a user receives a call which is classified as a call with a CID error.	24 Alphanumeric Characters	NO CALLER INFO		✓	
90-03-01	<b>Save Data</b> Save the programmed data on the SRAM and Flash ROM to the 16MB/32MB ATA removable Compact Flash memory card. Also, used to save stored Caller ID if permanently saved with service code <b>##9</b> (11-15-03). ➤ <i>This program is available only via telephone programming and not through PC Programming.</i>	Dial <b>1</b> + press <b>Transfer</b> (Press <b>Transfer</b> to cancel.)	No Setting		✓	
90-04-01	<b>Load Data</b> Load the system data from the inserted Compact Flash Memory to the SRAM and Flash ROM in the system. Also, used to load stored Caller ID. ➤ <i>This program is available only via telephone programming and not through PC Programming.</i>	Dial <b>1</b> + press <b>Transfer</b> (Press <b>Transfer</b> to cancel.)	No Setting		✓	

## Operation

### Storing a Number

#### To store a Caller ID number in an Speed Dial bin:

1. With a multiline terminal idle, the display shows:

```

1-01 FRI 09:00AM
301           STA 301
LIST DIR VMsg ↓
    
```

2. Press the **LIST** Softkey.

- OR -

Press the **Left Cursor Key** twice and skip step 3. The display shows:

LIST MENU
Redial CID

3. Press the **CID** Softkey (Caller ID). The display shows:

##:	XXXXXXXXXXXX
	mm-dd hh:mm
↑	↓
Store	DEL

## = List Number

xx = Caller ID number

mm-dd hh:mm = incoming date and time

↑ = Preview List

↓ = Next List

Store = Store in List

DEL = Delete from List

4. Press the **STORE** Softkey. The display shows:

##:	XXXXXXXXXXXX	
	mm-dd hh:mm	
STA	Abb	TELBK

## = List Number

xx = Caller ID number

mm-dd hh:mm = incoming date and time

STA = Store in Station Speed Dial bin.

ABB = Store in Abbreviated Dial bin.

TELBK = Store in Telephone Book.

5. Press the **STA** or **ABB** or **TELBK** Softkey. The display shows:

Store to ABB: COMMON
ENTER BIN

6. Dial the Speed Dial bin in which the number is to be stored. If you press **Hold**, the next available Speed Dial bin is used. The display shows:

ABB XXXX:
XXXXXXXXXXXX

◇ If all Speed Dial bins are used, the display shows *TABLE IS FULL*.

7. Press **HOLD**. The display shows:

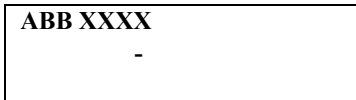

8. Enter the name to be associated with the stored number.

Table 2-8 Keys for Entering Names

Use this keypad digit . . .	When you want to . . .
1	Enter characters: 1 @ [ ¥ ] ^ _ ` {   } Æ ¨ Á À Â Ã Ç É Ê Ì Ó
2	Enter characters: <b>A-C, a-c, 2.</b>
3	Enter characters: <b>D-F, d-f, 3.</b>
4	Enter characters: <b>G-I, g-i, 4.</b>
5	Enter characters: <b>J-L, j-l, 5.</b>
6	Enter characters: <b>M-O, m-o, 6.</b>
7	Enter characters: <b>P-S, p-s, 7.</b>
8	Enter characters: <b>T-V, t-v, 8.</b>
9	Enter characters: <b>W-Z, w-z, 9.</b>
0	Enter characters: 0 ! “ # \$ % & ’ ( ) ô Õ ú ä ö ü α ε θ
*	Enter characters: * + , - . / : ; < = > ? π Σ σ Ω ∞ € £
#	# = Accepts an entry (only required if two letters on the same key are needed - ex: TOM). Pressing # again = Space. (In system programming mode, use the right arrow Softkey instead to accept and/or add a space.)
Feature	Clear the character entry one character at a time.
<b>HOLD (Telpro only)</b>	Clear all the entries from the point of the flashing cursor and to the right.

9. Press **Transfer**. The display shows:



10. Press **Speaker**.

◇ *The telephone returns to idle.*

**To store a Caller ID number in a One-Touch key:**

1. With a telephone idle, the display shows:

1-01 FRI 09:00AM	
301	STA 301
LIST DIR VMsg	↓

2. Press the **LIST** Softkey.

- OR -

Press the **Left Cursor Key** twice and skip step 3. The display shows:

LISTIMENU
Redial CID

3. Press the **CID** Softkey (Caller ID). The display shows:

##:	XXXXXXXXXXXX
	mm-dd hh:mm
↑ ↓	Store DEL

**##** = List Number

**xx** = Caller ID number

**mm-dd hh:mm** = incoming date and time

↑ = Preview List

↓ = Next List

**Store** = Store in List

**DEL** = Delete from List

4. Press the **STORE** Softkey. The display shows:

##:	XXXXXXXXXXXX
	mm-dd hh:mm
STA Abb TELBK	

**##** = List Number

**xx** = Caller ID number

**mm-dd hh:mm** = incoming date and time

**STA** = Store in Station Speed Dial bin.

**ABB** = Store in Abbreviated Dial bin.

**TELBK** = Store in Telephone Book.

5. Press the **STA** or **ABB** or **TELBK** Softkey. The display shows:

Store to Personal ABB
ENTER BIN

6. Press the **One-Touch** key in which the number is to be stored or dial **1~9, 0**. If you press **Hold**, the next available One-Touch key is used. The display shows:

Key ##: XXXXXXXXXXXX
-------------------------

◇ *If all One-Touch keys are used, the display shows TABLE IS FULL.*

7. Press **Hold**. The display shows:

KEY ## -
-------------

8. Enter the name to be associated with the stored number. Refer to [Table 2-8 Keys for Entering Names on page 2-120](#).

9. Press **Hold**. The display shows:

KEY PROG    STA
-----------------

10. Press **Speaker**.

◇ *The telephone returns to idle.*

### Temporary Memory

An unanswered call causes the Call History key (Program 15-07 or SC 751: 08) to flash, indicating a new call was placed in the temporary memory. If enabled in programming, the telephone display shows CHECK LIST.

1. Press the **Call History** key (Program 15-07 or SC 751: 08),

- OR -

Press the **LIST** Softkey and CID.

- OR -

Press the **Left Cursor Key** twice.

◇ *The last addition to the list is displayed.*

2. Press the **ARROW DOWN** Softkey to scroll through the list of numbers in memory.
3. Press the **DEL** Softkey to delete the entry and scroll to the next entry.
4. The **Call History** key remains on as long as entries remain in memory.
5. To place a call back to a number in the temporary memory list, with the number to be dialed displayed, press a line key or **Speaker**. (Refer to [Table 2-8 Keys for Entering Names on page 2-120](#).)

◇ *The outgoing call is placed.*

**To display Caller ID for a call in Park:**



*Program 15-02-08 is set to 0 (preselect) for this feature.*

NOTE

1. With Program 15-02-08 set to 0 (preselect) and a call in park, press the PARK key. (Program 15-07 or SC 752: \*04.  
With Program 15-02-08 set to 1 (One-Touch) and a call in park, press RECALL then the PARK key (Program 15-07 or SC 752 \*04).

**Checking your Answered/Unanswered Caller ID Calls:**

**To review the last 50 outside calls your extension received:**

1. At a display multiline terminal, press the **LIST** Softkey.  
- OR -  
Press the **Left Cursor Key** twice and skip step 2.
2. Press **CID**.
  - ◇ *The first row of your display shows the Caller ID number. If there is an “\*” next to the call record number in the left-hand corner, this indicates that it is a call you missed (unanswered). The second row shows the date and time of the call.*
  - ◇ *Press the up and down softkeys to see the list of calls available in the buffer.*
3. If the Caller ID includes a name, you can press the **HELP** key to view the number of the caller.
4. To call the displayed number, press a **line/Call Appearance (CAP) Key**.  
- OR -  
To erase the displayed number without returning the call, press the **DEL** Softkey.
5. Press **Speaker** to hang up.

## Caller ID – Flexible Calling Party Number

### Description

With Version 4000 or higher software, the user can select the Calling Party Number (CPN) by using a function key. The CPN key must be enabled to use this feature. The assigned caller ID on a CPN key is sent over the specified trunk.

### Conditions

- Caller ID – Flexible Calling Party Number is not supported on analog trunks.
- This feature is only supported on terminals with programmable keys.
- Program 20-08-13 must be set to 1 (On) for this feature to work.
- Program 14-01-38 must be set to 0 (Contract Number) for this feature to work.
- If the outgoing trunk type is SIP, Program 10-29-14 must be set to a value other than 0 (Default).
- Multiple CPN Notification keys with different additional data can be assigned on the same terminal.
- When pressed, the CPN key turns red (Enabled). The assigned CPN is displayed on the second line of the LCD for the number of seconds defined in Program 20-02-08.
- On pressing the CPN Notification key to enable the assigned function, any previous CPN function is disabled.
- This feature will not work if Program 14-01-38 is set to 0 (Contract Number) and the CPN notification key is disabled or, if Program 14-01-38 = (1~5). Caller ID is sent using Programs 21-12-01, 21-13-01, 21-17-01, 21-18-01, 21-19-01 and 21-25-01.
- All enabled CPN keys are disabled when the system reboots.
- Caller ID – Flexible Calling Party Number is not supported with virtual extensions.

### Default Settings

None



## System Availability

### Terminals

All Multiline Terminals

### Required Component(s)

- 0414 – SV9100 Version Lic (R4)
- GPZ-IPLE
- GCD-PRTA

## Related Features

None

## Guide to Feature Programming

The **Level 1**, **Level 2** and **Level 3** columns indicate the programs that are assigned when programming this feature in the order they are most commonly used. These levels are used with PCPro and WebPro wizards for feature programming.

- Level 1 – these are the most commonly assigned programs for this feature.
- Level 2 – these are the next most commonly assigned programs for this feature.
- Level 3 – these programs are not often assigned and require an expert level working knowledge of the system to be properly assigned.

Program Number	Program Name/Description	Input Data	Default	Level		
				1	2	3
10-29-14	<p><b>SIP Server Information Setup – SIP Carrier Choice</b></p> <p>Define the SIP Carrier Choice.</p> <ul style="list-style-type: none"> <li>➤ <i>Selecting Carrier B automatically sets Program 10-29-16 to on (1). Program 10-29-16 MUST be set to off for incoming calls to route using the lowest available trunk port.</i></li> <li>➤ <i>Each certified vendor may use a different carrier type. Visit NTAC website (<a href="http://www.necntac.com">http://www.necntac.com</a>) to verify the proper setting per vendor.</i></li> </ul>	<p>0 ~ 26 1 ~ 26 = Carrier Type A ~ Carrier Type Z</p> <p>Profile 1 ~ 2 (Version 2000 or lower) Profile 1 ~ 6 (Version 3000 or higher)</p>	0	✓		

Program Number	Program Name/Description	Input Data	Default	Level		
				1	2	3
14-01-38	<p><b>Basic Trunk Data Setup – Outgoing CLI Selection</b></p> <p>Select CLI (Calling Party Number) sending way to trunk.</p> <p>When set to 0, extension CLI number set in Program 21-13-01, Program 21-18-01 or Program 21-19-01 is sent according to seized trunk type (ISDN/H.323/SIP) automatically.</p> <p>When set to 1, calling extension number is sent as CLI.</p> <p>When set to 2, extension table number set in Program 21-25-01 is sent as CLI.</p> <p>When set to 3, 4, or 5, extension CLI number set in Program 21-13-01, Program 21-18-01 or Program 21-19-01 is sent to seized trunk regardless of trunk type.</p>	0 = Contract Number 1 = Extension Number 2 = Extended Table 3 = PRG 21-13 4 = PRG 21-18 5 = PRG 21-19 6 = No digits	0	✓		
15-01-04	<p><b>Basic Extension Data Setup – ISDN Caller ID</b></p> <p>If both Program 15-01-04 and Program 10-03-05 are Enabled, the system includes Caller ID in the Setup message as Presentation Allowed. If these options are Disabled, it is Presentation Restricted.</p>	0 = Disable 1 = Enable	1		✓	
15-07-01	<p><b>Programmable Function Keys</b></p> <p>Assign a function key as a CPN key (code #13). User should enable this key to send the assigned caller ID.</p>	Line Key 1 ~ 48 0 ~ 99 (Normal Function Code 751 by default) *00 ~ *99 (Appearance Function Code) (Service Code 752 by default)	Refer to the Programming Manual for default values.	✓		
20-08-13	<p><b>Class of Service Options (Outgoing Call Service) – ISDN CLIP</b></p> <p>Determine if the ISDN calling line identity presentation and screening indicators are to be allowed.</p>	0 = Off 1 = On	0	✓		
21-12-01	<p><b>ISDN Calling Party Number Setup for Trunks</b></p> <p>Assign Calling Party Numbers for each trunk (maximum 16 digits per entry). When a call is made by an extension which does not have an Extension Calling Number assigned (Program 21-13), the system sends the calling number for the ISDN trunk defined in 21-12. If the Calling Party Number is assigned in both Program 21-12 and Program 21-13, the system sends the data in Program 21-13.</p>	Maximum of 16 characters (0 ~ 9, *, #)	All Trunks = No Setting		✓	

Program Number	Program Name/Description	Input Data	Default	Level		
				1	2	3
21-13-01	<p><b>ISDN Calling Party Number Setup for Extensions</b></p> <p>Assign each extension a Calling Party Number (maximum 16 digits per entry). The calling number is the subscriber number of the dial-in number. When a call is made by an extension which does not have an Extension Calling Number assigned (Program 21-12), the system sends the calling number for the ISDN trunk defined in Program 21-13. If a Calling Party Number is assigned in both Program 21-12 and Program 21-13, the system sends the data in Program 21-13.</p>	Maximum of 16 characters (0 ~ 9, *, #)	No Setting		✓	
21-17-01	<p><b>IP Trunk (SIP) Calling Party Number Setup for Trunk</b></p> <p>Assign the Caller Party Number for each IP trunk. The assigned number is sent to the central office when the caller places an outgoing call. If the Calling Party Number is assigned by both Program 21-17 and Program 21-18/ 21-19, the system uses the entry in Program 21-18/21-19.</p>	Maximum of 16 characters (0 ~ 9, *, #)	No Setting		✓	
21-18-01	<p><b>IP Trunk (H.323) Calling Party Number Setup for Extension</b></p> <p>Assign the Calling Party Number for each extension. The assigned number is sent to the exchange when the caller places an outgoing call.</p>	Maximum of 16 characters (0 ~ 9, *, #)	No Setting		✓	
21-19-01	<p><b>IP Trunk (SIP) Calling Party Number Setup for Extension</b></p> <p>Assign the Calling Party Number for each extension. The assigned number is sent to the central office when the caller places an outgoing call. If the Calling Party Number is assigned by both Program 21-17 and Program 21-18/Program 21-19, the system uses the data in Program 21-18/Program 21-19.</p>	Maximum of 16 characters (0 ~ 9, *, #)  Profile 1 ~ 2 (Version 2000 or lower) Profile 1 ~ 6 (Version 3000 or higher)	No Setting		✓	
21-25-01	<p><b>Expansion Calling Party Setup for Extension</b></p> <p>Assign CLI number to each extension. This program is used only when Program 14-01-38 is set to 2.</p>	Maximum of 16 characters (0 ~ 9, *, #)	No Setting		✓	
30-03-01	<p><b>DSS Console Key Assignment</b></p> <p>Customize DSS Console keys to function as DSS keys, Service Code keys, Programmable Function Keys and One-Touch Calling keys. When programming a feature within a One-Touch Key, refer to the feature description for additional programming options. Assign #13 for CPN function key.</p>	Key Number 001 ~ 114 0 ~ 99 (General Functional Level) 97 = Door Box Access key (additional data: 1 ~ 8 Door Box No.) * 00 ~ * 99 (Appearance Functional Level)	Refer to the Programming Manual for default values.	✓		

## Operation

### To set CPN key:

1. Assign a CPN key (Program 15-07-01, or SC 751:#13+CPN).
  - ◇ When assigning CPN Key (#13) by SC, press the **Hold** key to assign the CPN.
2. Press the CPN key to enable.
  - ◇ The CPN key turns red and the calling party number is displayed.

### To send the Caller ID assigned on CPN key:

1. Press (enable) the assigned CPN key.
2. Make an outgoing call. System sends the calling party number assigned on CPN key to the PSTN.

### To cancel CPN key:

1. Press enabled CPN key.
  - ◇ CPN key turns off (disabled).

### To check CPN key name:

1. Press [Help] + [CPN notification key (#13)].  
On 28 Digit LCD

CHECK	LINE KEY 18
CPN:123456789012345678901234	

## Caller ID – Flexible Ringing

### Description

The Caller ID – Flexible Ringing feature provides several different options for rerouting calls based on the Caller ID received.

#### Reject/Reroute “Private” Caller ID Calls

When an analog or ISDN trunk call is received with “Private” Caller ID information, the SV9100 can reject the call by playing a VRS message or it can route the call to an alternative extension or incoming ring group programmed in Program 22-18-01.

#### Reject/Reroute Based on Entry in SPD Table

When an analog, ISDN or IP trunk call is received with regular Caller ID information, the SV9100 can reject the call by playing a VRS message if the Caller ID number matches the Speed Dial group number programmed in Program 22-16-01 and Speed Dial entry in Programs 13-02-01 and 13-04-01. The analog, ISDN or IP trunk call can also be routed to an alternative extension or incoming ring group if the Caller ID number matches the common or group Speed Dial table (Program 13-04).

This option can block calls on all trunks or it can be set on a per-trunk basis.

#### Programming Examples for Flexible Ringing by Caller ID:

- ❑ To refuse the “Private” Caller ID incoming call:
  - Program 14-01-27: 1 (reject)
  - Program 20-07-24: 1 (Enable for COS)
  - Program 22-18-01: 0 (no transfer)
  - Program 40-10-06: 2 (VRS message 2)

then,

Turn on the Private Call Refuse mode using the service code (Program 11-10-32) or Programmable Function Key (code 86).

- ❑ To transfer the “Private” Caller ID incoming call to extension 301 as ring pattern 2:
  - Program 14-01-27: 1 (reject)
  - Program 22-18-01: 1 (extension number)
  - Program 22-18-02: 301 (extension 301)
  - Program 22-18-03: 2 (ring pattern 2)

then,

Turn on the Private Call Refuse mode using the service code (Program 11-10-32) or Programmable Function Key (code 86).

- ❑ To transfer the “Private” Caller ID incoming call to incoming ring group 2 as ring pattern 3:  
 Program 14-01-27: 1 (reject)  
 Program 22-18-01: 2 (incoming ring group)  
 Program 22-18-02: 2 (group 2)  
 Program 22-18-03: 3 (ring pattern 3)

then,

Turn on the Private Call Refuse mode using the service code (Program 11-10-32) or Programmable Function Key (code 86).

- ❑ To reject the call with “2142622000” Caller ID incoming call:  
 Program 14-01-27: 1 (reject)  
 Program 20-07-25: 1 (Enable for COS)  
 Program 22-16: 64 (Speed Dial group 64)  
 Program 13-02; Group 64: 1000 - 1099  
 Program 13-04-01; Table 1000: 2142622000

then,

Turn on the Caller ID Refuse mode using the service code (Program 11-10-34) or Programmable Function Key (code 87).

- ❑ To transfer the call with “2142622000” Caller ID incoming call to extension 301 as ring pattern 1:  
 Program 13-04-01: 2142622000  
 Program 13-04-03: 1 (extension number)  
 Program 13-04-04: 301 (extension 301)  
 Program 13-04-05: 1 (tone pattern 1)
- ❑ To transfer the call with “2142622000” Caller ID incoming call to incoming ring group 2 as ring pattern 2:  
 Program 13-04-01: 2142622000  
 Program 13-04-03: 2 (incoming ring group)  
 Program 13-04-04: 2 (group 2)  
 Program 13-04-05: 2 (tone pattern 2)

## Conditions

- Caller ID Matching.  
 The UNIVERGE SV9100 compares the Caller ID and programmed Speed Dial and allows/ denies as indicated below.
- The Speed Dial table is searched from the starting number and the first match result is used.
- The maximum number of VRS message channels that can be used simultaneously is 16. These channels are also shared with the voice mail.

- This feature does not work with incoming trunk calls via networking (from another system). In this case, the refuse/routing program must be programmed in the system that has those trunks. Routing to the other system's extension is available.
- When Program 13-04 is used; it will override the setting in Program 22-02-01: Incoming Call Trunk Setup.
- Program 13-04 will follow Common or Group Speed Dial numbers.

**Caller ID Matching Rule:**

The system compares the Caller ID and programmed Speed Dial with these rules below.

*Table 2-9 Caller ID Matching Rule*

Caller ID	Speed Dial	Result
2142622000	2142622000	Matched
2142622000	21426220009	Matched
2142622000	214	Matched
2622000	2142622000	Unmatched
2142622000	2622000	Unmatched

➔ *The Speed Dial table is searched from the starting number and the first match result is used.*

**Default Settings**

None

**System Availability**

**Terminals**

All Terminals

**Required Component(s)**

None

**Related Features**

➔ **Central Office Calls, Answering**

➔ **Direct Inward Dialing (DID)**

- ➔ **UM8000 Mail**
- ➔ **Voice Response System (VRS)**

## Guide to Feature Programming

The **Level 1**, **Level 2** and **Level 3** columns indicate the programs that are assigned when programming this feature in the order they are most commonly used. These levels are used with PCPro and WebPro wizards for feature programming.

- Level 1 – these are the most commonly assigned programs for this feature.
- Level 2 – these are the next most commonly assigned programs for this feature.
- Level 3 – these programs are not often assigned and require an expert level working knowledge of the system to be properly assigned.

Program Number	Program Name/Description	Input Data	Default	Level		
				1	2	3
11-10-32	<b>Service Code Setup (for System Administrator) – Set Private Call Refuse</b> Enable/Disable the Private Call Refuse (trunks) which are set in Program 14-01-27.	MLT, SLT 0 ~ 9, *, # Maximum of eight digits	No Setting		✓	
11-10-33	<b>Service Code Setup (for System Administrator) – Entry Caller ID Refuse</b> Add/Delete the Caller ID to refuse. ➔ <i>This operation must be performed from a Keyset.</i>	MLT 0 ~ 9, *, # Maximum of eight digits	No Setting	✓		
11-10-34	<b>Service Code Setup (for System Administrator) – Set Caller ID Refuse</b> Enable/Disable the Caller ID number (trunks) which are set in Program 14-01-27.	MLT, SLT 0 ~ 9, *, # Maximum of eight digits	No Setting	✓		
13-02-01	<b>Group Speed Dialing Bins</b> Designate the starting and ending bin numbers the system uses for Group Speed Dialing.	01 ~ 64 0 ~ 9999 Starting bin number range: 0 ~ 9990 Ending bin number range: 0 ~ 9999	No Setting	✓		
13-04-01	<b>Speed Dialing Number and Name – Speed Dialing Data</b> Enter the System and Group Speed Dialing numbers and names.	Maximum of 24 digits (0 ~ 9, *, #, @, P, R) @ = Wait for Answer Supervision - ISDN trunks only P = Pause - Analog Trunk Only R = Hook flash - Analog Trunk Only	No Setting	✓		
13-04-03	<b>Speed Dialing Number and Name – Transfer Mode</b> When the incoming caller ID matches the number programmed in the speed dial bin, this setting determines the destination of the call.	0 = Not Used 1 = Internal Dial 2 = Incoming Ring Group (IRG)	0	✓		



Program Number	Program Name/Description	Input Data	Default	Level		
				1	2	3
13-04-04	<b>Speed Dialing Number and Name – Transfer Destination Number</b> When the incoming caller ID matches the number programmed in the speed dial bin, this setting determines the destination of the call.	If Transfer mode is (Refer to 13-04-03): 1 = Internal Dial Mode 1 ~ 9, 0, *, #, P, R, @ (Maximum 24 Characters) 2 = Incoming Ring Group 0 ~ 100 (IRG Number) P = Pause R = Recall @ = Additional Digits when using ISDN functionality	No Setting	✓		
13-04-05	<b>Speed Dialing Number and Name – Incoming Ring Pattern</b> Define the ring tone for the caller ID routed call.	Incoming Ring Pattern 0 = Normal Pattern 1 ~ 4 = Tone Pattern (1 ~ 4) 5 ~ 9 = Scale Pattern (1 ~ 5) 10 ~ 13 = Tone Patterns (5 ~ 8)	0		✓	
14-01-27	<b>Basic Trunk Data Setup – Caller ID Refuse Setup</b> Define if the trunk will reject the call by playing the VRS message based on the Caller ID information.	0 = Disable (No) 1 = Internal Dial 2 = Enable (Yes)	0		✓	
15-07-01	<b>Programmable Function Keys</b> Assign function key 86 (Set Private Call Refuse) to Enable/Disable trunks which are set in Program 14-01-27 to “1”. Assign function key 87 (Set Caller ID Refuse) to Enable/Disable the Caller ID Refusal (trunks) which is set in Program 14-01-27 to “1”.	Line Key 1 ~ 48 0 ~ 99 (Normal Function Code 751 by default) *00 ~ *99 (Appearance Function Code) (Service Code 752 by default)	Refer to the Programming Manual for default values.	✓		
20-07-24	<b>Class of Service Options (Administrator Level) – Set/Cancel Private Call Refuse</b> Enable (1) or Disable (0) an extension user ability to set or cancel Private Call Refuse.	0 = Off 1 = On	COS 1 ~ 15 = 0	✓		
20-07-25	<b>Class of Service Options (Administrator Level) – Set/Cancel Caller ID Refuse</b> Enable/Disable an extension ability to set or cancel Caller ID Refuse.	0 = Off 1 = On	COS 1 ~ 15 = 0	✓		
40-10-06	<b>Voice Announcement Service Option – Set VRS Message for Private Call Refuse (VRS Msg Private Call)</b> Assign the VRS Message number used as Private Call Refuse. When Fixed message is set, VRS message guidance is: Service finished. Disconnect the line, please.	0 ~ 101 (0 = No message) (101 = Fixed message)	0		✓	

The Caller ID – Flexible Ringing Flowchart below helps define programming:

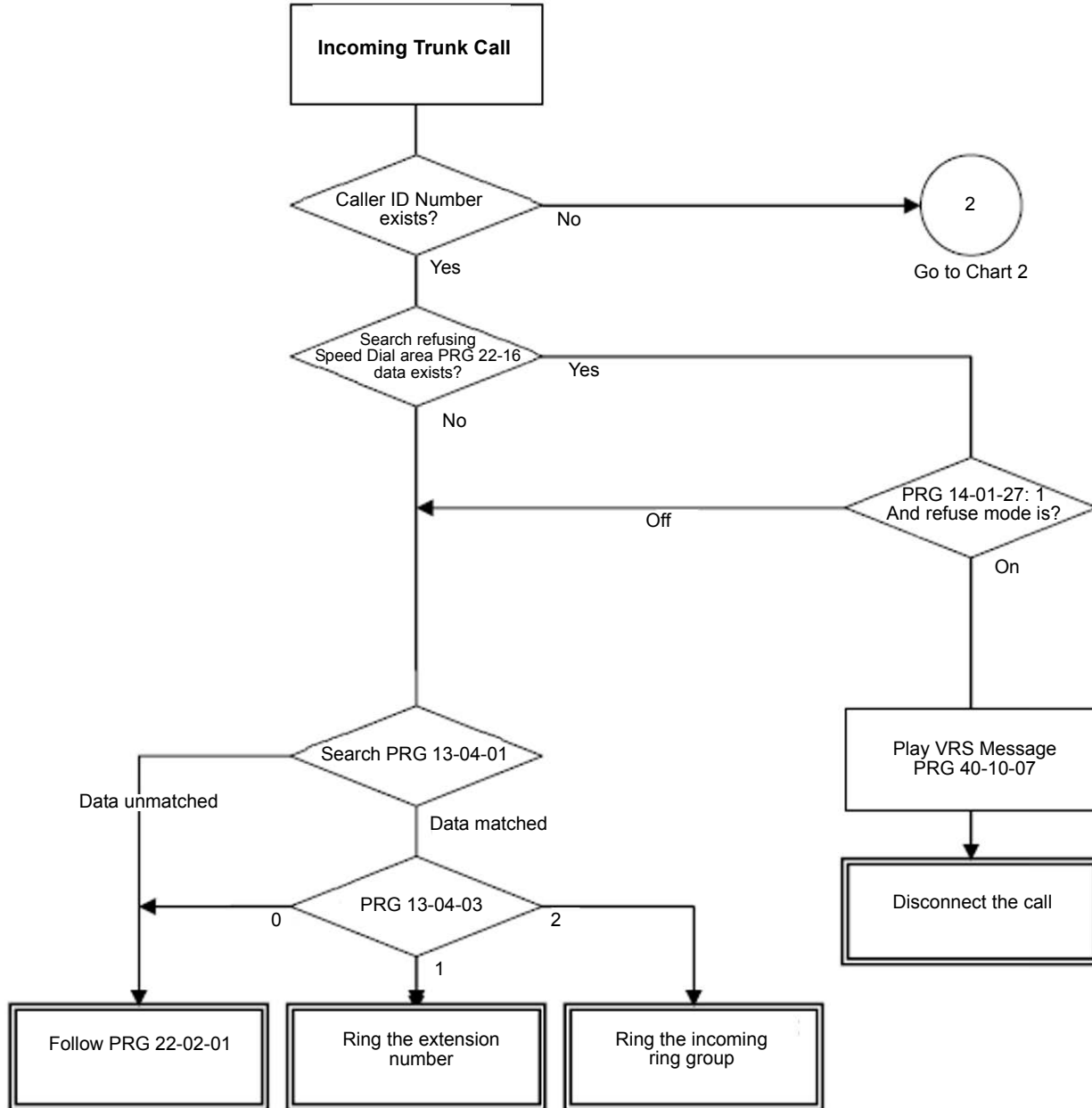

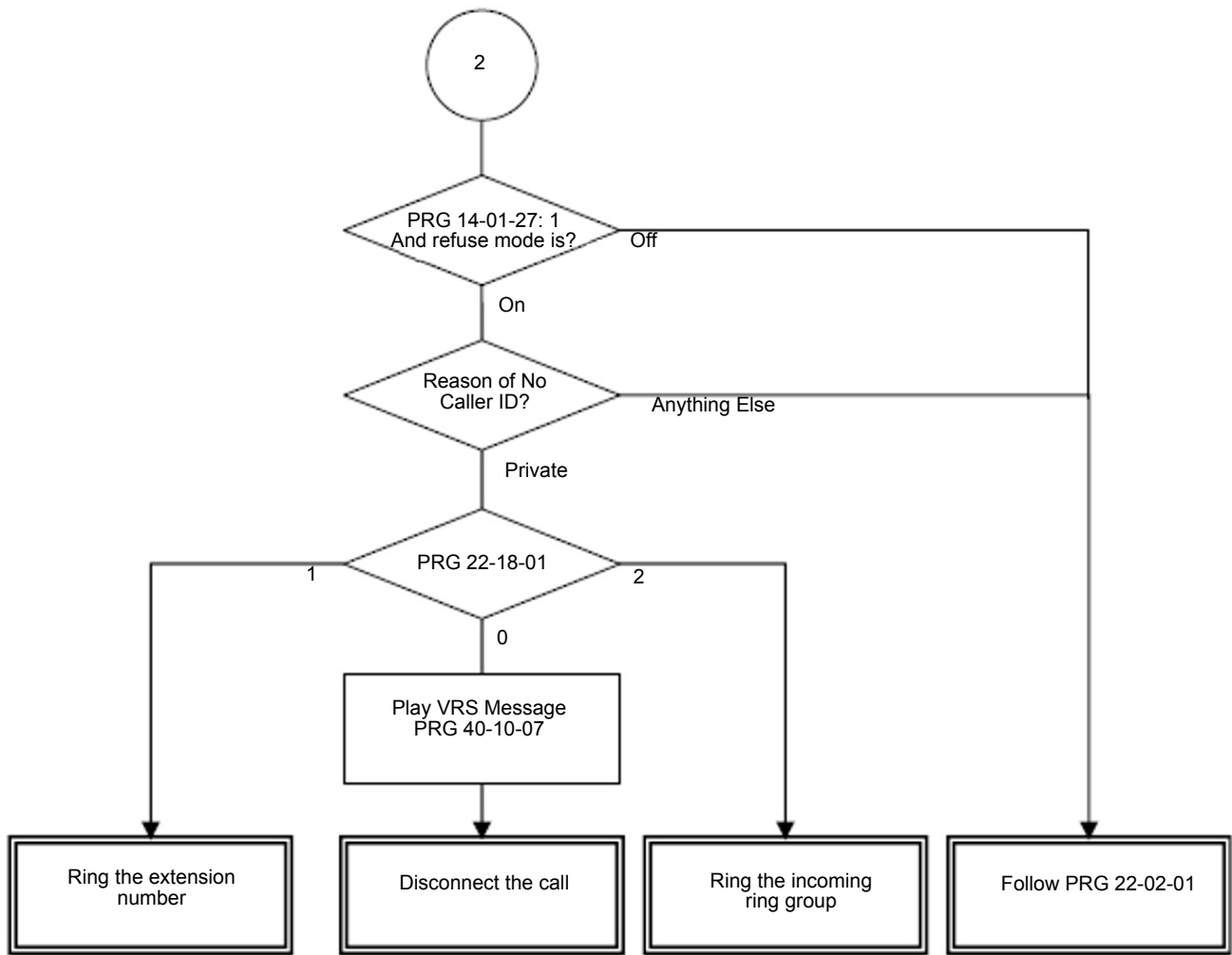

## Operation

None

## Caller ID – Memo Display Function

### Description

The SV9100 can display up to 28 Characters per line and up to three lines of information for a total of 84 characters (Maximum 28 digits x 3 lines). If needed, the system can be set to use any one of three available display lines. Additionally, the original CID information can be seen while on the call by pressing the right cursor button on the phone.

### Conditions

- The following priorities are used when determining what information to display for inbound CO calls with Caller ID information:
  1. Fixed Telco messages: “OUT OF AREA”, “PRIVATE” or “PAY PHONE”.
  2. Memo display settings for speed dial buffer in Program 13-04-08, 13-04-09 or 13-04-10.
  3. Calling party name provided by Telco.
  4. Abbreviated Dial Name stored in Program 13-04-02 for an inbound call with Caller ID number only.
- In a CCIS network the Memo Display Function is only supported for DID calls directed across CCIS to a remote system.
- Calls forwarded or transferred across CCIS do not support the Memo Display Function.
- Memo information cannot be programmed via telephone programming or service access code, only via Web Pro and PC Pro.
- The Memo Display function is only supported on Multiline terminals.
- The Memo Display function is only supported for incoming trunk calls with Caller ID information.
- The destination station must be idle for the Memo Display function to work.
- The Memo Display function will only search the Common Speed Dial bins, it will not search Group or Station speed dial bins.
- Find the abbreviation area the side of incoming system when trunk incoming via networking.
- When calls are directed to a virtual extension, the virtual extension must be set to ring for the Memo Display function to work.
- Pressing the right Cursor key on the telephone toggles the display between the actual incoming Caller ID information and the Memo Display settings for that incoming Caller ID information.
- When a call is on hold, pressing the Feature Key and the line key the call resides on displays the actual incoming Caller ID information.

- For an incoming call, the Memo Caller ID is displayed during the ring cycle. When answered, the original Caller ID is displayed.

### Default Settings

None

## System Availability

### Terminals

All Multiline Terminals

### Required Component(s)

- GCD-4COTB with GPZ-4COTF Daughter Board
- GCD-2BRIA with GPZ-2BRIA Daughter Board
- GCD-PRTA

## Related Features

- ↳ **Automatic Route Selection (ARS)**
- ↳ **Call Arrival (CAR) Keys**
- ↳ **Caller ID Call Return**
- ↳ **Conference, Voice Call/Privacy Release**
- ↳ **Park**
- ↳ **Speed Dial – System/Group/Station**
- ↳ **Station Message Detail Recording**
- ↳ **T1 Trunking (with ANI/DNIS Compatibility)**
- ↳ **InMail**

## Guide to Feature Programming

The **Level 1**, **Level 2** and **Level 3** columns indicate the programs that are assigned when programming this feature in the order they are most commonly used. These levels are used with PCPro and WebPro wizards for feature programming.

- Level 1 – these are the most commonly assigned programs for this feature.
- Level 2 – these are the next most commonly assigned programs for this feature.
- Level 3 – these programs are not often assigned and require an expert level working knowledge of the system to be properly assigned.

Program Number	Program Name/Description	Input Data	Default	Level		
				1	2	3
13-01-03	<b>Speed Dialing Option Setup – Number of Common Speed Dialing Bins</b> Designate the bins the system uses for System Speed Dialing.	0 ~ 10000 0 = No Common Speed Dialing	1000		✓	
13-04-01	<b>Speed Dialing Number and Name – Speed Dialing Data</b> Enter the System and Group Speed Dialing numbers and names.	Maximum of 24 digits (0 ~ 9, *, #, @, P, R) @ = Wait for Answer Supervision - ISDN trunks only P = Pause - Analog Trunk Only R = Hook flash - Analog Trunk Only	No Setting	✓		
13-04-08	<b>Speed Dialing Number and Name – Memo Display 1</b> This can only be set using Web Pro or PC Pro and determines what will be displayed on line 1 of the multiline telephone when Program 15-02-58 is set to memo.	Maximum of 28 characters	No Setting	✓		
13-04-09	<b>Speed Dialing Number and Name – Memo Display 2</b> This can only be set using Web Pro or PC Pro and determines what will be displayed on line 2 of the multiline telephone when Program 15-02-58 is set to memo.	Maximum of 28 characters	No Setting		✓	
13-04-10	<b>Speed Dialing Number and Name – Memo Display 3</b> This can only be set using Web Pro or PC Pro and determines what will be displayed on line 3 of the multiline telephone when Program 15-02-58 is set to memo.	Maximum of 28 characters	No Setting		✓	
15-02-58	<b>Multiline Telephone Basic Data Setup – Display Mode of Incoming Trunk</b> Determines if the incoming CID or the Memo 1/2/3 setting will be displayed for a matching CID number.	0 = Caller ID 1 = Memo Information	0	✓		

Operation

None

## Call Appearance (CAP) Keys

### Description

This feature automatically places an outside call on a Call Appearance key when the system is operated as a hybrid (Multifunction) system. These keys can be assigned on any multiline terminal or the same key can appear on multiple terminals. This feature allows efficient call handling when numerous CO calls are received and a limited number of CO line key appearances are available.

Once a Call Appearance (CAP) Key call is set up, the user can handle it like any other trunk call. For example, the user can place the call on hold, transfer it to a co-worker or send it to a park orbit. An incoming call is answered on the first available CAP key, beginning with the lowest numbered key. If keys 1~3 are Call Appearance (CAP) Keys, for example, the first incoming call is answered on key 1. If key 1 is busy, the next call is answered on key 2. If keys 1 and 2 are busy, the next call is answered on key 3. If all three keys are busy, additional incoming calls queue for the first available key.

### Conditions

- A trunk call that is originated or answered at a multiline terminal must appear on a line key. The line key can be assigned as the Trunk Key, or as a Call Appearance Key. A CAP is dynamic because it is used for any trunk call. An 8-button multiline terminal can have eight CAP keys that allow the telephone to process all trunks, eight trunks at a time.
- Multiline terminals can be assigned to the same CAP Key. Trunk calls that appear on the same CAP Key at multiple stations have the same visual appearance of the call (Busy or Hold).
- Any held call left on a CAP key for more than the programmed time recalls to the multiline terminal where the call was originally put on hold.
- When a multiline terminal (other than the one that originally initiated or received a call) is used to retrieve a held call, the SMDR records a transfer to the multiline terminal where the call was retrieved.
- Only outside lines use a CAP key.
- A multiline terminal can have multiple CAP keys assigned to it.
- Outside lines reside on the CAP key in the order of lowest to highest line key number on the station. For instance, when line keys 1, 2 and 3 are CAP keys, the first call resides on line key 1, the second call resides on line key 2 and third call resides on line key 3.
- All Flexible Line keys on a multiline terminal can be assigned as CAP keys in System Programming.
- A conference call involving two outside lines cannot reside on one Call Appearance key.
- For Call Appearance (CAP) Keys, trunks must be assigned to trunk group 1 or higher (Program 14-05-01). Trunk Group 0 means KF (Key Function) mode.



- CAP Keys can be programmed from 0001~9999. 0000 assigns the next available CAP Key.
- Trunk Group (\*02), Virtual Extension (\*03) and Call Appearance (CAP) Key (\*08), codes cannot be programmed on a DSS Console as the system does not allow entry of the additional data required.
- If you have both trunk line keys and Call Appearance (CAP) Keys, the line key has priority. An incoming call rings the trunk line key and when answered, the trunk line keys lights, not the CAP Key. When you access the trunk for an outgoing call, the Trunk line key lights, not the Call Appearance (CAP) Key.
- CAP keys can only be assigned or used if Program 20-02-23 is set to Original (0).
- A system can have only CAP keys or Loops keys.
- When SV telephones are installed, CAP key mode must be used. When UX telephones are installed, Loop key mode must be used.

### Default Settings

Disabled

## System Availability

### Terminals

SV9100 Terminals only

### Required Component(s)

None

## Related Features

- ↳ **Automatic Route Selection (ARS)**
- ↳ **Call Arrival (CAR) Keys**
- ↳ **Central Office Calls, Answering**
- ↳ **Central Office Calls, Placing**
- ↳ **Off-Hook Signaling**
- ↳ **Programmable Function Keys**
- ↳ **Secondary Incoming Extension**

- ➔ **User Programming Ability**
- ➔ **Video Conference with Web RTC**

## Guide to Feature Programming

The **Level 1**, **Level 2** and **Level 3** columns indicate the programs that are assigned when programming this feature in the order they are most commonly used. These levels are used with PCPro and WebPro wizards for feature programming.

- Level 1 – these are the most commonly assigned programs for this feature.
- Level 2 – these are the next most commonly assigned programs for this feature.
- Level 3 – these programs are not often assigned and require an expert level working knowledge of the system to be properly assigned.

Program Number	Program Name/Description	Input Data	Default	Level		
				1	2	3
15-07-01	<b>Programmable Function Keys</b> Assign functions to multiline terminal line keys.	Line Key 1 ~ 48 0 ~ 99 (Normal Function Code 751 by default) *00 ~ *99 (Appearance Function Code) (Service Code 752 by default)	Refer to the Programming Manual for default values.	✓		
20-02-23	<b>System Options for Multiline Telephones – UX5000 Phone Operation Mode</b> Selects the Loop Key operation like the UX5000 terminal, or the CAP Key operation like the SV9100 terminal.	0 = Original Operation Mode (CAP Key) 1 = UX5000 Special Operation Mode (Loop Key)	0	✓		
20-06-01	<b>Class of Service for Extensions</b> Assign a Class of Service (1 ~ 15) to extensions.	Day Night/Mode: 1 ~ 8 Class of Service of Extensions (1 ~ 15)	Extension port 101 = Class 15 All other extension port = Class 1		✓	
20-11-19	<b>Class of Service Options (Hold/Transfer Service) – Hold/Extended Park</b> Determine whether an extension Class of Service should allow normal or extended Park (0 = Normal for Program 24-01-06, 1 = Extended for Program 24-01-07).	0 = Off 1 = On	COS 1 ~ 15 = 0		✓	
24-01-01	<b>System Options for Hold – Hold Recall Time</b> A call on Hold recalls the extension that placed it on Hold after this time. This time works with the Hold Recall Callback Time.	0 ~ 64800 seconds	90		✓	
24-01-02	<b>System Options for Hold – Hold Recall Callback Time</b> A call that is parked longer than the programmed time recalls the extension where it was initially parked.	0 ~ 64800 seconds	30		✓	

Program Number	Program Name/Description	Input Data	Default	Level		
				1	2	3
24-01-03	<b>System Options for Hold – Exclusive Hold Recall Time</b> A call left on Exclusive Hold recalls the extension that placed it on Hold after this time.	0 ~ 64800 seconds	90		✓	
24-01-04	<b>System Options for Hold – Exclusive Hold Recall Callback Time</b> An Exclusive Hold Recall rings an extension for this time. If not picked up, the call goes back on System Hold.	0 ~ 64800 seconds	30		✓	
24-01-05	<b>System Options for Hold – Forced Release of Held Call</b> Depending on the setting of Program 14-01-16, the system disconnects calls on Hold longer than this time.	0 ~ 64800 seconds	1800		✓	
24-01-06	<b>System Options for Hold – Park Hold Time - Normal</b> Set the Park Hold Time. A call that is parked longer than the programmed time recalls the extension where it was initially parked. Refer to <a href="#">Flexible System Numbering on page 2-545</a> for setting Flexible Timeouts for Class of Service.	0 ~ 64800 seconds	90		✓	
24-01-07	<b>System Options for Hold – Park Hold Time - Extended (Recall)</b> Set the Extended Park Hold Time. A call that is parked longer than the programmed time recalls the extension where it was initially parked.	0 ~ 64800 seconds	300		✓	

## Operation

### To place an outgoing call on hold and retrieve it using a multiline terminal:

1. Go off-hook using the handset and wait for internal dial tone.  
- OR -  
Press **Speaker** and wait for internal dial tone.
2. Dial the Trunk Access Code (default: **9**).
3. Dial the outside party (the Call Appearance key lights). Begin your conversation.
4. Press **Hold** (the Call Appearance key flashes).
5. Press the flashing **Call Appearance** key to retrieve the call.

**To receive an incoming call, put it on hold and then retrieve it using a multiline terminal:**

1. Receive CO/PBX incoming ring.
2. Go off-hook using the handset, or press **Speaker** (the Call Appearance key lights). Talk with outside party.
3. Press **Hold** (the Call Appearance key flashes).
4. Press the flashing **Call Appearance** key to retrieve the call.

## Call Arrival (CAR) Keys

### Description

Call Arrival (CAR) Keys are software extensions available on the Basic and Expanded Port Packages. A Call Arrival Extension assigned to a line key, can appear and ring on an individual station or multiple stations. Call Arrival Keys are busy only when ringing and are not used during talking.

Call Arrival Keys are shared with the Virtual Extensions (VE). In virtual extension mode, the key acts as a secondary extension. Up to 512 CAR/VE keys are provided.

### Conditions

- CAR keys and virtual extensions share 512 available ports/extensions.
- The 512 available ports/extensions are assigned per extension for CAR key mode or virtual extension (VE) key mode.
- More than one extension can share a CAR key.
- An extension can have more than one CAR key assigned.
- Up to 32 incoming calls can be queued to busy CAR key.
- If multiple CAR/SIE/VE keys are ringing on a station at the same time, the CAR/SIE/VE key on the lowest Line Key is answered first.
- The system can be programmed to blink the page number of a DT300/DT700 DESI-Less terminal when it receives an incoming call, or switch to the page of the incoming call. Also, a default page can be defined for the DESI-Less terminal to change to when it goes idle or when it has answered a call.
- DESI-Less screen page switching only applies to idle terminals. If a terminal is not idle, the screen will not switch if another call comes in until the phone goes idle.

### Default Settings

None

### System Availability

#### Terminals

All Multiline Terminals

## Required Component(s)

None

## Related Features

➔ **Video Conference with Web RTC**

## Guide to Feature Programming

The **Level 1**, **Level 2** and **Level 3** columns indicate the programs that are assigned when programming this feature in the order they are most commonly used. These levels are used with PCPro and WebPro wizards for feature programming.

- Level 1 – these are the most commonly assigned programs for this feature.
- Level 2 – these are the next most commonly assigned programs for this feature.
- Level 3 – these programs are not often assigned and require an expert level working knowledge of the system to be properly assigned.

Program Number	Program Name/Description	Input Data	Default	Level		
				1	2	3
11-01-01	<b>System Numbering – Service Code</b> Set system numbering plan.	Set the system internal (Intercom) numbering plan. The numbering plan assigns the first and second digits dialed and affects the digits an extension user must dial to access other extensions and features, such as service codes and trunk codes. If the default numbering plan does not meet the site requirements, use this program to tailor the system numbering to the site.	Refer to the Programming Manual for default values.	✓		
11-04-01	<b>Virtual Extension Numbering</b> Assign virtual extension numbers.	Dial (maximum of eight digits)	Virtual Extension Port No. 1 ~ 99 = Virtual Extension Number 201 ~ 299 Virtual Extension Port No. 100 ~ 512 = No Setting	✓		
15-01-01	<b>Basic Extension Data Setup – Extension Name</b> Define the extension/virtual extension name.	Maximum of 12 characters	STA 101 = Ext 101 STA 102 = Ext 102, etc.		✓	

Program Number	Program Name/Description	Input Data	Default	Level		
				1	2	3
15-01-05	<b>Basic Extension Data Setup – Restriction for Outgoing Disable on Incoming Line</b> Enable (1)/Disable (0) supervised dial detection for an extension.	0 = No 1 = Yes	0			✓
15-02-07	<b>Multiline Telephone Basic Data Setup – Automatic Hold for CO Lines</b> Assign automatic hold (or disconnect) for CO lines.	0 = Hold 1 = Disconnect (Cut)	1			✓
15-02-21	<b>Multiline Telephone Basic Data Setup – Virtual Extension Access Mode (when idle Virtual Extension key pressed)</b> Determine whether a Virtual Extension/Call Arrival Key (CAR) should function as a DSS key, a Virtual Extension, or a CAR key. When DSS (0) is selected, the key functions as a DSS key to the extension and for incoming calls to that extension. When Outgoing (1) is selected, the key functions as a virtual extension and can be used for incoming and outgoing calls. When Ignore (2) is selected, the key functions as a CAR key and can receive incoming calls only.	Virtual Extension Key Mode 0 = DSS 1 = Outgoing 2 = Ignore	2		✓	
15-07-01	<b>Programmable Function Keys</b> Assign functions to multiline terminal line keys.	Line Key 1 ~ 48 0 ~ 99 (Normal Function Code 751 by default) *00 ~ *99 (Appearance Function Code) (Service Code 752 by default) (*03 + ICM = VE or CAR where ICM is the extension number of the VE or CAR)	Refer to the Programming Manual for default values.	✓		
15-08-01	<b>Incoming Virtual Extension Ring Tone Setup</b> When an extension or a virtual extension is assigned to the function key on the key telephone, select the ring tone when receiving a call on that key. For Contact Center CAR keys, only tone pattern 1 (entry 0) can be used. The remaining patterns are not checked with this feature.	0 = Tone Pattern 1 1 = Tone Pattern 2 2 = Tone Pattern 3 3 = Tone Pattern 4 4 = Incoming Ring Tone Extension 5 = Tone Pattern 5 6 = Tone Pattern 6 7 = Tone Pattern 7 8 = Tone Pattern 8	0 = Tone Pattern 1		✓	
15-09-01	<b>Virtual Extension Ring Assignment</b> Assign the ringing options for an extension Virtual Extension Key or Virtual Extension Group Answer Key which is defined in Program 15-07.	Day Night/Mode: 1 ~ 8 Ringing: 0 = No Ringing 1 = Ring	0	✓		

Program Number	Program Name/Description	Input Data	Default	Level		
				1	2	3
15-10-01	<b>Incoming Virtual Extension Ring Tone Order Setup</b> When two or more virtual extensions are set on a function key on the telephone, and the tone pattern by which the sound of each extension differs, the priority of ring sound is set up.	0 = Tone Pattern 1 1 = Tone Pattern 2 2 = Tone Pattern 3 3 = Tone Pattern 4 4 = Incoming Extension Ring Tone 5 = Tone Pattern 5 6 = Tone Pattern 6 7 = Tone Pattern 7 8 = Tone Pattern 8	Order 1 Pattern 0 = Pattern 1 Order 2 Pattern 1 = Pattern 2 Order 3 Pattern 2 = Pattern 3 Order 4 Pattern 3 = Pattern 4		✓	
15-11-01	<b>Virtual Extension Delayed Ring Assignment</b> Assign the delayed ringing options for an extension Virtual Extension or Virtual Extension Group Answer keys (defined in Program 15-09).	Day Night/Mode: 1 ~ 8 Ringing: 0 = Immediate Ring 1 = Delayed Ring	0		✓	
15-18-01	<b>Virtual Extension Key Enhanced Options – Virtual Extension Key Operation Mode</b> Define whether calls to a Virtual Extension Key land on the Virtual or on the extension / CAP / CO appearance. ➡ <i>This is assigned for the Virtual Extension Key not the extension it resides on.</i>	0 = Release 1 = Land on the key	0		✓	
15-18-02	<b>Virtual Extension Key Enhanced Options – Display Mode When Placing a Call on Virtual Extension Key</b> Define if calls to or from a Virtual Extension Key display the Virtual Extension Key name or the name of the extension it resides on.	0 = Secondary Extension Name 1 = Actual Station Name	0		✓	
20-04-03	<b>System Options for Virtual Extensions – CAR/SIE/Virtual Extension Delay Interval</b> CAR Keys/SIE Keys/Virtual Extensions set for Delayed Ringing (see Program 15-11) ring the extension after this time.	0 ~ 64800 seconds	10		✓	
20-06-01	<b>Class of Service for Extensions</b> Assign a Class of Service (1 ~ 15) to extensions.	Day Night/Mode: 1 ~ 8 Class of Service of Extensions (1 ~ 15)	Extension port 101 = Class 15 All other extension port = Class 1	✓		
20-07-10	<b>Class of Service Options (Administrator Level) – Programmable Function Key Programming (Appearance Level)</b> Turn Off or On an extension user ability to program the Appearance function keys using Service Code 752.	0 = Off 1 = On	COS 1 ~ 15 = 1		✓	



Program Number	Program Name/Description	Input Data	Default	Level		
				1	2	3
20-10-08	<b>Class of Service Options (Answer Service) – Virtual Extension Off-Hook Answer</b> Turn Off or On an extension ability to answer an incoming call on a Call Arrival (CAR)/ Secondary Incoming Extension (SIE)/ Virtual Extension simply by lifting the handset.	0 = Off 1 = On	COS 1 ~ 15 = 1		✓	
20-13-27	<b>Class of Service Options (Supplementary Service) – Busy on Seizing Virtual Extension</b> If set to 1, a busy extension can be called, while someone is talking on a virtual extension key. Program 20-13-06 (Call Waiting) must be set to off for this option to work.	0 = Off 1 = On	COS 1 ~ 15 = 1			✓
21-01-15	<b>System Options for Outgoing Calls – Outgoing Disable on Incoming Line (Toll Restriction)</b> Enable/Disable the Outgoing Disable on Incoming Line feature.	0 = Disable (Off) 1 = Enable (On)	0			✓
23-04-01	<b>Ringling Line Preference for Virtual Extensions</b> When an extension has a virtual extension assigned to a Programmable Function Key, program this option to determine the priority for automatically answering the ringing calls when the handset is lifted. If 0 or 00 is selected, when the user lifts the handset, the user answers a ringing call from any group.	0 ~ 64 (0 or 00 = Don't Care)	00		✓	

## Operation

### To answer a call ringing a Call Arrival (CAR) Key:

1. Press the flashing Call Arrival (CAR) Key.

### To place a call to a Call Arrival (CAR) Key:

1. Lift the handset, or press **Speaker**.
2. Dial the CAR key extension, or press the Call Arrival (CAR) Key.  
◇ *The operation depends on the setting in Program 15-02-21.*

### To program a Call Arrival (CAR) Key on a telephone:

1. Press **Speaker**.
2. Dial **752**.
3. Press the key you want to program.
4. Dial **\*03**.

5. Dial the number of the extension you want to appear on the key.
6. Press **Hold** once for Immediate Ring
  - ◇ *To set for Delayed Ring, skip to Step 8.*
7. Dial the Mode number in which the key rings.

1 = Day 1	5 = Day 2
2 = Night 1	6 = Night 2
3 = Midnight 1	7 = Midnight 2
4 = Rest 1	8 = Rest 2
8. Press **Hold** to set up Delayed Ring.
  - OR -
  - Skip to Step 10.
9. Dial the mode number in which the key delay rings.

1 = Day 1	5 = Day 2
2 = Night 1	6 = Night 2
3 = Midnight 1	7 = Midnight 2
4 = Rest 1	8 = Rest 2
10. Press **Speaker**.

## Call Duration Timer

### Description

Call Duration Timer lets a multiline terminal with an LCD time their trunk calls on the telephone display. This helps users that must keep track of their time on the telephone. For incoming trunk calls, the Call Time begins as soon as the user answers the call.

#### Conditions

- The Call Timer starts over each time the call is retrieved from Hold or Park.
- The Call Duration Timer (Program 20-13-36) is not displayed for inbound Contact Center calls.

#### Default Settings

Enabled

### System Availability

#### Terminals

All Multiline Terminals with Display

#### Required Component(s)

None

### Related Features

↳ [Alphanumeric Display](#)

## Guide to Feature Programming

The **Level 1**, **Level 2** and **Level 3** columns indicate the programs that are assigned when programming this feature in the order they are most commonly used. These levels are used with PCPro and WebPro wizards for feature programming.

- Level 1 – these are the most commonly assigned programs for this feature.
- Level 2 – these are the next most commonly assigned programs for this feature.
- Level 3 – these programs are not often assigned and require an expert level working knowledge of the system to be properly assigned.

Program Number	Program Name/Description	Input Data	Default	Level		
				1	2	3
20-06-01	<b>Class of Service for Extensions</b> Assign a Class of Service (1 ~ 15) to extensions.	Day Night/Mode: 1 ~ 8 Class of Service of Extensions (1 ~ 15)	Extension port 101 = Class 15 All other extension port = Class 1	✓		
20-09-06	<b>Class of Service Options (Incoming Call Service) – Incoming Time Display</b> If this option is set to 1, the Incoming Call Time is displayed on the multiline terminals LCD while the telephone is ringing. ➡ <i>Caller ID should be enabled for this feature in Program 20-09-06 to function.</i>	0 = Off 1 = On	COS 1 ~ 15 = 0	✓		
20-13-36	<b>Class of Service Options (Supplementary Service) – Call Duration Timer Display</b> Turn Off or On a Call Timer for the extension.	0 = Off 1 = On	COS 1 ~ 15 = 1	✓		
21-01-03	<b>System Options for Outgoing calls – Trunk Interdigit Time (External)</b> The system waits for this time to expire before starting the Call Timer.	0 ~ 64800 seconds	5	✓		

## Operation

### To time your trunk calls:

1. Place a trunk call.
  - ◇ *The timer starts automatically.*

## Call Forwarding

### Description

Call Forwarding permits an extension user to redirect their calls to another extension or an off-premise number. Call Forwarding ensures that the user's calls are covered when they are away from their work area. The types of Call Forwarding are:

- Call Forwarding when Busy or Unanswered  
Calls to the extension forward when busy or unanswered.
- Call Forwarding – Centrex  
When using PBX/Centrex trunks, calls to the extension perform a Centrex transfer using Immediate, Busy and No Answer Forwarding.
- Call Forwarding Immediate  
All calls forward immediately to the destination, and only the destination rings.
- Call Forwarding with both Ringing  
All calls forward immediately to the destination, and both the destination and the forwarded extension ring (not for Voice Mail).
- Call Forwarding when Unanswered  
Calls forward only if they are unanswered (Ring No Answer).
- Call Forwarding Follow Me  
Refer to [Call Forwarding with Follow Me on page 2-167](#) for more information.
- Live Monitor  
Allows the extension to emulate an answering machine. Refer to InMail System Guide for more information.

Call Forwarding reroutes calls ringing an extension, including calls transferred from another extension. Call Forwarding can also be split, allowing internal and external calls to forward to different destinations. The extension user can enable Call Forwarding from their telephone. An extension user can also set the forwarding for another extension by using Call Forward for any Extension to Destination. To redirect calls while a user is at another telephone, use Call Forwarding with Follow Me. A periodic VRS announcement can remind users that their calls are forwarded.

### Conditions

- Virtual Extensions can be set to Call Forward. Program 15-02-21 must be set to a 1 to allow the Virtual Extension to place outgoing calls.
- If an extension in a call forward chain has Call Forward with Both Ring, calls do not continue routing to other extensions in the chain.
- If an extension in a call forward chain has Call Forward with Follow Me set, calls do not continue routing to other extensions in the chain.

- If the extension has Call Forward-Both Ring set to another extension, it will only continue to forward if the *Both* ring location is forwarded (B/NA or NA) to VM and no where else.
- Call Forwards can be chained allowing calls to forward from one extension to the next. Up to 32 extensions can be linked in a call forward chain.
- Call Forwarding an extension in a Department Group prevents that extension from receiving Department Pilot Calls.
- Ring Groups do not follow Call Forwarding.
- Call Forward Split does not allow for Call Forward with Follow Me.
- If Call Forwarding off premise, a trunk access code must be included in the forwarding number.
- Call Forward with Follow Me allows for a single station to set follow me for multiple stations. When canceling Call Forward with Follow Me, the use must specify the station to cancel or cancel all.
- The telephone must be idle to enable call forwarding with a Programmable Function Key, or receiving dial tone to enable call forwarding with a service code.
- Call Forward for any Extension to Destination cannot be set or canceled from a Virtual Extension.
- Call Forwarding/Do Not Disturb Override allows for Overriding a Call Forwarding or DND setting at another extension.
- When a call is transferred because of Call Forwarding No Answer, Call Forwarding Busy, or DND, the Reason for Transfer option can display to the transferred extension why the call is ringing their telephone.
- An extension user can forward their calls to a Department number.
- A DSS key indicates a Call Forwarding indication for extensions.
- When DND All and Call Forward are set on the same telephone, call forwarding works. If Busy and No Answer Forwarding are set to different locations, it follows the Busy forwarding.
- Function keys simplify Call Forwarding operation.
- If an extension Class of Service denies Call Forwarding (Program 20-11-01~Program 20-11-05, off), the extension can still dial the service code to Set/Cancel Call Forwarding, but it cannot set any data.
- Call Forward Both Ring Split does not work to an off-premise destination.
- If an IP telephone has forwarding set and then loses connection, it follows the forwarding.
- If an IP phone has Busy and No Answer Forwarding set to different locations and it loses connection, it follows the Busy forwarding location.
- For calls to queue to that virtual extension, Call Forward No Answer must be used.

- When the following are done in sequence,
  - Call Forwarding Busy/No Answer is set to extension
  - Call Forwarding Immediate is set on extension
  - Call Forwarding Immediate is cancelled on extensionthen,  
Call Forwarding Busy/No Answer is set back on the extension.
- When the following are done in sequence,
  - Call Forwarding No Answer is set to extension
  - Call Forwarding Immediate is set on extension
  - Call Forwarding Immediate is cancelled on extensionthen,  
all Call Forwarding is cancelled.
  - ◇ *Any settings in Programs 24-09-04 and 24-09-05, copies the information to Programs 24-09-02 and 24-09-03 and is changed to Call Forwarding Busy/No Answer.*
- When the following are done in sequence,
  - Call Forwarding Busy is set to extension
  - Call Forwarding Immediate is set on extension
  - Call Forwarding Immediate is cancelled on extensionthen,  
Call Forwarding Busy/No Answer is set back on the extension.
- The **@** and **P** characters are not supported in the call forward destination. These characters are only supported on a one touch/DSS key and in speed dial bins.
- If the terminal is configured for Call Forward Both Ring and DND is activated, the calling station will receive a busy tone. Call Forward Both Ring is not followed.
- If Program 20-11-30 is set to **0** (Off), the Call FWD setting is displayed on the terminal LCD screen when idle.
- Call Forwarding for a Virtual Extension cannot be set from DISA.

## Default Settings

Enabled

## System Availability

### Terminals

All Terminals and Virtual Extensions

### Required Component(s)

None

## Related Features

- ↳ **Call Forwarding with Follow Me**
- ↳ **Call Forwarding, Off-Premise**
- ↳ **Call Forwarding/Do Not Disturb Override**
- ↳ **Central Office Calls, Answering**
- ↳ **Department Calling**
- ↳ **Direct Station Selection (DSS) Console**
- ↳ **Do Not Disturb**
- ↳ **Programmable Function Keys**
- ↳ **Voice Response System (VRS)**

## Guide to Feature Programming

The **Level 1**, **Level 2** and **Level 3** columns indicate the programs that are assigned when programming this feature in the order they are most commonly used. These levels are used with PCPro and WebPro wizards for feature programming.

- Level 1 – these are the most commonly assigned programs for this feature.
- Level 2 – these are the next most commonly assigned programs for this feature.
- Level 3 – these programs are not often assigned and require an expert level working knowledge of the system to be properly assigned.



Program Number	Program Name/Description	Input Data	Default	Level		
				1	2	3
11-10-06	<b>Service Code Setup (for System Administrator) – Setting the Automatic Transfer for Each Trunk Line</b> Set the service code for setting automatic transfer for each trunk line.	MLT 0 ~ 9, *, # Maximum of eight digits	733		✓	
11-10-07	<b>Service Code Setup (for System Administrator) – Canceling the Automatic Transfer for Each Trunk Line</b> Set the service code for canceling automatic transfer for each trunk line.	MLT 0 ~ 9, *, # Maximum of eight digits	734		✓	
11-10-08	<b>Service Code Setup (for System Administrator) – Setting the Destination for Automatic Trunk Transfer</b> Set the service code for setting the destination for automatic trunk transfer.	MLT 0 ~ 9, *, # Maximum of eight digits	735		✓	
11-10-18	<b>Service Code Setup (for System Administrator) – Off-Premise Call Forward by Door Box</b> Set the service code for setting automatic transfer for each trunk line.	MLT 0 ~ 9, *, # Maximum of eight digits	722		✓	
11-11-01	<b>Service Code Setup (for Setup/Entry Operation) – Call Forward – All</b> Set the service code for setting call forwarding all calls.	MLT, SLT 0 ~ 9, *, # Maximum of eight digits	741		✓	
11-11-02	<b>Service Code Setup (for Setup/Entry Operation) – Call Forward – Busy</b> Set the service code for setting call forwarding for busy calls.	MLT, SLT 0 ~ 9, *, # Maximum of eight digits	742		✓	
11-11-03	<b>Service Code Setup (for Setup/Entry Operation) – Call Forward – No Answer</b> Set the service code for setting call forwarding for no answer.	MLT, SLT 0 ~ 9, *, # Maximum of eight digits	743		✓	
11-11-04	<b>Service Code Setup (for Setup/Entry Operation) – Call Forward – Busy/No Answer</b> Set the service code for setting call forwarding for busy or no answer.	MLT, SLT 0 ~ 9, *, # Maximum of eight digits	744		✓	
11-11-05	<b>Service Code Setup (for Setup/Entry Operation) – Call Forward – Both Ring</b> Set the service code for setting call forwarding for busy or no answer.	MLT, SLT 0 ~ 9, *, # Maximum of eight digits	745		✓	
11-11-07	<b>Service Code Setup (for Setup/Entry Operation) – Call Forwarding – Follow Me</b> Set the service code for setting call forwarding for follow me.	MLT, SLT 0 ~ 9, *, # Maximum of eight digits	746		✓	

Program Number	Program Name/Description	Input Data	Default	Level		
				1	2	3
11-11-08	<b>Service Code Setup (for Setup/Entry Operation) – Do Not Disturb</b> Set the service code for setting call forwarding for Do Not Disturb.	MLT, SLT 0 ~ 9, *, # Maximum of eight digits	747		✓	
11-11-45	<b>Service Code Setup (for Setup/Entry Operation) – Set/Cancel Call Forward All (Split)</b> Set or Cancel the call forward all split.	MLT, SLT 0 ~ 9, *, # Maximum of eight digits	No Setting		✓	
11-11-46	<b>Service Code Setup (for Setup/Entry Operation) – Set/Cancel Call Forward Busy (Split)</b> Set or Cancel the call forward busy split.	MLT, SLT 0 ~ 9, *, # Maximum of eight digits	No Setting		✓	
11-11-47	<b>Service Code Setup (for Setup/Entry Operation) – Set/Cancel Call Forward No Answer (Split)</b> Set or Cancel the call forward no answer split.	MLT, SLT 0 ~ 9, *, # Maximum of eight digits	No Setting		✓	
11-11-48	<b>Service Code Setup (for Setup/Entry Operation) – Set/Cancel Call Forward Busy/ No Answer (Split)</b> Set or Cancel the call forward busy or no answer split.	MLT, SLT 0 ~ 9, *, # Maximum of eight digits	No Setting		✓	
11-11-49	<b>Service Code Setup (for Setup/Entry Operation) – Set/Cancel Call Forward Both Ring (Split)</b> Set or Cancel the call forward the both ring split.	MLT, SLT 0 ~ 9, *, # Maximum of eight digits	No Setting		✓	
11-11-52	<b>Service Code Setup (for Setup/Entry Operation) – Set/Cancel Call Forward All Destination (No Split)</b> Set or Cancel the call forward all destination with no split.	MLT, SLT 0 ~ 9, *, # Maximum of eight digits	790		✓	
11-11-53	<b>Service Code Setup (for Setup/Entry Operation) – Set/Cancel Call Forward Busy Destination (No Split)</b> Set or Cancel the call forward busy destination with no split.	MLT, SLT 0 ~ 9, *, # Maximum of eight digits	791		✓	
11-11-54	<b>Service Code Setup (for Setup/Entry Operation) – Set/Cancel Call Forward No Answer Destination (No Split)</b> Set or Cancel the call forward no answer destination with no split.	MLT, SLT 0 ~ 9, *, # Maximum of eight digits	792		✓	
11-11-55	<b>Service Code Setup (for Setup/Entry Operation) – Call Forward Busy No Answer Destination (No Split)</b> Set or Cancel the call forward busy or no answer destination with no split.	MLT, SLT 0 ~ 9, *, # Maximum of eight digits	793		✓	

Program Number	Program Name/Description	Input Data	Default	Level		
				1	2	3
11-11-58	<b>Service Code Setup (for Setup/Entry Operation) – Call forward with Personal Greeting</b> Set the service code for setting call forwarding with Personal Greeting.	MLT, SLT 0 ~ 9, *, # Maximum of eight digits	713		✓	
11-12-01	<b>Service Code Setup (for Service Access) – Bypass Call</b> Customize the Service Codes which are used for bypass calls.	MLT, SLT 0 ~ 9, *, # Maximum of eight digits	707		✓	
11-16-06	<b>Single Digit Service Code Setup – DND/Call Forward Override Bypass</b> Customize the one-digit Service Codes used when a busy or ring back signal is heard.	0 ~ 9, *, # Maximum of one digit	No Setting		✓	
15-07-01	<b>Programmable Function Keys</b> Assign functions to multiline terminal line keys.	Line Key 1 ~ 48 0 ~ 99 (Normal Function Code 751 by default) *00 ~ *99 (Appearance Function Code) (Service Code 752 by default)	Refer to the Programming Manual for default values.	✓		
20-06-01	<b>Class of Service for Extensions</b> Assign a Class of Service (1 ~ 15) to extensions.	Day Night/Mode: 1 ~ 8 Class of Service of Extensions (1 ~ 15)	Extension port 101 = Class 15 All other extension port = Class 1	✓		
20-09-01	<b>Class of Service Options (Incoming Call Service) – Second Call for DID/DISA/DIL/ E&amp;M Override</b> Turn Off or On an extension ability to receive a second call from a DID, DISA, DIL, or tie line caller.  ➡ <i>With this option set to 1, the destination extension must be busy for a second DNIS caller to ring through. If the destination extension does not have a trunk or CAP key available for the second call and a previous call is ringing the extension but has not yet been answered, the second caller hears busy regardless of this program setting.</i>	0 = Off 1 = On	COS 1 ~15 = 1		✓	
20-09-07	<b>Class of Service Options (Incoming Call Service) – Call Queuing</b> Turn Off or On an extension ability to have calls queued if a call rings the extension when it is busy.  ➡ <i>Program 20-13-06 must be set to 0 (Off) for this feature to work.</i>	0 = Off 1 = On	COS 1 ~ 15 = 1		✓	
20-11-01	<b>Class of Service Options (Hold/Transfer Service) – Call Forward All</b> Turn Off or On an extension user ability to set Call Forward Immediate.	0 = Off 1 = On	COS 1 ~ 15 = 1	✓		

Program Number	Program Name/Description	Input Data	Default	Level		
				1	2	3
20-11-02	<b>Class of Service Options (Hold/Transfer Service) – Call Forward When Busy</b> Turn Off or On an extension user ability to set Call Forwarding when Busy.	0 = Off 1 = On	COS 1 ~ 15 = 1	✓		
20-11-03	<b>Class of Service Options (Hold/Transfer Service) – Call Forwarding When Unanswered</b> Turn Off or On an extension user ability to set Call Forwarding when Unanswered.	0 = Off 1 = On	COS 1 ~ 15 = 1	✓		
20-11-04	<b>Class of Service Options (Hold/Transfer Service) – Call Forwarding (Both Ringing)</b> Turn Off or On an extension user ability to set Call Forwarding with Both Ringing.	0 = Off 1 = On	COS 1 ~ 15 = 1	✓		
20-11-05	<b>Class of Service Options (Hold/Transfer Service) – Call Forwarding with Follow Me</b> Turn Off or On an extension user ability to set Call Forward with Follow Me.	0 = Off 1 = On	COS 1 ~ 15 = 1	✓		
20-11-23	<b>Class of Service Options (Hold/Transfer Service) – CAR/VE Call Forward Set/Cancel</b> Turn Off or On the ability to set and cancel Call Forwarding for a CAR or Virtual Extension.	0 = Off 1 = On	COS 1 ~ 15 = 1	✓		
20-11-30	<b>Class of Service Options (Hold/Transfer Service) – Disable Call FWD Indication on LCD</b> When set to On (1), Call FWD setting is not shown on the terminal LCD.	0 = Off 1 = On	1		✓	
20-13-05	<b>Class of Service Options (Supplementary Service) – Intercom Off-Hook Signaling</b> Turn Off or On an extension to send off-hook Signals. ➤ <i>This setting functions with Programs 20-09-07 and 20-13-06 disabled.</i>	0 = Off 1 = On	COS 1 ~ 15 = 1		✓	
20-13-06	<b>Class of Service Options (Supplementary Service) – Automatic Off-Hook Signaling (Automatic Override)</b> Allow a busy extension user to manually (0) or automatically (1) receive off-hook signals. An example of an off-hook signal is the tone heard when receiving a second call. ➤ <i>This setting is to receive incoming call signaling information during call queuing.</i>	0 = Off 1 = On	COS 1 ~ 15 = 1		✓	
24-02-03	<b>System Options for Transfer – Delayed Call Forwarding Time</b> Set the Delayed Call Forwarding interval. For an unanswered call, Call Forward No Answer occurs after this interval.	0 ~ 64800 seconds	10	✓		

Program Number	Program Name/Description	Input Data	Default	Level		
				1	2	3
24-09-01	<b>Call Forward Split Settings – Call Forwarding Type:</b> Assign Call Forwarding Type and the destination numbers for each extension/virtual extension.	0 = No Call Forwarding 1 = Call Forward Both 2 = Call Forward No Answer 3 = Call Forward All 4 = Call Forward Busy No Answer 5 = Call Forward Busy	0		✓	
24-09-02	<b>Call Forward Split Settings – CO Call Forwarding Destination for Both Ring, All Call, No Answer</b> Assign CO Call Forwarding Destination for ring, all call and no answer.	Maximum of 24 digits (0 ~ 9, *, #, @, P, R) @ = Wait for Answer Supervision - ISDN trunks only P = Pause - Analog Trunk Only R = Hook flash - Analog Trunk Only	No Setting		✓	
24-09-03	<b>Call Forward Split Settings – Intercom Call Forwarding Destination for Both ring, All Call, No Answer</b> Assign Intercom Call Forwarding Destination for ring, all call and no answer.	Maximum of 24 digits (0 ~ 9, *, #, @, P, R) @ = Wait for Answer Supervision - ISDN trunks only P = Pause - Analog Trunk Only R = Hook flash - Analog Trunk Only	No Setting		✓	
24-09-04	<b>Call Forward Split Settings – CO Call Forwarding Busy Destination</b> Assign CO Call Forwarding for busy destinations.	Maximum of 24 digits (0 ~ 9, *, #, @, P, R) @ = Wait for Answer Supervision - ISDN trunks only P = Pause - Analog Trunk Only R = Hook flash - Analog Trunk Only	No Setting		✓	
24-09-05	<b>Call Forward Split Settings – Intercom Call Forwarding Busy Destination</b> Assign Intercom Call Forwarding for busy destinations.	Maximum of 24 digits (0 ~ 9, *, #, @, P, R) @ = Wait for Answer Supervision - ISDN trunks only P = Pause - Analog Trunk Only R = Hook flash - Analog Trunk Only	No Setting		✓	
24-09-06	<b>Call Forward Split Settings – Call Forwarding Destination for CTX/PBX for All Call, No Answer</b> Assign Call Forwarding for CTX/PBX all call, no answer destinations.	Maximum of 24 digits (0 ~ 9, *, #, @, P, R) @ = Wait for Answer Supervision - ISDN trunks only P = Pause - Analog Trunk Only R = Hook flash - Analog Trunk Only	No Setting		✓	
24-09-07	<b>Call Forward Split Settings – Call Forwarding Destination for CTX/PBX for Busy</b> Assign Call Forwarding destinations for busy CTX/PBX calls.	Maximum of 24 digits (0 ~ 9, *, #, @, P, R) @ = Wait for Answer Supervision - ISDN trunks only P = Pause - Analog Trunk Only R = Hook flash - Analog Trunk Only	No Setting		✓	

## Operation

### To set Call Forward – Immediate at a forwarding station:

1. Pick up the handset or press **Speaker**.
2. Dial the Call Forward – Immediate Service Code (default: 741).

- OR -

At the multiline terminal only, press the **Call Forwarding Programmable Function Keys**.  
(Program 15-07-01, 10 or SC 751, Key Code 10)

3. Dial **1** (Set).
4. Dial the destination extension or off-premise number.
5. Press **Speaker** or hang up.
  - ◇ Refer to *Voice Response System (VRS) – Call Forwarding – Park and Page* on page 2-1861.
  - ◇ *The Call Forwarding Programmable Function Key lights.*

### To cancel Call Forward – Immediate at a forwarding station:

1. Pick up the handset or press **Speaker**.
2. Dial the Call Forward – Immediate Service Code (default: 741).

- OR -

At the multiline terminal only, press the **Call Forwarding Programmable Function keys**.  
(Program 15-07-01, 10 or SC 751, Key Code 10)

3. Dial **0** (Cancel).
4. Press **Speaker** or hang up.
  - ◇ *The Call Forwarding Programmable Function Key turns off.*

### To set Call Forward – Busy/No Answer at a forwarding station:

1. Pick up the handset or press **Speaker**.
2. Dial the Call Forward – Busy/No Answer Service Code (default: 744).

- OR -

At the multiline terminal only, press the **Call Forwarding Programmable Function keys**.  
(Program 15-07-01, 13 or SC 751, Key Code 13)

3. Dial **1** (Set).
4. Dial the destination extension or off-premise number.

5. Press **Speaker** or hang up.
  - ◇ Refer to *Voice Response System (VRS) – Call Forwarding – Park and Page on page 2-1861*.
  - ◇ *The Call Forwarding Programmable Function Key turns on.*

#### To cancel Call Forward – Busy/No Answer at a forwarding station:

1. Pick up the handset or press **Speaker**.
2. Dial the Call Forward – Busy/No Answer Service Code (default: 744).  
**- OR -**  
At the multiline terminal only, press the **Call Forwarding Programmable Function** keys.  
(Program 15-07-01, 13 or SC 751, Key Code 13)
3. Dial **0** (Cancel).
4. Press **Speaker** or hang up.
  - ◇ *The Call Forwarding Programmable Function Key turns off.*

#### To set Call Forward – Both Ring at a forwarding station:

1. Pick up the handset or press **Speaker**.
2. Dial the Call Forward – Both Ring Service Code (default: 745).  
**- OR -**  
At the multiline terminal only, press the **Call Forwarding Programmable Function** keys.  
(Program 15-07-01, 14 or SC 751, Key Code 14)
3. Dial **1** (Set).
4. Dial the destination extension number.
5. Press **Speaker** or hang up.
  - ◇ *The Call Forwarding Programmable Function Key turns on.*

#### To cancel Call Forward – Both Ring at a forwarding station:

1. Pick up the handset or press **Speaker**.
2. Dial the Call Forward – Both Ring Service Code (default: 745).  
**- OR -**  
At the multiline terminal only, press the **Call Forwarding Programmable Function** keys.  
(Program 15-07-01, 14 or SC 751 Key Code 14)
3. Dial **0** (Cancel).
4. Press **Speaker** or hang up.
  - ◇ *The Call Forwarding Programmable Function Key turns off.*

**To set Call Forward – Follow Me from the destination station:**

1. Pick up the handset or press **Speaker**.
2. Dial the Call Forward – Follow Me Service Code (default: 746).

- OR -

At the multiline terminal only, press the **Call Forwarding Programmable Function** keys.  
(Program 15-07-01, 10 or SC 751, Key Code 15)

3. Dial **1** (Set).
4. Dial the station number to be forwarded and then the destination number.
5. Press **Speaker** or hang up.
  - ◇ *The Call Forwarding Programmable Function Key goes on.*

**To cancel Call Forward – Follow Me from the destination station:**

1. Pick up the handset or press **Speaker**.
2. Dial the Call Forward – Follow Me Service Code (default: 746).

- OR -

At the multiline terminal only, press the **Call Forwarding Programmable Function** keys.  
(Program 15-07-01, 10 or SC 751, Key Code 15)

3. Dial **0** (Cancel).
4. Dial the station number, which is forwarded, or **0** to cancel all extensions.
5. Press **Speaker** or hang up.
  - ◇ *The Call Forwarding Programmable Function Key turns off.*

**To set Call Forward Immediate for any Extension to Destination:**

1. Pick up the handset or press **Speaker**.
2. Dial the Call Forward Immediate for any Extension to Destination Service Code (Default: 790).
3. Dial **1** (Set).
4. Dial the extension number to be forwarded and then the destination number.
5. Press **Speaker** or hang up.

**To cancel Call Forward Immediate for any Extension:**

1. Pick up the handset or press **Speaker**.
2. Dial the Call Forward Immediate for any Extension to Destination Service Code (default: 790).
3. Dial **0** (Cancel).
4. Dial the station number which is forwarded.



5. Press **Speaker** or hang up.

#### To set Call Forward Busy/No Answer for any Extension to Destination:

1. Pick up the handset or press **Speaker**.
2. Dial the Call Forward Busy/No Answer for any Extension to Destination Service Code (default: 793).
3. Dial **1** (Set).
4. Dial the extension number to be forwarded and then the destination number.
5. Press **Speaker** or hang up.

#### To cancel Call Forward Busy/No Answer for any Extension to Destination:

1. Pick up the handset or press **Speaker**.
2. Dial the Call Forward Busy/No Answer for any Extension to Destination Service Code (default: 793).
3. Dial **0** (Cancel).
4. Dial the station number, which is forwarded.
5. Press **Speaker** or hang up.

#### To set Call Forward – Immediate using a Virtual Extension:

1. Press the idle **Virtual Extension** key.
2. Dial the Call Forward – Immediate Service Code (default: 741).
3. Dial **1** (Set).
4. Dial the destination extension or off-premise number.
5. Press **Speaker** or hang up.  
◇ Refer to *Voice Response System (VRS) – Call Forwarding – Park and Page* on page 2-1861.

#### To cancel Call Forward – Immediate at a forwarding station:

1. Press the idle **Virtual Extension** key.
2. Dial the Call Forward – Immediate Service Code (default: 741).
3. Dial **0** (Cancel).
4. Press **Speaker** or hang up.

#### To set Call Forward – Busy/No Answer using a Virtual Extension:

1. Press the idle **Virtual Extension** key.
2. Dial the Call Forward – Busy/No Answer Service Code (Default: 744).

3. Dial **1** (Set).
4. Dial the destination extension or off-premise number.
5. Press **Speaker** or hang up.
  - ◇ Refer to *Voice Response System (VRS) – Call Forwarding – Park and Page* on page 2-1861.

**To cancel Call Forward – Busy/No Answer using a Virtual Extension:**

1. Press the idle **Virtual Extension** key.
2. Dial the Call Forward – Busy/No Answer Service Code (default: 744).
3. Dial **0** (Cancel).
4. Press **Speaker** or hang up.

## *Call Forwarding with Follow Me*

### Description

While at a co-worker's desk, a user can have Call Forwarding with Follow Me redirect their calls to the co-worker's extension. This helps an employee who gets detained at a co-worker's desk longer than expected. To prevent losing important calls, the employee can activate Call Forwarding with Follow Me from the co-worker's telephone.

Call Forwarding with Follow Me reroutes calls from the destination extension. To reroute calls from the initiating (forwarding) extension, use Call Forwarding.

### Conditions

- Call Forwarding an extension in a Department Group prevents that extension from receiving Department Pilot Calls.
- Multiple Stations can set Call Forward Follow Me to one station.
- Calls to extensions with DND active do not follow Call Forwarding programming. DIL calls ring an idle Department Group member, then follow Program 22-08 programming then Program 22-04 programming.
- Once Call Forwarding with Follow Me is activated on an extension, any Forwarding assigned in Program 24-09 for that extension or Follow Me destination is not followed.

### Default Settings

Enabled

### System Availability

#### Terminals

All Terminals

#### Required Component(s)

None

### Related Features

- ➔ **Do Not Disturb**
- ➔ **Programmable Function Keys**

## Guide to Feature Programming

The **Level 1**, **Level 2** and **Level 3** columns indicate the programs that are assigned when programming this feature in the order they are most commonly used. These levels are used with PCPro and WebPro wizards for feature programming.

- Level 1 – these are the most commonly assigned programs for this feature.
- Level 2 – these are the next most commonly assigned programs for this feature.
- Level 3 – these programs are not often assigned and require an expert level working knowledge of the system to be properly assigned.

Program Number	Program Name/Description	Input Data	Default	Level		
				1	2	3
11-11-07	<b>Service Code Setup (for Setup/Entry Operation) – Call Forwarding – Follow Me</b> Assign the service code of Call Forward Follow Me.	MLT, SLT 0 ~ 9, *, # Maximum of eight digits	746		✓	
15-07-01	<b>Programmable Function Keys</b> Assign functions to multiline terminal line keys.	Line Key 1 ~ 48 0 ~ 99 (Normal Function Code 751 by default) *00 ~ *99 (Appearance Function Code) (Service Code 752 by default)	Refer to the Programming Manual for default values.	✓		
20-06-01	<b>Class of Service for Extensions</b> Assign a Class of Service (1 ~ 15) to extensions.	Day Night/Mode: 1 ~ 8 Class of Service of Extensions (1 ~ 15)	Extension port 101 = Class 15 All other extension port = Class 1	✓		
20-11-05	<b>Class of Service Options (Hold/Transfer Service) – Call Forwarding with Follow Me</b> Turn Off or On an extension user ability to set Call Forward with Follow Me.	0 = Off 1 = On	COS 1 ~ 15 = 1	✓		

## Operation

### To activate Call Forward Follow Me from a multiline terminal:

1. At a multiline terminal, other than your own, press **Speaker** and dial Service Code (**746**, Program 11-11-07).  
  
- OR -  
Press the Call Forward Follow Me key (Program 15-07-01 or SC 751: Code 15).
2. Dial **1** to set.

3. Dial the Extension to forward.
  - ◇ *The multiline terminal with display indicates on the display of the telephone which Call Forward Follow Me is set. Also, the Programmed Follow Me Flexible Line Key flashes (if assigned) when Follow Me is set.*

#### To cancel Call Forward Follow Me from your own multiline terminal:

1. At your multiline terminal, press **Speaker** and dial Service Code (**746**, Program 11-11-07).
  - OR -
  - Press the Call Forward Follow Me key (Program 15-07-01 or SC 751: Code 15).
2. Dial **0** to cancel.
3. Dial **0** (Cancel All Forward Follow Me).
  - OR -
  - Dial the extension number with Follow Me set.

#### To activate Call Forward Follow Me from a single line telephone:

1. At a single line telephone, other than your own, lift the handset and dial the Service Code (**746** Program 11-11-07).
2. Dial **1** to set.
3. Dial the extension to forward.

#### To cancel Call Forward Follow Me from your own single line telephone:

1. At your single line telephone, lift the handset and dial Service Code (**746**, Program 11-11-07).
2. Dial **0** to cancel.
3. Dial **0** (Cancel All Forward Follow Me).
  - OR -
  - Dial the extension number with Follow Me set.

## Call Forwarding – Centrex

### Description

The Call Forwarding – Centrex feature allows a station to forward an incoming PBX/Centrex CO call to an outside location using the same PBX/Centrex CO line to free the line for additional use.

Call Forwarding – Centrex supports the following:

- Call Forward – Immediate
- Call Forward – Busy
- Call Forward – No Answer
- Call Forward – Busy/No Answer

### Conditions

- Call Forwarding – Centrex calls transferred from another station are forwarded when the transferred Trunk is assigned as PBX in Program 14-04-01.
- The following incoming calls follow Call Forwarding – Centrex when the incoming trunk is a PBX/Centrex trunk:
  - DIL
  - Station Transfer
  - Automated Attendant Transfer
  - DISA Calls
- Call Forwarding – Centrex is not supported for Call Forward Both Ring Split.
- A maximum of 24 digits can be assigned in the destination for Call Forwarding – Centrex.
- When a trunk is set to CTX/PBX, and is set for Call Forwarding – Centrex to an incorrect number, the call recalls and follow CO incoming ringing (i.e., DIL, Normal Ring Group Programming).
- When Call Forwarding – Centrex is set and all trunks are changed in Program 14-04-01 from PBX to Trunk, Call Forward is cleared from memory.
- When DND and any Call Forwarding – Centrex is set, the call forwards immediately.
- Call Forwarding – Centrex does not follow the Code Restriction of the stations.

### Default Settings

Disabled

## System Availability

### Terminals

All Terminals

### Required Component(s)

PBX/Centrex CO line

## Related Features

- ↳ **Call Arrival (CAR) Keys**
- ↳ **Call Forwarding**
- ↳ **Call Forwarding**
- ↳ **Direct Inward Dialing (DID)**
- ↳ **Door Box**
- ↳ **Do Not Disturb**
- ↳ **PBX Compatibility**
- ↳ **Video Conference with Web RTC**
- ↳ **Voice Response System (VRS)**

## Guide to Feature Programming

The **Level 1**, **Level 2** and **Level 3** columns indicate the programs that are assigned when programming this feature in the order they are most commonly used. These levels are used with PCPro and WebPro wizards for feature programming.

- Level 1 – these are the most commonly assigned programs for this feature.
- Level 2 – these are the next most commonly assigned programs for this feature.
- Level 3 – these programs are not often assigned and require an expert level working knowledge of the system to be properly assigned.

Program Number	Program Name/Description	Input Data	Default	Level		
				1	2	3
10-09-01	<b>DTMF and Dial Tone Circuit Setup</b> Allocate the circuits on the GCD-CP10 ETUs for either DTMF receiving or dial tone detection. Program 14-01-13 Basic Trunk Data Setup – Loop Supervision Enable (1) loop supervision for each trunk that should be able to use Call Forwarding – Centrex.	0 = Common Use 1 = Extension Only 2 = Trunk Only	Circuit/Resource 01 ~ 08 = 1 (Extensions) Circuit/Resource 09 ~ 32 = 2 (Trunks) Circuit/Resource 33 ~ 144 = 0 (Common) When GPZ-BS10 is installed, 81 ~ 144 are available		✓	
11-11-45	<b>Service Code Setup (for Setup/Entry Operation) – Set/Cancel Call Forward All (Split)</b> Assign the Call Forward All Split Service Code.	MLT, SLT 0 ~ 9, *, # Maximum of eight digits	No Setting		✓	
11-11-46	<b>Service Code Setup (for Setup/Entry Operation) – Set/Cancel Call Forward Busy (Split)</b> Assign the Call Forward Busy Split Service Code.	MLT, SLT 0 ~ 9, *, # Maximum of eight digits	No Setting		✓	
11-11-47	<b>Service Code Setup (for Setup/Entry Operation) – Set/Cancel Call Forward No Answer (Split)</b> Assign the Call Forward No Answer Split Service Code.	MLT, SLT 0 ~ 9, *, # Maximum of eight digits	No Setting		✓	
11-11-48	<b>Service Code Setup (for Setup/Entry Operation) – Set/Cancel Call Forward Busy/No Answer (Split)</b> Assign the Call Forward Busy No Answer Split Service Code.	MLT, SLT 0 ~ 9, *, # Maximum of eight digits	No Setting		✓	
14-01-13	<b>Basic Trunk Data Setup – Trunk-to-Trunk Transfer</b> Enable/Disable loop supervision for the trunk.	0 = Disable (No) 1 = Enable (Yes)	1	✓		
14-04-01	<b>Behind PBX Setup</b> Indicate if the trunk is installed behind a PBX (1) or not (0). There is one item for each Night Service Mode.	0 = Stand Alone (Trunk) 1 = Behind PBX (PBX) 2 = Not Used 3 = CTX assume 9	0	✓		



Program Number	Program Name/Description	Input Data	Default	Level		
				1	2	3
20-09-01	<p><b>Class of Service Options (Incoming Call Service) – Second Call for DID/DISA/DIL/ E&amp;M Override</b></p> <p>Turn Off or On an extension ability to receive a second call from a DID, DISA, DIL, or tie line caller.</p> <p>➤ <i>With this option set to 1, the destination extension must be busy for a second DNIS caller to ring through. If the destination extension does not have a trunk or CAP key available for the second call and a previous call is ringing the extension but has not yet been answered, the second caller hears busy regardless of this program setting.</i></p>	<p>0 = Off 1 = On</p>	COS 1 ~ 15 = 1	✓		
20-09-07	<p><b>Class of Service Options (Incoming Call Service) – Call Queuing</b></p> <p>Turn Off or On an extension ability to have calls queued if a call rings the extension when it is busy.</p> <p>➤ <i>Program 20-13-06 must be set to 0 (Off) for this feature to work.</i></p>	<p>0 = Off 1 = On</p>	COS 1 ~ 15 = 1	✓		
20-13-05	<p><b>Class of Service Options (Supplementary Service) – Intercom Off-Hook Signaling</b></p> <p>Turn Off or On an extension ability to send off-hook signals.</p> <p>➤ <i>This setting functions with Programs 20-09-07 and 20-13-06 disabled.</i></p>	<p>0 = Off 1 = On</p>	COS 1 ~ 15 = 1	✓		
20-13-06	<p><b>Class of Service Options (Supplementary Service) – Automatic Off-Hook Signaling (Automatic Override)</b></p> <p>Allow a busy extension user to Manually (0) or Automatically (1) receive off-hook signals.</p> <p>➤ <i>This setting is to receive incoming call signaling information during call queuing.</i></p>	<p>0 = Off 1 = On</p>	COS 1 ~ 15 = 1	✓		
24-02-13	<p><b>System Options for Transfer – Hook Flash Sending Timer When the System Answers Automatically</b></p> <p>Set the time the system waits before sending the hookflash for the Centrex Transfer after answering the call.</p>	0 ~ 64800 seconds	2		✓	
24-09-06	<p><b>Call Forward Split Settings – Call Forwarding Destination for CTX/PBX for All Call, No Answer</b></p> <p>Assign Call Forwarding Type and the destination numbers for CTX/PBX all call, no answer.</p>	<p>Maximum of 24 digits (0 ~ 9, *, #, @, P, R) @ = Wait for Answer Supervision - ISDN trunks only P = Pause - Analog Trunk Only R = Hook flash - Analog Trunk Only</p>	No Setting	✓		

Program Number	Program Name/Description	Input Data	Default	Level		
				1	2	3
24-09-07	<b>Call Forward Split Settings – Call Forwarding Destination for CTX/PBX for Busy</b> Assign Call Forwarding Type and the destination numbers for CTX/PBX busy calls.	Maximum of 24 digits (0 ~ 9, *, #, @, P, R) @ = Wait for Answer Supervision - ISDN trunks only P = Pause - Analog Trunk Only R = Hook flash - Analog Trunk Only	No Setting	✓		

## Operation

### To activate Call Forwarding – Centrex:

1. At a multiline terminal, press **Speaker**.  
 - OR -  
 At a single line telephone, lift the handset.
2. Dial the Call Forwarding Split Service Code (default not assigned).
3. Dial **3** (CTX/PBX).
4. Dial **1** (Set).
5. Dial number to Centrex Forward to.
6. Hang up.

### To cancel Call Forwarding – Centrex:

1. At a multiline terminal, press **Speaker**.  
 - OR -  
 At a single line telephone, lift the handset.
2. Dial the Call Forward Split Service Code (default not assigned).
3. Dial **0** (Cancel).
4. Dial 3 (CTX/PBX) or 0 (All).

## Call Forwarding, Off-Premise

### Description

Off-Premise Call Forwarding allows an extension user to forward their calls to an off-site location. By enabling Call Forward, Off-Premise, the user can stay in touch by having the system forward their calls while they are away from the office. The forwarding destination can be any telephone number the user enters, such as a mobile phone, home office, hotel or meeting room. Off-Premise Call Forwarding can route the off-site telephone number over a specific trunk or through a trunk group, Automatic Route Selection (ARS) or Trunk Group Routing.

Off-Premise Call Forwarding reroutes the following types of incoming calls:

- Ringing intercom calls from co-worker's extensions
- Calls routed from the VRS or Voice Mail <sup>1</sup>
- Direct Inward Lines <sup>1</sup>
- DISA, DID and Tie Line calls to the forwarded extension <sup>1</sup>
- Transferred calls <sup>1</sup>

Off-Premise Call Forwarding does not reroute Call Arrival (CAR) Keys, Call Arrival (CAR) Keys, or Ring Group calls (i.e., trunk ringing according to Ring Group assignments made in Program 22-04 and Program 22-05).

### Conditions

- If a call that forwards Off-Premise goes out on a trunk assigned as TIE or DID, and the called party does not answer before the time in Program 34-07-05, the call recalls to the station that performed the transfer.
- Call Forwarding Off-Premise requires either loop start trunks with disconnect supervision or ground start trunks.
- The trunk access code and the outside telephone number combined cannot exceed 24 digits.
- Call Forwarding an extension in a Department Group prevents that extension from receiving Department Pilot Calls.
- If a Programmable Function key is not defined for Call Forwarding (10~17), the DND key flashes to indicate that the extension is call forwarded.
- DID calls to an extension with Off-Premise Call Forwarding set do not recall if there is no answer.
- Door Boxes must be programmed for the calls to be transferred Off-Premise.

---

1. Off-Premise Call Forwarding can reroute an incoming trunk call only if the outgoing trunk selected has disconnect supervision enabled (refer to the Programming section).

- The outside number Call Forwarding dials can be only a number normally allowed by the forwarded extension Toll Restriction.
- If Fixed Messaging for VRS is enabled in Program 40-10-01, a caller to an extension forwarded Off-Premise will hear "Please hold on, your call is being rerouted."
- When a station is in DND and any Call Forwarding Off Premise is set, the call forwards immediately.
- Call Forwarding, Off-Premise is not supported when using Alternate Trunk Group Routing.

### Default Settings

Disabled

## System Availability

### Terminals

All Terminals

### Required Component(s)

None

## Related Features

- ➔ **Call Arrival (CAR) Keys**
- ➔ **Call Forwarding**
- ➔ **Code Restriction**
- ➔ **Direct Inward Dialing (DID)**
- ➔ **Door Box**
- ➔ **Do Not Disturb**
- ➔ **Video Conference with Web RTC**
- ➔ **Voice Response System (VRS)**

## Guide to Feature Programming

The **Level 1**, **Level 2** and **Level 3** columns indicate the programs that are assigned when programming this feature in the order they are most commonly used. These levels are used with PCPro and WebPro wizards for feature programming.

- Level 1 – these are the most commonly assigned programs for this feature.
- Level 2 – these are the next most commonly assigned programs for this feature.
- Level 3 – these programs are not often assigned and require an expert level working knowledge of the system to be properly assigned.

Program Number	Program Name/Description	Input Data	Default	Level		
				1	2	3
10-09-01	<b>DTMF and Dial Tone Circuit Setup</b> Allocate the circuits on the GCD-CP10 ETUs for either DTMF receiving or dial tone detection. Program 14-01-13 Basic Trunk Data Setup – Loop Supervision Enable (1) loop supervision for each trunk that should be able to use Call Forwarding Off-Premise.	0 = Common Use 1 = Extension Only 2 = Trunk Only	Circuit/Resource 01 ~ 08 = 1 (Extensions) Circuit/Resource 09 ~ 32 = 2 (Trunks) Circuit/Resource 33 ~ 144 = 0 (Common) When GPZ-BS10 is installed, 81 ~ 144 are available		✓	
11-07-01	<b>Department Group Pilot Numbers – Dial</b> Assign pilot numbers to each Department Group set up.	Dial (maximum of eight digits)	No Setting	✓		
11-11-01	<b>Service Code Setup (for Setup/Entry Operation) – Call Forward – All</b> Assign the Call Forward All Service Code.	MLT, SLT 0 ~ 9, *, # Maximum of eight digits	741		✓	
11-11-02	<b>Service Code Setup (for Setup/Entry Operation) – Call Forward – Busy</b> Assign the Call Forward Busy Service Code.	MLT, SLT 0 ~ 9, *, # Maximum of eight digits	742		✓	
11-11-03	<b>Service Code Setup (for Setup/Entry Operation) – Call Forward – No Answer</b> Assign the Call Forward No Answer Service Code.	MLT, SLT 0 ~ 9, *, # Maximum of eight digits	743		✓	
11-11-04	<b>Service Code Setup (for Setup/Entry Operation) – Call Forward – Busy/No Answer</b> Assign the Call Forward Busy No Answer Service Code.	MLT, SLT 0 ~ 9, *, # Maximum of eight digits	744		✓	
11-11-05	<b>Service Code Setup (for Setup/Entry Operation) – Call Forward – Both Ring</b> Assign the Call Forward Both Ring Service Code.	MLT, SLT 0 ~ 9, *, # Maximum of eight digits	745		✓	

Program Number	Program Name/Description	Input Data	Default	Level		
				1	2	3
11-11-45	<b>Service Code Setup (for Setup/Entry Operation) – Set/Cancel Call Forward All (Split)</b> Assign the Call Forward All Split Service Code.	MLT, SLT 0 ~ 9, *, # Maximum of eight digits	No Setting		✓	
11-11-46	<b>Service Code Setup (for Setup/Entry Operation) – Set/Cancel Call Forward Busy (Split)</b> Assign the Call Forward Busy Split Service Code.	MLT, SLT 0 ~ 9, *, # Maximum of eight digits	No Setting		✓	
11-11-47	<b>Service Code Setup (for Setup/Entry Operation) – Set/Cancel Call Forward No Answer (Split)</b> Assign the Call Forward No Answer Split Service Code.	MLT, SLT 0 ~ 9, *, # Maximum of eight digits	No Setting		✓	
11-11-48	<b>Service Code Setup (for Setup/Entry Operation) – Set/Cancel Call Forward Busy/ No Answer (Split)</b> Assign the Call Forward Busy No Answer Split Service Code.	MLT, SLT 0 ~ 9, *, # Maximum of eight digits	No Setting		✓	
11-11-49	<b>Service Code Setup (for Setup/Entry Operation) – Set/Cancel Call Forward Both Ring (Split)</b> Assign the Call Forward Both Ring Split Service Code.	MLT, SLT 0 ~ 9, *, # Maximum of eight digits	No Setting		✓	
11-11-52	<b>Service Code Setup (for Setup/Entry Operation) – Set/Cancel Call Forward All Destination (No Split)</b> Assign the Call Forward All for any Extension Service Code.	MLT, SLT 0 ~ 9, *, # Maximum of eight digits	790		✓	
11-11-53	<b>Service Code Setup (for Setup/Entry Operation) – Set/Cancel Call Forward Busy Destination (No Split)</b> Assign the Call Forward Busy for any Extension Service Code.	MLT, SLT 0 ~ 9, *, # Maximum of eight digits	791		✓	
11-11-54	<b>Service Code Setup (for Setup/Entry Operation) – Set/Cancel Call Forward No Answer Destination (No Split)</b> Assign the Call Forward No Answer for any Extension Service Code.	MLT, SLT 0 ~ 9, *, # Maximum of eight digits	792		✓	
11-11-55	<b>Service Code Setup (for Setup/Entry Operation) – Set/Cancel Call Forward Busy/ No Answer Destination (No Split)</b> Assign the Call Forward Busy No Answer for any Extension Service Code.	MLT, SLT 0 ~ 9, *, # Maximum of eight digits	793		✓	
14-01-13	<b>Basic Trunk Data Setup – Trunk-to-Trunk Transfer</b> Enable/Disable loop supervision for the trunk.	0 = Disable (No) 1 = Enable (Yes)	1		✓	

Program Number	Program Name/Description	Input Data	Default	Level		
				1	2	3
15-07-01	<b>Programmable Function Keys</b> Assign functions to multiline terminal line keys.	Line Key 1 ~ 48 0 ~ 99 (Normal Function Code 751 by default) *00 ~ *99 (Appearance Function Code) (Service Code 752 by default)	Refer to the Programming Manual for default values.	✓		
20-06-01	<b>Class of Service for Extensions</b> Assign a Class of Service (1 ~ 15) to extensions.	Day Night/Mode: 1 ~ 8 Class of Service of Extensions (1 ~ 15)	Extension port 101 = Class 15 All other extension port = Class 1	✓		
20-09-01	<b>Class of Service Options (Incoming Call Service) – Second Call for DID/DISA/DIL/ E&amp;M Override</b> Turn Off or On an extension ability to receive a second call from a DID, DISA, DIL, or tie line caller.  ➡ <i>With this option set to 1, the destination extension must be busy for a second DNIS caller to ring through. If the destination extension does not have a trunk or CAP key available for the second call and a previous call is ringing the extension but has not yet been answered, the second caller hears busy regardless of this program setting.</i>	0 = Off 1 = On	COS 1 ~ 15 = 1	✓		
20-09-07	<b>Class of Service Options (Incoming Call Service) – Call Queuing</b> Turn Off or On an extension user ability to have calls queued if a call rings the extension when it is busy.  ➡ <i>Program 20-13-06 must be set to 0 (Off) for this feature to work.</i>	0 = Off 1 = On	COS 1 ~ 15 = 1	✓		
20-11-12	<b>Class of Service Options (Hold/Transfer Service) – Call Forwarding Off-Premise (External Call Forwarding)</b> Turn Off or On setting up Call Forwarding Off-Premise at the extension.	0 = Off 1 = On	COS 1 ~ 15 = 0	✓		
20-13-05	<b>Class of Service Options (Supplementary Service) – Intercom Off-Hook Signaling</b> Turn Off or On an extension ability to send off-hook Signals.  ➡ <i>This setting functions with Programs 20-09-07 and 20-13-06 disabled.</i>	0 = Off 1 = On	COS 1 ~ 15 = 1	✓		
20-13-06	<b>Class of Service Options (Supplementary Service) – Automatic Off-Hook Signaling (Automatic Override)</b> Allow a busy extension user to Manually (0) or Automatically (1) receive off-hook signals.  ➡ <i>This setting is to receive incoming call signaling information during call queuing.</i>	0 = Off 1 = On	COS 1 ~ 15 = 1	✓		

Program Number	Program Name/Description	Input Data	Default	Level		
				1	2	3
21-03-01	<b>Trunk Group Routing for Trunks</b> Used to set the Trunk Route Table for Automatic External Call Forward.	Day Night/Mode: 1 ~ 8 0 ~ 100 (0 = No setting)	1		✓	
24-02-07	<b>System Options for Transfer – Trunk-to-Trunk Transfer Release Warning Tone</b> Timer starts when a trunk begins talking with another trunk (for example: Trunk-to-Trunk Transfer, outgoing from trunk, Tandem Trunking). When this time expires, a warning tone is heard.	0 ~ 64800 seconds	1800		✓	
24-09-01	<b>Call Forward Split Settings – Call Forwarding Type</b> Assign Call Forwarding Type and destination numbers for each extension/virtual extension.	0 = No Call Forwarding 1 = Call Forward Both 2 = Call Forward No Answer 3 = Call Forward All 4 = Call Forward Busy No Answer 5 = Call Forward Busy	0	✓		
24-09-02	<b>Call Forward Split Settings – CO Call Forwarding Destination for Both Ring, All Call, No Answer</b> Assign CO Call Forwarding destination numbers for both ring, all call and no answer.	Maximum of 24 digits (0 ~ 9, *, #, @, P, R) @ = Wait for Answer Supervision - ISDN trunks only P = Pause - Analog Trunk Only R = Hook flash - Analog Trunk Only	No Setting	✓		
24-09-03	<b>Call Forward Split Settings – Intercom Call Forwarding Destination for both ring, All Call, No Answer</b> Assign Intercom Call Forwarding destination numbers for both ring, all call and no answer.	Maximum of 24 digits (0 ~ 9, *, #, @, P, R) @ = Wait for Answer Supervision - ISDN trunks only P = Pause - Analog Trunk Only R = Hook flash - Analog Trunk Only	No Setting	✓		
24-09-04	<b>Call Forward Split Settings – CO Call Forwarding Busy Destination</b> Assign CO Call Forwarding busy destination numbers.	Maximum of 24 digits (0 ~ 9, *, #, @, P, R) @ = Wait for Answer Supervision - ISDN trunks only P = Pause - Analog Trunk Only R = Hook flash - Analog Trunk Only	No Setting	✓		
24-09-05	<b>Call Forward Split Settings – Intercom Call Forwarding Busy Destination</b> Assign Intercom Call Forwarding busy destination numbers.	Maximum of 24 digits (0 ~ 9, *, #, @, P, R) @ = Wait for Answer Supervision - ISDN trunks only P = Pause - Analog Trunk Only R = Hook flash - Analog Trunk Only	No Setting	✓		



Program Number	Program Name/Description	Input Data	Default	Level		
				1	2	3
24-09-06	<b>Call Forward Split Settings – Call Forwarding Destination for CTX/PBX for All Call, No Answer</b> Assign Call Forwarding destination numbers for CTX/PBX for all call and no answer.	Maximum of 24 digits (0 ~ 9, *, #, @, P, R) @ = Wait for Answer Supervision - ISDN trunks only P = Pause - Analog Trunk Only R = Hook flash - Analog Trunk Only	No Setting	✓		
24-09-07	<b>Call Forward Split Settings – Call Forwarding Destination for CTX/PBX for Busy</b> Assign Call Forwarding destination numbers for CTX/PBX for busy.	Maximum of 24 digits (0 ~ 9, *, #, @, P, R) @ = Wait for Answer Supervision - ISDN trunks only P = Pause - Analog Trunk Only R = Hook flash - Analog Trunk Only	No Setting	✓		
25-07-07	<b>System Timers for VRS/DISA – Long Conversation Warning Tone Time</b> Determine the time a DISA caller or any Trunk-to-Trunk (such as Tandem Trunking) conversation can talk before the Long Conversation tone is heard.	0 ~ 64800 seconds	3600		✓	
25-07-08	<b>System Timers for VRS/DISA – Long Conversation Disconnect Time</b> Determine how long the system waits before disconnecting a DISA or any trunk-to-trunk (such as Tandem Trunking) call after the Long Conversation tone is heard.	0 ~ 64800 seconds	10		✓	

**Trunk-to-Trunk Forwarding – Normal (0) Trunks:**

Program Number	Program Name/Description	Input Data	Default	Level		
				1	2	3
11-10-06	<b>Service Code Setup (for System Administrator) – Setting the Automatic Transfer for each Trunk Line</b> Customize the service code to be used to set the Automatic Trunk Forwarding feature.	MLT 0 ~ 9, *, # Maximum of eight digits	733		✓	
11-10-07	<b>Service Code Setup (for System Administrator) – Canceling the Automatic Transfer for each Trunk Line</b> Customize the service code to be used to cancel the Automatic Trunk Forwarding feature.	MLT 0 ~ 9, *, # Maximum of eight digits	734		✓	
11-10-08	<b>Service Code Setup (for System Administrator) – Setting the Destination for Automatic Trunk Transfer</b> Customize the service code to be used to set the destination for the Automatic Trunk Forwarding feature.	MLT 0 ~ 9, *, # Maximum of eight digits	735		✓	

Program Number	Program Name/Description	Input Data	Default	Level		
				1	2	3
13-01-01	<b>Speed Dialing Option Setup – Speed Dialing Auto Outgoing Call Mode</b> Determine if dialing an Speed Dialing number will dial an outside number (seizing a trunk as assigned in Program 13-05) or an Intercom number (0 = Trunk Dialing Mode, 1 = Extension Dialing Mode).	0 = Trunk Outgoing Mode 1 = Intercom Outgoing Mode	0	✓		
13-04-01	<b>Speed Dialing Number and Name – Speed Dialing Data</b> Enter the Common and Group Speed Dialing numbers and names which are to be used for Trunk-to-Trunk Forwarding.	Maximum of 24 digits (0 ~ 9, *, #, @, P, R) @ = Wait for Answer Supervision - ISDN trunks only P = Pause - Analog Trunk Only R = Hook flash - Analog Trunk Only	No Setting	✓		
14-01-26	<b>Basic Trunk Data Setup – Automatic Trunk-to-Trunk Transfer Mode</b> Enable (1)/Disable (0) each trunk ability to use Step Transfer.	0 = Normal Transfer (Normal) 1 = Step Transfer (Step)	0	✓		
20-06-01	<b>Class of Service for Extensions</b> Assign a Class of Service (1 ~ 15) to extensions.	Day Night/Mode: 1 ~ 8 Class of Service of Extensions (1 ~ 15)	Extension port 101 = Class 15 All other extension port = Class 1	✓		
20-07-05	<b>Class of Service Options (Administrator Level) – Set/Cancel Automatic Trunk-to-Trunk Transfer</b> Turn Off or On an extension user ability to use the Trunk-to-Trunk Forwarding service codes.	0 = Off 1 = On	COS 1 ~ 15 = 0	✓		
22-02-01	<b>Incoming Call Trunk Setup – Incoming Type</b> Assign the incoming trunk type for each trunk. There is one item for each Mode. When using Trunk-to-Trunk Forwarding the trunks must be set for Normal (0).	Incoming Type for Day/Night Mode (1 ~ 8): 0 = Normal 1 = VRS (second dial tone if no VRS installed) 2 = DISA 3 = DID 4 = DIL 5 = E&M Tie line 6 = Delayed VRS 7 = ANI/DNIS 8 = DID(DDI) Mode Switching	0	✓		
24-02-11	<b>System Options for Transfer – No Answer Step Transfer</b> Assign the amount of time each transfer destination rings before step transfer is performed.	0 ~ 64800 seconds	10	✓		

Program Number	Program Name/Description	Input Data	Default	Level		
				1	2	3
24-02-12	<b>System Options for Transfer – No Answer Trunk-to-Trunk Transfer</b> Define the time that elapses before the automatic Trunk-to-Trunk Transfer is performed.	0 ~ 64800 seconds	0	✓		
24-04-01	<b>Automatic Trunk-to-Trunk Transfer Target Setup</b> Assign the Speed Dialing number bin (0 ~ 9999) to a trunk and the mode which should be used as the destination of the Automatic Trunk-to-Trunk Forwarding.	0 ~ 9999	9999	✓		

**Trunk-to-Trunk Forwarding – DID (3) Trunk Forwarding by Department Groups:**

◇ Refer to *Department Calling on page 2-386* for additional Department Group programming.

Program Number	Program Name/Description	Input Data	Default	Level		
				1	2	3
11-07-01	<b>Department Group Pilot Numbers – Dial</b> Assign pilot numbers to the Extension (Department) Groups you set up in Program 16-02.	Dial (maximum of eight digits)	No Setting	✓		
11-11-25	<b>Service Code Setup (for Setup/Entry Operation) – Automatic Transfer Setup for Each Extension Group</b> Customize the service code to be used to set the Automatic Trunk Forwarding feature for a Department Group.	MLT, SLT 0 ~ 9, *, # Maximum of eight digits	602		✓	
11-11-26	<b>Service Code Setup (for Setup/Entry Operation) – Automatic Transfer Cancellation for Each Extension Group</b> Customize the service code to be used to cancel the Automatic Trunk Forwarding feature for a Department Group.	MLT, SLT 0 ~ 9, *, # Maximum of eight digits	603		✓	
11-11-27	<b>Service Code Setup (for Setup/Entry Operation) – Destination of Automatic Transfer Each Extension Group</b> Customize the service code to be used to set the destination for the Automatic Trunk Forwarding feature for a Department Group.	MLT 0 ~ 9, *, # Maximum of eight digits	604		✓	
13-01-01	<b>Speed Dialing Function Setup – Speed Dialing Auto Outgoing Call Mode</b> Determine if dialing an Speed Dialing number will dial an outside number (seizing a trunk as assigned in Program 13-05) or an Intercom number (0 = Trunk Dialing Mode, 1 = Extension Dialing Mode).	0 = Trunk Outgoing Mode 1 = Intercom Outgoing Mode	0	✓		

Program Number	Program Name/Description	Input Data	Default	Level		
				1	2	3
13-04-01	<b>Speed Dialing Number and Name – Speed Dialing Data</b> Enter the Common and Group Speed Dialing numbers and names which are to be used for Trunk-to-Trunk Forwarding.	Maximum of 24 digits (0 ~ 9, *, #, @, P, R) @ = Wait for Answer Supervision - ISDN trunks only P = Pause - Analog Trunk Only R = Hook flash - Analog Trunk Only	No Setting	✓		
14-01-04	<b>Basic Trunk Data Setup – Transmit Gain Level for Conference and Transfer Calls</b> CODEC gain set at 0 dB [Program 14-01-04 = 32 (CODEC Gain Type 2)] can be used to set the transmit CODEC gain type for multiline Conference or transferred calls.	1 ~ 57 (-15.5dB ~ +12.5dB in 0.5dB intervals)	32 (0 dB)		✓	
14-01-05	<b>Basic Trunk Data Setup – Receive Gain Level for Conference and Transfer Calls</b> CODEC gain set at 0 dB [Program 14-01-04 = 32 (CODEC Gain Type 2)] can be used to set the transmit CODEC gain type for multiline Conference or transferred calls.	1 ~ 57 (-15.5dB ~ +12.5dB in 0.5dB intervals)	16 (-8 dB)		✓	
14-06-01	<b>Trunk Group Routing – Priority Order Number</b> Set the priority order number 1 ~ 4.	0 = Not Set 1 ~ 100 = Trunk group No. 1001 ~ 1100 = 1000 + Route Table No.	Refer to the Programming Manual for default values.	✓		
15-07-01	<b>Programmable Function Keys</b> Assign an Automatic Forwarding at Department Group key (58) or a Delayed Forwarding at Department Group key (59) for an extension user.	Line Key 1 ~ 48 0 ~ 99 (Normal Function Code 751 by default) *00 ~ *99 (Appearance Function Code) (Service Code 752 by default)	Refer to the Programming Manual for default values.	✓		
16-02-01	<b>Department Group Assignment for Extensions</b> Set up the Department Group called by the pilot number and the extension priority when a group is called. Call Pickup Groups are set up in 23-02.	Department Groups 1 ~ 64 Priority 1 ~ 9999	Default = 1 extensions in Department Group 1 with priority in port order: Port 1 priority = 1 Port 256 priority = 256	✓		
20-06-01	<b>Class of Service for Extensions</b> Assign a Class of Service (1 ~ 15) to extensions.	Day Night/Mode: 1 ~ 8 Class of Service of Extensions (1 ~ 15)	Extension port 101 = Class 15 All other extension port = Class 1	✓		
20-11-17	<b>Class of Service Options (Hold/Transfer Service) – Department Group Trunk-to-Trunk Transfer (Each Telephone Group Transfer)</b> Turn On or Off an extension in a Department Group ability to use the Trunk-to-Trunk Forwarding service codes.	0 = Off 1 = On	COS 1 ~ 15 = 1		✓	

Program Number	Program Name/Description	Input Data	Default	Level		
				1	2	3
24-05-01	<b>Department Group Transfer Target Setup</b> Assign the Speed Dialing number bin to be used as the destination of the Department Group Trunk-to-Trunk Forwarding.	0 ~ 9999	9999	✓		

**Trunk-to-Trunk Forwarding – DID (3) Trunk Forwarding Using DID Translation Table:**

◇ Refer to *Direct Inward Dialing (DID)* on page 2-418 for additional DID programming.

Program Number	Program Name/Description	Input Data	Default	Level		
				1	2	3
22-11-05	<b>DID Translation Table Number Conversion – Transfer Destination Number 1</b> For each DID Translation Table entry (1 ~ 4000), specify the first and second Transfer Destinations if the callers receives a busy or no answer (action defined in Program 22-11-04). ➡ <i>If the Transfer Destinations are busy or receive no answer, those calls are transferred to the final transfer destination (Program 22-10).</i>	0 = No Setting 1 ~ 1 00 = Incoming Group 101 = (Not Used) 102 = In-Skin/External Voice Mail or InMail 201 ~ 264 = Extension Group 400 = Valid Extension Number 401 = DISA 501 ~ 599 = DISA/VRS Message 1000 ~ 1999 = Speed Dial Number (000 ~ 999)	0	✓		
22-11-06	<b>DID Translation Table Number Conversion – Transfer Destination Number 2</b> For each DID Translation Table entry (1 ~ 4000), specify the first and second Transfer Destinations if the callers receives a busy or no answer (action defined in Program 22-11-04). ➡ <i>If the Transfer Destinations are busy or receive no answer, those calls are transferred to the final transfer destination (Program 22-10).</i>	0 = No Setting 1 ~ 1 00 = Incoming Group 101 = (Not Used) 102 = In-Skin/External Voice Mail or InMail 201 ~ 264 = Extension Group 400 = Valid Extension Number 401 = DISA 501 ~ 599 = DISA/VRS Message 1000 ~ 1999 = Speed Dial Number (000 ~ 999)	0	✓		

**Operation**

**To activate Call Forwarding Off-Premise non-split:**

- At a multiline terminal, press **Speaker**.  
- OR -  
At a single line telephone, lift the handset.

2. Dial the Call Forwarding Service Code.

- OR -

At a multiline terminal only, press the Call Forwarding Programmable Function keys (Program 15-07-01, Program 15-07-10~Program 15-07-15 or SC 751 Key Code 10~15).

3. Dial **1** (Set).
4. Dial the Trunk Access Code (default: 9) + Number (9+2142622000).
  - ◇ *Trunk access codes are 9 (ARS/Trunk Group Routing), 704 + Line Group (1~9, 01~99 or 001~100) or #9 + Line number (e.g., 05 or 005 for line 5).*
  - ◇ *Your DND or Call Forwarding (Device) Programmable Function key flashes.*

#### To cancel Call Forwarding Off-Premise non-split:

1. At a multiline terminal, press **Speaker**.

- OR -

At a single line telephone, lift the handset.

2. Dial the Call Forward Access Code (default not assigned).
3. Dial **0** (Cancel).

#### To activate Call Forwarding Off-Premise Split:

1. At a multiline terminal, press **Speaker**.

- OR -

At a single line telephone, lift the handset.

2. Dial the Call Forwarding Service Code.
3. Dial **1** (Set).
4. Dial **1** (Internal) or **0** (External).
5. Dial Trunk Access Code (default: 9) + number (9 + 2142622000).
  - ◇ *Trunk access codes are 9 (ARS/Trunk Group Routing), 704 + Line Group (1~9, 01~99 or 001~100) or #9 + Line number (e.g., 05 or 005 for line 5).*
  - ◇ *Your DND or Call Forwarding (Device) Programmable Function key flashes.*

#### To cancel Call Forwarding Off-Premise Split:

1. At the multiline terminal, press **Speaker**.

- OR -

2. At a single line telephone, lift the handset.
3. Dial the Call Forward Access Code (default not assigned).

4. Dial **0** (Cancel).
  - ◇ *If Internal and External are set both are canceled.*
  - ◇ *Your DND or Call Forwarding (Device) Programmable Function key flashes.*

### Off-Premise Call Forwarding for Door Boxes



*These operations are performed at the Door Box Ringing Extension only.*

NOTE

### To activate Call Forwarding Off-Premise for a Door Box:



*This option only works for ISDN PRI or BRI Trunks.*

NOTE

1. At the multiline terminal, press **Speaker** + dial SC **722**.
  - OR -
  - At the multiline terminal only, press Call Forward (Device) key (Program 15-07-01 or SC 751, code 54).
  - OR -
  - At the single line telephone, lift the handset + dial **722**.
2. Dial the Door Box number (**1~4**).
3. Dial the Speed Dialing number where the calls should be forwarded.
4. Press **Speaker** (or hang up at the single line telephone) to hang up.

### To cancel Call Forwarding Off-Premise for a Door Box:

1. At the multiline terminal, press **Speaker** + dial SC **722**.
  - OR -
  - At the multiline terminal only, press Call Forward (Device) key (Program 15-07-01 or SC 751, code 54).
  - OR -
  - At the single line telephone, lift the handset + dial **722**.
2. Dial **0** (Cancel).

### Trunk-to-Trunk Forwarding

#### Set the Destination and Forward the Line:

1. Lift the handset.
2. Dial **735**.

3. Dial trunk port number (**001~400**) to be defined.
4. Select the mode (**1~8**) to be defined.
5. Enter the telephone number, which is the destination of the forwarded trunk.
  - ◇ *The number is stored in the Speed Dial bin number assigned in Program 24-04-01. This entry overwrites any existing number defined in the bin.*
6. Press **Hold** to accept the entry.
7. Repeat from Step 3 to define another mode entry or press **Speaker** to hang up.

#### Cancel the Line Forwarding:

1. Lift the handset.
2. Dial **735**.
3. Dial trunk port number (**001~400**) to be defined.
4. Select the mode (**1~8**) to be defined.
5. Press the **Exit** key.
6. Press **Speaker** to hang up.

#### Automatic Trunk-to-Trunk Transfer (Step Transfer) (follows the predefined destination in Program 24-04-01) Set Automatic Trunk Forwarding:



*The Speed Dial bin must be defined in Program 13-04-01 for the line to forward.*

NOTE

1. Lift the handset.
2. Dial **733**.
3. Dial trunk port number to be used (**001~400**).
4. Press **Speaker** to hang up.

#### Cancel Automatic Trunk Forwarding:

1. Lift the handset.
2. Dial **734**.
3. Dial trunk port number to be used (**001~400**).
4. Press **Speaker** to hang up.

### Department Group Line Forwarding

#### Method 1:

##### Set the Destination and Forward the Line:

1. Lift the handset.



2. Dial **604**.
3. Dial the Department Group number (**01~64**) to be defined.
4. Select the time mode (**1~8**) to be defined.
5. Enter the telephone number, which is the destination of the forwarded trunk.
  - ◇ *The number is stored in the Speed Dial bin number assigned in Program 24-04-01. This entry overwrites any existing number defined in the bin.*
6. Press **Hold** to accept the entry.
7. Repeat from Step 3 to define another time mode entry or press **Speaker** to hang up.

**Cancel the Line Forwarding:**

1. Lift the handset.
2. Dial **604**.
3. Dial the Department Group number (**01~64**) to be defined.
4. Select the time mode (**1~8**) to be defined.
5. Press the **Exit** key.
6. Press **Speaker** to hang up.

**Method 2 (follows the pre-defined destination in Program 24-05-01)  
Set Automatic Trunk Forwarding:**



*The Speed Dial bin must be defined in Program 13-04-01 for the line to forward.*

NOTE

1. Lift the handset.
2. Dial **602**.
3. Dial the Department Group number (**01~64**) to be defined.
4. Press **Speaker** to hang up.

**Cancel Automatic Trunk Forwarding:**

1. Lift the handset.
2. Dial **603**.
3. Dial the Department Group number (**01~64**) to be defined.
4. Press **Speaker** to hang up.

## Call Forwarding/Do Not Disturb Override

### Description

An extension user can override Call Forwarding or Do Not Disturb at another extension. This is helpful, for example, to dispatchers and office managers that always need to get through.

#### Conditions

- When DND and any Call Forwarding is set, the call forwards immediately.

#### Default Settings

Disabled

### System Availability

#### Terminals

All Terminals

#### Required Component(s)

None

### Related Features

↳ **Programmable Function Keys**

### Guide to Feature Programming

The **Level 1**, **Level 2** and **Level 3** columns indicate the programs that are assigned when programming this feature in the order they are most commonly used. These levels are used with PCPro and WebPro wizards for feature programming.

- ❑ Level 1 – these are the most commonly assigned programs for this feature.
- ❑ Level 2 – these are the next most commonly assigned programs for this feature.
- ❑ Level 3 – these programs are not often assigned and require an expert level working knowledge of the system to be properly assigned.

Program Number	Program Name/Description	Input Data	Default	Level		
				1	2	3
11-12-01	<b>Service Code Setup (for Service Access) – Bypass Call</b> Customize the Service Code which is to be used for Call Forwarding/DND Override.	MLT, SLT 0 ~ 9, *, # Maximum of eight digits	707		✓	
11-16-06	<b>Single Digit Service Code Setup – DND/Call Forward Override Bypass</b> Customize the 1-digit Service Code used for DND/Call Forward Override.	0 ~ 9, *, # Maximum of one digit	No Setting	✓		
15-07-01	<b>Programmable Function Keys</b> Assign functions to multiline terminal line keys.	Line Key 1 ~ 48 0 ~ 99 (Normal Function Code 751 by default) *00 ~ *99 (Appearance Function Code) (Service Code 752 by default)	Refer to the Programming Manual for default values.	✓		
20-06-01	<b>Class of Service for Extensions</b> Assign a Class of Service (1 ~ 15) to extensions.	Day Night/Mode: 1 ~ 8 Class of Service of Extensions (1 ~ 15)	Extension port 101 = Class 15 All other extension port = Class 1	✓		
20-13-04	<b>Class of Service Options (Supplementary Service) – Call Forward/DND Override (Bypass Call)</b> Turn On or Off the ability to use Call Forwarding/DND Override.	0 = Off 1 = On	COS 1 ~ 15 = 1		✓	

## Operation

### To override an extension Call Forwarding or Do Not Disturb:

1. Call the forwarded or DND extension.
2. Press the Override key (Program 15-07 or SC 751: 37).

## Call Monitoring

### Description

Call Monitoring allows selected multiline terminal users to monitor another user's conversation without participating. A programmable audible alert tone can be sent to that station user. Without the audible alert (silent monitor), no indication is provided to either the monitored station or the outside party.



CAUTION

*The use of monitoring, recording, or listening devices to eavesdrop, monitor, retrieve, or record telephone conversation or other sound activities, whether or not contemporaneous with transmission, may be illegal in certain circumstances under federal or state laws. Legal advice should be sought prior to implementing any practice that monitors or records any telephone conversation. Some federal and state laws require some form of notification to all parties to a telephone conversation, such as using a beep tone or other notification methods or requiring the consent of all parties to the telephone conversation, prior to monitoring or recording the telephone conversation. Some of these laws incorporate strict penalties.*

### Call Monitoring with Coaching Ability

Call Monitoring with Coaching Ability allows the transmit path to be opened only to the monitored station, to provide the Coaching ability for the person that is performing the Call Monitoring. Press the MIC key, or dial Feature + 1 to toggle the Coaching ability on and off.

### Conditions

- An extension set as an operator in Program 20-17-01 cannot be monitored using the Contact Center Call Monitor (\*15 Feature key) Enhancement.
- While using the Contact Center Call Monitor (\*15 Feature key) Enhancement, if the monitored extension places the call on hold or transfers the call monitoring is stopped.
- The Contact Center Call Monitoring (\*15 Feature key) Enhancement is supported on trunk calls and is not supported on internal calls.
- If an extensions class of service has Program 20-13-06 or Program 20-09-07 enabled, the Contact Center Call Monitoring (\*15 Feature key) Enhancement does not work.
- No alert tone is provided to callers when using the Contact Center Call Monitor (\*15 Feature key) Enhancement feature.
- Speech path is not supported for the Contact Center Call Monitor (\*15 Feature key) Enhancement feature even when Program 20-13-10 is enabled.
- A maximum of 32 extensions can be monitored using the Contact Center Call Monitor (\*15 Feature key) Enhancement feature.
- Call Monitoring is allowed for internal calls.
- An extension user cannot Monitor an Intercom call if one of the Intercom callers is using Hands-free Answerback. Both Intercom parties must lift the handset or press **Speaker**.

- An extension user can monitor a conference call.
- With Program 20-13-10 set to 0, a call, which has been barged into, can be placed on hold by the originator of the outside call. Both the outside caller and the extension, which is monitoring the call, are placed on hold.
- The handset and microphone are muted during Call Monitoring.
- Live Record does not work for Call Monitor calls.
- While being monitored, an extension cannot receive Voice Over.
- When a monitored extension places a call on hold, Call Monitor is automatically finished.
- With Program 20-13-10 set to 1, a call which is being Monitored can be placed on park by the originator of the outside call, but only the outside caller is placed in park. The extension which is monitoring the call is dropped.
- When Program 20-13-10 is set to 0 (OFF), coaching is not permitted. When Program 20-13-10 is set to 1 (On), Program 20-13-45 takes effect.
- When Silent Monitor Mode is used, MIC or Feature + 1 can be used to activate speech path to the internal and external parties.
- Handset Mute cannot be enabled on a handset if the extension is being silent monitored.
- If Handset Mute is enabled on the handset and the extension is set to silent monitor, the handset is immediately un-muted.

## Default Settings

Disabled

## System Availability

### Terminals

All Terminals

### Required Component(s)

None

## Related Features

- ↳ **Barge-In**
- ↳ **Conference**
- ↳ **Hold**

- ➔ **Intercom**
- ➔ **Park**
- ➔ **Programmable Function Keys**
- ➔ **InMail**

## Guide to Feature Programming

The **Level 1**, **Level 2** and **Level 3** columns indicate the programs that are assigned when programming this feature in the order they are most commonly used. These levels are used with PCPro and WebPro wizards for feature programming.

- Level 1 – these are the most commonly assigned programs for this feature.
- Level 2 – these are the next most commonly assigned programs for this feature.
- Level 3 – these programs are not often assigned and require an expert level working knowledge of the system to be properly assigned.

Program Number	Program Name/Description	Input Data	Default	Level		
				1	2	3
11-12-08	<b>Service Code Setup (for Service Access) – Barge-In</b> Determine what the service code should be for an internal party to use the Barge-In feature.	MLT, SLT 0 ~ 9, *, # Maximum of eight digits	710		✓	
11-16-02	<b>Single Digit Service Code Setup – Barge-In</b> Customize the one-digit Service Codes used for Barge-In.	0 ~ 9, *, # Maximum of one digit	No Setting	✓		
15-07-01	<b>Programmable Function Keys</b> Assign functions to multiline terminal line keys.	Line Key 1 ~ 48 0 ~ 99 (Normal Function Code 751 by default) *00 ~ *99 (Appearance Function Code) (Service Code 752 by default)	Refer to the Programming Manual for default values.	✓		
20-02-27	<b>System Options for Multiline Telephones – Contact Center Monitor for Business Mode</b> Select whether or not Contact Center Call Monitor provided in the Contact Center Mode works in normal business mode.	0 = Off (Contact Center Mode) 1 = On (Business Mode)	0		✓	
20-06-01	<b>Class of Service for Extensions</b> Assign a Class of Service (1 ~ 15) to extensions.	Day Night/Mode: 1 ~ 8 Class of Service of Extensions (1 ~ 15)	Extension port 101 = Class 15 All other extension port = Class 1	✓		

Program Number	Program Name/Description	Input Data	Default	Level		
				1	2	3
20-09-07	<p><b>Class of Service Options (Incoming Call Service) – Call Queuing</b></p> <p>Turn Off or On an extension ability to have calls queued if a call rings the extension when it is busy.</p> <p>This setting must be Disabled (0) for the Call Monitoring Enhancement to function.</p> <p>➡ Program 20-13-06 must be set to 0 (Off) for this feature to work.</p>	<p>0 = Off</p> <p>1 = On</p>	COS 1 ~ 15 = 1		✓	
20-13-10	<p><b>Class of Service Options (Supplementary Service) – Barge-In Monitor</b></p> <p>Enable the extension Barge-In for Speech mode or Monitor mode (i.e., Barge-In initiator).</p>	<p>0 = Speech</p> <p>1 = Monitor</p>	COS 1 ~ 15 = 0	✓		
20-13-15	<p><b>Class of Service Options (Supplementary Service) – Barge-In, Initiate</b></p> <p>Turn Off or On an extension user ability to barge-in on other's calls.</p>	<p>0 = Off</p> <p>1 = On</p>	COS 1 ~ 15 = 0	✓		
20-13-16	<p><b>Class of Service Options (Supplementary Service) – Barge-In, Receive</b></p> <p>Turn Off or On an extension user ability to Barge-In at the receiving extension (i.e., Barge-In receive).</p> <p>This setting must be Enabled (1) for the Contact Center Call Monitoring Enhancement to function.</p>	<p>0 = Off</p> <p>1 = On</p>	COS 1 ~ 15 = 0	✓		
20-13-17	<p><b>Class of Service Options (Supplementary Service) – Barge-In Tone/Display (Intrusion Tone)</b></p> <p>Turn Off or On the Barge-In (Intrusion) Tone. If disabled, this also turns off the Barge-In display at the called extension.</p>	<p>0 = Off</p> <p>1 = On</p>	COS 1 ~ 15 = 1	✓		
20-13-32	<p><b>Class of Service Options (Supplementary Service) – Deny Multiple Barge-Ins</b></p> <p>Allow (1)/Deny (0) the extension user ability to have multiple users Barge-In to their conversation.</p>	<p>0 = Off</p> <p>1 = On</p>	COS 1 ~ 15 = 0		✓	
20-13-45	<p><b>Class of Service Options (Supplementary Service) – MIC Key Mode While Call Monitoring</b></p> <p>Set per class of service, when in Call Monitoring Mode determines if the monitored parties receives the barge in alert tone when Coaching Mode is enabled.</p>	<p>0 = Enable</p> <p>1 = Disable</p>	COS 1 ~ 15 = 1		✓	
20-14-11	<p><b>Class of Service Options for DISA/E&amp;M – DISA/Tie Trunk Barge-In</b></p> <p>Enable (1)/Disable (0) a DISA or tie trunk user from using the Barge-In feature.</p>	<p>0 = Off</p> <p>1 = On</p>	COS 1 ~ 15 = 0	✓		

Program Number	Program Name/Description	Input Data	Default	Level		
				1	2	3
20-17-01	<b>Operator Extension – Operator’s Extension Number</b> Define the extension numbers which are to be used by operators. Extensions defined in this program cannot be monitored using the Call Enhancement feature.	Maximum of eight digits	101		✓	
20-18-07	<b>Service Tone Timers – Intrusion Tone Repeat Time</b> After a user Barges In, the system repeats the Barge-In tone after this time. Normally, you should disable this time by entering 0. (This time also affects any other type of call interruption features, such as Voice Mail Conversation Recording, Voice Over, etc.)	0 ~ 64800 seconds	0		✓	
21-01-03	<b>System Options for Outgoing Calls – Trunk Interdigit Time (External)</b> Program the time an extension must wait before using the Barge-In feature can be used on a call (this time expires before a call is put in a talk state). This time also affects Voice Over.	0 ~ 64800 seconds	5		✓	

## Operation

The call must be set up for about 10 seconds before it can be Monitored. Listen for busy/ring or busy tone.

### To Call Monitor after calling a busy extension:

1. Call a busy extension.
2. Press the Barge-In key (Program 15-07 or SC 751: 34).

- OR -

The following steps are not available for DISA or Tie Line trunks.

1. Dial the extension number of the busy internal party.
2. Dial the single digit service code or the service code **710**.

### To Call Monitor without first calling the busy extension:

1. Press **Speaker** or lift handset.
2. Dial **710** or press the Barge-In key (Program 15-07 or SC 751: 34).



3. Dial a busy extension.
  - ◇ *If Monitoring is not possible:*
    - the extension user hears a warning tone.*
    - the DISA user is rerouted to the defined ring group.*
    - the Tie Line user hears a busy tone.*

**To Call Monitor using Coaching Ability:**

1. Call a busy extension.
  2. Press the **Barge-In** key (Program 15-07 or SC 751:34).
  3. Press **MIC** or **Feature + 1** to toggle Coaching Ability on and off to the monitored station.
- OR -
1. Dial the extension number of the busy party.
  2. Dial the single digit service code or the service code **710**.
  3. Press **MIC** or **Feature + 1** to toggle Coaching Ability on and off.

**To Call Monitor using Coaching Ability without first calling the busy extension:**

1. Press **Speaker** or lift the handset.
2. Dial **710** or press the **Barge-In** key (Program 15-07 or SC 751:34).
3. Dial a busy extension.
4. Press **MIC** or **Feature + 1** to toggle Coaching Ability on and off to the monitored station.

**To Call Monitor after calling a busy extension using Contact Center Call Monitor:**

1. Call a busy extension.
2. Press the Contact Center Terminal Speech Monitor key (Program 15-07 or SC 752:\*15).

## Call Redirect

### Description

Call Redirect allows a multiline terminal user to transfer a call to a predefined destination (such as an operator, voice mail, or another extension) without answering the call. This can be useful if you are on a call and another rings in to your extension. Press the Call Redirect key to transfer the call, allowing you to continue with your current call.

This feature works with the following calls: Normal trunk call

- DID
- DISA
- DIL
- E&M
- ICM

The following calls *cannot* be redirected with the feature:

- Contact Center
- Transferred
- Department Group (all ring mode)
- Door Box
- Virtual Extension

### Conditions

- After pressing the Call Redirect key, the call does not recall to the extension.
- The predefined destination must be an extension number or voice mail pilot number.
- When a call is Redirected to another phone it does not follow the forwarding on that phone.
- A call cannot be redirected across a CCIS Network.

### Default Settings

Enabled

## System Availability

### Terminals

All Multiline Terminals

### Required Component(s)

None

## Related Features

None

## Guide to Feature Programming

The **Level 1**, **Level 2** and **Level 3** columns indicate the programs that are assigned when programming this feature in the order they are most commonly used. These levels are used with PCPro and WebPro wizards for feature programming.

- Level 1 – these are the most commonly assigned programs for this feature.
- Level 2 – these are the next most commonly assigned programs for this feature.
- Level 3 – these programs are not often assigned and require an expert level working knowledge of the system to be properly assigned.

Program Number	Program Name/Description	Input Data	Default	Level		
				1	2	3
15-07-01	<b>Programmable Function Keys</b> Assign functions to multiline terminal line keys.	Line Key 1 ~ 48 0 ~ 99 (Normal Function Code 751 by default) *00 ~ *99 (Appearance Function Code) (Service Code 752 by default)	Refer to the Programming Manual for default values.	✓		
20-06-01	<b>Class of Service for Extensions</b> Assign a Class of Service (1 ~ 15) to extensions.	Day Night/Mode: 1 ~ 8 Class of Service of Extensions (1 ~ 15)	Extension port 101 = Class 15 All other extension port = Class 1	✓		
20-11-16	<b>Class of Service Options (Hold/Transfer Service) – Call Redirect</b> Turn Off or On an extension user ability to transfer a call to a predefined destination (such as an operator, voice mail, or another extension) without answering the call.	0 = Off 1 = On	COS 1 ~ 15 = 1	✓		

## Operation

### To redirect a ringing call:

With an incoming call ringing your extension, press the Call Redirect key (Program 15-07 or SC 751: 49 + Destination Extension Number) without lifting the handset.

## Call Waiting/Camp-On

### Description

With Call Waiting, an extension user may call a busy extension and wait in line (Camp-On) without hanging up. When the user Camps-On, the system signals the busy extension with two beeps indicating the waiting call. The call goes through when the busy extension becomes free. Call Waiting helps busy extension users know when they have additional waiting calls. It also lets callers wait in queue for a busy extension without being forgotten.

### Conditions

- Call Arrival (CAR) Key (virtual extension) keys do not support Call Waiting/Camp-On Programmable Function keys (code 35).
- If an extension user Camps-On and then hangs up, the system converts the Camp-On to a callback.
- Off-Hook Signaling gives an extension the ability to block a caller from dialing 750 to Camp-On and/or DID callers from automatically camping on.
- Function keys simplify Call Waiting/Camp-On operation.
- An extension user may Transfer a call to a busy extension.
- Trunk Queuing lets an extension user camp-on to a trunk.
- Call Queuing must be disabled also to disable Call Waiting.

### Default Settings

Enabled

### System Availability

#### Terminals

All Terminals

#### Required Component(s)

None

## Related Features

- [Callback](#)
- [Off-Hook Signaling](#)
- [Programmable Function Keys](#)
- [Transfer](#)
- [Trunk Queuing/Camp-On](#)

## Guide to Feature Programming

The **Level 1**, **Level 2** and **Level 3** columns indicate the programs that are assigned when programming this feature in the order they are most commonly used. These levels are used with PCPro and WebPro wizards for feature programming.

- Level 1 – these are the most commonly assigned programs for this feature.
- Level 2 – these are the next most commonly assigned programs for this feature.
- Level 3 – these programs are not often assigned and require an expert level working knowledge of the system to be properly assigned.

Program Number	Program Name/Description	Input Data	Default	Level		
				1	2	3
11-11-23	<b>Service Code Setup (for Setup/Entry Operation) – Second Call for DID/DISA/DIL</b> This service code enables Second Call to each extension when Program 20-09-01 (Second Call) is set to 0 (disable).	MLT 0 ~ 9, *, # Maximum of eight digits	679		✓	
11-12-04	<b>Service Code Setup (for Service Access) – Set Camp-On</b> Customize the Service Code, which is to be used for setting Camp-On.	MLT, SLT 0 ~ 9, *, # Maximum of eight digits	750		✓	
11-12-05	<b>Service Code Setup (for Service Access) – Cancel Camp-On</b> Customize the Service Code, which is to be used for cancelling Camp-On.	MLT, SLT 0 ~ 9, *, # Maximum of eight digits	770		✓	
11-12-47	<b>Service Code Setup (for Service Access) – Call Waiting Answer/Split Answer</b> If required, use this program to change the code users dial to Split while on a call.	SLT 0 ~ 9, *, # Maximum of eight digits	794		✓	
11-16-05	<b>Single Digit Service Code Setup – Camp-On</b> Customize the 1-digit Service Code used for setting Camp-On.	0 ~ 9, *, # Maximum of one digit	#		✓	

Program Number	Program Name/Description	Input Data	Default	Level		
				1	2	3
15-02-06	<b>Multiline Telephone Basic Data Setup – Hold Key Operating Mode</b> Set the function of the Multiline Hold key. Hold can activate normal Hold or Exclusive Hold.	0 = Normal (Common) 1 = Exclusive Hold	0		✓	
15-02-12	<b>Multiline Telephone Basic Data Setup – Off-Hook Ringing</b> Set the telephone off-hook signaling.	0 = Muted Off-Hook Ringing 1 = No Off-Hook Ringing 2 = Not Used 3 = Beep in Speaker (SP) 4 = Beep in Handset (HS) 5 = Speaker & Handset Beep	5	✓		
15-07-01	<b>Programmable Function Keys</b> Assign a function for Camp-On (code 35). This key is also the Callback key.	Line Key 1 ~ 48 0 ~ 99 (Normal Function Code 751 by default) *00 ~ *99 (Appearance Function Code) (Service Code 752 by default)	Refer to the Programming Manual for default values.	✓		
20-01-08	<b>System Options – Trunk Queuing Callback Time</b> Set the Trunk Queuing callback time. A Trunk Queuing Callback rings an extension for this time.	0 ~ 64800 seconds	15		✓	
20-01-09	<b>System Options – Callback/Trunk Queuing Cancel Time</b> The system cancels an extension Callback or Trunk Queuing request after this time.	0 ~ 64800 seconds	64800		✓	
20-03-01	<b>System Options for Single Line Telephones – SLT Call Waiting for Answer Mode</b> For a busy single line (500/2500 type) telephone, set the mode used to answer a camped-on trunk call. For ESL sets, enabling this option (1) allows the user to dial Service Code for Voice Mail Conversation Record.	0 = Hookflash (Hooking) 1 = Hookflash + Service Code 794 ➡ <i>Service Code 654 is for Live Recording at SLT (Program 11-12-53).</i>	0		✓	
20-06-01	<b>Class of Service for Extensions</b> Assign a Class of Service (1 ~ 15) to extensions.	Day Night/Mode: 1 ~ 8 Class of Service of Extensions (1 ~ 15)	Extension port 101 = Class 15 All other extension port = Class 1	✓		

Program Number	Program Name/Description	Input Data	Default	Level		
				1	2	3
20-09-01	<p><b>Class of Service Options (Incoming Call Service) – Second Call for DID/DISA/DDI/DIL/ E&amp;M Override</b></p> <p>Turn Off or On an extension ability to receive a second call from a DID, DISA, DIL, or tie line caller.</p> <p>➤ <i>With this option set to 1, the destination extension must be busy for a second DNIS caller to ring through. If the destination extension does not have a trunk or CAP key available for the second call and a previous call is ringing the extension but has not yet been answered, the second caller hears busy regardless of this program setting.</i></p>	<p>0 = Off 1 = On</p>	COS 1 ~ 15 = 1		✓	
20-09-07	<p><b>Class of Service Options (Incoming Call Service) – Call Queuing</b></p> <p>Turn Off or On an extension ability to have calls queued if a call rings the extension when it is busy.</p> <p>➤ <i>Program 20-13-06 must be set to 0 (Off) for this feature to work.</i></p>	<p>0 = Off 1 = On</p>	COS 1 ~ 15 = 1		✓	
20-13-05	<p><b>Class of Service Options (Supplementary Service) – Intercom Off-Hook signaling</b></p> <p>Turn Off or On an extension ability to send off-hook signals.</p> <p>➤ <i>This setting functions with Programs 20-09-07 and 20-13-06 disabled.</i></p>	<p>0 = Off 1 = On</p>	COS 1 ~ 15 = 1		✓	
20-13-06	<p><b>Class of Service Options (Supplementary Service) – Automatic Off-Hook Signaling (Automatic Override)</b></p> <p>Allow a busy extension user to Manually (0) or Automatically (1) receive off-hook signals.</p> <p>➤ <i>This setting is to receive incoming call signaling information during call queuing.</i></p>	<p>0 = Off 1 = On</p>	COS 1 ~ 15 = 1		✓	
20-13-35	<p><b>Class of Service Options (Supplementary Service) – Block Camp-On</b></p> <p>Turn Off or On an extension user ability to block callers from dialing to camp-on.</p>	<p>0 = Off 1 = On</p>	COS 1 ~ 15 = 0	✓		
20-18-06	<p><b>Service Tone Timers – Interval of Call Waiting Tone</b></p> <p>Set the time between call waiting tones. This timer also sets the interval between off-hook signaling alerts.</p>	0 ~ 64800 seconds	10		✓	
21-01-18	<p><b>System Options for Outgoing Calls – Reset Dial After Failure of Trunk Access</b></p> <p>Enable/Disable an extension user ability to continue to dial codes or extensions after receiving Trunk Busy. This must be Enabled for this feature to work.</p>	<p>0 = Enable (On) 1 = Disable (Off)</p>	1	✓		



## Operation

### To Camp-On a busy extension:

1. Call the busy extension.
2. Dial # or press the Camp-On key (Program 15-07 or SC 751: 35).
3. Do not hang up.
  - ◇ *To camp-on to a trunk, refer to [Trunk Queuing/Camp-On on page 2-1665](#).*

### To cancel a Camp-On request:

1. Hang up.
2. At a multiline terminal, press **Speaker** and dial **770**.
  - OR -
  - At a multiline terminal, press the Camp-On key (Program 15-07 or SC 751: 35).
  - OR -
  - At the single line telephone, lift the handset and dial **770**.

### To Split (answer a waiting call) at a single line telephone:

Listen for Call Waiting Tones.

1. Hookflash and dial **794** to repeatedly split between the two calls.
  - ◇ *The operation depends on the setting in Program 20-03-01.*
  - ◇ *This operation is valid only before the caller performs the camp-on operation (refer To Camp-On a busy extension – step 2).*

## Central Office Calls, Answering

### Description

The system provides flexible routing of incoming CO (trunks) calls to meet the exact site requirements. This lets trunk calls ring and be answered at any combination of system extensions. A maximum of 400 trunks are available. For additional information on making trunks ring, refer to [Ring Groups on page 2-1371](#).

### Delayed Ringing

Extensions in a Ring Group can have delayed ringing for trunks. If the trunk is not answered at its original destination, it rings the DIL No Answer Ring Group (this ring group applies to DIL or non-DIL trunks). This could help a secretary that covers calls for their boss. If the boss does not answer the call, it rings the secretary's telephone after a programmable interval.

### Universal Answer

Universal Answer allows an employee to answer a call by going to any multiline terminal and dialing a unique Universal Answer code. The employee does not have to know the trunk number or dial any other codes to pick up the ringing trunk. You normally set up Universal Answer along with Universal Night Answer (refer to [Night Service on page 2-1226](#)). When a Universal Night Answer call rings the External Paging, an employee can answer the call from the first available telephone. You might also want to use Universal Answer in a noisy warehouse or machine shop where the volume of normal telephone ringing is not adequate. After hearing the ringing over the Paging, an employee can then easily pick up the call from a shop telephone.

The Automatic Off-Hook Answer of Universal Answer Call options (Program 20-10-07) determines whether or not the extension has the Auto Answer feature for ringing calls. This option allows a user to lift the handset to answer a ringing call; dialing the service code is unnecessary.

### Additional Trunk Ring Tones

Various ring tone patterns and melodies for incoming calls are available (Program 22-03-11); Ring Tone Patterns 1~4 and Melodies 1~5.

### Sidetone Volume Setup

This option allows system programming for the multiline terminal side tone volume. There are two levels, based on whether the connected trunk is a digital trunk or analog trunk.

### Side Tone Auto Setup

Per each analog trunk (or all analog trunks) the most suitable Codec Filter setting for Program 81-07 and Program 81-17 can be automatically adjusted using Programs 90-68-01 and 90-68-02.

During the trunk measurement process, the following LCD indications are provided:

- During measurement: Measurement (x/4)  
x = number of measurements
- Measure complete: Complete  
Error condition: Error  
Trunk busy: Busy

After successful measurement, the option to copy the same settings to all analog trunks is shown.



NOTE

*Side Tone Auto Setup available when the system is in an idle condition.*

## Conditions

- The incoming ring group assignment programmed in Program 41-03-01 overrides the setting in Program 22-05-01.
- Ringing calls can be picked up regardless of access map programming.
- An extension user can answer an outside call just by lifting the handset.
- Long Conversation Cutoff can disconnect incoming and outgoing CO calls after a set time period. Using the Warning Tone for Long Conversation feature allows users on outgoing calls to hear a warning tone prior to the call disconnecting.
- Line keys and Call Appearance (CAP) Keys simplify answering outside calls.
- If the Absent text message was set by the originating extension, the destination extension displays the assigned text message instead of the Reason for Transfer message.
- If an extension is assigned to a Trunk Access Map that has no access for a trunk, the extension can still retrieve parked calls on that trunk. The extension can also Group Call Pickup and Direct Call Pickup calls ringing another extension on that trunk.
- The system can be programmed to blink the page number of a DT300/DT700 DESI-Less terminal when it receives an incoming call, or switch to the page the incoming call is on. Furthermore, a default page can be defined for the DESI-Less terminal to change to when it goes idle or when it has answered a call.
- DESI-Less screen page switching only applies to idle terminals. If a terminal is not idle, the screen will not switch if another call comes in until the phone goes idle.
- To adjust for proper audio quality, refer to Programs 81-07 and 81-17.

## Default Settings

Enabled

## System Availability

### Terminals

All Terminals

### Required Component(s)

Any Trunk Blade (i.e., GCD-4COTB, GCD-2BRIA, GCD-PRTA, etc.)

## Related Features

- ↳ **Call Forwarding**
- ↳ **Contact Center**
- ↳ **Directed Call Pickup**
- ↳ **Direct Inward Dialing (DID)**
- ↳ **Direct Inward Line (DIL)**
- ↳ **Direct Inward System Access (DISA)**
- ↳ **Do Not Disturb**
- ↳ **Group Call Pickup**
- ↳ **ISDN Compatibility**
- ↳ **Line Preference**
- ↳ **Long Conversation Cutoff**
- ↳ **Night Service**
- ↳ **Programmable Function Keys**
- ↳ **Selectable Display Messaging**
- ↳ **Warning Tone for Long Conversation**

## Guide to Feature Programming

The **Level 1**, **Level 2** and **Level 3** columns indicate the programs that are assigned when programming this feature in the order they are most commonly used. These levels are used with PCPro and WebPro wizards for feature programming.

- Level 1 – these are the most commonly assigned programs for this feature.
- Level 2 – these are the next most commonly assigned programs for this feature.
- Level 3 – these programs are not often assigned and require an expert level working knowledge of the system to be properly assigned.

Program Number	Program Name/Description	Input Data	Default	Level		
				1	2	3
10-03-XX	<b>ETU Setup</b> Use program 10-03-XX to setup and confirm the basic configuration data for each blade. This program represents different data depending on the blade installed in the slot. Please refer the SV9100 Programming Manual for a more detailed description of this program.	The assigned data varies depending on the blade installed in the slot.	Refer to the Programming Manual for default values.		✓	
11-11-13	<b>Service Code Setup (for Setup/Entry Operation) – Display Language Selection for Multiline Terminal</b> Select the service code which can be used at an extension to change the displayed language on a multiline terminal display.	MLT 0 ~ 9, *, # Maximum of eight digits	678		✓	
11-11-20	<b>Service Code Setup (for Setup/Entry Operation) – Change Incoming CO and ICM Ring Tones</b> Customize the change incoming CO and ICM ring tones used for registration and setup.	MLT 0 ~ 9, *, # Maximum of eight digits	720		✓	
11-11-21	<b>Service Code Setup (for Setup/Entry Operation) – Check Incoming Ring Tones</b> Check incoming ring tones used for registration and setup.	MLT 0 ~ 9, *, # Maximum of eight digits	711		✓	
11-12-30	<b>Service Code Setup (for Service Access) – Specified Trunk Answer</b> If required, redefine the service code used to answer a specific trunk which is either ringing or on hold.	MLT, SLT 0 ~ 9, *, # Maximum of eight digits	672		✓	
14-01-02	<b>Basic Trunk Data Setup – Transmit Level</b> Customize the transmit and receive levels of the CODEC Gain Types for each trunk.	Trunks 1 ~ 400 1 ~ 57 (-15.5 ~ +12.5dB in 0.5dB intervals)	32 (0dB)		✓	
14-01-03	<b>Basic Trunk Data Setup – Receive Level</b> Customize the transmit and receive levels of the CODEC Gain Types for each trunk.	Trunks 1 ~ 400 1 ~ 57 (-15.5 ~ +12.5dB in 0.5dB intervals)	32 (0dB)		✓	

Program Number	Program Name/Description	Input Data	Default	Level		
				1	2	3
14-02-02	<b>Analog Trunk Data Setup – Ring Detect Type</b> Set Extended Ring Detect or Immediate Ring Detect for the trunk. For T1 loop/ground start trunks, this option must be set to 1 for the trunks to ring and light correctly.	Trunks 1 ~ 400 0 = Normal/delayed 1 = Immediate Ringing	1		✓	
14-05-01	<b>Trunk Group – Trunk Group Number</b> Assign trunks to trunk groups then go to Program 14-06-01 below to set up Trunk Group Routing.	Trunk Port 1 ~ 400 Group Number 0 ~ 100 Priority 1 ~ 400	Default = Trunks 1 - 400 assigned to trunk group 1 with priorities equal to the trunk number. Trunk 1 = Priority 1 Trunk 400 = Priority 400.		✓	
14-06-01	<b>Trunk Group Routing – Priority Order Number</b> Set the priority order number 1 ~ 4.	0 = Not Set 001 ~ 100 = Trunk group No. 101 ~ 150 = 100 + Networking System No. 1001 ~ 1100 = 1000 + Route Table No.	Route 1, Order Number 1 = 1 (Trunk Group 1) Order Numbers 2, 3, 4 = 0 (Not Specified) All Other Routes (2 ~ 100) and Order Numbers (1 ~ 4) = 0 (Not Specified).		✓	
14-07-01	<b>Trunk Access Map Setup</b> Set up the Trunk Access Maps. This sets the access options for trunks. Ring Group programming overrides Access Map programming.	0 = No access 1 = Outgoing access only 2 = Incoming access only 3 = Access only when trunk on Hold 4 = Outgoing access and access when trunk on Hold 5 = Incoming access and access when trunk on Hold 6 = Incoming and Outgoing access 7 = Incoming access, outgoing access and access when trunk on Hold Trunk Access Maps: 1 ~ 400	Access Maps 1 ~ 400 = Trunk Ports 1 ~ 400 assigned with option 7 access (incoming and outgoing access and access when trunk is on Hold).		✓	
15-01-05	<b>Basic Extension Data Setup – Restriction for Outgoing Disable on Incoming Line</b> Enable (1)/Disable (0) supervised dial detection for an extension.	0 = No 1 = Yes	0		✓	

Program Number	Program Name/Description	Input Data	Default	Level		
				1	2	3
15-02-01	<b>Multiline Telephone Basic Data Setup – Display Language Selection</b> Select the language to be displayed on a multiline terminal display.	0 = Japanese 1 = English 2 = German 3 = French 4 = Italian 5 = Spanish 6 = Dutch 7 = Portuguese 8 = Norwegian 9 = Danish 10 = Swedish 11 = Turkish 12 = Latin American Spanish 13 = Romanian 14 = Polish	1		✓	
15-02-02	<b>Multiline Telephone Basic Data Setup – Trunk Ring Tone</b> Set the tone (pitch) of the incoming trunk ring for the extension port you are programming.	1 = High 2 = Medium 3 = Low 4 = Ring Tone 1 5 = Ring Tone 2 6 = Ring Tone 3 7 = Ring Tone 4 8 = Ring Tone 5	2		✓	
15-02-22	<b>Multiline Telephone Basic Data Setup – Multiple Incoming From Intercom and Trunk</b> When this option is disabled, incoming calls to an extension indicate on any Hotline key for that extension as solid (busy). When this option is enabled, lighting is determined by the setting of Program 22-01-01 Incoming Call Priority. If set to trunk priority (1), the Hotline key lights solid when a trunk call rings in. If set to intercom priority (0), the Hotline key does not light for incoming trunk calls, but lights solid for intercom calls.	0 = Disable 1 = Enable	1		✓	
15-03-03	<b>Single Line Telephone Basic Data Setup – Terminal Type</b> Enter 1 for this option to allow a single line port to receive DTMF tones after the initial call setup. Enter 0 to have the port ignore DTMF tones after the initial call setup. For Voice Mail, always enter 1 (e.g., receive DTMF tones).	0 = Normal 1 = Special	0		✓	
15-06-01	<b>Trunk Access Map for Extensions</b> Assign Trunk Access Maps to extensions.	Trunk Access Maps: 1 ~ 400	1		✓	

Program Number	Program Name/Description	Input Data	Default	Level		
				1	2	3
15-07-01	<b>Programmable Function Keys</b> Assign functions to multiline terminal line keys.	Line Key 1 ~ 48 0 ~ 99 (Normal Function Code 751 by default) *00 ~ *99 (Appearance Function Code) (Service Code 752 by default)	Refer to the Programming Manual for default values.	✓		
15-25-01	<b>DESI-less Page Setup – Incoming Call Notify Event</b> Enable/Disable the ability of a DESI-Less terminal to blink the page number that has an incoming call on one of the keys.	0 = Disable 1 = Enable	1		✓	
15-25-02	<b>DESI-less Page Setup – Incoming Call Automatic Screen Switching</b> Enable/Disable the ability of a DESI-Less terminal to switch to the page that has an incoming call on one of the keys.	0 = Disable 1 = Enable	1		✓	
15-25-03	<b>DESI-less Page Setup – Idle Automatic Screen Switching</b> Define or Disable the page to be automatically displayed when a DESI-Less terminal becomes idle.	0 = Disable 1 = Display page 1 2 = Display page 2 3 = Display page 3 4 = Display page 4	0		✓	
15-25-04	<b>DESI-less Page Setup – Answer Automatic Screen Switching</b> Define or Disable the page to be automatically displayed when a DESI-Less terminal answers a call.	0 = Disable 1 = Display page 1 2 = Display page 2 3 = Display page 3 4 = Display page 4	0		✓	
20-02-09	<b>System Options for Multiline Telephones – Disconnect Supervision</b> Enable/Disable disconnect supervision for the system trunks.	0 = Disable 1 = Enable	1		✓	
20-02-15	<b>System Options for Multiline Telephones – Caller ID Display Mode</b> Define the Caller ID display mode for multiline terminals.	0 = Name and Number (Both) 1 = Name 2 = Number	0		✓	
20-06-01	<b>Class of Service for Extensions</b> Assign a Class of Service (1 ~ 15) to extensions.	Day Night/Mode: 1 ~ 8 Class of Service of Extensions (1 ~ 15)	Extension port 101 = Class 15 All other extension port = Class 1		✓	
20-10-07	<b>Class of Service Options (Answer Service) – Automatic Off-Hook Answer</b> Turn Off or On an extension user ability to use Universal Auto Answer (no service code required).	0 = Off 1 = On	COS 1 ~ 15 = 0		✓	



Program Number	Program Name/Description	Input Data	Default	Level		
				1	2	3
20-13-13	<b>Class of Service Options (Supplementary Service) – Continued Dialing (DTMF) Signal on ICM Call</b> Turn Off or On an extension user ability to use Continued Dialing, which allows DTMF signal sending while talking on extension.	0 = Off 1 = On	COS 1 ~ 15 = 1		✓	
20-13-23	<b>Class of Service Options (Supplementary Service) – Display the Reason for Transfer</b> Select whether or not an extension should display the reason a call is being transferred to their extension (Call Forward Busy, Call Forward No Answer, DND).	0 = Off 1 = On	COS 1 ~ 15 = 0		✓	
21-01-15	<b>System Options for Outgoing Calls – Outgoing Disable on Incoming Line (Toll Restriction)</b> Enable/Disable the Outgoing Disable on Incoming Line feature.	0 = Disable (Off) 1 = Enable (On)	0		✓	
21-01-16	<b>System Options for Outgoing Calls – Supervise Dial Detection Timer</b> With the Outgoing Disable on Incoming Line feature, if dial tone is not detected after the extension answers an incoming line, the system determines the call is unable to complete and releases the DTMF receiver.	0 ~ 64800 seconds	20		✓	
21-01-17	<b>System Options for Outgoing Calls – Restriction Digit in Outgoing Disable on Incoming Line</b> With the Outgoing Disable on Incoming Line feature, determine the number of digits to be dialed before the call should be disconnected.	Digits 1 ~ 9	4		✓	
22-01-01	<b>System Options for Incoming Calls – Incoming Call Priority</b> Determine if Intercom calls or trunk calls have answer priority when both are ringing simultaneously.	0 = Intercom call priority 1 = Trunk call priority	1		✓	
22-01-02	<b>System Options for Incoming Calls – Incoming Call Ring No Answer Alarm</b> Enable/Disable the Incoming Call RNA Alarm. If enabled, the ring cadence changes for a call that rings longer than the interval set in Program 22-01-03.	0 = Disable 1 = Enable	0		✓	
22-01-03	<b>System Options for Incoming Calls – Ring No Answer Alarm Time</b> Set the Ring No Answer Alarm time. If a trunk rings a multiline terminal longer than this time, the system changes the ring cadence.	0 ~ 64800 seconds	60		✓	

Program Number	Program Name/Description	Input Data	Default	Level		
				1	2	3
22-01-04	<p><b>System Options for Incoming Calls – DIL No Answer Recall Time</b></p> <p>A DIL that rings its programmed destination longer than this interval diverts to the DIL No Answer Ring Group (set in Program 22-08).</p>	<p>0 ~ 64800 seconds</p> <p>0 = No Overflow</p>	0		✓	
22-02-01	<p><b>Incoming Call Trunk Setup</b></p> <p>Set the feature type for the trunk you are programming.</p>	<p>Trunks 1 ~ 400</p> <p>0 = Normal</p> <p>1 = VRS (second dial tone if no VRS installed)</p> <p>2 = DISA</p> <p>3 = DID</p> <p>4 = DIL</p> <p>5 = E&amp;M Tie line</p> <p>6 = Delayed VRS</p> <p>7 = ANI/DNIS</p> <p>8 = DID(DDI) Mode Switching</p>	0		✓	
22-03-01	<p><b>Trunk Ring Tone Range – Ring Tone Pattern</b></p> <p>Assign Ring Tone Ranges to trunks. Trunks ring extensions according to the Ring Tone Range selected in Program 22-03-0 and the settings made with either Service Code 720 or Program 15-02-02.</p>	<p>0 = Ring Tone Pattern 1</p> <p>1 = Ring Tone Pattern 2</p> <p>2 = Ring Tone Pattern 3</p> <p>3 = Ring Tone Pattern 4</p> <p>4 = Melody 1</p> <p>5 = Melody 2</p> <p>6 = Melody 3</p> <p>7 = Melody 4</p> <p>8 = Melody 5</p> <p>9 = Ring Tone Pattern 5</p> <p>10 = Ring Tone Pattern 6</p> <p>11 = Ring Tone Pattern 7</p> <p>12 = Ring Tone Pattern 8</p>	0		✓	
22-04-01	<p><b>Incoming Extension Ring Group Assignment</b></p> <p>Assign extensions (up to 48) to Ring Groups. Calls ring extensions according to Ring Group programming. There are 100 available ring groups.</p>	Maximum of eight digits.	Extensions 101 ~ 108 (first eight ports) ring for incoming Ring Group 1 calls. No other extensions ring for incoming Ring Group 1 calls.		✓	
22-05-01	<p><b>Incoming Trunk Ring Group Assignment</b></p> <p>To have the trunks ring extensions, assign trunks to a Ring Group. The incoming ring group assignment programmed in Program 41-03-01 overrides the setting in this program.</p>	<p>Trunks 1 ~ 400</p> <p>Incoming Group Number for Day/Night Mode (1 ~ 8):</p> <p>0 = (No Setting)</p> <p>001 ~ 100 = (Incoming Group)</p> <p>102 = (In-Skin/ External Voice Mail or InMail)</p>	1		✓	

Program Number	Program Name/Description	Input Data	Default	Level		
				1	2	3
22-06-01	<b>Normal Incoming Ring Mode</b> Indicate whether the trunks in the Ring Group assigned in Program 22-04-01 should ring or not ring.	0 = No Ring 1 = Ring	1		✓	
22-07-01	<b>DIL Assignment</b> Assign the destination extension for each DIL incoming trunk (001~400). ➡ For this selection to work, set Program 22-02-01 to 4 (DIL).	Day/Night Modes (1 ~ 8): Extension Number (maximum of eight digits) Pilot Number	No Setting		✓	
22-08-01	<b>DIL/IRG No Answer Destination</b> If an incoming trunk call rings longer than the DIL No Answer Time (Program 22-01-04), it routes to the destination you specify in this option. Determine if the destination should be a Ring Group, In-Skin/External Voice Mail, or Central Voice Mail.	0 = (No Setting) 001 ~ 100 = Incoming Ring Group 102 = (In-Skin/ External Voice Mail or InMail)	1		✓	
23-03-01	<b>Universal Answer/Auto Answer</b> Use this program to let an extension user automatically answer trunk calls that ring other extensions. When the user lifts the handset, they automatically answer the ringing calls based on Trunk Group Routing programming (defined in Program 14-06).	Day/Night Mode 1 ~ 8 Route Table Number 0 ~ 100	0		✓	
82-08-01	<b>Sidetone Volume Setup</b> Adjust of the multiline terminal side tone volume. There are two levels, based on whether the connected trunk is a digital trunk or analog trunk.	Input Data (Digital Sidetone Level: Analog Sidetone Level) 0 (-54 dB : -54 dB) 1 (-48 dB : -54 dB) 2 (-42 dB : -54 dB) 3 (-36 dB : -48 dB) 4 (-30 dB : -42 dB) 5 (-24 dB : -36 dB) 6 (-18 dB : -30 dB) 7 (-12 dB : -24 dB) 8 (-12 dB : -18 dB) 9 (-12 dB : -12 dB)	6		✓	

## Operation

### To answer an incoming trunk call:

1. Lift the handset.

### To use Universal Answer to answer a call ringing over the Paging system:

1. Go off-hook.
  - ◇ Depending on system programming, this may answer the call and you can skip Step 2.

2. Dial **#0**.
  - ◇ *If you hear error tone, your extension Class of Service prevents Universal Answer.*

**To listen to the incoming trunk ring choices:**

1. Press **Speaker**.
2. Dial **711 + 2**.
3. Select the ringing (**1~8**) and tone range (**1~4**) you want to check.
4. Go back to step 3 to listen to additional choices or press **Speaker** to hang up.

**To change the ringing of your incoming trunk:**

1. Press **Speaker**.
2. Dial **720 + 2**.
3. Select the ringing (**1~8**).
4. Press **Speaker** to hang up.

## Central Office Calls, Answering – Auto Attendant Enhancement

### Description

With Version 5000 or higher, Attendant Message number can be used as an index to set the transfer destination for Wrong Dialing/Dial Tone Timeout and No Answer/Busy.

#### Conditions

- Auto Attendant Enhancement is supported with VRS, DISA, DID, DID Mode Switching Trunks.
- For Wrong Dialing/Dial Tone Timeout, if Program 25-17-01 is set to default (0), then Program 25-03 is used and Program 25-07-01 timer is followed.
- For No Answer/Busy if Program 25-17-02 is set to default (0), then Program 25-04 is used and Program 25-07-02 timer is followed. Also, if Program 20-30 timer class for trunk is set then Program 20-31-17 is used.
- When using Program 25-03/04, Disconnect after transfer to IRG timer defined in Program 25-07-03 is followed. Also, if Program 20-30 timer class for trunk is set then Program 20-31-18 is used.
- When Program 25-17 is used, the timer defined in Program 25-18 is followed.
- When an analog trunk is used and the dialed extension is busy, the call is not transferred per Program 25-17-02 if Program 40-10-01 is enabled.

#### Default Settings

None

### System Availability

#### Terminals

All Terminals

#### Required Component(s)

0415 – SV9100 Version Lic (R5)

### Related Features

➔ **Direct Inward Dialing (DID)**

- ➔ **Direct Inward System Access (DISA)**
- ➔ **Voice Response System (VRS)**

## Guide to Feature Programming

The **Level 1**, **Level 2** and **Level 3** columns indicate the programs that are assigned when programming this feature in the order they are most commonly used. These levels are used with PCPro and WebPro wizards for feature programming.

- Level 1 – these are the most commonly assigned programs for this feature.
- Level 2 – these are the next most commonly assigned programs for this feature.
- Level 3 – these programs are not often assigned and require an expert level working knowledge of the system to be properly assigned.

Program Number	Program Name/Description	Input Data	Default	Level		
				1	2	3
25-02-01	<b>DID/DISA VRS Message</b> For each trunk port and each night mode, select the message source (0 = No Message, 1 = VRS, 2 = ACI, 3 =S LT), assign the VRS message number to be used as the Automated Attendant Message for each trunk, which is assigned as VRS/DISA [with VRS = 01 ~ 48 (VRS message number), with ACI = 1 ~ 4 or 01 ~ 16 (ACI group number), with SLT = 1 ~ 8 or 01 ~ 64 (Department Group number)].	0 = No Message 1 = VRS (01 ~ 100 VRS Message Number) 2 = ACI (01 ~ 04 ACI Group Number) 3 = Department Groups (01 ~ 64 Extension Group Number)	0	✓		
25-17-01	<b>VRS/DISA Attendant Message Service Setup – Transfer Ring Group at Wrong Dialing</b> Set the transfer destination for VRS, DID, DISA and DID mode switching Trunk. The destination can be a Ring Group, Voice Mail or Speed dial.	Attendant Message Number (1~100) 0 = Refer PRG 25-03 1 ~ 100 = Incoming Ring Group 102 = In-Skin/External Voice Mail or InMail 104 = Speed Dial Bin (Program 25-17-03)	0	✓		
25-17-02	<b>VRS/DISA Attendant Message Service Setup – Transfer Ring Group at No Answer/Busy</b> Set the transfer destination for VRS, DID, DISA and DID mode switching Trunk. The destination can be a Ring Group or Voice Mail and Speed dial.	Attendant Message Number (1~100) 0 = Refer PRG 25-04 1 ~ 100 = Incoming Ring Group 102 = In-Skin/External Voice Mail or InMail 104 = Speed Dial Bin (Program 25-17-04)	0	✓		
25-17-03	<b>VRS/DISA Attendant Message Service Setup – Transfer Target Area at Wrong Dialing</b> Assign a speed dial bin target number for wrong dialing/Dial tone timeout.	0 ~ 9999	9999	✓		

Program Number	Program Name/Description	Input Data	Default	Level		
				1	2	3
25-17-04	<b>VRS/DISA Attendant Message Service Setup – Transfer Target Area at No Answer or Busy</b> Assign a speed dial bin target number for the target extension no answer or busy.	0 ~ 9999	9999	✓		
25-18-01	<b>VRS/DISA Attendant Message Timer Setup – Dial Tone</b> After answering a VRS/DISA trunk, the system waits this time for the caller to dial the first digit.	0 ~ 64800	10	✓		
25-18-02	<b>VRS/DISA Attendant Message Timer Setup – No Answer Time</b> A VRS/DISA caller can ring an extension for this time before the system sets the call as a Ring No Answer.	0 ~ 64800	0	✓		
25-18-03	<b>VRS/DISA Attendant Message Timer Setup – Disconnect After VRS/DISA Retransfer to IRG</b> From VRS/DISA trunk, when the call may go to Incoming Ring Group (IRG) or speed dial of Program 25-17-02. This setting determines the time the call is ringing in the IRG or speed dial.	0 ~ 64800	60	✓		

## Operation

Call Flow Chart:

Figure 2-2 Auto Attendant Enhancement Flowchart 1

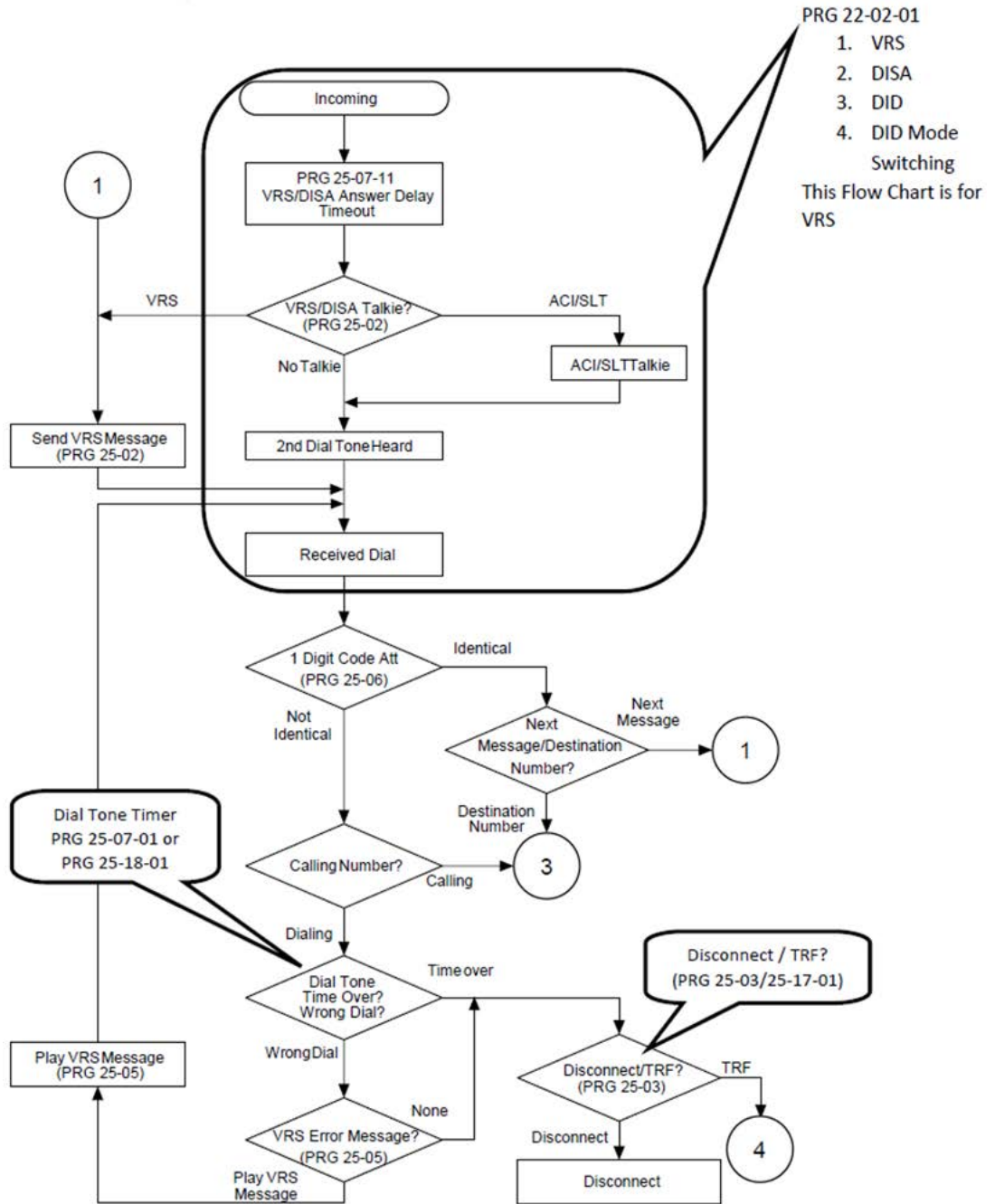
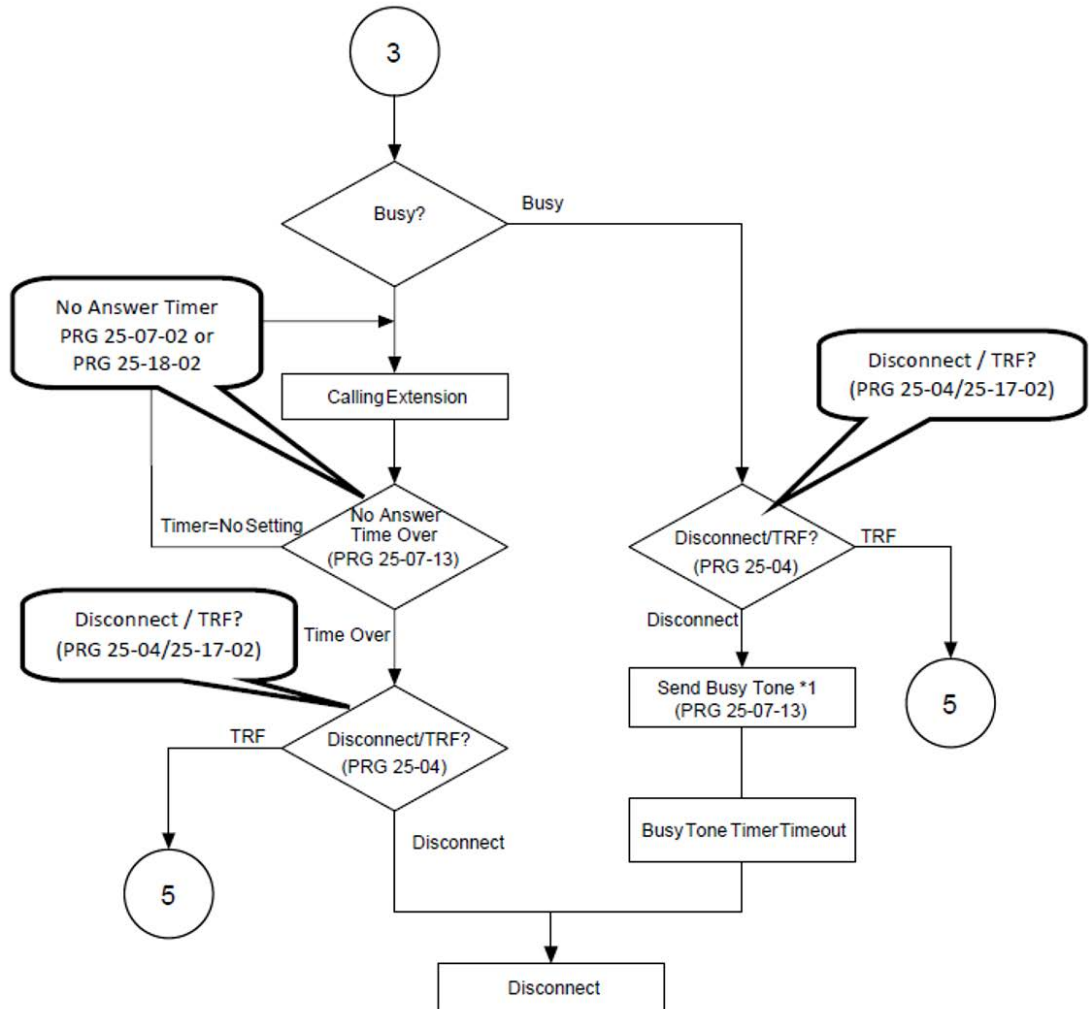



Figure 2-3 Auto Attendant Enhancement Flowchart 2



Note: In case when Analog DID is used and calling extension is not busy, call will not transfer as per PRG 25-17-02/25-04 after expiring of timer define in PRG 25-18-02/25-07-02. And also call is not disconnected if no value is set in PRG 25-17-02/25-04

\*1 Disconnect: ISDN and SIP  
 \*1 In case of analog DID, call will not disconnect after timer defined in PRG 25-07-13 expires, a Busy tone is heard continuously.

Figure 2-4 Auto Attendant Enhancement Flowchart 3

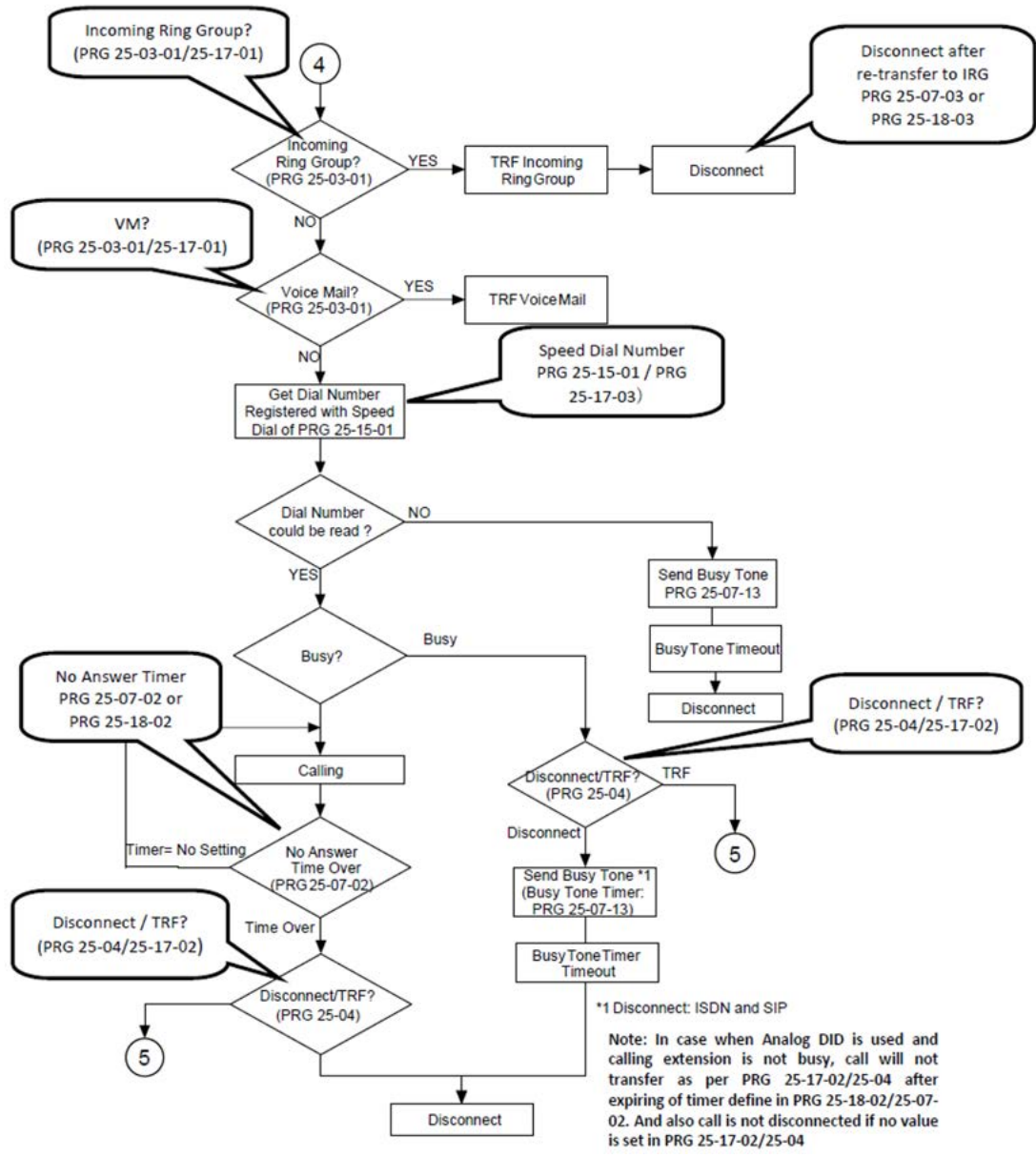
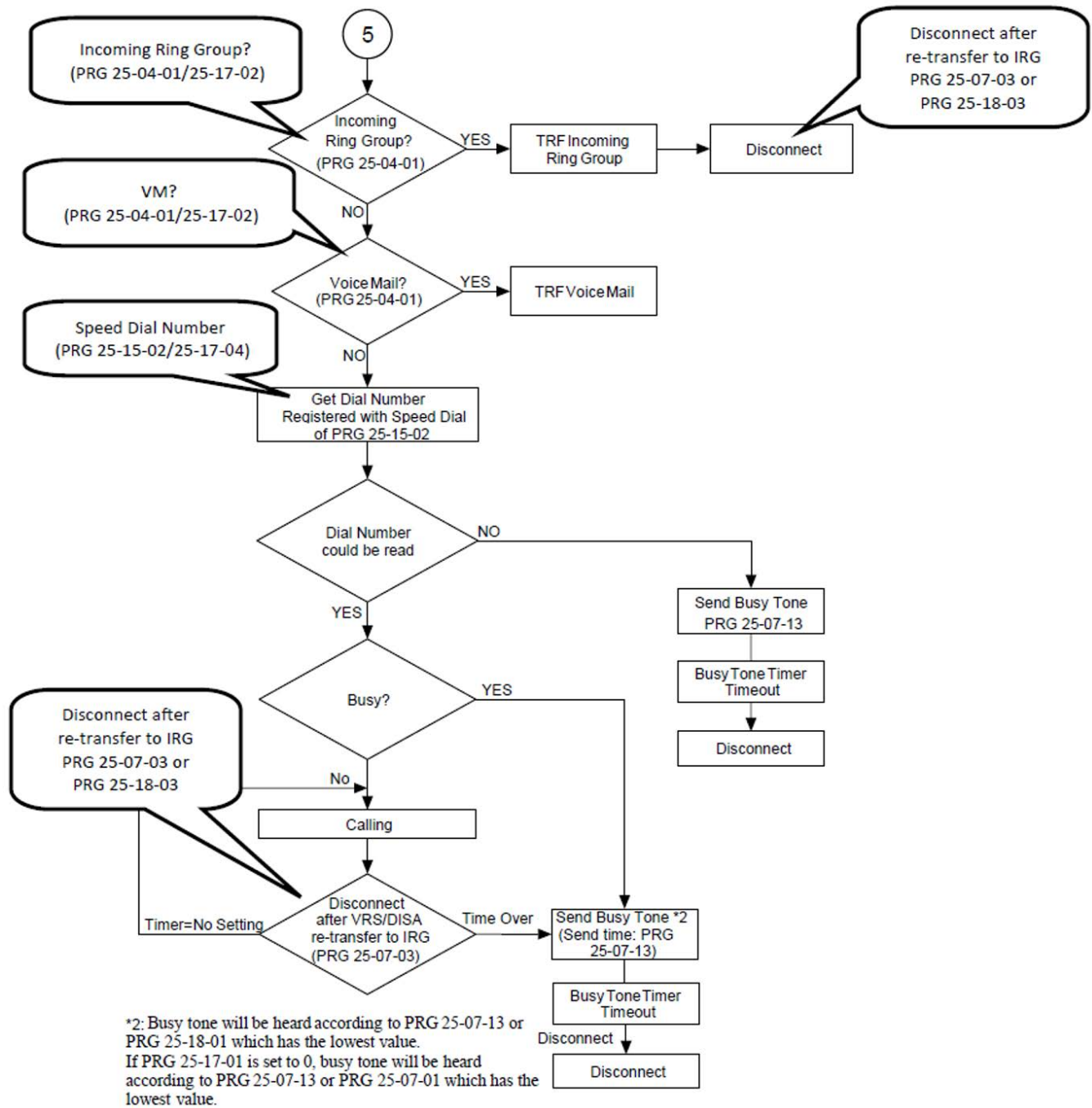

Figure 2-5 Auto Attendant Enhancement Flowchart 4



## Central Office Calls, Answering – Playing MOH During VRS/DISA Transfer

### Description

With version 5000 or higher, Ring Back Tone or MOH to external caller can be chosen during VRS/DISA transfer of an incoming trunk call. With this enhancement, Sub MOH source (Program 10-04-04) which is different from Program 10-04-01 can be selected for playing MOH during VRS/DISA Transfer.

Figure 2-6 VRS/DISA Transfer to Extension

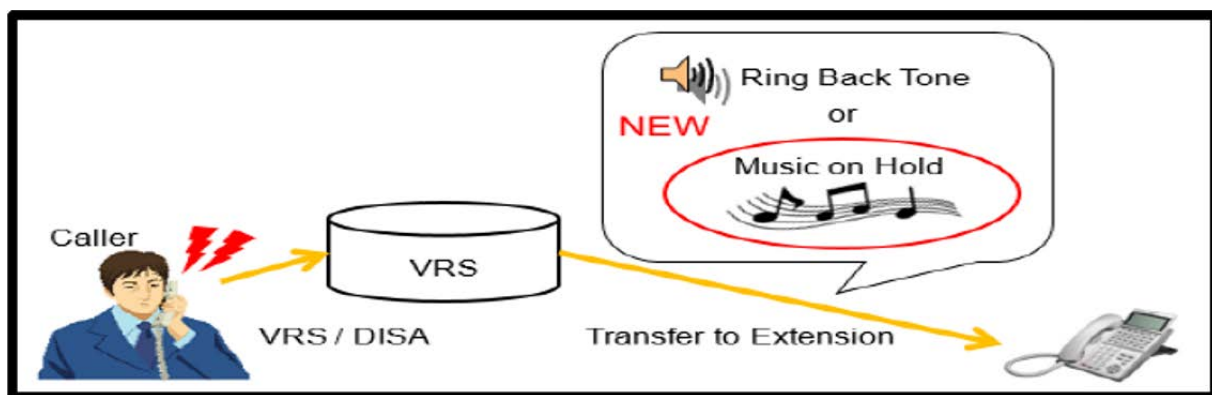

### Conditions

- The following types of transfer by VRS/DISA are supported.
  - ❑ Transfer at additional dialing.
  - ❑ Transfer at one digit dialing (Program 25-06-02).
  - ❑ Transfer to ring group at wrong dialing (Program 25-03-01).
  - ❑ Transfer to ring group at no answer/busy (Program 25-04-01).
- Sub MOH, which is the different MOH Tone from MOH IC/External (Program 10-04-01), can be selected.
- Inbound tone as RBT or MOH during VRS/DISA transfer is chosen for every TRUNK port by Program 25-01-04.
- One VRS channel is used when a VRS message is used as MOH. Only one VRS channel is used even if a VRS message as MOH is used for multiple trunks at the same time.
- Only one MOH source is possible with the SV9100 system. There may be a case where MOH is started playing from the middle of the music, if it is used by multiple trunks at the same time.

- Selected VRS/DISA transfer tones are played as per following flow chart:

Figure 2-7 Playing MOH During VRS/DISA Transfer – Flow Chart

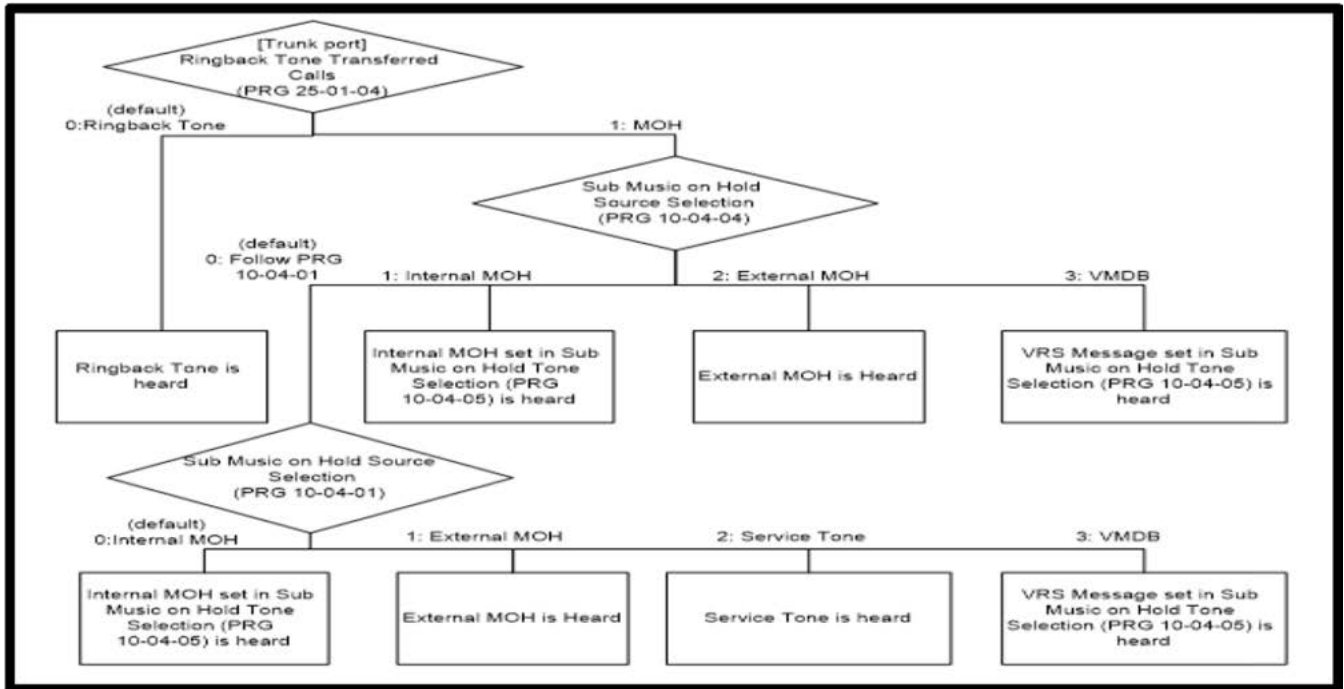

- A VRS message can't be played if the following occurs:
  - ❑ There are no VRS sound files.
  - ❑ The file can not be accessed (It's being recorded and erased.)
- If Program 10-04-01 is set to **VMDB**, but the VRS message that is set in Program 10-04-02 can't be played, the tone set in Program 10-04-04 is heard using the following conditions:
  - ❑ If Program 10-04-04 is set to **0** (Follow PRG 10-04-01), the Internal MOH **Download File1** is heard.
  - ❑ If Program 10-04-04 is set to **1** (Internal MOH), the Internal MOH set in Program 10-04-05 is heard.
  - ❑ If Program 10-04-04 is set to **2** (External MOH), the External MOH is heard.
- If Program 10-04-04 is set to **VMDB**, but the VRS message that is set in Program 10-04-05 can't be played, the tone set in Program 10-04-01 is heard using the following conditions:
  - ❑ If Program 10-04-01 is set to **0** (Internal), the Internal MOH set in Program 10-04-02 is heard.
  - ❑ If Program 10-04-01 is set to **1** (External), the External MOH is heard.
  - ❑ If Program 10-04-01 is set to **2** (Service Tone), no tone is heard.

- If Program 10-04-04 is set, and the user tries to change Program 10-04-01, after applying the settings both programs are changed to the following:

Table 2-10 Editing Program 10-04-04

Before Setting	Setting Value	After Setting	
PRG 10-04-04	PRG 10-04-01	PRG 10-04-04	PRG 10-04-01
0: Follow PRG 10-04-01	0: Internal	0: Follow PRG 10-04-01	0: Internal
	1: External	0: Follow PRG 10-04-01	1: External
	2: Service Tone (Overseas Only)	0: Follow PRG 10-04-01	2: Service Tone (Overseas Only)
	3: VMDB	0: Follow PRG 10-04-01	3: VMDB
1: Internal MOH	0: Internal	0: Follow PRG 10-04-01	0: Internal
	1: External	0: Follow PRG 10-04-01	1: External
	2: Service Tone (Overseas Only)	1: Internal MOH	2: Service Tone (Overseas Only)
	3: VMDB	1: Internal MOH	3: VMDB
2: External MOH	0: Internal	0: Follow PRG 10-04-01	0: Internal
	1: External	0: Follow PRG 10-04-01	1: External
	2: Service Tone (Overseas Only)	2: External MOH	2: Service Tone (Overseas Only)
	3: VMDB	2: External MOH	3: VMDB
3: VMDB	0: Internal	3: VMDB	0: Internal
	1: External	3: VMDB	1: External
	2: Service Tone (Overseas Only)	3: VMDB	2: Service Tone (Overseas Only)
	3: VMDB	0: Follow PRG 10-04-01	3: VMDB

- If Program 10-04-01 is set, and the user tries to change Program 10-04-04, after applying the settings both programs are changed to the following:

Table 2-11 Program 10-04-01 Settings

Before Setting	Setting Value	After Setting	
PRG 10-04-01	PRG 10-04-04	PRG 10-04-01	PRG 10-04-04
0: Internal	0: Follow PRG 10-04-01	0: Internal	0: Follow PRG 10-04-01
	1: Internal MOH	0: Internal	Not changed (Duplicate Error)
	2: External MOH	0: Internal	Not changed (Duplicate Error)
	3: VMDB	0: Internal	3: VMDB
1: External	0: Follow PRG 10-04-01	1: External	0: Follow PRG 10-04-01
	1: Internal MOH	1: External	Not changed (Duplicate Error)
	2: External MOH	1: External	Not changed (Duplicate Error)
	3: VMDB	1: External	3: VMDB
2: Service Tone (Overseas Only)	0: Follow PRG 10-04-01	2: Service Tone	0: Follow PRG 10-04-01
	1: Internal MOH	2: Service Tone	1: Internal MOH
	2: External MOH	2: Service Tone	2: External MOH
	3: VMDB	2: Service Tone	3: VMDB
3: VMDB	0: Follow PRG 10-04-01	3: VRS 3: VMDB	0: Follow PRG 10-04-01
	1: Internal MOH	3: VRS 3: VMDB	1: Internal MOH
	2: External MOH	3: VRS 3: VMDB	2: External MOH
	3: VMDB	3: VRS 3: VMDB	Not changed (Duplicate Error)

- If using VRS/DISA transfer in a Netlink system, the BGM/External MOH source connected to the system which has the incoming trunk is used.
- Only one Internal MOH (Music) can be set.
- Only one VRS message number can be set.
- DID transfer is not supported.
- Remote access from DISA is not supported.
- Transfer from DISA Trunk Access is not supported.
- Transfer to an extension in CCIS networking system is not supported.



## Default Settings

None

## System Availability

### Terminals

All Multiline Terminals

### Required Component(s)

0415 – SV9100 Version Lic (R5)

## Related Features

- ➔ **Direct Inward System Access (DISA)**
- ➔ **Voice Response System (VRS)**

## Guide to Feature Programming

The **Level 1**, **Level 2** and **Level 3** columns indicate the programs that are assigned when programming this feature in the order they are most commonly used. These levels are used with PCPro and WebPro wizards for feature programming.

- Level 1 – these are the most commonly assigned programs for this feature.
- Level 2 – these are the next most commonly assigned programs for this feature.
- Level 3 – these programs are not often assigned and require an expert level working knowledge of the system to be properly assigned.

Program Number	Program Name/Description	Input Data	Default	Level		
				1	2	3
10-04-01	<b>Music on Hold Setup – Music on Hold Source Selection</b> Determine whether the system should use Internal MOH, External MOH, Service Tone, or VMDB. If set to 1, Program 14-08-01 must be set to 0 or 1.	0 = Internal MOH 1 = External MOH 2 = Service Tone 3 = VMDB	2	✓		



Program Number	Program Name/Description	Input Data	Default	Level		
				1	2	3
10-04-02	<b>Music on Hold Setup – Music on Hold Tone Selection</b> When Program 10-04-01 is set to Internal MOH, define the music that is played for Music on Hold.	[When Item 1 is 0] 1 = Download File1 2 = Download File2 3 = Download File3 [When Item 1 is 1, 2, or 3] 1 ~ 100 = VRS Message Number	No Setting		✓	
10-04-04	<b>Music on Hold Setup – Sub Music on Hold Source Selection</b> Select the desired Sub Music on Hold Source Selection.	0 = Follow PRG10-04-01 1 = Internal MOH 2 = External MOH 3 = VMDB	0	✓		
10-04-05	<b>Music on Hold Setup – Sub Music on Hold Tone Selection</b> Select the desired Sub Music on Hold Source Selection.	If PRG10-04-04 is set to: <i>1-Internal MOH</i> 0 = No Tone 1 = Download File1 2 = Download File2 3 = Download File3  If PRG10-04-04 is set to: <i>3-VMDB</i> 0 =No Tone (1-100) = VRS Message Number	0		✓	
25-01-04	<b>VRS/DISA Line Basic Setup – VRS/DISA Transfer Tone</b> Select VRS/DISA Transfer Tone as Inbound Tone sent to external caller while the VRS/DISA call is transferred.	0 = Ring Back Tone 1 = MOH	0		✓	

## Operation

None

## Central Office Calls, Placing

### Description

The system provides flexibility in the way each extension user can place outgoing trunk calls. This lets you customize the call placing options to meet site requirements and each individual's needs. To place a call the user can:

- Press Line Keys
- Press a Trunk Group Key
- Press a Trunk Group Routing (dial 9) Key
- Dial a code for a specific trunk (#9 + the trunk number)
- Dial a code for a Trunk Group (704 + group number)
- Dial a code for Trunk Group Routing or ARS (9)
- Dial an Alternate Trunk Route Access Code (which you must define)
- Press or Use a Speed Dial bin



NOTE

*There are 400 available trunks.*

### Trunk Port Disable

The system provides a service code (default: 645) which can be used by an extension user to block a trunk for outgoing calls. The user which busied out the trunk still has access to it. All other users are blocked from seizing it to place an outgoing call. The trunk, however, can still be answered by any user programmed with the trunk access.

### Sidetone Volume Setup

Allows the system programming for the multiline terminal side tone volume. There are two levels, based on whether the connected trunk is a digital trunk or analog trunk.

### Side Tone Auto Setup

Per each analog trunk (or all analog trunks) the most suitable Codec Filter setting for Program 81-07 and Program 81-17 can be automatically adjusted using Programs 90-68-01 and 90-68-02.

During the trunk measurement process, the following LCD indications are provided:

- During measurement: Measurement (x/4)  
x = number of measurements
- Measure complete: Complete  
Error condition: Error  
Trunk busy: Busy

After successful measurement, the option to copy the same settings to all analog trunks is shown.



NOTE

*Side Tone Auto Setup available when the system is in an idle condition.*

## Conditions

- If the trunk name seize display is enabled in programming, the Call Timer starts automatically after the user places a trunk call. Disabling the trunk name seize display also disables the Call Timer.
- The system can automatically select the correct line to use based on the number dialed and the time.
- With Automatic Handsfree, an extension user can press a line key to place a trunk call without lifting the handset or pressing Speaker. Users without Automatic Handsfree can preselect a line key before lifting the handset or pressing Speaker.
- Long Conversation Cutoff can disconnect incoming and outgoing CO calls after a set time. Using the Warning Tone for Long Conversation feature allows users on outgoing calls to hear a warning tone prior to the call disconnecting.
- An extension Toll Class of Service may prevent dialing certain numbers.
- Dialing 9 or any other trunk access code after dialing an extension, terminates the intercom call and seizes a trunk.
- Phones that have an APR/APA installed do not pass voice to a trunk until the interdigit time expires (Program 21-01-03).
- Setting Program 14-02-11 to On may cause a slight delay in dial tone while loop current is returned.
- When Account Codes are enabled, the user must press the \* three times before the \* character is passed to the telco. The system recognizes the initial \* as the beginning of an Account Code entry, the second \* as the end of an Account Code entry, and the third \* will be passed to telco.
- To adjust for proper audio quality, refer to Programs 81-07 and 81-17.

## Default Settings

Enabled

## System Availability

### Terminals

All Multiline Terminals

### Required Component(s)

Any Trunk Blade (i.e., GCD-4COTB, GCD-2BRIA, GCD-PRTA, etc.)

### Related Features

- ➔ **Alphanumeric Display**
- ➔ **Automatic Route Selection (ARS)**
- ➔ **Call Appearance (CAP) Keys**
- ➔ **Code Restriction**
- ➔ **Dial Tone Detection**
- ➔ **Handsfree Answerback/Forced Intercom Ringing**
- ➔ **Long Conversation Cutoff**
- ➔ **Microphone Cutoff**
- ➔ **Programmable Function Keys**
- ➔ **Trunk Groups**
- ➔ **Trunk Group Routing**

### Guide to Feature Programming

The **Level 1**, **Level 2** and **Level 3** columns indicate the programs that are assigned when programming this feature in the order they are most commonly used. These levels are used with PCPro and WebPro wizards for feature programming.

- Level 1 – these are the most commonly assigned programs for this feature.
- Level 2 – these are the next most commonly assigned programs for this feature.
- Level 3 – these programs are not often assigned and require an expert level working knowledge of the system to be properly assigned.

Program Number	Program Name/Description	Input Data	Default	Level		
				1	2	3
10-03-XX	<b>ETU Setup</b> Use program 10-03-XX to setup and confirm the basic configuration data for each blade. This program represents different data depending on the blade installed in the slot. Please refer the SV9100 Programming Manual for a more detailed description of this program.	The assigned data varies depending on the blade installed in the slot.	Refer to the Programming Manual for default values.		✓	

Program Number	Program Name/Description	Input Data	Default	Level		
				1	2	3
11-01-01	<b>System Numbering</b> Set system numbering plan.		Refer to the Programming Manual for default values.		✓	
11-09-01	<b>Trunk Access Code</b> If required, change the single-digit Trunk Access Code (normally 9). If you change this code, you must also review the settings in Program 11-01-01 for the new code selected.	Dial (maximum of four digits)	9		✓	
11-09-02	<b>Trunk Access Code – 2nd Trunk Route Access Code</b> Assign the Service Code set up in Program 11-01-01 for Alternate Trunk Route Access.	Dial (maximum of four digits)	No Setting		✓	
11-10-27	<b>Service Code Setup (for System Administrator) – Trunk Port Disable for Outgoing Calls</b> Define the service code which should be used by an extension user to block a trunk from being used for outgoing calls.	MLT, SLT 0 ~ 9, *, # Maximum of eight digits	645		✓	
11-11-13	<b>Service Code Setup (for Setup/Entry Operation) – Display Language Selection for Multiline Terminal</b> Select the service code which can be used at an extension to change the displayed language on a multiline terminal display.	MLT 0 ~ 9, *, # Maximum of eight digits	678		✓	
11-12-01	<b>Service Code Setup (for Service Access) – Bypass Call</b> Define the service code for Activating Call Forwarding/Do Not Disturb Override. This code is available only if you disable the voice mail Single Digit dialing code in Program 11-16-09.	MLT, SLT 0 ~ 9, *, # Maximum of eight digits	707		✓	
11-12-14	<b>Service Code Setup (for Service Access) – Trunk Group Access</b> Define the service code which should be used by an extension user to select outgoing Trunk Group.	MLT, SLT 0 ~ 9, *, # Maximum of eight digits	704		✓	
14-01-01	<b>Basic Trunk Data Setup – Trunk Name</b> Set the names for trunks. The trunk name displays on a multiline terminal for incoming and outgoing calls.	Maximum of 12 Characters	Line 001 Line 002 Line 003 : Line 400		✓	
14-01-02	<b>Basic Trunk Data Setup – Transmit Level</b> Customize the transmit and receive levels of the CODEC Gain Types for each trunk.	Trunks 1 ~ 400 1 ~ 57 (-15.5 ~ +12.5dB in 0.5dB intervals)	32 (0dB)		✓	

Program Number	Program Name/Description	Input Data	Default	Level		
				1	2	3
14-01-03	<b>Basic Trunk Data Setup – Receive Level</b> Customize the transmit and receive levels of the CODEC Gain Types for each trunk.	Trunks 1 ~ 400 1 ~ 57 (-15.5 ~ +12.5dB in 0.5dB intervals)	32 (0dB)		✓	
14-01-07	<b>Basic Trunk Data Setup – Outgoing Calls</b> Allow or Deny outgoing calls on the trunk you are programming.	0 = Deny (No) 1 = Allow (Yes)	1		✓	
14-01-10	<b>Basic Trunk Data Setup – DTMF Tones for Outgoing Calls</b> For each trunk, Enable/Disable the ability to hear the DTMF of the digits dialed when placing the outgoing call.	0 = Disable 1 = Enable	0		✓	
14-02-05	<b>Analog Trunk Data Setup – Dial Tone Detection for Manually Accessed Trunks</b> Enable/Disable dial tone detection for directly accessed trunks. If disabled, the system outdials on the trunks without monitoring for dial tone.	0 = Dial Tone Detection Not Used 1 = Dial Tone Detection Used	0		✓	
14-02-11	<b>Analog Trunk Data Setup – Next Trunk in Rotary if No Dial Tone</b> Enable/Disable the system ability to skip over a trunk if dial tone is not detected. This option pertains to calls placed using Call Appearance (CAP) Keys, Speed Dial, Automatic Route Selection (ARS) (ARS), Last Number Redial or Save Number dialed. It does not pertain to line key or Direct Trunk Access calls.	0 = Disable 1 = Enable	0		✓	
14-02-14	<b>Analog Trunk Data Setup – Loop Start/ Ground Start</b> Select Loop start or Ground start for the trunk.	0 = Disable 1 = Enable	0		✓	
14-05-01	<b>Trunk Group – Trunk Group Number</b> Assign trunks to trunk groups then go to Program 14-06-01 below to set up Trunk Group Routing.	Trunk Port 1 ~ 400 Group Number 0 ~ 100 Priority 1 ~ 400	Default = Trunks 1 ~ 400 assigned to trunk group 1 with priorities equal to the trunk number. Trunk 1 = Priority 1 Trunk 400 = Priority 400.	✓		
14-06-01	<b>Trunk Group Routing – Priority Order Number</b> Set the priority order number 1 ~ 4.	0 = Not Set 001 ~ 100 = Trunk group No. 101 ~ 150 = 100 + Networking System No. 1001 ~ 1100 = 1000 + Route Table No.	Route 1, Order Number 1 = 1 (Trunk Group 1) Order Numbers 2, 3, 4 = 0 (Not Specified) All Other Routes (2 ~ 100) and Order Numbers (1 ~ 4) = 0 (Not Specified).	✓		

Program Number	Program Name/Description	Input Data	Default	Level		
				1	2	3
14-07-01	<p><b>Trunk Access Map Setup</b> Set up the Trunk Access Maps. This sets the access options for trunks. Ring Group programming overrides Access Map programming.</p>	<p>0 = No access 1 = Outgoing access only 2 = Incoming access only 3 = Access only when trunk on Hold 4 = Outgoing access and access when trunk on Hold 5 = Incoming access and access when trunk on Hold 6 = Incoming and Outgoing access 7 = Incoming access, outgoing access and access when trunk on Hold Trunk Access Maps: 1 ~ 400</p>	<p>Access Maps 1 ~ 400 = Trunk Ports 1 ~ 400 assigned with option 7 access (incoming and outgoing access and access when trunk is on Hold).</p>		✓	
15-02-01	<p><b>Multiline Telephone Basic Data Setup – Display Language Selection</b> Select the language to be displayed on a multiline terminal display.</p>	<p>0 = Japanese 1 = English 2 = German 3 = French 4 = Italian 5 = Spanish 6 = Dutch 7 = Portuguese 8 = Norwegian 9 = Danish 10 = Swedish 11 = Turkish 12 = Latin American Spanish 13 = Romanian 14 = Polish</p>	1		✓	
15-02-08	<p><b>Multiline Telephone Basic Data Setup – Automatic Handsfree</b> Set whether pressing a key accesses a One-Touch Key or Preselects the key.</p>	<p>0 = Preselect 1 = One-Touch (Automatic Handsfree)</p>	1		✓	
15-03-03	<p><b>Single Line Telephone Basic Data Setup – Terminal Type</b> Enter 1 for this option to allow a single line port to receive DTMF tones after the initial call setup. Enter 0 to have the port ignore DTMF tones after the initial call setup. For Voice Mail, always enter 1 (e.g., receive DTMF tones).</p>	<p>0 = Normal 1 = Special</p>	0		✓	
15-06-01	<p><b>Trunk Access Map for Extensions</b> Assign Trunk Access Maps to extensions.</p>	<p>Trunk Access Maps: 1 ~ 400</p>	1		✓	

Program Number	Program Name/Description	Input Data	Default	Level		
				1	2	3
15-07-01	<b>Programmable Function Keys</b> Assign functions to multiline terminal line keys.	Line Key 1 ~ 48 0 ~ 99 (Normal Function Code 751 by default) *00 ~ *99 (Appearance Function Code) (Service Code 752 by default)	Refer to the Programming Manual for default values.	✓		
20-02-06	<b>System Options for Multiline Telephones – Preselection Time</b> Set the preselection time When a multiline terminal user preselects a line key, the system remembers the preselection for this time.	0 ~ 64800 seconds	5 seconds		✓	
20-02-09	<b>System Options for Multiline Telephones – Disconnect Supervision</b> Enable/Disable disconnect supervision for the system trunks.	0 = Disable 1 = Enable	1		✓	
20-06-01	<b>Class of Service for Extensions</b> Assign a Class of Service (1 ~ 15) to extensions.	Day Night/Mode: 1 ~ 8 Class of Service of Extensions (1 ~ 15)	Extension port 101 = Class 15 All other extension port = Class 1		✓	
20-07-12	<b>Class of Service Options (Administrator Level) – Trunk Port Disable</b> Turn Off or On an extension ability to use the Trunk Port Disable feature.	0 = Off 1 = On	COS 1 ~ 14= 0 COS 15 = 1		✓	
20-08-02	<b>Class of Service Options (Outgoing Call Service) – Trunk Outgoing Calls</b> Turns Off or On outgoing trunk calling for the extension.	0 = Off 1 = On	COS 1 ~ 15 = 1		✓	
20-13-13	<b>Class of Service Options (Supplementary Service) – Continued Dialing (DTMF) Signal on ICM Call</b> Turn Off or On an extension user ability to use Continued Dialing, which allows DTMF signal sending while talking on extension.	0 = Off 1 = On	COS 1 ~ 15 = 1		✓	
21-01-15	<b>System Options for Outgoing Calls – Outgoing Disable on Incoming Line (Toll Restriction)</b> Enable/Disable the Outgoing Disable on Incoming Line feature.	0 = Disable (Off) 1 = Enable (On)	0		✓	
21-01-16	<b>System Options for Outgoing Calls – Supervise Dial Detection Timer</b> With the Outgoing Disable on Incoming Line feature, if dial tone is not detected after the extension answers an incoming line, the system determines the call is unable to complete and releases the DTMF receiver.	0 ~ 64800 seconds	20		✓	



Program Number	Program Name/Description	Input Data	Default	Level		
				1	2	3
21-01-17	<p><b>System Options for Outgoing Calls – Restriction Digit in Outgoing Disable on Incoming Line</b></p> <p>With the Outgoing Disable on Incoming Line feature, determine the number of digits to be dialed before the call should be disconnected.</p>	Digits 1 ~ 9	4		✓	
21-02-01	<p><b>Trunk Group Routing for Extensions</b></p> <p>Assign Program 14-06 routes to extensions.</p>	0 ~ 100 0 = No Setting (Calls will not route.)	1		✓	
21-15-01	<p><b>Individual Trunk Group Routing for Extensions</b></p> <p>Designate the trunk route accessed when a user dials the Alternate Trunk Route Access Code. Refer to Trunk Group Routing to set up outbound routing.</p>	0 ~ 100 0 = No Setting (Calls will not route.)	0		✓	
24-02-07	<p><b>System Options for Transfer – Trunk-to-Trunk Transfer Release Warning Tone</b></p> <p>Timer starts when a trunk begins talking with another trunk (for example: Trunk-to-Trunk Transfer, outgoing from trunk, Tandem Trunking). When this time expires, a warning tone is heard.</p>	0 ~ 64800 seconds	1800		✓	
24-02-10	<p><b>System Options for Transfer – Disconnect Trunk to Trunk Timer</b></p> <p>Timer starts after the Warning Tone is heard (24-02-07). When time expires, the trunk is disconnected.</p>	0 ~ 64800 seconds	0		✓	
82-08-01	<p><b>Sidetone Volume Setup</b></p> <p>Adjust of the multiline terminal side tone volume. There are two levels, based on whether the connected trunk is a digital trunk or analog trunk.</p>	<p>Input Data (Digital Sidetone Level: Analog Sidetone Level)</p> <p>0 (-54 dB : -54 dB)</p> <p>1 (-48 dB : -54 dB)</p> <p>2 (-42 dB : -54 dB)</p> <p>3 (-36 dB : -48(dB)</p> <p>4 (-30 dB : -42 dB)</p> <p>5 (-24 dB : -36 dB)</p> <p>6 (-18 dB : -30 dB)</p> <p>7 (-12 dB : -24 dB)</p> <p>8 (-12 dB : -18 dB)</p> <p>9 (-12 dB : -12 dB)</p>	6		✓	

## Operation

### To place a call over a trunk group:

1. Go off-hook.
2. Dial **704**.

3. Dial trunk group number (**001~100**).
4. Dial the number.  
- OR -
1. At the multiline terminal, press the **trunk group** key (Program 15-07-01 or SC 751: \*02 + group).
2. Dial the number.

#### To place a call using Trunk Group Routing:

1. Go off-hook.
2. Dial **9**.  
◇ *If your system has an Alternate Trunk Route Access code, you may dial that instead.*
3. Dial the number.  
- OR -
1. At the multiline terminal, press the **Trunk Group Routing** key (Program 15-07-01 or SC 752: \*02 plus trunk group).
2. Dial the number.

#### To place a call over a specific trunk:

1. Dial **#9**.
2. Dial the line number (e.g., 005 for line 5).
3. Dial the number.  
- OR -
1. At the multiline terminal, press line key (Program 15-07-01 or SC 752: \*01 001 to 400).
2. Dial the number.

#### To busy out a trunk from outbound usage:

1. Press **Speaker + 645 + Trunk Number (001~400) + 1**.  
◇ *The user which busied out the trunk still has access to it. All other users are blocked from seizing it to place an outgoing call. The trunk, however, can still be answered by any user programmed with the trunk access.*

#### To Remove a Trunk from a Busied Out State:

1. Press **Speaker + 645 + Trunk Number (001~400) + 0**.

## Class of Service

### Description

Class of Service (COS) sets various features and dialing options (called items) for extensions. The system allows any number of extensions to share the same Class of Service. An extension can have a different Class of Service for each of the Night Service modes. This lets you program a different set of dialing options for daytime operation, nighttime operation and even during lunch breaks. An extension Class of Service can be changed in system programming or via a Service Code (normally 677). There are 15 available Classes of Service.

### Conditions

- Before assigning a new COS, make sure the new COS matches the old COS or you may enable options, which the extension should not have or remove options, which it should have.
- An extension can have a different Class of Service for each Service mode. At default, the Mode names are assigned as follows:
  - Mode 1 = No setting
  - Mode 2 = Night
  - Mode 3 = Midnight
  - Mode 4 = Rest
  - Mode 5 = Day2
  - Mode 6 = Night2
  - Mode 7 = Midnight2
  - Mode 8 = Rest2
- If a user dials a number not programmed in ARS, Program 26-01-03 determines if the system should route over the trunk group settings defined in Program 21-02 or play an error tone.
- When using ARS Class of Service, with Program 26-01-03 set to (1) "Play Warning Tone", any trunk (except a CCIS trunk) pointed or transferred to a virtual that is Call Forward Off-Premise will not complete. For a virtual to Call Forward Off-Premise, Program 26-01-03 must be set to "Route to trunk group" and the call will follow the trunk group settings of the trunk, assigned in Program 21-03.
- When using ARS Class of Service, with Program 26-01-03 set to (1) "Play Warning Tone", a CCIS trunk pointed or transferred to a virtual that is Call Forward Off-Premise will always follow ARS Class 1 routing properties.

## Default Settings

- The attendant (extension 101) has Class of Service 15 in all Night Service modes. All other extensions have Class of Service 1 in all Night Service modes.

If changing Class of Service via Service Code:

- An extension can use Service Code 677 to change another extension Class of Service (Program 20-13-28 = 1).
- An extension can automatically block another extension attempt to change their Class of Service via Service Code 677 (Program 20-13-28 = 0).
- The default Service Code for this option is 677 (Program 11-11-24 = 677).

## System Availability

### Terminals

All Terminals

### Required Component(s)

None

## Related Features

- ↳ **Night Service**

## Guide to Feature Programming

The **Level 1**, **Level 2** and **Level 3** columns indicate the programs that are assigned when programming this feature in the order they are most commonly used. These levels are used with PCPro and WebPro wizards for feature programming.

- Level 1 – these are the most commonly assigned programs for this feature.
- Level 2 – these are the next most commonly assigned programs for this feature.
- Level 3 – these programs are not often assigned and require an expert level working knowledge of the system to be properly assigned.

Program Number	Program Name/Description	Input Data	Default	Level		
				1	2	3
11-11-24	<b>Service Code Setup (for Setup/Entry Operation) – Change Station Class of Service</b> If required, change the Service Code a user dials to change an extension Class of Service.	MLT 0 ~ 9, *, # Maximum of eight digits	677		✓	
20-06-01	<b>Class of Service for Extensions</b> Assign a Class of Service (1 ~ 15) to extensions.	Day Night/Mode: 1 ~ 8 Class of Service of Extensions (1 ~ 15)	Extension port 101 = Class 15 All other extension port = Class 1	✓		
20-07-01	<b>Class of Service Options (Administrator Level) – Manual Night Service Enabled</b> Turn Off or On an extension ability to manually Switch the Night Mode (Service Code 718). This option must be enabled for an extension to be able to display the Night indication.	0 = Off 1 = On	COS 1 ~ 14 = 0 COS 15 = 1		✓	
20-07-02	<b>Class of Service Options (Administrator Level) – Changing the Music on Hold Tone</b> Turn Off or On an extension user ability to change the Music on Hold tone.	0 = Off 1 = On	COS 1 ~ 14 = 0 COS 15 = 1		✓	
20-07-03	<b>Class of Service Options (Administrator Level) – Time Setting</b> Turn Off or On an extension user ability to set the Time via Service Code 728.	0 = Off 1 = On	COS 1 ~ 15 = 1		✓	
20-07-04	<b>Class of Service Options (Administrator Level) – Storing Speed Dialing Entries</b> Turn Off or On an extension to store System or Group Speed Dialing numbers.	0 = Off 1 = On	COS 1 ~ 15 = 1		✓	
20-07-05	<b>Class of Service Options (Administrator Level) – Set/Cancel Automatic Trunk-to-Trunk Transfer</b> Turn Off or On an extension user ability to use the Trunk-to-Trunk Forwarding service codes.	0 = Off 1 = On	COS 1 ~ 15 = 0		✓	
20-07-06	<b>Class of Service Options (Administrator Level) – Charging Cost Display</b>	0 = Off 1 = On	COS 1 ~ 15 = 0		✓	
20-07-10	<b>Class of Service Options (Administrator Level) – Programmable Function Key Programming (Appearance Level)</b> Turn Off or On an extension user ability to program the Appearance function keys using Service Code 752.	0 = Off 1 = On	COS 1 ~ 15 = 1		✓	

Program Number	Program Name/Description	Input Data	Default	Level		
				1	2	3
20-07-11	<b>Class of Service Options (Administrator Level) – Forced Trunk Disconnect (analog trunk only)</b> Turn Off or On an extension user ability to use Forced Trunk Disconnect. This allows the extension to disconnect an Unsupervised Conference in progress.	0 = Off 1 = On	COS 1 ~ 14 = 0 COS 15 = 1		✓	
20-07-12	<b>Class of Service Options (Administrator Level) – Trunk Port Disable</b> Turn Off or On an extension user ability to use the Trunk Port Disable feature.	0 = Off 1 = On	COS 1 ~ 14 = 0 COS 15 = 1		✓	
20-07-13	<b>Class of Service Options (Administrator Level) – VRS Record (VRS Msg Operation)</b> Turn Off or On an extension user ability to record, erase and listen to VRS messages.	0 = Off 1 = On	COS 1 ~ 14 = 0 COS 15 = 1		✓	
20-07-14	<b>Class of Service Options (Administrator Level) – VRS General Message Play</b> Turn Off or On an extension user ability to dial 4 or Service Code 611 to listen to the General Message.	0 = Off 1 = On	COS 1 ~ 14 = 0 COS 15 = 1		✓	
20-07-15	<b>Class of Service Options (Administrator Level) – VRS General Message Record/Delete</b> Turn Off or On an extension user ability to dial Service Code 612 and record, listen to, or erase the General Message.	0 = Off 1 = On	COS 1 ~ 14 = 0 COS 15 = 1		✓	
20-07-18	<b>Class of Service Options (Administrator Level) – SMDR Printout Accumulated Extension Data</b> Determine if the Accumulated Extension Data is included in the SMDR printout for each Class of Service.	0 = Off 1 = On	COS 1 ~ 14 = 0 COS 15 = 1		✓	
20-07-19	<b>Class of Service Options (Administrator Level) – SMDR Printout Department Group (STG) Data</b> Determine if the Department Group (STG) Data is included in the SMDR printout for each Class of Service.	0 = Off 1 = On	COS 1 ~ 14 = 0 COS 15 = 1		✓	
20-07-20	<b>Class of Service Options (Administrator Level) – SMDR Printout Accumulated Account Code Data</b> Determine if the Accumulated Account Code Data is included in the SMDR printout for each Class of Service.	0 = Off 1 = On	COS 1 ~ 14 = 0 COS 15 = 1		✓	
20-07-21	<b>Class of Service Options (Administrator Level) – Register and Delete DECTPP</b> Allows the administrator to register and delete DECT telephones.	0 = Off 1 = On	COS 1 ~ 15 = 0		✓	

Program Number	Program Name/Description	Input Data	Default	Level		
				1	2	3
20-07-23	<b>Class of Service Options (Administrator Level) – CO Message Waiting Indication Callback Number Programming</b> Enable (1)/Disable (0) an extension ability to receive CO Message Waiting Indication.	0 = Off 1 = On	COS 1 ~ 15 = 0		✓	
20-07-24	<b>Class of Service Options (Administrator Level) – Set/Cancel Private Call Refuse</b> Enable (1) or Disable (0) an extension user ability to set or cancel Private Call Refuse.	0 = Off 1 = On	COS 1 ~ 15 = 0		✓	
20-07-25	<b>Class of Service Options (Administrator Level) – Set/Cancel Caller ID Refuse</b> Enable/Disable an extension ability to set or cancel Caller ID Refuse.	0 = Off 1 = On	COS 1 ~ 15 = 0		✓	
20-07-26	<b>Class of Service Options (Administrator Level) – Dial-In Mode Switch</b> Enable/Disable an extension user ability to set or cancel dial-in mode switch.	0 = Off 1 = On	COS 1 ~ 15 = 0		✓	
20-07-27	<b>Class of Service Options (Administrator Level) – Do-Not-Call Administrator</b> Enable/Disable an extension user ability to set or cancel do not call administrator.	0 = Off 1 = On	COS 1 ~ 15 = 0		✓	
20-07-30	<b>Class of Service Options (Administrator Level) – Date Setting</b> Enable/Disable an extension user ability to set the Date using the service code defined in Program 11-10-41.	0 = Off 1 = On	COS 1 ~ 15 = 1		✓	
20-08-01	<b>Class of Service Options (Outgoing Call Service) – Intercom Calls</b> Turn Off or On Intercom calling for the extension.	0 = Off 1 = On	COS 1 ~ 15 = 1		✓	
20-08-02	<b>Class of Service Options (Outgoing Call Service) – Trunk Outgoing Calls</b> Turn Off or On outgoing trunk calling for the extension.	0 = Off 1 = On	COS 1 ~ 15 = 1		✓	
20-08-03	<b>Class of Service Options (Outgoing Call Service) – System Speed Dialing</b> Turn Off or On an extension user ability to make outbound calls using system speed dial numbers.	0 = Off 1 = On	COS 1 ~ 15 = 1		✓	
20-08-04	<b>Class of Service Options (Outgoing Call Service) – Group Speed Dialing</b> Turn Off or On an extension user ability to make outbound calls using group speed dial numbers.	0 = Off 1 = On	COS 1 ~ 15 = 1		✓	
20-08-05	<b>Class of Service Options (Outgoing Call Service) – Dial Number Preview (Preset Dial)</b> Turn Off or On extension user ability to use Dial Number Preview.	0 = Off 1 = On	COS 1 ~ 15 = 1		✓	

Program Number	Program Name/Description	Input Data	Default	Level		
				1	2	3
20-08-06	<b>Class of Service Options (Outgoing Call Service) – Toll Restriction Override</b> Turn Off or On Toll Restricting Override (Service Code 663).	0 = Off 1 = On	COS 1 ~ 15 = 0		✓	
20-08-07	<b>Class of Service Options (Outgoing Call Service) – Repeat Redial</b> Turn Off or On an extension user ability to use Repeat Redial.	0 = Off 1 = On	COS 1 ~ 15 = 1		✓	
20-08-08	<b>Class of Service Options (Outgoing Call Service) – Toll Restriction Dial Block</b> Turn Off or On an extension user ability to use Dial Block.	0 = Off 1 = On	COS 1 ~ 15 = 0		✓	
20-08-09	<b>Class of Service Options (Outgoing Call Service) – Hotline/Extension Ringdown</b> Turn Off or On Ringdown Extension for extensions with this COS.	0 = Off 1 = On	COS 1 ~ 15 = 0		✓	
20-08-10	<b>Class of Service Options (Outgoing Call Service) – Signal/Voice Call</b> Turn Off or On an extension allowing it to force Handsfree Answerback or Forced Intercom Ringing for outgoing Intercom calls.	0 = Off 1 = On	COS 1 ~ 15 = 1		✓	
20-08-11	<b>Class of Service Options (Outgoing Call Service) – Protect for the Call Mode Switching from Caller</b> When an extension is set to ring mode for ICM calls, enabling this option prevents callers from changing the call to voice announce mode.	0 = Off 1 = On	COS 1 ~ 15 = 0		✓	
20-08-12	<b>Class of Service Options (Outgoing Call Service) – Department Group Step Calling</b> Turn Off or On an extension user ability to use Department Group Step Calling.	0 = Off 1 = On	COS 1 ~ 15 = 1		✓	
20-08-13	<b>Class of Service Options (Outgoing Call Service) – ISDN CLIP</b> Determine if the ISDN calling line identity presentation and screening indicators are to be allowed.	0 = Off 1 = On	COS 1 ~ 15 = 0		✓	
20-08-14	<b>Class of Service Options (Outgoing Call Service) – Call Address Information</b> Enable/ Disable Call Address Information for each Class of Service.	0 = Off 1 = On	COS 1 ~ 15 = 0		✓	



Program Number	Program Name/Description	Input Data	Default	Level		
				1	2	3
20-08-15	<p><b>Class of Service Options (Outgoing Call Service) – Block Outgoing Caller ID</b></p> <p>Turn Off or On a user Class of Service from automatically blocking outgoing Caller ID information when a call is placed. If block is enabled, the system automatically inserts the Caller ID block code *67 (defined in Program 14-01-21) before the user dialed digits (this requires Program 14-02-10 to be enabled). If block is disabled, the system outdials the call just as it was dialed by the user.</p>	<p>0 = Off 1 = On</p>	COS 1 ~ 15 = 0		✓	
20-08-16	<p><b>Class of Service Options (Outgoing Call Service) – Display E911 Dialed Extension Name and Number</b></p> <p>Turn Off or On an extension ability to display the name and number of the extension that dialed 911.</p>	<p>0 = Off 1 = On</p>	COS 1 ~ 15 = 0		✓	
20-08-17	<p><b>Class of Service Options (Outgoing Call Service) – ARS Override of Trunk Access Map</b></p> <p>Turn Off or On an extension user ability to override the trunk access map programming for outgoing calls.</p>	<p>0 = Off 1 = On</p>	COS 1 ~ 15 = 0		✓	
20-08-19	<p><b>Class of Service Options (Outgoing Call Service) – Hotline for SPK</b></p> <p>Turn Off or On an extension user ability to activate hotline or ringdown when pressing the Speaker key.</p>	<p>0 = Off 1 = On</p>	COS 1 ~ 15 = 0		✓	
20-08-20	<p><b>Class of Service Options (Outgoing Call Service) – Hot Key Pad</b></p> <p>Turn Off or On an extension user ability to make a call by just dialing the number without first going off-hook.</p>	<p>0 = Off 1 = On</p>	COS 1 ~ 15 = 0		✓	
20-08-21	<p><b>Class of Service Options (Outgoing Call Service) – Automatic Trunk Seizing by Pressing Speaker Key</b></p> <p>Enable/Disable the ability to access trunks when going off-hook by pressing the speaker key for each Class of Service.</p>	<p>0 = Off 1 = On</p>	COS 1 ~ 15 = 0		✓	
20-08-22	<p><b>Class of Service Options (Outgoing Call Service) – Voice Over to busy Virtual Extension</b></p> <p>Enable/Disable the ability to make voice over to a busy virtual extension for each Class of Service.</p>	<p>0 = Off 1 = On</p>	COS 1 ~ 15 = 0		✓	
20-08-23	<p><b>Class of Service Options (Outgoing Call Service) – Display Indication for Security Sensor Detection</b></p> <p>Enable(1) or Disable(0) an extension's ability to display indication for security sensor detection.</p>	<p>0 = Off 1 = On</p>	COS 1 ~ 15 = 0		✓	

Program Number	Program Name/Description	Input Data	Default	Level		
				1	2	3
20-08-24	<p><b>Class of Service Options (Outgoing Call Service) – Display Indication for Emergency Call by Remote Inspection</b></p> <p>Enable(1) or Disable(0) an extension’s ability to display indication for emergency call by remote inspection.</p>	<p>0 = Off 1 = On</p>	COS 1 ~ 15 = 0		✓	
20-09-01	<p><b>Class of Service Options (Incoming Call Service) – Second Call for DID/DISA/DIL/ E&amp;M Override</b></p> <p>Turn Off or On the extension ability to receive a second call from a DID, DISA, DIL, or tie line caller.</p> <p>➡ <i>With this option set to 1, the destination extension must be busy for a second DNIS caller to ring through. If the destination extension does not have a line or Call Appearance (CAP) Keys available for the second call and a previous call is ringing the extension but has not been answered, the second caller hears busy regardless of this program setting.</i></p>	<p>0 = Off 1 = On</p>	COS 1 ~ 15 = 1		✓	
20-09-02	<p><b>Class of Service Options (Incoming Call Service) – Caller ID Display</b></p> <p>Turn Off or On the Caller ID display at an extension.</p>	<p>0 = Off 1 = On</p>	COS 1 ~ 15 = 0		✓	
20-09-03	<p><b>Class of Service Options (Incoming Call Service) – Sub Address Identification</b></p> <p>Define whether or not an extension displays the Caller Sub-Address.</p>	<p>0 = Off 1 = On</p>	COS 1 ~ 15 = 0		✓	
20-09-04	<p><b>Class of Service Options (Incoming Call Service) – Notification for Incoming Call List Existence</b></p> <p>Determine whether or not the CHECK LIST message is displayed to indicate a missed call.</p>	<p>0 = Off 1 = On</p>	COS 1 ~ 15 = 0		✓	
20-09-05	<p><b>Class of Service Options (Incoming Call Service) – Signal/Voice Call</b></p> <p>Turn Off or On an extension user ability to enable Handsfree Answerback or Forced Intercom Ringing for their incoming Intercom calls.</p>	<p>0 = Off 1 = On</p>	COS 1 ~ 15 = 1		✓	
20-09-06	<p><b>Class of Service Options (Incoming Call Service) – Incoming Time Display</b></p> <p>If this option is set to 1, the Incoming Call Time is displayed on the multiline terminals LCD while the telephone is ringing.</p> <p>➡ <i>Caller ID should be enabled for this feature in Program 20-09-06 to function.</i></p>	<p>0 = Off 1 = On</p>	COS 1 ~ 15 = 0		✓	

Program Number	Program Name/Description	Input Data	Default	Level		
				1	2	3
20-09-07	<b>Class of Service Options (Incoming Call Service) – Call Queuing</b> Turn Off or On an extension user ability to have calls queued if a call rings the extension when it is busy. ➡ Program 20-13-06 must be set to 0 (Off) for this feature to work.	0 = Off 1 = On	COS 1 ~ 15 = 1		✓	
20-09-08	<b>Class of Service Options (Incoming Call Service) – Calling Party Information</b> Turn Off or On and extension user ability to display calling party information on CCIS calls.	0 = Off 1 = On	COS 1 ~ 15 = 1		✓	
20-09-13	<b>Class of Service Options (Incoming Call Service) – DND Active While Ringing</b> Assign when the DND will be enforced (set at same time a call is ringing or for next call).	0 = Immediate 1 = Next	COS 1 ~ 15 = 0		✓	
20-10-01	<b>Class of Service Options (Answer Service) – Group Call Pickup (Within Group)</b> Turn Off or On Group Call Pickup for calls ringing an extension Pickup Group as well as ring group calls (Service Code *#).	0 = Off 1 = On	COS 1 ~ 15 = 1		✓	
20-10-02	<b>Class of Service Options (Answer Service) – Group Call Pickup (Another Group)</b> Turn Off or On Group Call Pickup for calls ringing outside a group (Service Code 769).	0 = Off 1 = On	COS 1 ~ 15 = 1		✓	
20-10-03	<b>Class of Service Options (Answer Service) – Group Call Pickup for Specific Group</b> Turn Off or On Group Call Pickup for a specific group using service code 768.	0 = Off 1 = On	COS 1 ~ 15 = 1		✓	
20-10-04	<b>Class of Service Options (Answer Service) – Telephone Call Pickup</b> Enable or Disable the group call pickup.	0 = Off 1 = On	COS 1 ~ 15 = 1		✓	
20-10-05	<b>Class of Service Options (Answer Service) – Directed Call Pickup for Own Group</b> Turn Off or On Directed Call Pickup for calls ringing an extension Pickup Group (Service Code 756).	0 = Off 1 = On	COS 1 ~ 15 = 1		✓	
20-10-06	<b>Class of Service Options (Answer Service) – Meet-Me Conference and Paging</b> Turn Off or On an extension to use Meet-Me Conference and Paging.	0 = Off 1 = On	COS 1 ~ 15 = 1		✓	
20-10-07	<b>Class of Service Options (Answer Service) – Automatic Off-Hook Answer</b> Turn Off or On an extension to use Universal Auto Answer (no service code required).	0 = Off 1 = On	COS 1 ~ 15 = 0		✓	

Program Number	Program Name/Description	Input Data	Default	Level		
				1	2	3
20-10-08	<b>Class of Service Options (Answer Service) – Virtual Extension Off-Hook Answer</b> Turn Off or On an extension user ability to answer an incoming call on a Call Arrival (CAR)/Secondary Incoming Extension (SIE)/ Virtual Extension simply by lifting the handset.	0 = Off 1 = On	COS 1 ~ 15 = 1		✓	
20-10-09	<b>Class of Service Options (Answer Service) – Call Pickup Callback</b> Turn Off or On an extension user ability to use Call Pickup to Pick up Callback calls.	0 = Off 1 = On	COS 1 ~ 15 = 1		✓	
20-10-10	<b>Class of Service Options (Answer Service) – Answer Preset</b> Enable/Disable Answer Preset for each Class of Service.	0 = Off 1 = On	COS 1 ~ 15 = 0		✓	
20-11-01	<b>Class of Service Options (Hold/Transfer Service) – Call Forward All</b> Turn Off or On an extension user ability to set Call Forward Immediate.	0 = Off 1 = On	COS 1 ~ 15 = 1		✓	
20-11-02	<b>Class of Service Options (Hold/Transfer Service) – Call Forward When Busy</b> Turn Off or On an extension user ability to set Call Forwarding when Busy.	0 = Off 1 = On	COS 1 ~ 15 = 1		✓	
20-11-03	<b>Class of Service Options (Hold/Transfer Service) – Call Forwarding When Unanswered</b> Turn Off or On an extension user ability to set Call Forwarding when Unanswered.	0 = Off 1 = On	COS 1 ~ 15 = 1		✓	
20-11-04	<b>Class of Service Options (Hold/Transfer Service) – Call Forwarding (Both Ringing)</b> Turn Off or On an extension user ability to set Call Forward with Follow Me.	0 = Off 1 = On	COS 1 ~ 15 = 1		✓	
20-11-05	<b>Class of Service Options (Hold/Transfer Service) – Call Forwarding with Follow Me</b> Turn Off or On an extension user ability to set Call Forward with Follow Me.	0 = Off 1 = On	COS 1 ~ 15 = 1		✓	
20-11-06	<b>Class of Service Options (Hold/Transfer Service) – Unscreened Transfer (Ring Inward Transfer)</b> Turn Off or On an extension user ability to use Unscreened Transfer.	0 = Off 1 = On	COS 1 ~ 15 = 1		✓	
20-11-07	<b>Class of Service Options (Hold/Transfer Service) – Transfer Without Holding</b> Turn Off or On an extension user ability to use Transfer Without Holding.	0 = Off 1 = On	COS 1 ~ 15 = 0		✓	
20-11-08	<b>Class of Service Options (Hold/Transfer Service) – Transfer Information Display</b> Turn Off or On an extension incoming Transfer pre-answer display.	0 = Off 1 = On	COS 1 ~ 15 = 1		✓	

Program Number	Program Name/Description	Input Data	Default	Level		
				1	2	3
20-11-09	<b>Class of Service Options (Hold/Transfer Service) – Group Hold Initiate</b> Turn Off or On an extension ability to initiate a Group Hold.	0 = Off 1 = On	COS 1 ~ 15 = 1		✓	
20-11-10	<b>Class of Service Options (Hold/Transfer Service) – Group Hold Answer</b> Turn Off or On an extension ability to pick up a call on Group Hold.	0 = Off 1 = On	COS 1 ~ 15 = 1		✓	
20-11-11	<b>Class of Service Options (Hold/Transfer Service) – Automatic On-Hook Transfer</b> Turn Off or On an extension ability to use Automatic On-Hook Transfer.	0 = Off 1 = On	COS 1 ~ 15 = 0		✓	
20-11-12	<b>Class of Service Options (Hold/Transfer Service) – Call Forwarding Off-Premise (External Call Forwarding)</b> Turn Off or On an extension user ability to set up Call Forwarding Off-Premise at the extension.	0 = Off 1 = On	COS 1 ~ 15 = 0		✓	
20-11-13	<b>Class of Service Options (Hold/Transfer Service) – Operator Transfer After Hold Callback</b> Turn Off or On an extension ability to have a call which recalls from hold transfer to the operator.	0 = Off 1 = On	COS 1 ~ 15 = 0		✓	
20-11-14	<b>Class of Service Options (Hold/Transfer Service) – Trunk-to-Trunk Transfer Restriction</b> Turns Off or On the Trunk-to-Trunk Transfer Restriction. If enabled, Trunk-to-Trunk Transfer is not possible.	0 = Off 1 = On	COS 1 ~ 15 = 0		✓	
20-11-15	<b>Class of Service Options (Hold/Transfer Service) – VRS Personal Greeting (Message Greeting)</b> Turn Off or On an extension user ability to dial Service Code 616 to record, listen to or erase the Personal Greeting Message.	0 = Off 1 = On	COS 1 ~ 15 = 1		✓	
20-11-16	<b>Class of Service Options (Hold/Transfer Service) – Call Redirect</b> Turn Off or On an extension user ability to transfer a call to a predefined destination (such as an operator, voice mail, or another extension) without answering the call.	0 = Off 1 = On	COS 1 ~ 15 = 1		✓	
20-11-17	<b>Class of Service Options (Hold/Transfer Service) – Department Group Trunk-to-Trunk Transfer (Each Telephone Group Transfer)</b> Turn Off or On the ability of an extension in a Department Group to use the Trunk-to-Trunk Forwarding service codes.	0 = Off 1 = On	COS 1 ~ 15 = 1		✓	

Program Number	Program Name/Description	Input Data	Default	Level		
				1	2	3
20-11-18	<b>Class of Service Options (Hold/Transfer Service) – No Recall</b> Allow (0)/Deny (1) answered Transferred calls from recalling the originating extension.	0 = Off 1 = On	COS 1 ~ 15 = 0		✓	
20-11-19	<b>Class of Service Options (Hold/Transfer Service) – Hold/Extended Park</b> Determine whether an extension Class of Service should allow normal or extended Park (0 = Normal for Program 24-01-06, 1 = Extended for Program 24-01-07).	0 = Off 1 = On	COS 1 ~ 15 = 0		✓	
20-11-20	<b>Class of Service Options (Hold/Transfer Service) – No Callback</b> Turn Off or On an extension ability to receive Callbacks.	0 = Off 1 = On	COS 1 ~ 15 = 0		✓	
20-11-21	<b>Class of Service Options (Hold/Transfer Service) – Restriction for Tandem Trunking on Hang Up</b> Allow/Deny an extension user ability to set up a tandem/conference call automatically when they hang up.	0 = Off 1 = On	COS 1 ~ 15 = 0		✓	
20-11-22	<b>Class of Service Options (Hold/Transfer Service) – Restricted Unsupervised Conference</b> Allow/Deny an extension user to initiate a Trunk-to-Trunk Transfer (Tandem Trunking).	0 = Off 1 = On	COS 1 ~ 15 = 0		✓	
20-11-23	<b>Class of Service Options (Hold/Transfer Service) – CAR/VE Call Forward Set/Cancel</b> Turn Off or On an extension user ability to set and cancel Call Forwarding for a CAR or Virtual Extension.	0 = Off 1 = On	COS 1 ~ 15 = 1		✓	
20-11-24	<b>Class of Service Options (Hold/Transfer Service) – Trunk Park Hold Mode</b> Set the hold type when a trunk call is put on hold by an extension.	0 = Non Exclusive Hold (Off) 1 = Exclusive Hold (On)	COS 1 ~ 15 = 1		✓	
20-11-25	<b>Class of Service Options (Hold/Transfer Service) – Transfer Park Call</b> Turn On or Off an extension user ability to transfer a parked call.	0 = Off 1 = On	COS 1 ~ 15 = 1		✓	
20-11-26	<b>Class of Service Options (Hold/Transfer Service) – Station Park Hold Mode</b> Turn Off or On an extension users ability to Personal Park on a Co-Worker's extension.	0 = Off 1 = On	COS 1 ~ 15 = 0		✓	
20-11-27	<b>Class of Service Options (Hold/Transfer Service) – Call Park Automatically Search</b> Turn Off or On using the Call Park Automatically Search option.	0 = Off 1 = On	COS 1 ~ 15 = 1		✓	

Program Number	Program Name/Description	Input Data	Default	Level		
				1	2	3
20-11-28	<b>Class of Service Options (Hold/Transfer Service) – Both Ring Enhancement</b> 0 = Normal (default) rings on other extension when the other paired extension is busy (not idle). 1 = Enhanced does not ring other extension when the other paired extension is busy (not idle).	0 = Normal 1 = Enhanced	COS 1 ~ 15 = 0		✓	
20-11-30	<b>Class of Service Options (Hold/Transfer Service) – Disable Call FWD Indication on LCD</b> When set to On (1), Call FWD setting is not shown on the terminal LCD.	0 = Off 1 = On	COS 1 ~ 15 = 1		✓	
20-12-02	<b>Class of Service Options (Charging Cost Service) – Advice of Charge</b> ISDN-AOC Turn Off or On a DISA or tie trunk caller ability to dial 9 for Trunk Group Routing or Automatic Route Selection (ARS).	0 = Off 1 = On	COS 1 ~ 15 = 0		✓	
20-12-03	<b>Class of Service Options (Charging Cost Service) – Cost Display (TTU)</b> ISDN billing information.	0 = Off 1 = On	COS 1 ~ 15 = 1		✓	
20-13-01	<b>Class of Service Options (Supplementary Service) – Long Conversation Alarm</b> Turn Off or On the Warning Tone for Long Conversation (not for single line telephones).	0 = Off 1 = On	COS 1 ~ 15 = 0		✓	
20-13-02	<b>Class of Service Options (Supplementary Service) – Long Conversation Cutoff (Incoming)</b> Turn Off or On an extension user ability to use Long Conversation Cutoff for incoming calls.	0 = Off 1 = On	COS 1 ~ 15 = 0		✓	
20-13-03	<b>Class of Service Options (Supplementary Service) – Long Conversation Cutoff (Outgoing)</b> Turn Off or On an extension user ability to use Long Conversation Cutoff for outgoing calls.	0 = Off 1 = On	COS 1 ~ 15 = 0		✓	
20-13-04	<b>Class of Service Options (Supplementary Service) – Call Forward/DND Override (Bypass Call)</b> Turn Off or On the ability to use Call Forwarding/DND Override.	0 = Off 1 = On	COS 1 ~ 15 = 1		✓	
20-13-05	<b>Class of Service Options (Supplementary Service) – Intercom Off-Hook Signaling</b> Turn On or Off the ability of an extension to send Off-Hook Signals. ➡ This setting functions with Programs 20-09-07 and 20-13-06 disabled.	0 = Off 1 = On	COS 1 ~ 15 = 1		✓	

Program Number	Program Name/Description	Input Data	Default	Level		
				1	2	3
20-13-06	<b>Class of Service Options (Supplementary Service) – Automatic Off-Hook Signaling (Automatic Override)</b> Allow a busy extension user to Manually (0) or Automatically (1) receive off-hook signals. ➤ This setting is to receive incoming call signaling information during call queuing.	0 = Off 1 = On	COS 1 ~ 15 = 1		✓	
20-13-07	<b>Class of Service Options (Supplementary Service) – Message Waiting</b> Turn Off or On an extension user ability to leave Message Waiting.	0 = Off 1 = On	COS 1 ~ 15 = 1		✓	
20-13-08	<b>Class of Service Options (Supplementary Service) – Conference</b> Turn Off or On an extension user ability to initiate a conference or Meet Me Conference.	0 = Off 1 = On	COS 1 ~ 15 = 1		✓	
20-13-09	<b>Class of Service Options (Supplementary Service) – Privacy Release</b> Turn Off or On an extension user ability to initiate a Voice Call Conference.	0 = Off 1 = On	COS 1 ~ 15 = 1		✓	
20-13-10	<b>Class of Service Options (Supplementary Service) – Barge-In Monitor</b> Enables the extension Barge-In Mode to be Speech mode or Monitor mode (i.e., Barge-In initiator).	0 = Off 1 = On	COS 1 ~ 15 = 0		✓	
20-13-11	<b>Class of Service Options (Supplementary Service) – Room Monitor, Initiating Extension</b> Turn Off or On an extension user ability to Room Monitor other extensions.	0 = Off 1 = On	COS 1 ~ 15 = 0		✓	
20-13-12	<b>Class of Service Options (Supplementary Service) – Room Monitor, Extension Being Monitored</b> Turn Off or On an extension user ability to be monitored by other extensions.	0 = Off 1 = On	COS 1 ~ 15 = 0		✓	
20-13-13	<b>Class of Service Options (Supplementary Service) – Continued Dialing (DTMF) Signal on ICM Call</b> Turn Off or On the extension ability to use Continued Dialing, which allows DTMF signal sending while talking on extension.	0 = Off 1 = On	COS 1 ~ 15 = 1		✓	
20-13-14	<b>Class of Service Options (Supplementary Service) – Department Calling (PLT No Called Extension)</b> Turn Off or On an extension user ability to call a Department Group Pilot.	0 = Off 1 = On	COS 1 ~ 15 = 1		✓	



Program Number	Program Name/Description	Input Data	Default	Level		
				1	2	3
20-13-15	<b>Class of Service Options (Supplementary Service) – Barge-In, Initiate</b> Turn Off or On an extension user ability to barge-in on other's calls.	0 = Off 1 = On	COS 1 ~ 15 = 0		✓	
20-13-16	<b>Class of Service Options (Supplementary Service) – Barge-In, Receive</b> Turn Off or On Barge-In at the receiving extension (i.e., Barge-In receive).	0 = Off 1 = On	COS 1 ~ 15 = 0		✓	
20-13-17	<b>Class of Service Options (Supplementary Service) – Barge-In Tone/Display (Intrusion Tone)</b> Turn Off or On the Barge-In (Intrusion) Tone. If disabled, this also turns off the Barge-In display at the called extension.	0 = Off 1 = On	COS 1 ~ 15 = 1		✓	
20-13-18	<b>Class of Service Options (Supplementary Service) – Programmable Function Key Programming (General Level)</b> Turn Off or On an extension user ability to program General function keys using Service Code 751 (by default). (Refer to Program 20-07-10 for Service Code 752.)	0 = Off 1 = On	COS 1 ~ 15 = 1		✓	
20-13-19	<b>Class of Service Options (Supplementary Service) – Selectable Display Messaging (Text Messaging)</b> Turn Off or On an extension user ability to use Selectable Display Messaging.	0 = Off 1 = On	COS 1 ~ 15 = 1		✓	
20-13-20	<b>Class of Service Options (Supplementary Service) – Account Code/Toll Restriction Operator Alert (Restricted Operation Transfer)</b> Turn Off or On operator alert when an extension improperly enters an Account Code or violates Toll Restriction.	0 = Off 1 = On	COS 1 ~ 15 = 0		✓	
20-13-21	<b>Class of Service Options (Supplementary Service) – Extension Name</b> Turn Off or On an extension user ability to program the name.	0 = Off 1 = On	COS 1 ~ 15 = 1		✓	
20-13-22	<b>Class of Service Options (Supplementary Service) – Busy Status Display (Called Party Status)</b> Turn Off or On the ability to display the detail state of called party.	0 = Off 1 = On	COS 1 ~ 15 = 0		✓	
20-13-23	<b>Class of Service Options (Supplementary Service) – Display the Reason for Transfer</b> Select whether an extension should display the reason a call is being transferred to their extension (Call Forward Busy, Call Forward No Answer, DND).	0 = Off 1 = On	COS 1 ~ 15 = 0		✓	

Program Number	Program Name/Description	Input Data	Default	Level		
				1	2	3
20-13-24	<b>Class of Service Options (Supplementary Service) – Privacy Release by Pressing Line Key</b> Turn Off or On a user ability to press a line key to barge into an outside call. The Barge-In feature must be enabled if this option is used.	0 = Off 1 = On	COS 1 ~ 15 = 0		✓	
20-13-26	<b>Class of Service Options (Supplementary Service) – Group Listen</b> Turn Off or On an extension user ability to use Group Listen.	0 = Off 1 = On	COS 1 ~ 15 = 1		✓	
20-13-27	<b>Class of Service Options (Supplementary Service) – Busy on Seizing Virtual Extension</b> If set to 1, you can call a busy extension which is talking on a virtual extension key. Program 20-13-06 (Call Waiting) must be set to off for this option to work.	0 = Off 1 = On	COS 1 ~ 15 = 1		✓	
20-13-28	<b>Class of Service Options (Supplementary Service) – Allow Class of Service to be Changed</b> Turn Off or On the ability of an extension COS to be changed via Service Code 677.	0 = Off 1 = On	COS 1 ~ 15 = 0		✓	
20-13-29	<b>Class of Service Options (Supplementary Service) – Paging Display</b> Turn Off or On an extension user ability to display paging information.	0 = Off 1 = On	COS 1 ~ 15 = 1		✓	
20-13-30	<b>Class of Service Options (Supplementary Service) – Background Music</b> Allow/Deny an extension user to turn Background Music on and off.	0 = Off 1 = On	COS 1 ~ 15 = 1		✓	
20-13-31	<b>Class of Service Options (Supplementary Service) – Connected Line Identification (COLP)</b> Define the supplementary feature availability for each extension Class of Service (COS).	0 = Off 1 = On	COS 1 ~ 15 = 0		✓	
20-13-32	<b>Class of Service Options (Supplementary Service) – Deny Multiple Barge-Ins</b> Turn Off or On an extension user ability to have multiple users Barge-In to their conversation.	0 = Off 1 = On	COS 1 ~ 15 = 0		✓	
20-13-33	<b>Class of Service Options (Supplementary Service) – Contact Center Supervisor’s Position Enhancement</b> This option must be on for the operator to use service codes in Program 11-13-10 through Program 11-13-13.	0 = Off 1 = On	COS 1 ~ 15 = 0		✓	
20-13-34	<b>Class of Service Options (Supplementary Service) – Block Manual Off-Hook Signaling</b> Turn Off or On an extension user ability to block off-hook signals manually sent from a co-worker.	0 = Off 1 = On	COS 1 ~ 15 = 0		✓	

Program Number	Program Name/Description	Input Data	Default	Level		
				1	2	3
20-13-35	<b>Class of Service Options (Supplementary Service) – Block Camp-On</b> Turn Off or On an extension user ability to block callers from dialing to camp-on.	0 = Off 1 = On	COS 1 ~ 15 = 0		✓	
20-13-36	<b>Class of Service Options (Supplementary Service) – Call Duration Timer Display</b> Turn Off or On a Call Timer for the extension.	0 = Off 1 = On	COS 1 ~ 15 = 1		✓	
20-13-38	<b>Class of Service Options (Supplementary Service) – Headset Ringing for SLT</b> Turn Off or On an extension user ability to use the Headset ringing.	0 = Off 1 = On	COS 1 ~ 15 = 0		✓	
20-13-39	<b>Class of Service Options (Supplementary Service) – Contact Center Queue Status Display</b> Turn Off or On the Contact Center Queue Status Display for an extension Class of Service. Any extension which has this option enabled also hears the queue alarm.	0 = Off 1 = On	COS 1 ~ 15 = 0		✓	
20-13-40	<b>Class of Service Options (Supplementary Service) – Do Not Disturb</b> Turn Off or On an extension user ability to set or cancel Do Not Disturb.	0 = Off 1 = On	COS 1 ~ 15 = 1		✓	
20-13-41	<b>Class of Service Options (Supplementary Service) – Voice Mail Message Indication on DSS</b> Turn Off or On the Voice Mail Message Indication for an extension on a DSS console.	0 = Off 1 = On	COS 1 ~ 15 = 0		✓	
20-13-42	<b>Class of Service Options (Supplementary Service) – Extension Data Swap Enabling</b> Turn Off or On an extension user ability to use the Station Relocation feature.	0 = Off 1 = On	COS 1 ~ 15 = 1		✓	
20-13-43	<b>Class of Service Options (Supplementary Service) – Disconnect Supervision</b>	0 = Off 1 = On	COS 1 ~ 15 = 1		✓	
20-13-44	<b>Class of Service Options (Supplementary Service) – Live Monitor Enabling</b> Turn Off or On an extension ability to use Live Monitor.	0 = Off 1 = On	COS 1 ~ 15 = 1		✓	
20-13-45	<b>Class of Service Options (Supplementary Service) – MIC Key Mode While Call Monitoring</b> Set per class of service, when in Call Monitoring Mode determines if the monitored parties receives the barge in alert tone when Coaching Mode is enabled.	0 = Off 1 = On	COS 1 ~ 15 = 1		✓	

Program Number	Program Name/Description	Input Data	Default	Level		
				1	2	3
20-13-47	<b>Class of Service Options (Supplementary Service) – Station Number Display</b> Determine if a station Number is displayed (On) or not displayed (Off) in the LCD when the phone is idle.	0 = Off 1 = On	COS 1 ~ 15 = 1		✓	
20-13-48	<b>Class of Service Options (Supplementary Service) – Station Name Display</b> Determine if a station Number is displayed (On) or not displayed (Off) in the LCD when the phone is idle.	0 = Off 1 = On	COS 1 ~ 15 = 1		✓	
20-13-49	<b>Class of Service Options (Supplementary Service) – BLF Indication on CO Incoming State</b> Determine if a BLF of the station lights when a Normal CO call is ringing the phone.	0 = Off 1 = On	COS 1 ~ 15 = 0		✓	
20-13-50	<b>Class of Service Options (Supplementary Service) – AIC Agent display which call is from</b> Determine if the station logged in via AIC codes shows which queue the call is coming from.	0 = Off 1 = On	COS 1 ~ 15 = 1		✓	
20-13-51	<b>Class of Service Options (Supplementary Service) – Number and Name appear in the directory</b> Determine if an extension name and number are listed (On) or unlisted (Off) in the directory.	0 = Off 1 = On	COS 1 ~ 15 = 1		✓	
20-13-52	<b>Class of Service Options (Supplementary Service) – VoIP All DSP Busy Display</b> Enable/Disable the All DSP Busy alarm displayed on the LCD when the caller makes an IP call and there is no VoIP DSP resource.	0 = Off 1 = On	COS 1 ~ 15 = 1		✓	
20-13-53	<b>Class of Service Options (Supplementary Service) – Language Selection for Specific Extension</b> This setting must be Enabled (1) for a telephones Class of Service for this feature to function.	0 = Off 1 = On	COS 1 ~ 15 = 0		✓	
20-13-54	<b>Class of Service Options (Supplementary Service) – Call Waiting for Standard SIP Terminal</b> Set up Call waiting (Off-hook Signaling) for Standard SIP terminal.	0 = Off 1 = On	COS 1 ~ 15 = 0		✓	
20-14-01	<b>Class of Service Options for DISA/E&amp;M – First Digit Absorption (Delete First Digit Dialed)</b> For Tie Lines, Enable/Disable the ability to absorb (ignore) the first incoming digit. Use this to make the tie trunk compatible with 3- and 4-digit Tie Line service. This option does not apply to DISA.	0 = Off 1 = On	COS 1 ~ 15 = 0		✓	

Program Number	Program Name/Description	Input Data	Default	Level		
				1	2	3
20-14-02	<b>Class of Service Options for DISA/E&amp;M – Trunk Group Routing/ARS Access</b> Enable/Disable a DISA or tie trunk caller ability to dial 9 for Trunk Group Routing or Automatic Route Selection (ARS).	0 = Off 1 = On	COS 1 ~ 15 = 1		✓	
20-14-03	<b>Class of Service Options for DISA/E&amp;M – Trunk Group Access</b> Enable/Disable a DISA or tie trunk caller ability to access trunk groups for outside calls (Service Code 704).	0 = Off 1 = On	COS 1 ~ 15 = 1		✓	
20-14-04	<b>Class of Service Options for DISA/E&amp;M – Outgoing System Speed Dial</b> Enable/Disable a DISA or tie trunk caller's ability to use System Speed Dialing.	0 = Off 1 = On	COS 1 ~ 15 = 0		✓	
20-14-05	<b>Class of Service Options for DISA/E&amp;M – Operator Calling</b> Enable/Disable a DISA or tie trunk caller ability to dial 0 for the telephone system operator.	0 = Off 1 = On	COS 1 ~ 15 = 1		✓	
20-14-06	<b>Class of Service Options for DISA/E&amp;M – Internal Paging</b> Enable/Disable a DISA or tie trunk caller's ability to use the telephone system Internal Paging.	0 = Off 1 = On	COS 1 ~ 15 = 1		✓	
20-14-07	<b>Class of Service Options for DISA/E&amp;M – External Paging</b> Enable/Disable a DISA or tie trunk caller ability to use the telephone system External Paging.	0 = Off 1 = On	COS 1 ~ 15 = 1		✓	
20-14-08	<b>Class of Service Options for DISA/E&amp;M – Direct Trunk Access</b> Enable/Disable a DISA or tie trunk caller ability to use Direct Trunk Access (Service Code 715).	0 = Off 1 = On	COS 1 ~ 15 = 0		✓	
20-14-09	<b>Class of Service Options for DISA/E&amp;M – Forced Trunk Disconnect &lt;Not for ISDN T-point&gt;</b> Enable/Disable a tie trunk caller ability to use Forced Trunk Disconnect (Service Code *26). This option is not available to DISA callers.	0 = Off 1 = On	COS 1 ~ 15 = 0		✓	
20-14-10	<b>Class of Service Options for DISA/E&amp;M – Call Forward Setting by Remote via DISA</b> Enable/Disable a DISA callers ability to use the Call Forward service codes (Program 11-11-01 through Program 11-11-05).	0 = Off 1 = On	COS 1 ~ 15 = 0		✓	
20-14-11	<b>Class of Service Options for DISA/E&amp;M – DISA/Tie Trunk Barge-In</b> Enable/Disable a DISA or tie trunk user from using the Barge-In feature.	0 = Off 1 = On	COS 1 ~ 15 = 0		✓	

Program Number	Program Name/Description	Input Data	Default	Level		
				1	2	3
20-14-12	<b>Class of Service Options for DISA/E&amp;M – Retrieve Park Hold</b> Turn Off or On the ability for a DISA caller to retrieve parked or held calls. ➤ Only applies to CCIS trunks.	0 = Off 1 = On	COS 1 ~ 15 = 1		✓	

## Operation

### To change an extension Class of Service (via Service Code 677):

1. Press **Speaker**.
2. Dial **677**.
3. Dial the extension number you want to change.
  - ◇ You see: *MODE1:nn*  
Press **Hold** to leave the current value unchanged.  
The extension you dial may be set to block your attempt to change their Class of Service.
4. Enter the Day 1 Mode Class of Service for the extension you selected in step 3 and press **Hold**.
  - ◇ You see: *MODE2:nn*  
Press **Hold** to leave the current value unchanged.
5. Enter the Night 1 Mode Class of Service for the extension you selected in step 3 and press **Hold**.
  - ◇ You see: *MODE3:nn*  
Press **Hold** to leave the current value unchanged.
6. Enter the Midnight 1 Mode Class of Service for the extension you selected in step 3 and press **Hold**.
  - ◇ You see: *MODE4:nn*  
Press **Hold** to leave the current value unchanged.
7. Enter the Rest 1 Mode Class of Service for the extension you selected in step 3 and press **Hold**.
  - ◇ You see: *MODE5:nn*  
Press **Hold** to leave the current value unchanged.
8. Enter the Day 2 Mode Class of Service for the extension you selected in step 3 and press **Hold**.
  - ◇ You see: *MODE6:nn*  
Press **Hold** to leave the current value unchanged.
9. Enter the Night 2 Mode Class of Service for the extension you selected in step 3 and press **Hold**.
  - ◇ You see: *MODE7:nn*  
Press **Hold** to leave the current value unchanged.
10. Enter the Midnight 2 Mode Class of Service for the extension you selected in step 3 and press **Hold**.
  - ◇ You see: *MODE8:nn*  
Press **Hold** to leave the current value unchanged.

11. Enter the Rest 2 Mode Class of Service for the extension you selected in step 3 and press **Hold**.

◇ *You see: ICM Dial*

12. Go to step 3 and enter another extension number.

**- OR -**

Press **Speaker** to hang up.

## Clock/Calendar Display

### Description

The system uses Clock/Calendar Display for:

- |   |   |
|---|---|
| <input type="checkbox"/> Central Office Calls (Access Maps) | <input type="checkbox"/> Station Message Detail Recording |
| <input type="checkbox"/> Class of Service (Class)           | <input type="checkbox"/> System Reports                   |
| <input type="checkbox"/> Direct Inward Lines                | <input type="checkbox"/> Toll Restriction (Class)         |
| <input type="checkbox"/> Display Telephones                 | <input type="checkbox"/> Trunk Group Routing              |
| <input type="checkbox"/> Night Service (Automatic)          | <input type="checkbox"/> Voice Mail                       |
| <input type="checkbox"/> Programmable Trunk Parameters      | <input type="checkbox"/> Voice Response System            |
| <input type="checkbox"/> Ring Groups                        | <input type="checkbox"/>                                  |

Using the Daylight Savings Setup program, you can determine whether the system should automatically adjust the system time for daylight savings time/standard time changes.

### Clock Adjustment

The system can be programmed to automatically adjust the system clock on a nightly basis. This feature allows you to make adjustments should the system cabinet regularly lose or gain time.

### Conditions

- The system retains the Clock/Calendar Display after a power failure or system reset.
- Changing the time may change the current Class of Service (COS) service depending on the COS mode setup.
- You can program the system to automatically switch modes.
- Single line telephones cannot set the time and date.
- Changing the system time automatically changes the InMail time.

### Default Settings

Enabled



## System Availability

### Terminals

All Multiline Terminals with Display

### Required Component(s)

None

## Related Features

- ↳ **Class of Service**
- ↳ **Night Service**
- ↳ **Single Line Telephones, Analog 500/2500 Sets**
- ↳ **InMail**
- ↳ **Voice Mail Integration (Analog)**

## Guide to Feature Programming

The **Level 1**, **Level 2** and **Level 3** columns indicate the programs that are assigned when programming this feature in the order they are most commonly used. These levels are used with PCPro and WebPro wizards for feature programming.

- Level 1 – these are the most commonly assigned programs for this feature.
- Level 2 – these are the next most commonly assigned programs for this feature.
- Level 3 – these programs are not often assigned and require an expert level working knowledge of the system to be properly assigned.

Program Number	Program Name/Description	Input Data	Default	Level		
				1	2	3
10-01-01	<b>Time and Date – Year</b> Enter two digits (13~ 97) for the year.	13 ~ 97	No Setting	✓		
10-01-02	<b>Time and Date – Month</b> Enter two digits (01 ~ 12) for the month.	01 ~ 12	No Setting	✓		
10-01-03	<b>Time and Date – Day</b> Enter two digits (01 ~ 31) for the day.	01 ~ 31	No Setting	✓		
10-01-04	<b>Time and Date – Week</b> Enter the digit (1 = Sunday, 7 = Saturday) to indicate the day of the week.	1 ~ 7 (Sunday ~ Saturday)	No Setting	✓		

Program Number	Program Name/Description	Input Data	Default	Level		
				1	2	3
10-01-05	<b>Time and Date – Hour</b> Enter two digits (00 ~ 23) for the hour.	00 ~ 23	No Setting	✓		
10-01-06	<b>Time and Date – Minute</b> Enter two digits (00 ~ 59) for the minutes.	00 ~ 59	No Setting	✓		
10-01-07	<b>Time and Date – Second</b> Enter two digits (00 ~ 59) for the seconds.	00 ~ 59	No Setting	✓		
10-24-01	<b>Daylight Savings Setup – Daylight Savings Mode</b> Enable/Disable the system ability to adjust the time for daylight savings/standard time.	0 = Disable 1 = Enable	1		✓	
10-24-02	<b>Daylight Savings Setup – Time for Daylight Savings</b> Enter the time of day the system should adjust for daylight savings time (0000 ~ 2359).	00:00 ~ 23:59	02:00		✓	
10-24-03	<b>Daylight Savings Setup – Start of Month (Summer Time)</b> Enter the month of system should adjust the time for daylight savings time (01 ~ 12).	01 ~ 12 1 = Jan 2 = Feb, etc.	3		✓	
10-24-04	<b>Daylight Savings Setup – Start of Week</b> Enter the week of the month the system should adjust the time for daylight savings time.	0 ~ 5 0 = Last Week of Month	2		✓	
10-24-05	<b>Daylight Savings Setup – Start of Week Day</b> Enter the day of the week the system should adjust the time for daylight savings time.	1 ~ 7 (1 = Sun, 2 = Mon, etc.)	1		✓	
10-24-06	<b>Daylight Savings Setup – End of Month</b> Enter the month of system should adjust the time for standard time.	01 ~ 12 (1 = Jan, 2 = Feb, etc.)	11		✓	
10-24-07	<b>Daylight Savings Setup – End of Week</b> Enter the week of the month the system should adjust the time for standard time.	0 ~ 5 0 = Last Week of the Month	1		✓	
10-24-08	<b>Daylight Savings Setup – End of Week Day</b> Enter the day of the week the system should adjust the time for daylight savings time.	1 ~ 7 (1 = Sun, 2 = Mon, etc.)	1		✓	
11-10-03	<b>Service Code Setup (for System Administrator) – Setting the System Time</b> Customize the system time Service Codes for the System Administrator.	MLT 0 ~ 9, *, # Maximum of eight digits	728		✓	

Program Number	Program Name/Description	Input Data	Default	Level		
				1	2	3
20-02-07	<b>System Options for Multiline Telephones – Time and Date Display Mode</b> Select the display mode (type 1 ~ 8) for Time and Date (i.e., time and date format).	1 ~ 8 Type 1 = (12 hour) 10 MAR TUE 3:15PM Type 2 = (12 hour) 3:15PM MAR 10 TUE Type 3 = (12 hour) 3-10 TUE 3:15 PM Type 4 = (12 hour) 3:15PM TUE 10 MAR Type 5 = (24 hour) 10 MAR TUE 15:15 Type 6 = (24 hour) 15:15 MAR 10 TUE Type 7 = (24 hour) 3-10 TUE 15:15 Type 8 = (24 hour) 15:15 TUE 10 MAR	3		✓	
20-06-01	<b>Class of Service for Extensions</b> Assign a Class of Service (1 ~ 15) to extensions.	Day Night/Mode: 1 ~ 8 Class of Service of Extensions (1 ~ 15)	Extension port 101 = Class 15 All other extension port = Class 1		✓	
20-07-03	<b>Class of Service Options (Administrator Level) – Time Setting</b> Turn Off or On an extension user ability to set the Time via Service Code 728.	0 = Off 1 = On	COS 1 ~ 15 = 1		✓	

## Operation

The date must be set in system programming (10-01).

### To set the system Time:

1. Press **Speaker**.
2. Dial **728**.
3. Dial two digits for the hour (24 hour clock, 13 = 1:00 PM).
4. Dial two digits for the minutes (00~59).
5. Press **Speaker** to hang up.

## Code Restriction

### Description

Code Restriction limits the numbers an extension user may dial. By allowing extensions to place only certain types of calls, you can better control long distance costs. The system applies Code Restriction according to the Code Restriction Class. The system allows for up to 15 Code Restriction Classes and 960 extensions.

### Conditions

- If a Code Restriction Class has the same entries in both a permit and restriction table, the system does not restrict the call.
- Code Call Digit counting may prevent users from taking advantage of long distance automated services like Contact Center and automated Technical Service.
- Code Restriction is applied when accessing ARS.
- If Program 21-01-10 is programmed with an entry other than 0, a call cannot have a talk path unless the user dials at least the number of digits entered in this option when placing an out going call. This means that an entry of 4 or higher in this program causes a problem when dialing 911. Since it is only a 3-digit number, the call does not have a talk path, preventing the emergency dispatcher from hearing the caller. This option should be kept at its default setting of 0 to prevent any problem with dialing 911.
- Common Permit Code Table  
Use the Common Permit Code Table when you have numbers you want all Code Restriction Classes to dial. To let all users dial 911, for example, put 911 in the Common Permit Code Table. The Common Permit Code Table overrides the Restrict Code and Common Restrict Code Tables. The system provides 10 tables, with up to four digits in each table entry. Each code is four digits maximum, using 0~9, #, \* and Recall (as a wild card).
- Common Restrict Code Table  
The Common Restrict Code Table lets you globally restrict certain numbers for all Code Restriction Classes. To prevent all users from dialing directory assistance (411), for example, put 411 in the Common Restrict Code Table. Be sure you do not allow the codes you want to restrict in the Permit Code Table or the Common Permit Code Table. The system provides 10 tables, with up to four digits in each table entry. Each code is 12 digits maximum, using 0~9, #, \* and Recall (as a wild card).

- Restrict Code Table

When you want Code Restriction to allow most calls and restrict only selected calls, use the Restrict Code Table. To block only 1-900 calls, for example, enter 1900 in the Restrict Code Table. (If the same Code Restriction Class has both Permit and Restrict Code Tables, the system restricts calls that you enter only in the Restrict Code Table. Calls entered in both tables are not restricted.) The system provides four tables, with 60 entries (restricted codes) in each table. A restricted code is 12 digits maximum, using 0~9, #, \* and Recall (as a wild card).

- Permit Code Table

The Permit Code Table lets you set up Code Restriction so that users can dial only selected (permitted) telephone numbers. Use this table when you want to restrict most calls. To allow all users to dial only area code 203, for example, enter 1203 in the Permit Code Table. 1 + 203 + NNX + nnnn are the only numbers users can dial. (If the same Code Restriction Class has both Permit and Restrict Code Tables, the system restricts calls that you enter only in the Restrict Code Table. Calls entered in both tables are not restricted.) The system provides four tables, with 200 entries (permitted codes) in each table. A permitted code is 12 digits maximum, using 0~9, #, \* and Recall (as a wild card).

- International Call Restriction

International Call Restriction lets you limit the international calls an extension user may dial. You can build a restrict table to prevent only certain calls, or you can build a permit table to allow only certain calls. To allow most international calls, use the International Call Restrict Table. To prevent most international calls, use the International Call Allow Table. The system provides 10 International Call Restrict tables with up to four digits in each table entry and 20 International Call Allow tables, with up to six digits in each table entry. Valid entries are 0~9, #, \* and Recall (as a wild card).

- Code Restriction for Speed Dialing

Speed Dialing can bypass or follow Code Restriction. If you allow many users to program Speed Dialing, consider code restricting the numbers they dial. If only administrators can program Speed Dialing, Code Restriction may not be necessary. You can separately restrict Group and Common Speed Dialing.

- Toll Digit Counting

Use Call Digit Counting to limit the number of digits local callers can dial. You can use this option to prevent users from accessing local dial-up services. For example, set the Maximum Number of Digits in Local Calls to seven to limit local callers to dialing the exchange code (NNX) and local address (nnnn) only. The system provides four tables in which you can make entries for this option. The range is 4~30 digits.

- Code Call Digit Counting

With Code Call Digit Counting, you can limit the number of digits long distance callers can dial. This lets you prevent callers from dialing extensively into long distance dial-up services. You can make four entries (4~30 digits).

- Toll Free Trunks

Certain trunks can be completely unrestricted, such as the company president’s Private Line. Users can place calls on Code Free Trunks anytime – to anywhere, without inadvertently being Code restricted.

- PBX Call Restriction

Code Restriction programming lets you enable/disable PBX Call Restriction and enter PBX access codes. You only need to do this if your system is behind a PBX and you have trunks programmed for behind PBX operation. Refer to [PBX Compatibility on page 2-1281](#) feature for the specifics.

- Additional Default Entries For Common Permit Code Table

Additional entries have been added to the default Common Permit Code Table. The default setting is as follows:

- Table 1: 911
- Table 2: 1800
- Table 3: 1888
- Table 4: 1822
- Table 5: 1833
- Table 6: 1844
- Table 7: 1855
- Table 8: 1866
- Table 9: 1877

- Tie Line Code Restriction Enhanced

In Program **34-01-05: E&M Tie Line Basic Setup – System Code Restriction**, if this option is set to 0, the system follows the setting in Program **21-05-13: Code Restriction Class – Restriction of Tie Line Calls** to determine whether or not the Code restriction setting in Program 34-08 is to be followed. If this option is set to 1, the system follows the system Code restriction settings defined in Program 21-05-01 through Program 21-05-13.

- A user can temporarily override extension Code Restrictions.
- The system allows or denies outgoing access to trunks depending on Code Restriction.
- If the system detects the call is answered by detecting reversal in an analog trunk this restores both – way voice paths immediately.
- When using DISA or Tie Lines, additional programming is required for Code Restriction (DISA, refer to Program 25-10; Tie Lines, refer to Program 34-04).
- A user can temporarily block their extension Code Restriction access, preventing unwanted calls from being placed on their telephone while they are away from their desk.
- Each phone and trunk have a Restriction Class. The higher class applies for outgoing calls.

For example:

- When trunk class is 01 and station class 02, Toll Restriction Class 02 is applied.
- When trunk class is 15 and station class 03, Toll Restriction Class 15 is applied.

## Default Settings

Disabled

## System Availability

### Terminals

All Terminals

### Required Component(s)

None

## Related Features

- ↳ [Central Office Calls, Placing](#)
- ↳ [Code Restriction Override](#)
- ↳ [Code Restriction, Dial Block](#)
- ↳ [Direct Inward System Access \(DISA\)](#)
- ↳ [PBX Compatibility](#)
- ↳ [Multiple Trunk Types](#)

## Guide to Feature Programming

The **Level 1**, **Level 2** and **Level 3** columns indicate the programs that are assigned when programming this feature in the order they are most commonly used. These levels are used with PCPro and WebPro wizards for feature programming.

- Level 1 – these are the most commonly assigned programs for this feature.
- Level 2 – these are the next most commonly assigned programs for this feature.
- Level 3 – these programs are not often assigned and require an expert level working knowledge of the system to be properly assigned.

Program Number	Program Name/Description	Input Data	Default	Level		
				1	2	3
14-01-08	<b>Basic Trunk Data Setup – Toll Restriction</b> For each trunk, enter 1 to Enable Toll Restriction; enter 0 to Disable Code Restriction.	0 = Restriction Disabled (No) 1 = Restriction Enabled (Yes)	1	✓		
15-02-30	<b>Multiline Telephone Basic Data Setup – Toll Restriction Class</b> Select the Toll Restriction Class to be used when placing a call from a virtual extension.	0 = Vir. Ext. (Virtual Extension Class) 1 = Real Ext. (Real Extension Class)	1	✓		

Program Number	Program Name/Description	Input Data	Default	Level		
				1	2	3
20-06-01	<b>Class of Service for Extensions</b> Assign a Class of Service (1 ~ 15) to extensions.	Day Night/Mode: 1 ~ 8 Class of Service of Extensions (1 ~ 15)	Extension port 101 = Class 15 All other extension port = Class 1	✓		
20-08-02	<b>Class of Service Options (Outgoing Call Service) – Trunk Outgoing Calls</b> Turn Off or On outgoing trunk calling for the extension.	0 = Off 1 = On	COS 01 ~ 15 = 1	✓		
20-13-20	<b>Class of Service Options (Supplementary Service) – Account Code/Toll Restriction Operator Alert (Restricted Operation Transfer)</b> Turn Off or On operator alert when an extension improperly enters an Account Code or violates Toll Restriction.	0 = Off 1 = On	COS 01 ~ 15 = 0			✓
21-01-10	<b>System Options for Outgoing Calls – Dial Digits for Toll Restriction Path</b> If this option is programmed with an entry other than 0, a call does not have a talk path unless the user dials at least the number of digits entered in this option when placing an outgoing call.  This means that an entry of 4 or higher in this program causes a problem when dialing 911. Since it is only a 3-digit number, the call does not have a talk path, preventing the emergency dispatcher from hearing the caller. This option should be kept at its default setting of 0 to prevent any problem with dialing 911. If the system detects the call is answered, by detecting Reversal in analog trunks, this restores both – way voice paths immediately.	0 ~ 24	0	✓		
21-01-15	<b>System Options for Outgoing Calls – Outgoing Disable on Incoming Line (Toll Restriction)</b> Enable or Disable the Incoming Line feature system wide. When enabled applies code restriction when hook flash is sent on inbound trunk followed by dialed digits.	0 = Disable 1 = Enable	0		✓	
21-01-16	<b>System Options for Outgoing Calls – Supervise Dial Detection Timer</b> With the Outgoing Disable on Incoming Line feature, if dial tone is not detected after the extension answers an incoming line, the system determines the call is unable to complete and releases the DTMF receiver.	0 ~ 64800 seconds	20		✓	



Program Number	Program Name/Description	Input Data	Default	Level		
				1	2	3
21-01-17	<b>System Options for Outgoing Calls – Restriction Digit in Outgoing Disable on Incoming Line</b> With the Outgoing Disable on Incoming Line feature, determine the number of digits to be dialed before the call should be disconnected.	Digits 1 ~ 9	4		✓	
21-04-01	<b>Toll Restriction Class for Extensions</b> Assign a Toll Restriction class to an extension for modes 1-8.	Day/Night Mode 1 ~ 9 (9 = Power Failure Mode) Restriction Class 1 ~ 15	2	✓		
21-05-01	<b>Toll Restriction Class – International Call Restriction Table</b> For the Toll Restriction Class you select, Assign or Unassign the International Call Restrict Table (Program 21-06-01).	0 = Unassign (No) 1 = Assign (Yes)	1, 6 ~ 15 = 0 2 ~ 5 = 1	✓		
21-05-02	<b>Toll Restriction Class – International Call Permit Code Table</b> For the Toll Restriction Class you select, Assign or Unassign the International Call Permit Table (Program 21-06-02).	0 = Unassign 1 = Assign	1, 3 ~ 15 = 0 2 = 1	✓		
21-05-04	<b>Toll Restriction Class – Maximum Number of Digits Table Assignment</b> Select the table (defined in Program 21-06-03) to be used to determine the maximum number of digits allowed for outgoing calls.	1 ~ 4 = Table 0 = Disable (None)	1, 2, 6 ~ 15 = 0 3 = 1 4 = 2 5 = 3	✓		
21-05-05	<b>Toll Restriction Class – Common Permit Code Table</b> Choose whether the table set up by Program 21-06-04 is referred to, or not referred to.	0 = Unassigned 1 = Assigned	1, 8 ~ 15 = 0 2 ~ 7 = 1	✓		
21-05-06	<b>Toll Restriction Class – Common Restriction Table</b> Choose whether the table set up by Program 21-06-05 is referred to, or not referred to.	0 = Unassigned 1 = Assigned	1, 6 ~ 15 = 0 2 ~ 5 = 1	✓		
21-05-07	<b>Toll Restriction Class – Permit Code Table</b> Set the tables 1 ~ 4 when referring to the table set up by Program 21-06-06.	1 ~ 4 = Table 0 = Disable (None)	1, 2, 6 ~ 15 = 0 3 = 1 4 = 2 5 = 3	✓		
21-05-08	<b>Toll Restriction Class – Restriction Table</b> Set the tables 1 ~ 4 when referring to the table set up by Program 21-06-07.	1 ~ 4 = Table 0 = Disable (None)	0	✓		
21-05-09	<b>Toll Restriction Class – Restriction for Common Speed Dials</b> For the Code Restriction Class you select, Enable (1) or Disable (0) Code Restriction for Common Speed Dialing numbers.	0 = Does Not Restrict 1 = Following Restriction Check	0		✓	

Program Number	Program Name/Description	Input Data	Default	Level		
				1	2	3
21-05-10	<b>Toll Restriction Class – Restriction for Group Speed Dials</b> For the Toll Restriction Class you select, Enable (1) or Disable (0) Code Restriction for Group Speed Dialing numbers.	0 = Does Not Restrict 1 = Following Restriction Check	0		✓	
21-05-11	<b>Toll Restriction Class – Intercom Call Restriction</b> For the Toll Restriction Class you select, Enable or Disable Intercom Call Restriction. If enabled, extensions cannot receive Intercom calls.	0 = Disable 1 = Enable	0		✓	
21-05-12	<b>Toll Restriction Class – PBX Call Restriction</b> For the Toll Restriction Class you select, Enable or Disable PBX Call Restriction.	0 = Disable (No) 1 = Enable (Yes)	1 ~ 6, 8 ~ 15 = 0 7 = 1		✓	
21-05-13	<b>Toll Restriction Class – Restriction of Tie Line Calls</b> Select whether the Toll Restriction set up in Program 34-08-01 is Enabled or Disabled.	0 = Disable 1 = Enable	0		✓	
21-06-01	<b>Toll Restriction Table Data Setup – International Call Restriction Table</b> Enter the international dialing codes you want to restrict.	A maximum of four digits to be assigned.	Tables 1 ~ 10 = No Setting	✓		
21-06-02	<b>Toll Restriction Table Data Setup – International Call Permit Code Table</b> Enter the international dialing codes you want to permit.	Dial (maximum of six digits)	Tables 1 ~ 20 = No Setting	✓		
21-06-03	<b>Toll Restriction Table Data Setup – Maximum Number of Digits Table Assignment</b> Select the maximum number of digits allowed in outgoing calls for each table (4 ~ 30).	4 ~ 30 = 4 ~ 30 digits	Tables 1 ~ 4 = 30	✓		
21-06-04	<b>Toll Restriction Table Data Setup – Common Permit Code Table</b> Program codes into the Common Permit Code Table.	Dial (maximum of four digits)	Table 1 = 911 Table 2 = 1800 Table 3 = 1888 Table 4 = 1822 Table 5 = 1833 Table 6 = 1844 Table 7 = 1855 Table 8 = 1866 Table 9 = 1877 Table 10 = No Setting	✓		
21-06-05	<b>Toll Restriction Table Data Setup – Common Restriction Table</b> Program codes into the Common Restrict Code Table.	Dial (maximum of 12 digits)	Table 1 = 900 Table 2 = 1900 Table 3 = 976 Tables 4 ~ 10 = No Setting	✓		

Program Number	Program Name/Description	Input Data	Default	Level		
				1	2	3
21-06-06	<b>Toll Restriction Table Data Setup – Permit Code Table</b> Program codes into the Permit Code Tables.	Dial (maximum of 12 digits)	Table 1 ~ 4 = No Setting	✓		
21-06-07	<b>Toll Restriction Table Data Setup – Deny Restriction Table</b> Program codes into the Restrict Code Tables (200 codes per table maximum).	Dial (maximum of 12 digits)	Table 1 ~ 4 = No Setting	✓		
21-06-08	<b>Toll Restriction Table Data Setup – PBX Access Code</b> The system allows up to four tables for PBX access codes. PBX Access Codes can have up to two digits, using 0~9, #, * and LINE KEY 1 (don't care). Refer to <a href="#">PBX Compatibility on page 2-1281</a> for the specifics.	Dial (maximum of 2 digits)	Table 1 ~ 4 = No Setting	✓		
21-21-01	<b>Toll Restriction for Trunks (Seized Trunk Basis Setting) – Restriction Class</b> Enter the Toll Restriction Class for the selected trunk.	1 ~ 15	1		✓	
34-01-05	<b>E&amp;M Tie Line Basic Setup – System Toll Restriction</b> Determine if an incoming Tie Line call should be subject to Toll Restriction.	0 = No (Off) 1 = Yes (On)	0		✓	
34-08-01	<b>Toll Restriction Data for E&amp;M Tie Lines</b> Define the Toll Restriction data for E&M Tie Lines. This data should be defined if Tie Line Code Restriction is enabled in Program 21-05-13.	Maximum of 10 digits (0~9, *, #)	No Setting		✓	
35-02-01	<b>SMDR Output Options – Toll Restricted Call</b> SMDR can include or exclude calls blocked by Toll Restriction.	0 = Not Displayed 1 = Displayed	1		✓	

## Operation

### To place a trunk call if your system is Code Restricted:

1. Place call normally.
  - ◇ If your Code Restriction Class does not allow the number you dial, your call is cut off.

## Code Restriction Override

### Description

Code Restriction Override lets a user temporarily bypass the Code Restriction for an extension. This helps a user that must place an important call that Code Restriction normally prevents. For example, you could set up Code Restriction to block 900 calls and then provide a Code Restriction Override code to your attendant and executives. When the attendant or executive needs to place a 900 call, they just:

- Press **Speaker**, dial a service code, and enter their override code.
- Press **Speaker** and dial a trunk access code (e.g., 9 or #9 002).
- Place the 900 call without restriction

You can assign a different Code Restriction Override code to each extension. Or, extensions can share the same override code.

Code Restriction Override bypasses *all* Code Restriction programming. Walking Code Restriction allows you to assign a Code Restriction level for each user. When a call is placed using Walking Code Restriction, the restriction for the call is based on the Code Restriction level defined in Programs 21-05-xx and Programs 21-06-xx.

### Conditions

- Off-Premise notification and external extensions require access to outside lines.
- In the Class heading in the SMDR report, POTA indicates that the call was placed using Temporary Code Restriction Override.
- Code Restriction Override and Walking Code Restriction temporarily overrides an extension Code Restriction.
- If the system has VRS, users hear, "Your call cannot go through. Please call the operator" when they dial a number that Code Restriction prevents.

### Default Settings

Disabled

### Related Features

- ➔ [Central Office Calls, Placing](#)
- ➔ [Code Restriction](#)
- ➔ [Station Message Detail Recording](#)
- ➔ [Voice Response System \(VRS\)](#)

## Guide to Feature Programming

The **Level 1**, **Level 2** and **Level 3** columns indicate the programs that are assigned when programming this feature in the order they are most commonly used. These levels are used with PCPro and WebPro wizards for feature programming.

- Level 1 – these are the most commonly assigned programs for this feature.
- Level 2 – these are the next most commonly assigned programs for this feature.
- Level 3 – these programs are not often assigned and require an expert level working knowledge of the system to be properly assigned.

Program Number	Program Name/Description	Input Data	Default	Level		
				1	2	3
11-11-34	<b>Service Code Setup (for Setup/Entry Operation) – Temporary Toll Restriction Override</b> If required, change the service code (775) for Temporary Toll Restriction Override.	MLT, SLT 0 ~ 9, *, # Maximum of eight digits	775		✓	
11-11-36	<b>Service Code Setup (for Setup/Entry Operation) – Toll Restriction Override</b> If required, change the service code (663) for Toll Restriction Override.	MLT, SLT 0 ~ 9, *, # Maximum of eight digits	663		✓	
20-08-06	<b>Class of Service Options (Outgoing Call Service) – Toll Restriction Override</b> Turn Off or On Toll Restricting Override (Service Code 775).	0 = Off 1 = On	COS 01 ~ 15 = 0	✓		
21-01-07	<b>System Options for Outgoing Calls – Toll Restriction Override Time</b> Set the Toll Restriction Override Time. After dialing the Toll Restriction Override codes, the system removes Toll Restriction for this Time.	0 ~ 64800 seconds	10	✓		
21-07-01	<b>Toll Restriction Override Password Setup</b> Assign Toll Restriction Override codes to extensions. Each code must have four digits, using any combination of 0 ~ 9, # and *. Each extension can have a separate code, or many extensions can share the same override code.	Maximum four digits (0 ~ 9, #, *)	No Setting	✓		
21-14-01	<b>Walking Toll Restriction Password Setup – User ID</b> Enter the Walking Toll Restriction Override User ID codes (six digits) into tables. Up to 500 different override codes can be entered.	Dial (Six digits)	No Setting	✓		
21-14-02	<b>Walking Toll Restriction Password Setup – Walking Toll Restriction Class Number</b> Enter the Walking Toll Restriction Class of Service (1 ~ 15) to be used for each table number assigned in Program 21-14-01.	1 ~ 15	1	✓		

Program Number	Program Name/Description	Input Data	Default	Level		
				1	2	3
35-02-01	<b>SMDR Output Options – Toll Restricted Call</b> SMDR can include or exclude calls blocked by Toll Restriction.	0 = Not Displayed 1 = Displayed	1		✓	
35-02-02	<b>SMDR Output Options – PBX Calls</b> When the system is behind a PBX, SMDR can include all calls or just calls dialed using the PBX trunk access code.	0 = Not Displayed 1 = Displayed	1		✓	
35-02-03	<b>SMDR Output Options – Trunk Number or Name</b> Select whether the system should display the trunk Name (0) or the Number (1) on SMDR reports. ➤ If this option is set to 0, Program 35-02-14 must be set to 0.	0 = Name 1 = Number	1		✓	
35-02-04	<b>SMDR Output Options – Summary (Daily)</b> Set this option to (1) to have the SMDR report provide a daily summary (at midnight every night).	0 = Not Displayed 1 = Displayed	1		✓	
35-02-05	<b>SMDR Output Options – Summary (Weekly)</b> Set this option to (1) to have the SMDR report provide a weekly summary (every Saturday at midnight).	0 = Not Displayed 1 = Displayed	1		✓	
35-02-06	<b>SMDR Output Options – Summary (Monthly)</b> Set this option to (1) to have the SMDR report provide a monthly summary (at midnight on the last day of the month).	0 = Not Displayed 1 = Displayed	1		✓	
35-02-07	<b>SMDR Output Options – Toll Charge Cost</b> Set this option to (1) have the SMDR report include toll charges.	0 = Not Displayed 1 = Displayed	1		✓	
35-02-08	<b>SMDR Output Options – Incoming Call</b> Enable this option (1) to have the SMDR report include incoming calls. If you disable this option (0), incoming calls do not print.	0 = Not Displayed 1 = Displayed	1		✓	
35-02-09	<b>SMDR Output Options – Extension Number or Name</b> Set this option (1) to have the SMDR report include extension numbers. Set this option (0) to have the SMDR report include extension names.	0 = Name 1 = Number	1		✓	
35-02-10	<b>SMDR Output Options – All Lines Busy (ALB) Output</b> Determine if the All Lines Busy (ALB) indication should be displayed.	0 = Not Displayed 1 = Displayed	0		✓	
35-02-12	<b>SMDR Output Options – DID Table Name Output</b> Determine if the DID table name should be displayed.	0 = Not Displayed 1 = Displayed	0		✓	

Program Number	Program Name/Description	Input Data	Default	Level		
				1	2	3
35-02-13	<b>SMDR Output Options – CLI Output When DID to Trunk</b> Determine if the CLI output should be displayed for DID.	0 = Not Displayed 1 = Displayed	0		✓	
35-02-14	<b>SMDR Output Options – Date</b> Determine whether the date should be displayed on SMDR reports. ➤ <i>This option must be set to 0 if the trunk name is set to be displayed in Program 35-02-03.</i>	0 = Not Displayed 1 = Displayed	0		✓	
35-02-15	<b>SMDR Output Options – CLI/DID Number Switching</b> Determine whether or not the CLI/DID Number Switching should be displayed.	0 = CLI (CLIP) 1 = DID Calling Number 2 = Caller ID Name	0		✓	
35-02-16	<b>SMDR Output Options – Trunk Name or Received Dialed Number</b> Determine how the SMDR should print incoming calls on ANI/DNIS or DID trunks. If set to (1), ANI/DNIS trunks can print DNIS digits. If set to (0) trunk names are printed instead.	0 = Trunk Port Name 1 = Received Dialed Number	0		✓	
35-02-17	<b>SMDR Output Options – Print Account Code or Caller Name of Incoming Call</b> Determine if SMDR should print Account Code or Caller Name of Incoming Call.	0 = ACC 1 = CNAME	0		✓	
35-02-18	<b>SMDR Output Options – Print Mode for Caller Name of Incoming Call</b> Determine how SMDR should print Caller Name of Incoming Call.	0 = Normal 1 = Line Feed	0		✓	

### Walking Code Restriction

#### Walking Toll Restriction

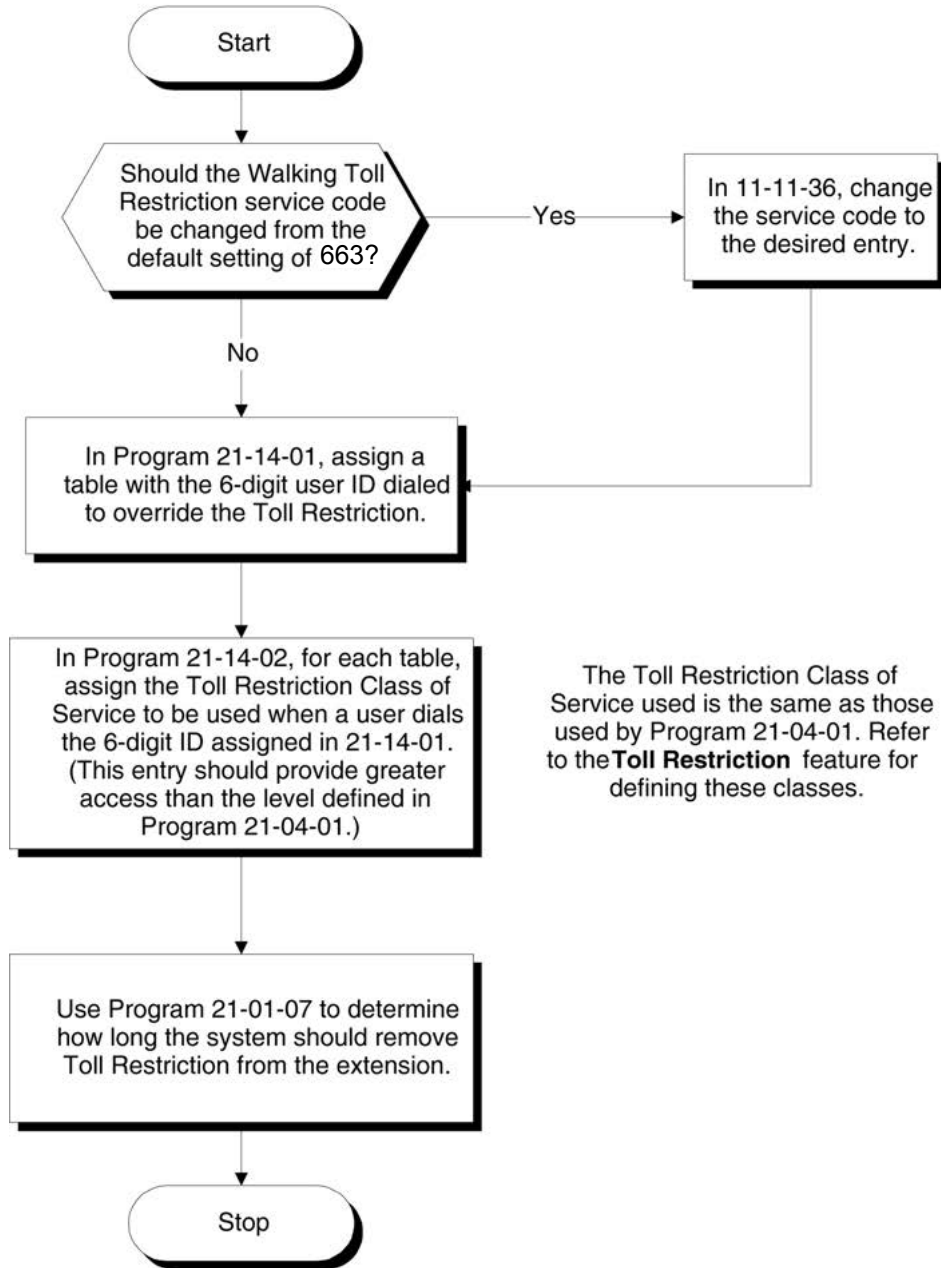



### Temporary Code Restriction Override

#### Temporary Toll Restriction Override

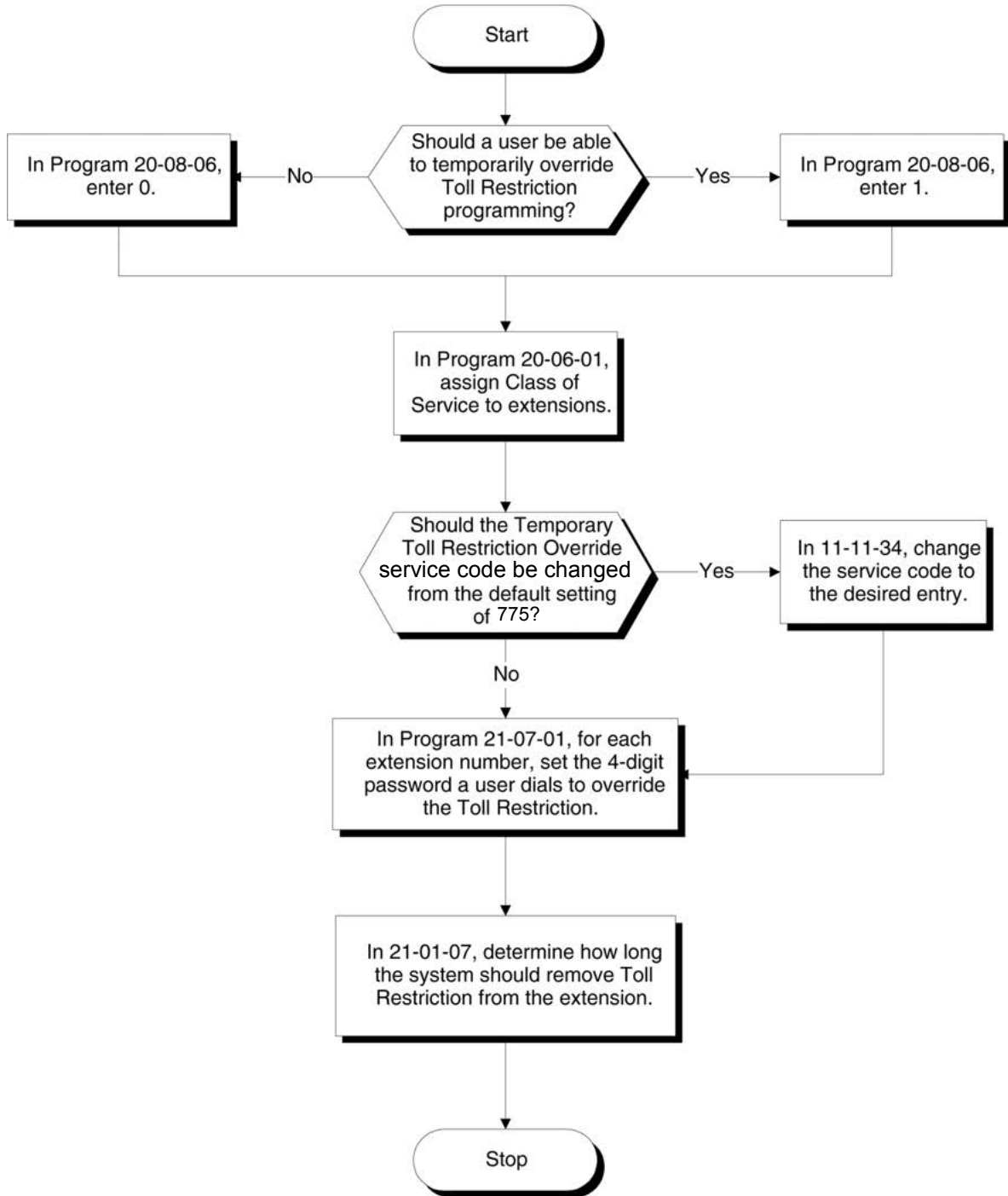

## Operation

### To temporarily override a restricted extension Code Restriction:



*You can override restriction for only one call at a time.*

NOTE

1. At the multiline terminal, press **Speaker**.  
 - OR -  
 At single line telephone, lift the handset.
2. Dial **775**.
3. Dial the 4-digit Code Restriction Override code.
  - ◇ *If you wait too long before going to the next step, you may have to repeat the procedure. After dialing the service code, the display indicates the override codes as they are being entered. As the last digit is entered, the display is cleared and ICM dial tone is heard.*
  - ◇ *You hear error tone if you dial your code incorrectly.*
4. Press idle line key or dial trunk access code.
5. Dial the number without any restriction.

### To use your Walking Code Restriction level at an extension:



*You can override restriction for only one call at a time.*

NOTE

1. At the multiline terminal, press **Speaker**.  
 - OR -  
 At the single line telephone, lift the handset.
2. Dial **663** and dial the 6-digit user ID for Walking Toll Restriction.
  - ◇ *After dialing the service code, the display indicates the override codes as they are being entered. As the last digit is entered, the display is cleared and ICM dial tone is heard.*
  - ◇ *You hear error tone if you dial your code incorrectly.*
3. Press idle line key or dial trunk access code.
4. Dial the number.
  - ◇ *The call is allowed or denied based on the user's Toll Restriction Class of Service level.*

## Code Restriction, Dial Block

### Description

Code Restriction, Dial Block lets a user temporarily block dialing on an extension. This helps a user block his or her phone from being used by another person while they are away from their desk. A user must enter a 4-digit personal code to enable/disable this feature.

Dial Block can also be set by the supervisor's access code. If Dial Block is set by an extension user, the supervisor cannot release it. If Dial Block is set by the supervisor's code, the extension user cannot release it.

*Important:* This function works by password and Class of Service control (the supervisor is not an assigned extension). If Dial Block is available for all Classes of Service, everyone may become a supervisor if they know the Dial Block password.

### Conditions

- If the system is reset by a first initialize, the Dial Block feature is cleared.
- This feature is not available for ISDN S-Bus extensions.
- Both Program 21-09-01 (Code Restrict Class) and Program 21-10 (Dial Block Restriction Class per Extension) can be set at the same time. However the system gives priority to the setting in Program 21-10.
- Dial Block can temporarily block an extension Code Restriction setting by changing to a predefined table that has more restrictions.

### Default Settings

Disabled

### System Availability

#### Terminals

None

#### Required Component(s)

None

## Related Features

None

## Guide to Feature Programming

The **Level 1**, **Level 2** and **Level 3** columns indicate the programs that are assigned when programming this feature in the order they are most commonly used. These levels are used with PCPro and WebPro wizards for feature programming.

- Level 1 – these are the most commonly assigned programs for this feature.
- Level 2 – these are the next most commonly assigned programs for this feature.
- Level 3 – these programs are not often assigned and require an expert level working knowledge of the system to be properly assigned.

Program Number	Program Name/Description	Input Data	Default	Level		
				1	2	3
11-10-17	<b>Service Code Setup (for System Administration) – Dial Block by Supervisor</b> Assign a service code used by the supervisor to set Dial Block for another extension.	MLT 0 ~ 9, *, # Maximum of eight digits	601		✓	
11-11-33	<b>Service Code Setup (for Setup/Entry Operation) – Dial Block</b> Assign a service code to use for Dial Block.	MLT, SLT 0 ~ 9, *, # Maximum of eight digits	600		✓	
20-06-01	<b>Class of Service for Extensions</b> Assign a Class of Service (1 ~ 15) to extensions.	Day Night/Mode: 1 ~ 8 Class of Service of Extensions (1 ~ 15)	Extension port 101 = Class 15 All other extension port = Class 1	✓		
20-08-08	<b>Class of Service Options (Outgoing Call Service) – Toll Restriction Dial Block</b> Turn Off or On an extension user ability to use Dial Block.	0 = Off 1 = On	COS 1 ~ 15 = 0	✓		
21-07-01	<b>Toll Restriction Override Password Setup</b> Assign Toll Restriction Override codes to extensions. Each code must have four digits, using any combination of 0 ~ 9, # and *. Each extension can have a separate code, or many extensions can share the same override code.	Maximum of four digits (fixed)	No Setting	✓		
21-09-01	<b>Dial Block Setup – Toll Restriction Class with Dial Block</b> Assign a Code Restriction COS (1 ~ 15) when the Dial Block feature is used.	1 ~ 15	15	✓		
21-09-02	<b>Dial Block Setup – Supervisor Password</b> Assign a 4-digit password used by the supervisor to enable or disable Dial Block for other extensions.	0 ~ 9, *, # (4-digit fixed)	No Setting	✓		

Program Number	Program Name/Description	Input Data	Default	Level		
				1	2	3
21-10-01	<b>Dial Block restriction Class per Extension</b> Assign the Code Restriction COS (1 ~ 15) used by an extension when the Dial Block feature is enabled. If this data is 0, Code Restriction COS follows Program 21-09-01.	0, 1 ~ 15 (0 = No Setting)	0	✓		
90-19-01	<b>Dial Block Release</b> Enter the extension number to release from the Dial Block Restriction. This program can be used when a password is forgotten by the user.	[Release?]: Dial 1+ press <b>Transfer</b> (Press <b>Transfer</b> to cancel.)	No Setting		✓	

## Operation

### To set Dial Block:

1. At the multiline terminal, press **Speaker**.  
- OR -  
At the single line telephone, lift the handset.
2. Dial **600** (default).
3. Dial the 4-digit Dial Block Code (as set in programming).
4. Dial **1**.  
◇ *Confirmation tone is heard.*
5. Press **Speaker** or replace the handset to hang up.

### To release Dial Block:

1. At the multiline terminal, press **Speaker**.  
- OR -  
At the single line telephone, lift the handset.
2. Dial **600**.
3. Dial the 4-digit Dial Block code.
4. Dial **0**.  
◇ *Confirmation tone is heard.*
5. Press **Speaker** or replace the handset to hang up.

**To set Dial Block from another extension:**

1. At the multiline terminal, press **Speaker**.  
- OR -  
At the single line telephone, lift the handset.
2. Dial **601** (default).
3. Dial the 4-digit Dial Block code (as set in programming).
4. Dial the extension number to blocked.
5. Dial **1**.  
◇ *Confirmation tone is heard.*
6. Press **Speaker** or replace the handset to hang up.

**To release Dial Block from another extension:**

1. At the multiline terminal, press **Speaker**.  
- OR -  
At the single line telephone, lift the handset.
2. Dial **601**.
3. Dial the 4-digit Dial Block code.
4. Dial the extension number to be released from Dial Block.
5. Dial **0**.  
◇ *Confirmation tone is heard.*
6. Press **Speaker** or replace the handset to hang up.

## Conference

### Description

Conference lets an extension user add additional inside and outside callers to their conversation. With Conference, a user can set up a multiple-party telephone meeting without leaving the office. The GCD-CP10 provides 64 (96 when the analog modem function is not used) conference ports, to allow any number of internal or external parties to be conferenced together for a limit of 32 parties. This means that one extension can conference up to 31 internal and/or external parties together (the originator would be the 32nd party reaching the maximum of 32). While this Conference call is active, another user can initiate a separate Conference also for a limit of 32 parties, or any number of conferences can be initiated with any number of parties (up to 32) until all 64 Conference ports are busy.

### Conditions

- 96 conference ports are available when the analog modem function is not used.
- An ADA module is required for speech recording.
- Split allows a user to alternate (i.e., switch) between their callers in Conference. This allows a dispatcher, for example, to control a telephone meeting between themselves, a customer and a service technician. The dispatcher can meet together with all parties, privately set up a service strategy with the technician and then meet again to set the schedule.
- Split cycles through the Conference in the same order in which the Conference was initially set up. If a user places an outside call, conferences extension 101 followed by extension 102, Split cycles from the trunk, to 101 and finally to 102. The Split cycle then repeats.
- If a user's extension has Barge-In enabled, they can also Barge-In on an established Conference. This permits, for example, an attendant or supervisor to join a Conference in an emergency. It also allows a co-worker to leave a conference – and then rejoin the telephone meeting when it is convenient to do so.
  - ◇ *If a user's extension has Barge-In monitor enabled (Program 20-13-10), they can Silent Monitor a conference already in progress (Program 99-01-49 option 49 must be set to 1).*
- A Class of Service option is available which allows or denies an extension user from automatically setting up a Conference/Tandem Trunking call upon hanging up the telephone.
- An extension with Barge-In enabled can Transfer a call to an existing Conference. This allows, for example, an attendant to locate co-workers and then Transfer them to an existing telephone meeting. There is no need for the attendant to locate all the parties at the same time and sequentially add them into the Conference. Transfer Call Into Conference Code (624).

- An option is available which allows an extension Conf key (SC 751: 07) to be programmed for Conference or for Transfer. When set for Transfer, the user places a call on hold, dials the extension to which it should be transferred, and presses Conf. The call is then transferred. When set for Conference, with an active call, the user presses Conf, places a second call, then presses Conf twice. All the calls are then connected.
- Users can Barge-In on a Conference call if allowed in programming.
- Define the outgoing call options for each trunk and user.
- Set up a Conference with a co-worker in your immediate work area.
- DISA and Tie Line users may use the Barge-In feature on a Conference call if they know the service code and are permitted in their DISA/Tie Line Class of Service.
- Meet Me Conference lets an extension user set up a Conference via Paging.
- Meet Me Paging lets an extension user set up a two-party meeting via Paging.
- A user can set up an Unsupervised Trunk-to-Trunk Conference and then drop out of the call, allowing the remaining parties to continue the conversation. Establish two trunk calls, press Hold and dial #8.
- You can optionally program Conf (Transfer) for Transfer. In this case, the multiline terminal must have a Conference function key. The system also allows a call to be transferred into a Conference call.
- When the Conference Originator hangs up with a conference on Hold, or when trying to add another caller, all internal calls are dropped.
- Conferencing when talking on a Virtual Extension:
  - ❑ While talking on a Virtual Extension, if the station has an internal call on Hold, a conference call cannot be established.
  - ❑ While talking on a Virtual Extension, if the station receives an intercom call (call to its actual station number), a conference call cannot be established.
  - ❑ While talking on a Virtual Extension, if the station has a call on Hold, a conference call cannot be established.

## Default Settings

Enabled

## System Availability

### Terminals

All Terminals



## Required Component(s)

None

## Related Features

None

## Guide to Feature Programming

The **Level 1**, **Level 2** and **Level 3** columns indicate the programs that are assigned when programming this feature in the order they are most commonly used. These levels are used with PCPro and WebPro wizards for feature programming.

- Level 1 – these are the most commonly assigned programs for this feature.
- Level 2 – these are the next most commonly assigned programs for this feature.
- Level 3 – these programs are not often assigned and require an expert level working knowledge of the system to be properly assigned.

Program Number	Program Name/Description	Input Data	Default	Level		
				1	2	3
11-12-08	<b>Service Code Setup (for Service Access) – Barge-In</b> Determine what the service code should be for an internal party to use the Barge-In feature.	MLT, SLT 0 ~ 9, *, # Maximum of eight digits	710		✓	
11-12-47	<b>Service Code Setup (for Service Access) – Call Waiting Answer/Split Answer</b> If required, change the code users dial to Split while on a call.	SLT 0 ~ 9, *, # Maximum of eight digits	794		✓	
11-12-57	<b>Service Code Setup (for Service Access) – Tandem Trunking</b> With two trunks in Conference press Hold and dial #8 and the Conference/Tandem happens.	MLT, SLT 0 ~ 9, *, # Maximum of eight digits	#8		✓	
11-12-58	<b>Service Code Setup (for Service Access) – Transfer Into Conference</b> If required, change the service code used to transfer a call into a Conference call.	MLT, SLT 0 ~ 9, *, # Maximum of eight digits	624		✓	
11-16-02	<b>Single Digit Service Code Setup – Barge-In</b> Customize the one-digit Service Codes used for Barge-In.	0 ~ 9, *, # Maximum of one digit	No Setting		✓	
14-01-04	<b>Basic Trunk Data Setup – Transmit Gain Level for Conference and Transfer Calls</b> Select the CODEC gain type used by the trunk when it is part of an unsupervised conference.	1 ~ 57 (-15.5 dB ~ +12.5 dB in 0.5 dB intervals)	32 (0 dB)			✓

Program Number	Program Name/Description	Input Data	Default	Level		
				1	2	3
15-02-24	<p><b>Multiline Telephone Basic Data Setup – Conference Key Mode</b></p> <p>Allow an extension Conf key to be programmed for Conference or for Transfer. When set for Transfer, the user places a call on hold, dials the extension to which it should be transferred, then presses the Conf key. The call is then transferred. When set for Conference, with an active call, the user presses the Conf key, places a second call, then presses the Conf key twice. All the calls are then connected.</p> <p>➡ <i>This program is for UX5000 terminals only.</i></p>	0 = Conference 1 = Transfer	0	✓		
15-07-01	<p><b>Programmable Function Keys</b></p> <p>Assign functions to multiline terminal line keys.</p>	Line Key 1 ~ 48 0 ~ 99 (Normal Function Code 751 by default) *00 ~ *99 (Appearance Function Code) (Service Code 752 by default)	Refer to the Programming Manual for default values.	✓		
20-03-01	<p><b>System Options for Single Line Telephones – SLT Call Waiting for Answer Mode</b></p> <p>For a busy single line (500/2500 type) telephone, set the mode used to answer a camped-on trunk call.</p> <p>For ESL sets, enabling this option (1) allows the user to dial Service Code for Voice Mail Conversation Record.</p>	0 = Hookflash (Hooking) 1 = Hookflash + Service Code 794 ➡ <i>Service Code 654 is for Live Recording at SLT (Program 11-12-53).</i>	0		✓	
20-06-01	<p><b>Class of Service for Extensions</b></p> <p>Assign a Class of Service (1 ~ 15) to extensions.</p>	Day Night/Mode: 1 ~ 8 Class of Service of Extensions (1 ~ 15)	Extension port 101 = Class 15 All other extension port = Class 1	✓		
20-11-21	<p><b>Class of Service Options (Hold/Transfer Service) – Restriction for Tandem Trunking on Hang Up</b></p> <p>Allow/Deny an extension users' ability to set up a tandem/conference call automatically when they hang up.</p>	0 = Allow 1 = Deny	COS 1 ~ 15 = 0	✓		
20-13-08	<p><b>Class of Service Options (Supplementary Service) – Conference</b></p> <p>Turn Off or On an extension user ability to initiate a conference or Meet Me Conference.</p>	0 = Off 1 = On	COS 1 ~ 15 = 1	✓		
20-13-10	<p><b>Class of Service Options (Supplementary Service) – Barge-In Monitor</b></p> <p>Enable the Barge-In Speech Mode or Monitor Mode at the initiating extension (i.e., Barge-In initiator).</p>	0 = Speech 1 = Monitor	COS 1 ~ 15 = 0		✓	
20-13-15	<p><b>Class of Service Options (Supplementary Service) – Barge-In, Initiate</b></p> <p>Turn Off or On an extension user ability to barge-in on other's calls.</p>	0 = Off 1 = On	COS 1 ~ 15 = 0		✓	

Program Number	Program Name/Description	Input Data	Default	Level		
				1	2	3
20-13-16	<b>Class of Service Options (Supplementary Service) – Barge-In, Receive</b> Turn Off or On Barge-In at the receiving extension (i.e., Barge-In receive).	0 = Off 1 = On	COS 1 ~ 15 = 0		✓	
20-14-11	<b>Class of Service Options for DISA/E&amp;M – DISA/Tie Trunk Barge-In</b> Enable (1)/Disable (0) a DISA or tie trunk user from using the Barge-In feature.	0 = Off 1 = On	COS 1 ~ 15 = 0		✓	

## Operation

### To establish a Conference:

#### Multiline Terminal

1. Establish intercom or trunk call.
2. Press **Conf** or **Conf** softkey (Program 15-07 or SC 751: 07).
3. Dial the extension you want to add.  
  - OR -
 Access outside call.  
  - OR -
 Retrieve call from Park orbit.
  - ◇ *To get the outside call, you can either press a line key or press the Speaker key and dial 9, the Trunk Access Code + the trunk number (default #9). You can optionally go back to step 2 to add more parties to your Conference.*
4. When called party answers, press the **Add** softkey or **Conf** twice.
  - ◇ *If you cannot add additional parties to your Conference, you have exceeded the system Conference limit.*
  - ◇ *If the call being added is busy/unanswered:  
With an outside call, press the line or Call Appearance (CAP) key for a call previously added to the Conference. The unanswered call drops and the initiator is back into the Conference call.*
  - ◇ *Adding an Intercom call to an outside Conference call: Press the **Conf** softkey on the multiline terminal display or Conf twice to re-establish the Conference. If using a non-display telephone, press **Conf** twice.*
  - ◇ *With only Intercom calls in the Conference: Press **Conf** twice to re-establish the Conference. If the voice mail answers, there is no way to drop that extension out. You must drop the Conference call.*
5. Repeat steps 2~4 to add more parties.

### Single Line Telephone

1. Establish Intercom or trunk call.
2. Hookflash and dial **#1**.
3. Dial extension you want to add.  
- OR -  
Access trunk call.  
- OR -  
Retrieve call from Park orbit.
4. Hookflash and repeat step 3 to add more parties.  
- OR -  
Hookflash twice to set up the Conference.

### To Split (alternate) between the parties in Conference:

#### Multiline Terminal

1. Press **Conf (Transfer)** or **Conference** key (Program 15-07 or SC 751: 07).
2. Dial Split service code (**794**).
  - ◇ *Repeat this procedure to alternate between the remaining parties in the Conference. Press the **Conf** softkey or press **Conf** twice to set up the Conference again.*

#### Single Line Telephone

1. Hookflash and dial **794**.
  - ◇ *Repeat this procedure to alternate between the remaining parties in the Conference. Hookflash twice to set up the Conference again.*

### To drop an outside call from the Conference:

1. Press **Hold** to place the conference call on hold.
2. Hang up.
  - ◇ *The lines involved in the Conference ring back separately to the telephone.*
3. Answer and disconnect the unwanted outside call.
4. To re-establish the Conference, answer the remaining call by pressing **Conf** after each call is answered. Press **Conf** twice when all calls have been answered.

### To exit a Conference with internal and outside conference members without affecting the other parties:

#### Multiline Terminal

1. Hang up.
  - ◇ *If you press Hold while on a call with two outside callers, the outside callers hear what is programmed in Program 10-04-01.*

#### Single Line Telephone

1. Hang up.
  - ◇ *If you are not permitted to use Tandem Trunking, outside callers may hear Music on Hold.*

### To exit a Conference when all conference members are outside parties without affecting the other parties:

#### Multiline Terminal

1. Press Hold key.
2. Dial # 8.
3. Hang up.

#### Single Line Telephone

1. Hookflash and dial # 8.
2. Hang up.

### To Barge-In to Conference Call:

1. Pick up the handset or press **Speaker** and dial the service code (default = **710**).
  - ◇ *If the telephone does not have the proper COS, a warning tone is sent. After the user hangs up, the system automatically places a Callback to the extension.*
2. Dial the extension number or press a **DSS** key of a telephone within a Conference call.
  - ◇ *When a new call is added to the conference, an intrusion tone is heard by all parties in the Conference, depending on system programming, and all display multiline terminals show the joined party. If a Conference is not possible:*
    - the extension user hears a warning tone*
    - the DISA user is rerouted to the defined ring group*
  - OR -
  - the Tie Line user hears a busy tone.*

The following steps are not available for DISA or Tie Line trunks:

1. Dial the extension number of the internal party.
2. Dial the single digit service code, if programmed.
  - ◇ *Instead of the single digit service code, the service code 710 can also be dialed at this point.*

**To Transfer a Call into a Conference:**

1. While on a call, press **Hold**.
2. Dial the Transfer to Conference service code (default = **624**).
  - ◇ *If the telephone does not have the proper COS, a warning tone is sent. After the user hangs up, the system automatically places a Callback to the extension.*
  - ◇ *The display shows the line Number, Number/Name and Extension Name/Number.*
3. Dial the extension number or press a **DSS** key of a telephone in a Conference call.
  - ◇ *If an error tone is heard, Barge-In is not enabled for the extension and the call cannot go through. Retrieve the call by pressing the flashing line or Call Appearance (CAP) Key or hang up and the call recalls the extension.*
  - ◇ *When the call is transferred into the Conference, an intrusion tone is heard by all parties in the conference, depending on the entries in Program 20-13-17 and Program 80-01, and all display multiline terminals show the joined party.*
  - ◇ *To cancel the transfer, press the flashing line or Call Appearance (CAP) Key to retrieve the call.*
4. Hang up.

## Conference – Remote

### Description

The Remote Conference feature enhances the built in conference capabilities of the SV9100 by allowing outside parties to dial a Remote Conference pilot number and password to connect to a Conference call. The conference circuits on the CPU are used to join each party to the conference. A maximum of 32 conference participants is possible for one Conference.

A maximum of 20 simultaneous Remote Conference calls are possible with proper licensing and available conference resources. In addition, the conference call can be password protected so that any user joining the conference would be required to enter a password before being connected.

### Conditions

- Transferring a call to a Remote Conference from a uMobility extension is not supported.
- The Barge-In feature cannot be used when an extension is on a Remote Conference call.
- The Remote Conference pilot number cannot be set as the destination for Call Forward.
- A Remote Conference participant cannot place the conference call on Hold.
- The maximum number of system conference resources is 96. If the built in modem functionality is enabled this is reduced to 64.
- Each extension or trunk needs one conference channel to participate in a conference.
- The maximum number of participants per Remote Conference is 32 if conference resources are available.
- A maximum of 20 simultaneous Remote Conferences are possible if conference resources are available.
- A total of 96 combined callers can participate in Remote Conferences if conference resources are available and the built in modem is disabled.
- A conference call cannot be split over the CPU's conference blocks.
- When joining a conference a busy tone will be heard if the maximum number of Remote Conference participants has been reached or if a conference resource is not available.
- As the conference time limit nears, the system will provide a warning tone to all participants based on Program 20-34-05. Once this timer expires, if the conference is still ongoing, the participants will be disconnected by the system.
- If an incorrect password is entered a warning tone is heard and the caller must hang up and dial back into the conference pilot.
- One Remote Conference license (0047) is required for each Remote Conference.

- A VRS license (1001) is required for the Remote Conference **only** if you are going to password protect the conference as VRS is used to play the “please enter your password” prompt. At default, remote conferences are set to prompt for a password in Program 20-34-06 and conferences 1-4 have passwords set. If you set the conference to 1 (Skip) in Program 20-34-06 you do not need the VRS license but still need the remote conference license (0047).
- If Program 20-34-06 is set to normal and no VRS license exists in the system you will get ring no answer (RNA) when calling the Remote Conference pilot.

## Default Settings

None

## System Availability

### Terminals

All Terminals

### Required Component(s)

- 0047 – SV9100 Remote Conf Lic
- 0411 – SV9100 Version Lic (R1)
- 1001 – SV9100 InMail VRS Port Lic, required if remote conferences will be password protected.
- 0413 – SV9100 Version Lic (R3), required to Transfer to a Remote Conference.

## Related Features

➔ [Simple MCU Video](#)

## Guide to Feature Programming

The **Level 1**, **Level 2** and **Level 3** columns indicate the programs that are assigned when programming this feature in the order they are most commonly used. These levels are used with PCPro and WebPro wizards for feature programming.

- Level 1 – these are the most commonly assigned programs for this feature.
- Level 2 – these are the next most commonly assigned programs for this feature.
- Level 3 – these programs are not often assigned and require an expert level working knowledge of the system to be properly assigned.



Program Number	Program Name/Description	Input Data	Default	Level		
				1	2	3
11-19-01	<b>Remote Conference Group Pilot Number</b> Enter the pilot number for remote conference.	Must work within current system dialing plan.	No Setting	✓		
14-01-03	<b>Basic Trunk Data Setup – Receive Level</b> Use this option to select the CODEC gain for the trunk. The option sets the gain (signal amplification) for the trunk you are programming	Trunks 1~400 1 ~ 57 (-15.5 ~ +12.5dB in 0.5dB intervals)	32 (0dB)		✓	
14-01-04	<b>Basic Trunk Data Setup – Transmit Gain Level for Conference and Transfer Calls</b> Use this option to select the CODEC gain type used by the trunk when it is part of an Unsupervised Conference.	1 ~ 57 (-15.5dB ~ +12.5dB in 0.5dB intervals)	32 (0 dB)		✓	
14-01-05	<b>Basic Trunk Data Setup – Receive Gain Level for Conference and Transfer Calls</b> Use this option to select the CODEC gain type used by the trunk when it is part of an Unsupervised Conference.	1 ~ 57 (-15.5dB ~ +12.5dB in 0.5dB intervals)	16 (-8 dB)		✓	
14-02-09	<b>Analog Trunk Data Setup – Busy Tone Detection</b> Set the basic options for each analog trunk port.	0 = Disabled 1 = Enabled	0		✓	
20-11-31	<b>Class of Service Options (Hold/Transfer Service) – Transfer to Remote Service</b> Use this option to enable or disable an extensions ability to transfer a call to a remote conference.	0 = Disabled 1 = Enabled	COS 1 ~ 15 = 1		✓	
20-13-46	<b>Class of Service Options (Supplementary Service) – Remote Conference</b> Set Class of Service option for Remote conference.	0 = Disabled 1 = Enabled	COS 1 ~ 15 = 1		✓	
20-34-01	<b>Remote Conference Group Setting – Remote Conference – Name</b> Set name for remote conference 1 - 20.	Maximum of 12 characters.	Conferences 1 ~ 4 = Conf 1 - Conf 4 Conferences 5 ~ 20 = blank		✓	
20-34-02	<b>Remote Conference Group Setting – Remote Conference – Password</b> Set password for remote conference 1 - 20.	Maximum of 4 numbers.	Conferences 1 ~ 4 = 1111 Conferences 5 ~ 20 = blank		✓	
20-34-03	<b>Remote Conference Group Setting – Remote Conference – Remote Conference - Maximum Participants</b> Define the maximum number of participants of a Remote Conference.	0 ~ 32	Conferences 1 ~ 8 = 8 Conferences 9 ~ 20 = 0		✓	

Program Number	Program Name/Description	Input Data	Default	Level		
				1	2	3
20-34-04	<b>Remote Conference Group Setting – Remote Conference - Maximum Conference Duration</b> Set the time limit (in seconds) for each conference. ➤ <i>When this time passes, the conference is disconnected by the SV9100.</i>	0 ~ 64800 seconds	7200 seconds		✓	
20-34-05	<b>Remote Conference Group Setting – Remote Conference - Ending Conference Alert Tone Time</b> Determine how long prior to disconnecting a Remote Conference call (based on the maximum conference duration above) the SV9100 should send out a beep. ➤ <i>This is used to warn the conference participants of the pending disconnect.</i>	0 ~ 64800 seconds	300 seconds		✓	
20-34-06	<b>Remote Conference Group Setting – Remote Conference - Password Mode</b> Set remote conference to skip password or prompt for password.	0 = Normal 1 = Skip	0		✓	
20-34-07	<b>Remote Conference Group Setting – MCU Mode for Remote Conference</b> If using the Simple MCU Video feature set the MCU video mode for the remote conference. This will also require VoIP licenses (5103) ➤ <i>Setting this value for mode 1 or mode 2 determines whether Program 84-27-22 or Program 84-27-23 is used.</i>	0 = Disable 1 = Mode1 2 = Mode2	0		✓	

## Operation

### Joining a Remote Conference Call:

1. Internal Party: Lift the handset and dial the extension number of the Remote Conference pilot number (assigned in Program 11-19-01).  
 - OR -  
 External Party: Dial the telephone number for the Remote Conference pilot number (assigned in Program 11-19-01).
2. If enabled, the system prompts for a password.
3. Dial the conference group password.

4. If the correct password is entered the caller is added to the Remote Conference. If the wrong password is entered a warning tone is heard and you must hang up and dial back into the conference pilot.
  - As the conference time limit nears, the system will provide a warning tone to all participants based on Program 20-34-05. Once this timer expires, if the conference is still ongoing, the participants will be disconnected by the system.
  - If an incorrect password is entered a warning tone is heard and the caller must hang up and dial back into the conference pilot.

#### Transferring a Call into a Remote Conference Call:

1. With an active call, press the **Transfer** key.
2. Dial the **Conference Pilot number** (Program 11-19-01) then hang up. The caller enters the Remote Conference or is prompted to enter the conference password.  
  
- OR -
1. With an active call, press the **Hold** key.
2. Dial the **Conference Pilot number**, then press the **Transfer** Key. The caller enters the Remote Conference or is prompted to enter the conference password.

## Conference – Remote Conference Recording

### Description

The Remote Conference Recording feature enhances the built in conference capabilities of the SV9100 by allowing the recording of conference calls. The recording feature is configured per conference to start automatically or manually. All participants are provided an intrusion tone and a prompt stating recording has started. If a participant joins after manual recording of a conference has started they will receive the intrusion tone and a prompt stating recording has started when they join. Recordings are stored in an InMail mailbox. Due to one conference resource being used when recording, a maximum of 31 conference participants is possible for one Conference.

### Conditions

- Recordings cannot be stored in an unlicensed mailbox or in a group mailbox.
- Recordings can only be stored in a licensed InMail mailbox.
- The Remote Conference Recording feature requires version 3 system license and version 3.xx.xx or higher software.
- The recording time limit is set by multiplying Program 47-01-03 x 10 with a maximum recording limit of 65 minutes.
- Recording requires one additional conference resource to record per conference. This means the maximum number of conference participants when using the recording feature is 31.
- A conference should always be assigned for one additional participant, up to the maximum of 32, to account for the conference circuit needed for recording.
- Conference recordings will follow the notification and Email forwarding setting of the destination mailbox.
- Conference recordings cannot be stored in a UM8000 Mail or InMail Group Mailbox.
- Recorded conference can be downloaded or deleted from the system using the User Pro login for the mailbox the recordings are stored in.
- Manual recording can only be performed from a multiline telephone.
- A single 1001 – SV9100 InMail VRS Port Lic is required for the Remote Conference only if you are going to password protect the conference as VRS is used to play the “please enter your password” prompt. At default, remote conferences are set to prompt for a password in Program 20-34-06 and conferences 1-4 have passwords set. If you set the conference to 1 (Skip) in Program 20-34-06 you do not need the VRS license but still need 0047 – SV9100 Remote Conf Lic.
- If Program 20-34-06 is set to normal and no VRS license exists in the system you will get ring no answer (RNA) when calling the Remote Conference pilot.
- One Remote Conference license (0047) is required for each Remote Conference.

- A total of 96 combined callers can participate in Remote Conferences if conference resources are available and the built in modem is disabled.

### Default Settings

None

## System Availability

### Terminals

All Terminals

### Required Component(s)

- 0047 – SV9100 Remote Conf Lic
- 0413 – SV9100 Version Lic (R3)
- 1012 – SV9100 InMail VM Box Lic, mailbox used for recording storage must be licensed.
- 1001 – SV9100 InMail VRS Port Lic

## Related Features

- ↳ **Conference – Remote**
- ↳ **Simple MCU Video**

## Guide to Feature Programming

The **Level 1**, **Level 2** and **Level 3** columns indicate the programs that are assigned when programming this feature in the order they are most commonly used. These levels are used with PCPro and WebPro wizards for feature programming.

- ❑ Level 1 – these are the most commonly assigned programs for this feature.
- ❑ Level 2 – these are the next most commonly assigned programs for this feature.
- ❑ Level 3 – these programs are not often assigned and require an expert level working knowledge of the system to be properly assigned.

Program Number	Program Name/Description	Input Data	Default	Level		
				1	2	3
15-07-01	<b>Programmable Function Keys</b> Assign a function key as a recording start and stop key (Service Code #10). This must be used to record a conference if Program 20-34-08 is set to disable.	Line Key 1 ~ 48 0 ~ 99 (Normal Function Code 751 by default) *00 ~ *99 (Appearance Function Code) (Service Code 752 by default)	Refer to the Programming Manual for default values.		✓	
20-34-03	<b>Remote Conference Group Setting – Remote Conference – Remote Conference - Maximum Participants</b> Define the maximum number of participants of a Remote Conference. ➔ <i>One participant will be used when recording and should be included when setting this program.</i>	0 ~ 32	Conferences 1 ~ 4 = 8 5 ~ 20 = 0	✓		
20-34-08	<b>Remote Conference Group Setting – Conference Group Setup - Automatic Recording</b> Enable or Disable automatic recording for a Remote Conference. If disabled a line key must be used to start recording.	0 = Disable 1 = Enable	0	✓		
20-34-09	<b>Remote Conference Group Setting – Conference Group Setup - Destination Mail Box</b> Enter the mailbox number where recordings are to be stored. ➔ <i>This is the mailbox number not the extension number for a mailbox.</i>	Enter mailbox number: 1 ~ 896	No Setting	✓		
47-01-03	<b>SV9100 InMail System Options – Subscriber Message Length</b> The recording time limit is set by multiplying Program 47-01-03 x 10 with a maximum recording limit of 65 minutes. At the default (120 seconds) this will allow a 20 minute Conference Recording message to be made.	1 ~ 4095 seconds	120		✓	

## Operation

### Manual Recording a Remote Conference Call:

1. From a multiline phone press the line key assigned as the conference record key (Program 15-07-01 or SC 751: #10).
2. An intrusion tone and prompt is heard by all participants stating recording has started. All participants that join later will also hear these notifications.

3. To end the recording press the line key assigned as the conference record key.

- OR -

When all participants hang up the recording stops.

## Conference, Voice Call/Privacy Release

### Description

Voice Call Conference lets extension users in the same work area join in a trunk Conference. To initiate a Voice Call Conference, an extension user just presses the Meet-Me Conference key and tells their co-workers to join the call. The system releases the privacy on the trunk, and other users can just press the trunk line key to join the call. Line keys assigned for the trunk blink indicating that privacy has been released, and others can join the current call.

Voice Call Conference does not use the telephone system features to announce the call. The person initiating the Voice Call Conference just announces it verbally. A tone, indicating others have joined the conference, can be provided.

The GCD-CP10 provides 64 (96 when the analog modem function is not used) conference circuits, to allow two groups of internal or external parties to be conferenced together up to a limit of 32.

### Privacy Mode Toggle Option

The Privacy Mode Toggle option allows an extension user to quickly change an outside call from the non-private mode to the private mode. If the outside call is on a line key, the user just presses the line key to switch from non-private mode to private mode. For systems using the Privacy Mode Toggle option, trunks initially have the privacy released. The remainder of the call is private. If the call is on a Call Appearance (CAP) Key, the user presses their Meet-Me Conference function key instead. Unlike pressing the line key, pressing the Meet-Me Conference key toggles back and forth between private and non-private mode for the call.

### Conditions

- Call Arrival (CAR) Keys and Virtual Extensions do not support Voice Call Conference Programmable Function keys.
- Voice Call Conference requires a Meet-Me Conference function key and trunk line keys.
- This feature is not available on single line telephones.
- With Caller ID enabled, a call with Privacy Release shows the Caller ID until the call is answered. It can be viewed again by pressing the line key, though this sets the call to Private mode. To keep the call on Privacy Release, press the Help + Exit keys.

### Default Settings

Disabled



## System Availability

### Terminals

All Multiline Terminals

### Required Component(s)

None

## Related Features

- ↳ **Caller ID**
- ↳ **Conference**
- ↳ **Programmable Function Keys**

## Guide to Feature Programming

The **Level 1**, **Level 2** and **Level 3** columns indicate the programs that are assigned when programming this feature in the order they are most commonly used. These levels are used with PCPro and WebPro wizards for feature programming.

- Level 1 – these are the most commonly assigned programs for this feature.
- Level 2 – these are the next most commonly assigned programs for this feature.
- Level 3 – these programs are not often assigned and require an expert level working knowledge of the system to be properly assigned.

Program Number	Program Name/Description	Input Data	Default	Level		
				1	2	3
14-01-19	<b>Basic Trunk Data Setup – Privacy Mode Toggle Option</b> Determine if a trunk should be able to be toggled to a private/non-private line (0 = Disabled, 1 = Enabled). This option is not required for Voice Call Conference.	0 = Disable (No) 1 = Enable (Yes)	0	✓		
15-07-01	<b>Programmable Function Keys</b> Assign functions to multiline terminal line keys.	Line Key 1 ~ 48 0 ~ 99 (Normal Function Code 751 by default) *00 ~ *99 (Appearance Function Code) (Service Code 752 by default)	Refer to the Programming Manual for default values.	✓		

Program Number	Program Name/Description	Input Data	Default	Level		
				1	2	3
20-06-01	<b>Class of Service for Extensions</b> Assign a Class of Service (1 ~ 15) to extensions.	Day Night/Mode: 1 ~ 8 Class of Service of Extensions (1 ~ 15)	Extension port 101 = Class 15 All other extension port = Class 1	✓		
20-13-09	<b>Class of Service Options (Supplementary Service) – Privacy Release</b> Turn Off or On an extension user ability to initiate a Voice Call Conference.	0 = Off 1 = On	COS 1 ~ 15 = 1	✓		
20-13-17	<b>Class of Service Options (Supplementary Service) – Barge-In Tone/Display (Intrusion Tone)</b> Turn Off or On the Barge-In (Intrusion) Tone. If disabled, this also turns off the Barge-In display at the called extension.	0 = Off 1 = On	COS 1 ~ 15 = 1		✓	
31-01-04	<b>System Options for Internal/External Paging – Privacy Release Time</b> Set the interval users have to join a Voice Call Conference after it is announced. (Note that this interval is also used for Meet Me Conference.)	0 ~ 64800 seconds	90 seconds		✓	

## Operation

### To join a Voice Call Conference (if invited):

- After Conference request, press indicated line key.
  - ◇ A **Conf** indication is displayed on both telephones.
  - ◇ A trunk with privacy release or Voice Call Conference blinks.

### To exit a Voice Call Conference without affecting the other parties:

- Press **Speaker** to hang up.

### To toggle between Private and Non-Private mode:

- Press the Meet-Me Conference key (Program 15-07-01, SC 751: 32).

- OR -

Press the Trunk Line Key. (This toggles from Non-Private to Private. To go back to Non-Private, the Meet-Me Conference Key above must be pressed.)

## Contact Center

### Description

Contact Center uniformly distributes calls among agents of a programmed Contact Center Group. When a call rings into a Contact Center Group, the system automatically routes the call to the agent that has been idle the longest. Contact Center is much more sophisticated and comprehensive than Department Calling and other group services – it can accurately judge the work load at each agent and distribute calls accordingly. The system allows up to 64 Contact Center Groups and 896 Contact Center agents.

You can put any agent in any group. An agent can be in more than one group only when using AICs. This allows, for example, a Technical Service representative to answer customer service calls at lunch when many of the Customer Service representatives are unavailable.

The Contact Center Master Number is the extension number of the whole group. Calls directly ringing or transferred to the Contact Center Master number enter the group and are routed accordingly. Although the master number can be any valid extension number, you should choose a number that is out of the normal extension range.

Contact Center operation is further enhanced by:

#### Contact Center Call Queuing

When all agents in a Contact Center Group are unavailable, an incoming call queues and causes the Queue Status Display to occur on the Contact Center Group Supervisor display. The display helps the supervisor keep track of the traffic load in their group.

The Queue Status Displays shows:

- The number of calls queued for an available agent in the group.
- The trunk that has been waiting the longest, and how long it has been waiting.

For each Contact Center Group, you can set the following conditions:

- The number of trunks that can wait in queue before the Queue Status Display occurs.
- How often the time in queue portion of the display reoccurs.
- If the supervisor should hear a Queue Alarm when the time in queue portion reoccurs.
- This alarm is a single beep tone that reminds the supervisor to check the condition of the queue.
- A remote K-CCIS user can call, or transfer to a Contact Center Pilot number. However, an incoming K-CCIS call to the Contact Center Pilot does NOT provide a Link Reconnect.

## Contact Center Overflow (With Announcements)

Contact Center offers extensive overflow options for each Contact Center Group. For example, a caller ringing in when all agents are unavailable can hear an initial announcement (called the 1st Announcement). This announcement can be a general greeting like, "Thank you for calling. All of our agents are currently busy helping other customers. Please stay on the line and we will help you shortly." If the caller continues to wait, you can have them hear another announcement (called the 2nd Announcement) such as, "Your business is important to us. Your call will be automatically answered by the first available agent. Please stay on the line." If all the Contact Center Group agents still are unavailable, the call can automatically overflow to another Contact Center Group or the Voice Mail. If all agents in the overflow Contact Center Group are busy, Lookback Routing automatically ensures that the waiting call rings into the first agent in either group that becomes free.

You can assign a Contact Center Group with any combination of 1st Announcement, 2nd Announcement and overflow methods. You can have, for example, a Technical Service group that plays only the 2nd Announcement to callers and then immediately overflows to Voice Mail. At the same time, you can have a Customer Service group that plays both announcements and does not overflow.

You can assign a Contact Center Group to play the Queue Depth only when using the VRS for message. The Queue Depth can be played after the 1st Announcement only, 2nd Announcement only, or after both Announcements.

## Dial Out of Delay Announcements

When listening to a VRS delay announcement, the caller can press a 1-key option to transfer them to another extension, Voice Mail, Ring Group, another Contact Center Group, or to a Speed Dial bin. The caller can press the digit during the message only or for X seconds after the message. This per Queue option effects both the first and second delay announcement if set.

## VRS Delay Announcements Using InMail

InMail can provide Contact Center Delay Announcements. Any of the 32 (1~32) InMail Routing mailboxes (Program 47-07-01) can be set to Announcement mailboxes and can be used as the message source for the 1st and 2nd Announcement Messages. This option is applicable only to Contact Center Overflow modes that are assigned Contact Center delayed messages and Program 41-08-03 must be set to 2.

## Agent Log In and Log Out Services

A Contact Center Agent can log in and log out of their Contact Center Group. While logged in, the agent is available to receive Contact Center Group calls. When logged out, the agent is excluded from the group calls. The programmable keys and Alphanumeric Display on an agent telephone show at a glance when they are logged in or logged out.

**Agent Identity Code (AIC)**

An Agent Identity Code (AIC) allows Contact Center agents to log in any extension without setting Program 41-02-01. Using AIC, Contact Center agents can also log in to multiple Contact Center groups at the same time (up to 64 Contact Center Groups). The system also allows all extensions (up to the system maximum) to log in using the same AIC code. AIC and Contact Center groups for each work period (mode pattern number) can be set in Program 41-18-01 as shown in the following example.

Table #	AIC	Operation Group	Mode Pattern Number							
			1	2	3	4	5	6	7	8
1	789	1	1	1	-	-	-	-	-	-
2	789	1	2	1	-	-	-	-	-	-
3	789	1	16	1	-	-	-	-	-	-
4	567	10	10	10	10	10	10	10	10	10
5	678	2	2	2	2	2	2	2	2	2
6	678	2	3	3	3	3	3	3	3	3
7	678	2	5	5	5	5	5	5	5	5

**EXAMPLE:**

With this example, Contact Center works as follows:

Example 1: Log In with AIC 789

- During Mode Pattern 1, Contact Center agents belong to Contact Center groups 1, 2, and 16 at the same time.
- During Mode Pattern 2, Contact Center agents belong to only Contact Center group 1.
- During Mode Pattern 3~8, Contact Center agents do not belong to any Contact Center group and the Contact Center extensions work as normal extensions.

Example 2: Log In with AIC 567

- During Mode Patterns 1~8, Contact Center agents belong to only Contact Center group 10.

Example 3: Log In with AIC 678

- During Mode Patterns 1~8, Contact Center agents belong to Contact Center groups 2, 3 and 5 at the same time.

## Multiple Agent Log In

Contact Center agents can log in any extension with multiple AICs (up to three). Using the example setup above, Contact Center works as follows:

### EXAMPLE:

#### Example 1: Log In with AIC 789 and 567

- During Mode Pattern 1, Contact Center agents belong to Contact Center groups 1, 2, 10 and 16 at the same time.
- During Mode Pattern 2, Contact Center agents belong to Contact Center groups 1 and 10.
- During Mode Pattern 3~8, Contact Center agents belong to only Contact Center group 10.

#### Example 2: Log In with AIC 789, 567 and 678

- During Mode Pattern 1, Contact Center agents belong to Contact Center groups 1, 2, 3, 5, 10 and 16 at the same time.
- During Mode Pattern 2, Contact Center agents belong to Contact Center groups 1, 2, 3, 5 and 10.
- During Mode Pattern 3~8, Contact Center agents belong to only Contact Center groups 2, 3, 5 and 10.

Some conditions with Multiple Agent Log In:

- Contact Center agents cannot log in to the system supervisor or group supervisor extension.
- To log in with AIC, the extension should be set to AIC Log In mode in Program 41-17-01.
- If the extension is set to AIC log in mode in Program 41-17-01, the system ignores the setting of Program 41-02-01 for the extension.
- Multiple extensions (up to the maximum capacity of the extension) can log-in with one AIC. For example, even if Contact Center agent A logs in extension 350 with AIC 789, Contact Center agent B can also log in to extension 351 with the same AIC 789 at the same time.
- A supervisor cannot log out an agent logged in by an AIC code.
- When logging into multiple queues using either a single AIC code or multiple AIC codes, the first default queue is used for timers and alarm displays.

## Emergency Call

If a Contact Center Agent needs assistance with a caller, they can place an Emergency Call to their Contact Center Group Supervisor. Once the supervisor answers the Emergency Call, they automatically monitor both the Contact Center Agent and the caller. If the agent needs assistance, the supervisor can join in the conversation. Emergency Call can be a big help to inexperienced Contact Center Agents that need technical advice or assistance with a difficult caller. The supervisor can easily listen to the conversation and then “jump in” if the situation gets out of hand.

## Enhanced DSS Operation

A programmed extension user can use their DSS Console to monitor the status of the Contact Center Agents in a group. The DSS Console is an essential tool for supervisors. The console key flash rates tell the supervisor at a glance which of the group agents is:

- Logged onto the group (i.e., in service).
- Logged out of the group (i.e., out of service).
- Busy on a call.
- Placing an Emergency Call to the supervisor.
- Not available or installed.

The Contact Center Supervisor can use their console also for placing and transferring calls – just like any other extension user.

## Flexible Time Schedules

A Contact Center Work Schedule lets you divide a day into segments (called Work Periods) for scheduling the activity in your Contact Center Groups. You can set up four distinct Work Schedules, with up to eight Work Periods in each Work Schedule. Each day of the week has one Work Schedule, but different days can share the same schedule. For example, your Monday through Friday Work Schedule could consist of only two Work Periods. Work Period 1 could be from 8:00 AM to 5:00 PM – when your business is open. Work Period 2 could be from 5:00 PM to 8:00 AM – which covers those times when your business is closed.

## Headset Operation (With Automatic Answer)

A Contact Center Agent or Contact Center Group Supervisor can use a customer-provided headset in place of the handset. The headset conveniently frees up the user's hands for other work and provides privacy while on the call. In addition, a Contact Center Agent with a headset can have Automatic Answer. This allows an agent busy on a call to automatically connect to the next waiting call when they hang up.

## Incoming Call Routing

Incoming trunk calls can automatically route to specific Contact Center Groups. These types of calls ring directly into the Contact Center Group without being transferred by a co-worker or the Automated Attendant.

## Rest Mode

Rest Mode temporarily logs-out a Contact Center agent's telephone. There are two types of Rest Mode:

### **Manual Rest Mode:**

A Contact Center Agent can enable Manual Rest Mode anytime they want to temporarily leave the Contact Center Group. They might want to do this if they go to a meeting or get called away from their work area. While in Rest Mode, calls to the Contact Center Group do not ring the agent's telephone.

**Automatic Rest Mode:**

When a Contact Center Group has Automatic Rest Mode, the system automatically puts an agent's telephone in Rest Mode if it is not answered. This ensures callers do not have to wait while Contact Center rings an extension that is not answered. For multiline terminals, the system enables Automatic Rest Mode for all telephones with Rest Mode keys. For single line telephones, you must set an option in programming to enable Automatic Rest Mode. If an agent's telephone is placed in Rest Mode because a call is not answered, the agent needs to manually cancel Rest Mode to log back into the Contact Center group.

With a Rest Mode key programmed on a Contact Center agent's telephone, when the agent is in rest mode, the key is lit. If the Rest Mode key is pressed while an agent is on a call, the key flashes to indicate a pre-Rest Mode status. When the current call is finished, the agent's telephone is in rest mode. The agent can place intercom calls or receive direct incoming calls while in Rest Mode. The ability to receive incoming intercom calls is defined in system programming for each Contact Center group.:



NOTE

*A Contact Center System Supervisor cannot be placed in Rest Mode.*



NOTE

*When logging in with AIC mode, Program 41-18-02 must be set for 41-14-08 to work.*

## Supervisor, Contact Center Group

You can designate an extension in a Contact Center Group to be the group supervisor.



NOTE

*A Contact Center Group can only have one supervisor.*

Once assigned as a Contact Center Group Supervisor, the user can:

- Take the entire Contact Center Group out of service (outside callers will hear ringback or the ACI recording).
- Check the log out status of each agent after the group has been taken down.
- Restore the Contact Center Group to service.

During programming, you can choose one of three modes of operation for each Contact Center Group supervisor:

- The Supervisor's extension cannot receive calls to the Contact Center Group (mode 0).
- The Supervisor's extension can only receive Contact Center Group calls during overflow conditions (mode 1).
- The Supervisors extension receives calls just like any other Contact Center Group agent (mode 2).

In addition, any extension can be a supervisor for only one Contact Center Group. There is a maximum of 64 available Contact Center Groups.



## Supervisor, Contact Center System

You can designate an extension as a Contact Center System Supervisor.



*The system can have only one Contact Center System Supervisor.*

NOTE

Once assigned as a Contact Center System Supervisor, the user can:

- Take all system Contact Center Groups out of service simultaneously (outside callers will hear ringback or the ACI recording).
- Check the log out status of each agent after the groups are taken down.
- Restore all Contact Center Groups to service simultaneously.
- Log an agent into or out of a Contact Center Group.
- Reassign an agent to a different Contact Center Group.

### Work Time

Work Time temporarily busies-out a Contact Center agent's telephone so they can work at their desk uninterrupted. This gives the agent time to fill out important logs and records as soon as they are finished with their call. There are two types of Work Time:

**Manual Work Time:**

A Contact Center Agent can enable Manual Work Time anytime they need to work at their desk undisturbed. You might prefer this Work Time mode if an agent only occasionally has to fill out follow-up paper work after they complete their call. When the agent is through catching up with their work, they manually return themselves to the Contact Center Group.

**Automatic Work Time:**

The system implements Automatic Work Time for the agent as soon as they hang up their current call. This is helpful in applications (such as Tech Service groups) where follow-up paperwork is a requirement for every call. When the agent is done with their work, they manually return themselves to the Contact Center Group.

### Hotline Key Shows Agent Status

An extension Hotline key provides the normal Busy Lamp Field (BLF) for co-workers and a unique BLF for Contact Center Agents. Like the supervisor's DSS Console BLF, the unique BLF shows when the covered agent is in service, out of service or busy on a call. This enhanced BLF gives a department manager, for example, Contact Center Group monitoring abilities without having to become a supervisor with a DSS Console.

Hotline gives a multiline terminal user one-button calling and Transfer to another extension (the Hotline partner). Hotline helps co-workers that work closely together. The Hotline partners can call or Transfer calls to each other just by pressing a single key. Enhanced for Contact Center applications, Hotline provides a unique Busy Lamp Field for Contact Center agents as well as a BLF for co-workers that are not Contact Center agents. The charts below show both sets of BLF indications.

BLF For Contact Center Agents	
When the key is . . .	The Contact Center Agent is . . .
Off	Idle and is not a Contact Center Agent
On	Busy
Double Wink Off	Making an Emergency Call
Wink Off	Logged off or not installed
Double Wink On	Logged on

BLF For Co-Workers That Are Not Contact Center Agents	
When the key is . . .	Your co-worker is . . .
Off	Idle
On	Busy or ringing
Fast	Flash In Do Not Disturb – All calls (option 3) or Intercom calls (option 2)

**Enhanced Supervisor Options:**

A Contact Center supervisor can individually assign extensions to Contact Center Groups, and set an agent’s status once assigned. This provides the supervisor with tremendous flexibility to reassign agents as work loads vary.

**Queue Status Display with Scrolling:**

When all agents in a Contact Center Group are unavailable, an incoming call queues and causes the Queue Status Display to occur on the Contact Center Group Supervisor and/or agent’s display (based on the Class of Service). The display helps the supervisor keep track of the traffic load in their group. Any display multiline terminal can have a Queue Status Display Check programmable function key. The multiline terminal user can press this key anytime while idle, and using the VOL (▲) and VOL (▼), scroll through the Queue Status Displays of all the Contact Center Groups. The Queue Status Displays shows (see the Queue Status Display illustration below):

- The number of calls queued.
- The trunk that has been waiting the longest, and how long it has been waiting.

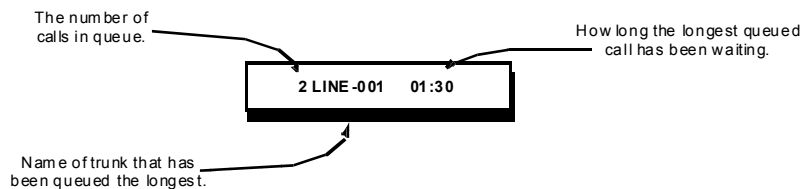

For each Contact Center Group, you can set the following conditions:

- The number of trunks that can wait in queue before the Queue Status Display occurs.
- How often the time in queue portion of the display reoccurs (see the Queue Status display Timing illustration below).
- Queue Status Display holding time.
- Queue Status Alarm enable/disable.
- Queue Status Alarm sending time.

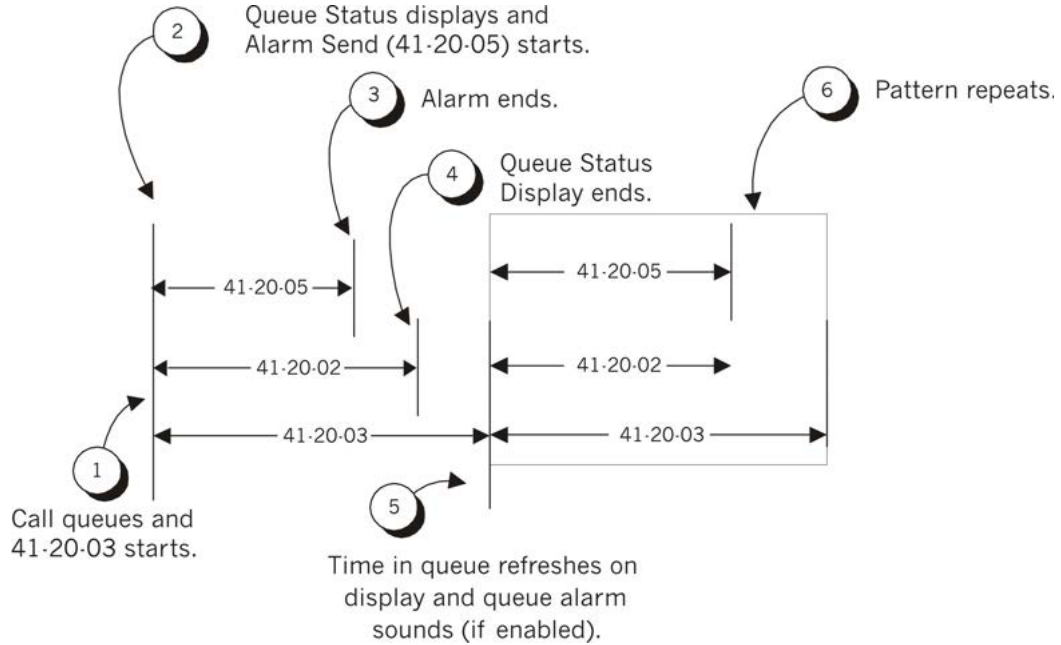

**When Logged Out of Contact Center Group:**

When Contact Center agents are logged out and a call is placed into the Contact Center queue, the telephones of the logged out agents display the Queue Status and they hear the alarm according to the settings defined in system programming. Pressing the Queue Status Display Programmable Function key returns the telephone to idle until the time in Program 41-20-03 expires again.

- ◇ Do not use both Program 41-15-01~02 and Program 41-20-01~05 to set the Contact Center queue alarm. Select either one or the other for the system to follow.

Feature	Available in Program 41-15-01~02	Available in Program 41-20-01~05
Queue Status Display	---	Yes
Queue Status Display Time	---	Yes
Alarm	Yes	Yes
Alarm Send Time	Program 41-15-02 determines the length/interval of the alarm.	Yes
Interval Time of Queue Status Display		Yes

Feature	Available in Program 41-15-01~02	Available in Program 41-20-01~05
Class of Service	---	Yes
Timing of alarm and display queue status	Alarm triggered after the number of calls in Program 41-15-01 is exceeded.	Alarm triggered after the number of calls in Program 41-20-01 is exceeded. Then follows Program 41-20-03 timing for displaying status.

- ◇ *If a telephone is not idle, it cannot use the Queue Status Display Programmable Function key.*
- ◇ *The Queue Status Display is not shown and the Queue Alarm is not heard by Contact Center agents in Off-Duty mode.*
- ◇ *To scroll through the Contact Center groups queue status, the Queue Status Display Programmable Function key must be used. You cannot scroll when the Queue Status Display is displayed due to an alarm.*
- ◇ *If the Queue Status display and alarm are active and the queued called is answered/disconnected, the display and alarm continue until the times in Program 41-20-02 and Program 41-20-05 expire.*
- ◇ *When an overflowed call is in queue, the call is included in its original Contact Center group queue and not in the group queue to which it overflowed.*
- ◇ *The Queue Status is not displayed on a supervisor's telephone based on the settings in Programs 41-20-xx. The supervisor must use the Queue Status Display Programmable Function key to view the queue.*

### Programmable Wrap-up Timer

When an agent finishes their call, the system automatically starts a wrap-up timer and blocks any Contact Center calls to the agent. This gives them time to complete important logs and records before a new call comes in. When the time expires, the system returns the agent to the Contact Center Group to handle new callers.

### NEC Contact Center

The NEC Contact Center is a series of Windows®-based software programs designed to enhance the Contact Center features of the UNIVERGE SV9100 Telephone System. The software displays both real-time data and historical reports. The NEC Contact Center is supported on Windows Server 2003, Windows Server 2008, Windows 7 Professional and Ultimate 32- and 64-bit, Windows 8 Professional and Enterprise 32- and 64-bit, Windows 8.1 Professional and Enterprise 32- and 64-bit and Windows Embedded Standard (in Server on NEC InServer blade).



*Refer to the NEC Contact Center Supervisor Manual for more information.*

REFERENCE

### Contact Center Group as Overflow Destination

The system can transfer an overflow call to a specific Contact Center Group, off-site via a speed dial bin, Ring Group or to voice mail using Program 41-09-01. When Program 41-08-02: Contact Center Overflow Destination has the Contact Center Overflow Destination set to 65, the system overflows the call to the Group programmed in Program 41-09-01. (The system does not allow you to program a Contact Center group with that Contact Center group as the overflow.) If, while the call is ringing, the extension where the call was transferred becomes available, both the extension and the overflow Contact Center group ring.

### Contact Center Skill Based Routing

The system can receive and distribute Contact Center calls based on the Agent's skill level. There are seven priority levels that the Agents can be set to for each Contact Center Queue. Each queue can have a different priority level. This works for both AIC and Normal Agents. The Skill levels are based on the Login ID that the Agents use.



*Refer to the NEC Contact Center Installation Manual for setup instructions.*

### Contact Center Caller ID Based Routing

The SV9100 can allocate a Contact Center incoming call to an agent by using Caller ID registered in a buffer. This is done when a Contact Center Agent presses the **[Contact Center Caller ID Marking Setup]** Function Key and marks information of the caller when he thinks this caller would call again. By the Contact Center Agent pressing the Function Key that marks the Caller ID to the system, the next time the same Caller ID calls back into Contact Center, the Caller ID based routing tries to route the call to the agent that marked the call. It provides smoother call center operation.

### Enhancements

- With SV9100 Version 3000 or higher, Contact Center can light or flash a function key for Queue Status Display in addition to the LCD display. The ACD Queue Alarm Function key is supported on the DT300/400, DT700/800, Softphone and Bluetooth cordless handset.
- With SV9100 Version 3000 or higher, the Contact Center can restrict Agent login based on the ID Code list.
- With SV9100 Version 4000 or higher, Overflow Timer starts immediately when Contact Center call is received at Contact Center Group.
- With SV9100 Version 4000 or higher, Overflow Timer is cleared when Contact Center agent answers the call or caller hangs up.
- With SV9100 Version 4000 or higher, when Overflow Timer is timed out, Contact Center call overflows as per program 41-08.
- With SV9100 Version 4000 or higher, Contact Center call is queued to Contact center wait queue in the order in which it enters the Contact Center Group.

- With SV9100 Version 4000 or higher, when Contact Center call enters the Contact Center wait queue; if the call is not answered after ringing at the Contact Center agent, it is queued in the same order in which it comes to the Contact Center Group.
- With SV9100 Version 4000 or higher, if Overflow timer is timed out when Contact Center call is ringing at an agent, Contact Center call does not overflow. But if Contact Center Agent does not answer the call and call goes to the Contact Center wait queue, Contact Center call overflows.

## Conditions

### System:

- The Contact Center Wait queue exists for every Contact Center group.
- The Call Duration Timer (Program 20-13-36) is not displayed for inbound Contact Center calls.
- InMail can play Contact Center Delay Announcements.
- If all agents are logged out of a Contact Center Queue, a transferred call to the Contact Center Pilot number recalls immediately back to the transferring party.
- If all agents are logged out of a Contact Center Queue, a trunk call directly to the Queue is placed in queue.
- If all agents are logged out of a Contact Center Queue, a transferred call to the Contact Center Pilot number recalls immediately back to the transferring party if no Overflow Destination is setup.
- If all agents are logged out of a Contact Center Queue, a transferred call to the Contact Center Pilot number will be placed in queue if an Overflow Destination is setup.
- If defined in Program 22-11-03, DID calls in queue display the trunk name with the Queue Status feature.
- When Program 12-07-01 is customized, an agent's display does not indicate the WAIT Contact Center LOGIN status, however an agent may still log in.
- Conversation Recording is programmed system-wide – it is not Contact Center feature-specific.
- Up to 16 channels (speech paths) are available when using the DSP with VRS installed on the GCD-CP10 for messages.
- When the PGD(2)-U10 ADP is providing the 1st Delay Announcements, it continues to play until the call is answered, abandoned, or the time in 41-10-04 expires and starts to play the 2nd Delay Announcement. The 2nd Delay Announcement continues to play until the call is answered, abandoned, or the time in 41-10-05 expires and drops the call. This message does not start from the beginning because it is on a constant loop.
- The Dial Out of Queue feature is not supported during InMail Delay Announcements.
- Wireless DECT (SIP) is not supported with Contact Center.

- When all InMail talk paths (ports) are simultaneously being accessed by InMail Mailbox subscribers or Voice Mail Delay Announcements, or combination of the two, the next incoming call to the InMail will Ring No Answer until an available talk path becomes idle (First Come – First Served).
- When Voice Mail Delay Announcements are being played, InMail talk paths (ports) are used.
- InMail cannot be used for Contact Center Night Announcement.
- Program 41-08-03: Contact Center Overflow Options – Delay Announcement Source Type.
- The ACI port used for the Contact Center Delay Announcements is programmed like Music on Hold (MOH) ACI ports. Refer to the MOH [Music on Hold on page 2-1192](#).
- Contact Center can only support one Music on Hold source.
- When an agent is in a Ring Group and logged in, it will not ring when a call comes to the Ring Group. It will ring when logged out.
- If a phone has never been brought up and is assigned as an agent, the system will have to be reset before the phone is able to login.
- The End of Work Key (\*14) from a System Supervisor will only put Contact Center Groups that have Normal Agents logged in into the End of Work. Groups that only have AIC agents will not be put in the End of Work.
- If the Help key is pressed when an Agent is logged in, calls in Queue are not received until the Agent exits the Help menu.
- When Contact Center delay announcements are used, and a call is delivered to an available Contact Center agent, the agent MLT display may show one or two exclamation points while the call is ringing.
  - One exclamation point – indicates the incoming caller has queued long enough to hear the first delay announcement.
  - Two exclamation points – the caller has been in queue and heard both the first and second delay announcements.
- If a Contact Center Agent places a Contact Center call on hold to answer an incoming non-Contact Center call (Trunk or Station), the system will offer another Contact Center call to the Agent when the non-Contact Center call terminates. To prevent the second Contact Center call from being sent, it is recommended the Agent go into the break or wrap mode before finishing the non-Contact Center call.
- On Contact Center extensions, **Hold Recall to Operator is not supported.**
- When a caller dials out of one queue into another queue, the overflow timer of the original queue is followed.
- In order for Queue Depth Announcement to function an idle VRS Port must be available. Therefore, a minimum of two VRS Ports are required, one for the Delayed Announcement and one for the Queue Depth Announcement.



### NEC Contact Center:

- InServer SVR2 Blade – The SVR2 is an in-skin blade for the SV9100 designed to be an application server for several of the external applications available for the SV9100 product line. Initially, the SVR2 will come pre-installed with Windows 7 Embedded Standard OS and support the setup and deployment of the NEC UC Suite and NEC Contact Center.
- The UNIVERGE SV9100 system does not buffer the Contact Center Statistics when the PC running the Contact Center Server application is not connected.
- The programming of the Agents and Queues in the UNIVERGE SV9100 system are not transferred to the PC running the Contact Center Server applications. The NEC Contact Center Server applications are programmed separately.
- A supervisor assigned to not receive calls or take calls after the overflow time is reached shows as idle in Contact Center when they are logged in and idle even when calls are queued up and not reaching the overflow timer.
- Call Detail by Queue Report shows the Caller ID (if available) for each call.
- A new report (Abandoned Call Detail by Queue) has been built and will display the Caller ID for each abandoned call.
- The maximum number of Contact Center Monitoring programs that can run simultaneously is 16.

### ACD Queue Alarm Function Key

- If the number of calls in queue is more than Program 41-20-01, the ACD Queue Alarm Display Key lights or flashes based on settings in Program 41-20-06.
- If Program 41-20-06 is less than Program 41-20-01, the ACD queue alarm display key will flash, not light solid.
- The state of the ACD Queue Alarm Display key is not affected by the update interval in Program 41-20-03.
- The ACD Queue Alarm Display key will not flash or light if Program 41-06-01 is set to 0.
- The notification by the function key is set on all terminals the button is programmed on regardless of the state of the terminal.
- The key will lamp when in ACD Log Out, ACD Work Wrap up time and ACD Off Duty Mode.

### Default Settings



REFERENCE

*Refer to the NEC Contact Center Supervisor Manual for more details.*



## System Availability

### Terminals

All Terminals

### Required Component(s)

- 2002 – SV9100 Contact Center Agent Lic
- 0411 – SV9100 Version Lic

### Required Software

None

## Related Features

- ↳ **Direct Inward Dialing (DID)**
- ↳ **Music on Hold**
- ↳ **Night Service**
- ↳ **InMail**
- ↳ **Voice Mail Integration (Analog)**

## Guide to Feature Programming

The **Level 1**, **Level 2** and **Level 3** columns indicate the programs that are assigned when programming this feature in the order they are most commonly used. These levels are used with PCPro and WebPro wizards for feature programming.

- Level 1 – these are the most commonly assigned programs for this feature.
- Level 2 – these are the next most commonly assigned programs for this feature.
- Level 3 – these programs are not often assigned and require an expert level working knowledge of the system to be properly assigned.



*Refer to the NEC Contact Center Supervisor Manual for complete programming information.*

Program Number	Program Name/Description	Input Data	Default	Level		
				1	2	3
11-13-01	<b>Service Code Setup (for Contact Center) – Contact Center Login/Log Out (for KTS)</b> Assign for multiline terminals and single line telephones.	MLT, SLT Maximum of eight digits 0 ~ 9, *, #	* 5		✓	
11-13-02	<b>Service Code Setup (for Contact Center) – Contact Center Log Out (for SLT)</b> Assign for single line telephones.	SLT Maximum of eight digits 0 ~ 9, *, #	655		✓	
11-13-03	<b>Service Code Setup (for Contact Center) – Set Contact Center Wrap-Up Time (for SLT)</b> Assign for single line telephones.	SLT Maximum of eight digits 0 ~ 9, *, #	656		✓	
11-13-04	<b>Service Code Setup (for Contact Center) – Cancel Contact Center Wrap-Up Time (for SLT)</b> Assign for single line telephones.	SLT Maximum of eight digits 0 ~ 9, *, #	657		✓	
11-13-05	<b>Service Code Setup (for Contact Center) – Set Contact Center Off Duty (for SLT)</b> Assign for single line telephones.	SLT Maximum of eight digits 0 ~ 9, *, #	658		✓	
11-13-06	<b>Service Code Setup (for Contact Center) – Cancel Contact Center Off Duty (for SLT)</b> Assign for single line telephones.	SLT Maximum of eight digits 0 ~ 9, *, #	659		✓	
11-13-08	<b>Service Code Setup (for Contact Center) – Agent ID Code Login</b> Assign to allow an AIC Agent to log into a group.	MLT, SLT Maximum of eight digits 0 ~ 9, *, #	No Setting		✓	
11-13-09	<b>Service Code Setup (for Contact Center) – Agent ID Code Logout</b> Assign to allow an AIC Agent to log out of a group.	MLT, SLT Maximum of eight digits 0 ~ 9, *, #	No Setting		✓	
11-13-10	<b>Service Code Setup (for Contact Center) – Contact Center Agent Login by Supervisor</b> Assign to allow a Contact Center Supervisor to log into a group.	MLT Maximum of eight digits 0 ~ 9, *, #	667		✓	
11-13-11	<b>Service Code Setup (for Contact Center) – Contact Center Agent Logout by Supervisor</b> Assign to allow a Contact Center Supervisor to log out of a group.	MLT Maximum of eight digits 0 ~ 9, *, #	668		✓	
11-13-12	<b>Service Code Setup (for Contact Center) – Change Agent Contact Center Group by Supervisor</b> When using service code 669 to change an agent Contact Center group, the supervisor must enter a 2-digit number for the group. For example, to change to Contact Center group 4, the entry would be 669 04.	MLT Maximum of eight digits 0 ~ 9, *, #	669		✓	

Program Number	Program Name/Description	Input Data	Default	Level		
				1	2	3
11-13-13	<b>Service Code Setup (for Contact Center) – Contact Center Agent Changing Own Contact Center Group</b> When this service code is used, a Contact Center Agent can reassign themselves to another Contact Center Group.	MLT Maximum of eight digits 0 ~ 9, *, #	670		✓	
11-17-01	<b>Contact Center Group Pilot Number</b> Assign the Contact Center Master Number for each Contact Center Group.	Contact Center Group Number: 01 ~ 64 Contact Center Group Pilot Number: Maximum of eight digits	No Setting		✓	
15-07-01	<b>Programmable Function Keys</b> Assign functions to multiline terminal line keys.	Line Key 1 ~ 48 0 ~ 99 (Normal Function Code 751 by default) *00 ~ *99 (Appearance Function Code) (Service Code 752 by default)	Refer to the Programming Manual for default values.	✓		
15-08-01	<b>Incoming Virtual Extension Ring Tone Setup</b> When an extension or a virtual extension is assigned to the function key on the key telephone, select the ring tone when receiving a call on that key. For Contact Center CAR keys, only tone pattern 1 (entry 0) can be used. The remaining patterns are not checked with this feature.	0 = Tone Pattern 1 1 = Tone Pattern 2 2 = Tone Pattern 3 3 = Tone Pattern 4 4 = Incoming Ring Tone Extension 5 = Tone Pattern 5 6 = Tone Pattern 6 7 = Tone Pattern 7 8 = Tone Pattern 8	0 = Tone Pattern 1		✓	
15-09-01	<b>Virtual Extension Ring Assignment</b> Assign the ringing options for an extension Virtual Extension Key or Virtual Extension Group Answer Key, which is defined in Program 15-07. Make an assignment for each Night Service Mode. There are 512 Virtual Extension Ports.	Day Night/Mode: 1 ~ 8 Ringing: 0 = No Ringing 1 = Ring	0		✓	
15-11-01	<b>Virtual Extension Delayed Ring Assignment</b> Assign the delayed ringing options for an extension Virtual Extension or Virtual Extension Group Answer keys (defined in Program 15-09). You make an assignment for each Night Service Mode. There are 512 Virtual Extension Ports.	Day Night/Mode: 1 ~ 8 Ringing: 0 = Immediate Ring 1 = Delayed Ring	0		✓	
20-04-03	<b>System Options for Virtual Extensions – CAR/SIE/Virtual Extension Delay Interval</b> CAR Keys/SIE Keys/Virtual Extensions set for Delayed Ringing (see Program 15-11) ring the extension after this interval.	0 ~ 64800 seconds	10		✓	

Program Number	Program Name/Description	Input Data	Default	Level		
				1	2	3
20-06-01	<b>Class of Service for Extensions</b> Assign a Class of Service (COS) to an extension. There are 15 Classes of Service that can be assigned. Assign eight entries, one for each Night Service Mode.	Day Night/Mode: 1 ~ 8 Class of Service of Extensions (1 ~ 15)	Extension port 101 = Class 15 All other extension port = Class 1		✓	
20-13-06	<b>Class of Service Options (Supplementary Service) – Automatic Off-Hook Signaling (Automatic Override)</b> Allow a busy extension user to Manually (0) or Automatically (1) receive off-hook signals. ➡ <i>This setting is to receive incoming call signaling information during call queuing.</i>	0 = Off 1 = On	COS 1 ~ 15 = 1		✓	
20-13-33	<b>Class of Service Options (Supplementary Service) – Contact Center Supervisor's Position Enhancement</b> Set this option to On for the operator to use service codes in Program 11-13-10 ~ 11-13-13.	0 = Off 1 = On	COS 1 ~ 15 = 0		✓	
20-13-39	<b>Class of Service Options (Supplementary Service) – Contact Center Queue Status Display</b> Turn Off or On the Contact Center Queue Status Display for an extension Class of Service. Any extension, which has this option enabled, also hears the queue alarm.	0 = Off 1 = On	COS 1 ~ 15 = 0		✓	
22-01-11	<b>System Options for Incoming Calls – VRS Waiting Message Interval Time</b> Setup the sending duration time of the Auto – Attendant & Queuing. The message is repeatedly sent out during the specified time.	0 ~ 64800 seconds	20	✓		
30-01-01	<b>DSS Console Operating Mode</b> Set the mode of the system DSS consoles. The entry for this option applies to all the system DSS consoles.	0 = Business Mode 1 = Hotel Mode 2 = Contact Center Monitor Mode 3 = Business/Contact Center Mode	0		✓	
30-05-04	<b>DSS Console Lamp Table – Contact Center Agent Busy</b> Define the LED patterns for functions on the DSS consoles. The entry for this option applies to all the system DSS consoles.	0 ~ 7 (Lamp Pattern Data)	7 (On)		✓	
30-05-05	<b>DSS Console Lamp Table – Out of Schedule (Contact Center DSS)</b> Define the LED patterns for out of schedule (Contact Center/DSS) functions on the DSS consoles.	0 ~ 7 (Lamp Pattern Data)	0 (Off)		✓	
30-05-06	<b>DSS Console Lamp Table – Contact Center Agent Log Out (Contact Center DSS)</b> Define the LED patterns for functions on the DSS consoles.	0 ~ 7 (Lamp Pattern Data)	5 (IL)		✓	

Program Number	Program Name/Description	Input Data	Default	Level		
				1	2	3
30-05-07	<b>DSS Console Lamp Table – Contact Center Agent Log In (Contact Center DSS)</b> Define the LED patterns for functions on the DSS consoles.	0 ~ 7 (Lamp Pattern Data)	4 (IR)		✓	
30-05-08	<b>DSS Console Lamp Table – Contact Center Agent Emergency (Contact Center DSS)</b> Define the LED patterns for functions on the DSS consoles.	0 ~ 7 (Lamp Pattern Data)	6 (IW)		✓	
40-10-01	<b>Voice Announcement Service Option – VRS Fixed Message</b> Enable (1) or Disable (0) the system ability to play the fixed VRS messages (such as You have a message).	0 = Not Used 1 = Used	0		✓	
41-01-01	<b>System Options for Contact Center – System Supervisory Extension</b> Define the Contact Center Supervisor for the entire system.	Maximum of eight digits 0 ~ 9, *, #	No Setting		✓	
41-01-02	<b>System Options for Contact Center – Login ID Code Digit</b> Define the number of digits for agent login ID code.	0 ~ 20 (0 = No Login ID)	0		✓	
41-01-03	<b>System Options for Contact Center – Contact Center Connection Ports</b> Define what port is used for Contact Center connection. Currently only LAN is supported.	0 = None 3 = LAN (CPU)	0	✓		
41-01-04	<b>System Options for Contact Center – Contact Center-Command Notification when a BT Message is returned</b> Contact Center-Command Notification when a BT message is returned.	0 = Notifies 1 = No notification	0		✓	
41-01-06	<b>System Options for Contact Center – Login ID Restriction</b> Determine whether an ACD Agent Login Code must match Code set in Program 41-21-01.	0 = Disable 1 = Enable	0		✓	
41-02-01	<b>Contact Center Group and Agent Assignments</b> For each Contact Center extension number, assign a Contact Center Group (1 ~ 64). A Contact Center Group number is assigned to each Work Period number (1 ~ 8).	Contact Center Work Period Mode Number: 1 ~ 8 Contact Center Group Number: 0 ~ 2 (0 = No Setting)	0		✓	
41-03-01	<b>Incoming Ring Group Assignment for Contact Center Group – Contact Center Group Number</b> For each incoming trunk group set up in Program 22-05, designate which Contact Center Group (1 ~ 64) the trunks should ring for each of the eight Work Periods.	Contact Center Group Number: 0 ~ 64 (0 = No Setting)	0	✓		

Program Number	Program Name/Description	Input Data	Default	Level		
				1	2	3
41-03-02	<b>Incoming Ring Group Assignment for Contact Center Group – Night Announcement Service</b> Designate for each incoming trunk, whether or not Night Announcement Service is assigned.	0 = No 1 = Yes	0		✓	
41-03-03	<b>Incoming Ring Group Assignment for Contact Center Group – Priority Data</b> Determine whether an incoming call to a trunk ring group should follow a priority assignment.	0, 1 ~ 7 0 = No Priority 1 = Highest Priority 7 = Lowest Priority	0		✓	
41-04-01	<b>Contact Center Group Supervisor – Group Supervisor Extension</b> Assign the group supervisor extension.	Extension Number = Maximum of eight digits	No Setting		✓	
41-04-02	<b>Contact Center Group Supervisor – Operation Type</b> Assign the supervisor operating type.	0 = Do Not receive any Contact Center incoming calls (No) 1 = Receive Contact Center incoming calls in case of overflow (Busy) 2 = Receive Contact Center incoming calls all the time (Yes)	0		✓	
41-05-01	<b>Contact Center Agent Work Schedules</b> Set up the Work Schedules for Agents and Groups. For each Contact Center Work Schedule (1 ~ 4), designate the start and stop times for each of the eight Work Periods. After the schedules are set up in this program, assign them to days of the week in Program 41-07. (This is the same program used by the Trunk Work Schedules.) After the schedules are set up in this program, assign them to days of the week in Program 41-07.	Work Period Mode Number = 1 ~ 8 Start Time = 0000 ~ 2359 End Time = 0000 ~ 2359	(Start) 0000 (End) 0000	✓		
41-06-01	<b>Trunk Work Schedules</b> Set up the Work Schedules for trunks. For each Work Schedule (1 ~ 4), designate the start and stop times for each of the eight Work Periods. After the schedules are set up, assign them to days of the week in Program 41-07.	Work Period Mode Number = 1 ~ 8 Start Time = 0000 ~ 2359 End Time = 0000 ~ 2359	(Start) 0000 (End) 0000	✓		

Program Number	Program Name/Description	Input Data	Default	Level		
				1	2	3
41-07-01	<p><b>Contact Center Weekly Schedule Setup</b></p> <p>Assign the four Work Schedules (1 ~ 4) to days of the week.</p> <p>The assignments made in this program apply to both the Contact Center Agent Work Schedules (Program 41-05) and the Trunk Work Schedules (Program 41-06).</p>	<p>Day No./Time Pattern:</p> <p>1 = Sunday/ 0 ~ 4 (0 = No Contact Center)</p> <p>2 = Monday/ 0 ~ 4 (0 = No )</p> <p>3 = Tuesday/0 ~ 4 (0 = No )</p> <p>4 = Wednesday/ 0 ~ 4 (0 = No Contact Center)</p> <p>5 = Thursday/ 0 ~ 4 (0 = No Contact Center)</p> <p>(default = 0)</p> <p>6 = Friday/ 0 ~ 4 (0 = No )</p> <p>7 = Saturday/ 0 ~ 4 (0 = No )</p>	0		✓	
41-08-01	<p><b>Overflow Options – Overflow Operation Mode</b></p> <p>Assign the overflow mode (0 ~ 9), destination and announcement message types. Delay Announcement functions are not available for pilot number calls. Each Group can have unique overflow options.</p>	<p>0 = No overflow (None)</p> <p>1 = Overflow with No Announcement</p> <p>2 = No Overflow with First Announcement Only</p> <p>3 = No Overflow with First &amp; Second Announcements</p> <p>4 = Overflow with First Announcement Only</p> <p>5 = Overflow with First and Second Announcement</p> <p>6 = Not Used</p> <p>7 = Not Used</p> <p>8 = No Overflow with Second Announcement Only</p> <p>9 = Overflow with Second Announcement Only</p>	0			✓
41-08-02	<p><b>Overflow Options – Overflow Destination</b></p> <p>Assign the overflow mode (0 ~ 9), destination and announcement message types. Delay Announcement functions are not available for pilot number calls. Each Group can have unique overflow options.</p>	<p>0 = No Setting</p> <p>1 ~ 64 = Group</p> <p>65 = Overflow Table (Program 41-09)</p> <p>66 = Voice Mail Integration</p> <p>67 = System Speed (Program 41-08-05)</p> <p>68 = Incoming Ring Group (Program 41-08-06)</p>	0			✓
41-08-03	<p><b>Overflow Options – Delay Announcement Source Type</b></p> <p>Assign the overflow mode (0 ~ 9), destination and announcement message types. Delay Announcement functions are not available for pilot number calls. Each Group can have unique overflow options.</p>	<p>0 = ACI</p> <p>1 = VRS</p> <p>2 = InMail</p>	1			✓
41-08-04	<p><b>Overflow Options – Overflow Transfer Time</b></p> <p>Define the time before overflow occurs. Each Group can have unique overflow options.</p>	0 ~ 64800 seconds	30			✓

Program Number	Program Name/Description	Input Data	Default	Level		
				1	2	3
41-08-05	<b>Overflow Options – System Speed Dial Bin</b> Assign the speed dial bin to be used as the overflow destination. Using a speed dial bin for Overflow is supported only for off premise calls.	0 ~ 9999 (Used when Program 41-08-02 is set to 5)	9999		✓	
41-08-06	<b>Overflow Options – Incoming Ring Group when Overflow</b> Assign the Ring Group for overflow calls to go to.	1 ~ 100 (Used when Program 41-08-02 is set to 68)	1		✓	
41-09-01	<b>Overflow Table Setting</b> Define the group to which a call is transferred when overflow occurs.	0 ~ 65 0 = No Setting 65 = In-Skin Voice Mail Integration	0		✓	
41-10-01	<b>ACI Delay Announcement – 1st Delay Announcement ACI Port Number</b> Define the ACI port number to be used for the delay announcement. This program is activated when the delay announcement source and options are assigned as ACI in Program 41-08-03.	0 ~ 96 0 = No Setting	0		✓	
41-10-02	<b>ACI Delay Announcement – 2nd Delay Announcement ACI Port Number</b> Define the ACI port number to be used for the delay announcement. This program is activated when the delay announcement source and options are assigned as ACI in Program 41-08-03.	0 ~ 96 0 = No Setting	0		✓	
41-10-03	<b>ACI Delay Announcement – 1st Delay Announcement Connection Timer</b> Define the time before the 1st Delay Announcement is played.	0 ~ 64800 seconds	4		✓	
41-10-04	<b>ACI Delay Announcement – 2nd Delay Announcement Connection Timer</b> Set the time between when the 1st Delay Announcement plays and when the 2nd Delay Announcement plays.	0 ~ 64800 seconds	60		✓	
41-10-05	<b>ACI Delay Announcement – 2nd Delay Announcement Sending Duration</b> Set the time the 2nd Delay Announcement plays. After this time expires, the call disconnects. To keep the call in queue, set this time to 0.	0 ~ 64800 seconds	0		✓	
41-11-01	<b>VRS Delay Announcement – Delay Message Start Timer</b> Set the time before the 1st Delay Message Starts.	0 ~ 64800 seconds	0		✓	



Program Number	Program Name/Description	Input Data	Default	Level		
				1	2	3
41-11-02	<b>VRS Delay Announcement – 1st Delay Message Number</b> Assign the VRS message number to be used as the message source for the 1st and 2nd Delay Announcement Messages. Refer to Program 41-08 for more on setting up the overflow options. This program is activated when the delay announcement source and options are assigned as VRS in Program 41-08-03.	0 ~ 101 0 = No Message 101 = Fixed Message	0		✓	
41-11-03	<b>VRS Delay Announcement – 1st Delay Message Sending Count</b> Input the number of times the 1st Delay Message is sent. If set to 0, the message is not played.	0 ~ 255	0		✓	
41-11-04	<b>VRS Delay Announcement – 2nd Delay Message Number</b> Input the VRS Message to be played as the 2nd Delay Message.	0 ~ 101 0 = No Message 101 = Fixed Message	0		✓	
41-11-05	<b>VRS Delay Announcement – 2nd Waiting Message Sending Count</b> Input the number of times the 2nd Delay Message is sent. If set to 0, the message is not played.	0 ~ 255	0		✓	
41-11-06	<b>VRS Delay Announcement – Tone Kind at Message Interval</b> Input what is heard between the Delay messages.	0 = Ring Back Tone 1 = MOH Tone 2 = BGM Source	0		✓	
41-11-07	<b>VRS Delay Announcement – Forced Disconnect Time after the 2nd Delay Message</b> Set the time, after the last 2nd Delay Message is played, before the call is disconnected.	0 ~ 64800 seconds (0 = No Disconnect)	60		✓	
41-11-08	<b>VRS Delay Announcement – Queue Depth Announcement (Requires VRS)</b> Input when the Queue Depth Announcement will be played.	0 = Disable 1 = After 1st (1st) 2 = After 2nd (2nd) 3 = After 1st and 2nd (1st and 2nd)	0		✓	
41-12-01	<b>Night Announcement Setup – Night Announcement Source Type</b> Define the source for each groups night announcement. Night announcement availability depends on the setting in Program 41-03-02.	0 = ACI 1 = VRS	0		✓	
41-12-02	<b>Night Announcement Setup – Night Announcement ACI Port Number</b> Define the ACI port to be used for the Night Announcement function.	0 ~ 96 0 = No Setting	0		✓	

Program Number	Program Name/Description	Input Data	Default	Level		
				1	2	3
41-12-03	<b>Night Announcement Setup – Night Announce Sending Time</b> Define the time the night Announcement plays. Only used when Program 41-12-01 is set to 0 (ACI). Night announcement availability depends on the setting in Program 41-03-02.	0 ~ 64800 seconds	30		✓	
41-13-01	<b>VRS Message Number for Night Announcement – VRS Message Number</b> Define the VRS message number to be used as the night announcement. This program is activated when the night announcement source is assigned as VRS in Program 41-12-01.	0 ~ 100 0 = No Message	0		✓	
41-13-02	<b>VRS Message Number for Night Announcement – Tone Kind at Message Interval</b> Define what is heard between the Night Announcements.	0 = Ring Back Tone 1 = MOH Tone 2 = BGM Source	0		✓	
41-14-01	<b>Options Setup – Emergency Call Operation Mode</b> Define if Emergency Calls ring the system supervisory extension or not when the group supervisory extension is busy. This option allows the supervisor to press an Emergency Key (programmed for this feature) once to monitor the call or twice to barge in on the call. The supervisor must be logged in for this feature to work.	0 = Call to system supervisory extension when group supervisory extension is busy. 1 = No calls to system supervisory extension when group supervisory extension is busy.	0		✓	
41-14-02	<b>Options Setup – Automatic Wrap Up Mode</b> Define if agents manually enter wrap mode by pressing a key, or are put automatically into wrap mode at end of a call. This setting applies to all agents in the selected group.	0 = After wrap up mode key is pressed (Manual) 1 = After call is finished automatically (Auto)	0		✓	
41-14-03	<b>Options Setup – Priority for Overflow Calls</b> This option determines whether the group should use its own priority assignment or if it should follow the priority assigned in Program 41-03-03.	0 = Own group priority 1 = Priority order by Program 41-03-03	0		✓	
41-14-04	<b>Options Setup – Automatic Answer at Headset</b> Enable (1)/Disable (0) Automatic Answer for agents using headsets.	0 = Off 1 = On	0		✓	
41-14-06	<b>Options Setup – Call Queuing after 2nd Announcement</b> Determine whether the caller should hear the 2nd Delay Announcement and then be taken out of queue (1), or be placed back into queue (0).	0 = Enable (Yes) 1 = Disable (No)	0		✓	

Program Number	Program Name/Description	Input Data	Default	Level		
				1	2	3
41-14-07	<b>Options Setup – Automatic Off Duty for SLT</b> Enable (1)/Disable (0) Automatic Off Duty (rest) mode for agents with single line telephones.	0 = No change to off duty mode 1 = Change to off duty mode automatically (Skip)	0		✓	
41-14-08	<b>Options Setup – Off Duty Mode</b> Enable (1)/Disable (0) the agent's ability to receive internal calls in Off Duty Mode.	0 = Cannot receive internal call 1 = Can receive internal call	0		✓	
41-14-09	<b>Options Setup – Automatic Wrap Up End Time</b> Set the time for the Automatic Wrap Up End Time.	0 ~ 64800 seconds	0		✓	
41-14-10	<b>Options Setup – No Answer Skip Time</b> Set the time a call to the Group rings an idle extension before routing to the next agent.	0 ~ 64800 seconds	10		✓	
41-14-12	<b>Options Setup – Start Headset Ear Piece Ringing (for SLT)</b> Set the ringing start time for the headset ear piece on a single line telephone.	0 ~ 64800 seconds	0		✓	
41-14-13 (1)	<b>Options Setup – Queue 1-Digit Assignment</b> Set various options for Groups. When an option is set for a Group, the setting is in force (if applicable) for all agents in the group. For each Queue (1 ~ 64) assign the One-Digit number (0 ~ 9, *, #) to be used for the One-Digit Dial Out Option.	1st Data: Up to one digit (0, 1 ~ 9, #, *) 2nd Data:	Blank		✓	
41-14-13 (2)	<b>Options Setup – Destination Number Type</b> Set various options for Groups. When an option is set for a Group, the setting is in force (if applicable) for all agents in the group. For each Queue (1 ~ 64), assign the Destination Number Type.	2nd Data: 0 = None 1 = Extension or Voice Mail 2 = Incoming Ring Group 3 = Speed Dial Bin 4 = Group	0		✓	
41-14-13 (3)	<b>Options Setup – Destination Number</b> Set various options for Groups. When an option is set for a Group, the setting is in force (if applicable) for all agents in the group. For each Queue (1 ~ 64), assign the destination number for the assigned Destination Type.	3rd Data: Maximum of eight digits (0, 1 ~ 9, #, *)	Blank		✓	
41-14-14	<b>Options Setup – DTMF Detection Assignment during Delay Announcement</b> Set various options for Groups. When an option is set for a Group, the setting is in force (if applicable) for all agents in the group. For each Queue (1 ~ 64), assign if the One-Digit Dial Out option can (1 = Yes) or cannot (0 = No) be pressed during the Delay Announcements.	0 = Does not detect during message 1 = Detect during message	1		✓	

Program Number	Program Name/Description	Input Data	Default	Level		
				1	2	3
41-14-15	<p><b>Options Setup – DTMF Detect Time after Delay Announcement Message</b></p> <p>Set various options for Groups. When an option is set for a Group, the setting is in force (if applicable) for all agents in the group.</p> <p>For each Queue (1 ~ 64), assign the time after the Delay Announcement that the 1-Digit Dial Out option works.</p>	0 ~ 64800 seconds	0		✓	
41-15-01	<p><b>Queue Alarm Information – Number of Calls in Queue to Activate Alarm Information</b></p> <p>Define the number of calls that must be in queue before the Alarm Information is activated.</p> <p>Do not use these programs if the alarm options are defined in Program 41-20-01 through 41-20-05.</p>	0 ~ 400 0 = No Alarm	0		✓	
41-15-02	<p><b>Queue Alarm Information – Interval Time of Alarm Information</b></p> <p>Define the time the Alarm will ring when activated.</p> <p>Do not use these programs if the alarm options are defined in Program 41-20-01 through 41-20-05.</p>	0 ~ 64800 seconds	0		✓	
41-16-01	<p><b>Threshold Overflow – Number of Calls in Queue</b></p> <p>Define the maximum number of calls allowed in the queue before overflow occurs.</p>	0 ~ 400 (0 = No Limitation)	0		✓	
41-16-02	<p><b>Threshold Overflow – Operation Mode for Queue</b></p> <p>Define how the system should handle calls when the number of calls in queue exceeds the threshold.</p>	0 = The last waiting call is transferred 1 = The longest waiting call is transferred 2 = Send Busy Tone	0		✓	
41-17-01	<p><b>Login Mode Setup</b></p> <p>Define the login mode for each extension. If the AIC Login Mode is enabled, set the AIC Login and AIC Logout service codes for the AIC members in Program 11-13-08 and 11-13-09.</p>	0 = Normal Login Mode 1 = AIC Login Mode	0		✓	
41-18-01	<p><b>Agent Identity Code Setup – Agent Identity Code</b></p> <p>Define the Agent Identity Codes.</p>	Maximum of four digits	No Setting		✓	
41-18-02	<p><b>Agent Identity Code Setup – Default Group Number</b></p> <p>Define the default group for AIC Agents in each AIC table.</p>	0 ~ 64 0 = No Setting	0		✓	
41-18-03	<p><b>Agent Identity Code Setup – Group Number in Mode 1</b></p> <p>For each AIC table, define the group AIC Agents are in during mode 1.</p>	0 ~ 64 0 = No Setting	0		✓	

Program Number	Program Name/Description	Input Data	Default	Level		
				1	2	3
41-18-04	<b>Agent Identity Code Setup – Group Number in Mode 2</b> For each AIC table, define the group AIC Agents are in during mode 2.	0 ~ 64 0 = No Setting	0		✓	
41-18-05	<b>Agent Identity Code Setup – Group Number in Mode 3</b> For each AIC table, define the group AIC Agents are in during mode 3.	0 ~ 64 0 = No Setting	0		✓	
41-18-06	<b>Agent Identity Code Setup – Group Number in Mode 4</b> For each AIC table, define the group AIC Agents are in during mode 4.	0 ~ 64 0 = No Setting	0		✓	
41-18-07	<b>Agent Identity Code Setup – Group Number in Mode 5</b> For each AIC table, define the group AIC Agents are in during mode 5.	0 ~ 64 0 = No Setting	0		✓	
41-18-08	<b>Agent Identity Code Setup – Group Number in Mode 6</b> For each AIC table, define the group AIC Agents are in during mode 6.	0 ~ 64 0 = No Setting	0		✓	
41-18-09	<b>Agent Identity Code Setup – Group Number in Mode 7</b> For each AIC table, define the group AIC Agents are in during mode 7.	0 ~ 64 0 = No Setting	0		✓	
41-18-10	<b>Agent Identity Code Setup – Group Number in Mode 8</b> For each AIC table, define the group AIC Agents are in during mode 8.	0 ~ 64 0 = No Setting	0		✓	
41-19-01	<b>Voice Mail Delay Announcement – Delay Message Start Timer</b> Assign how long the system waits before playing the Delay Message.	0 ~ 64800 seconds	0		✓	
41-19-02	<b>Voice Mail Delay Announcement – Mailbox Number for 1st Announcement Message</b> Assign the Voice Mail Announcement Mailbox as the message source for the 1st Announcement Message.	Dial (maximum of eight digits)	No Setting		✓	
41-19-03	<b>Voice Mail Delay Announcement – 1st Delay Message Sending Count</b> Assign the 1st Delay Message Sending Count. This entry must be set to 1 or higher for the message to play.	1 ~ 255 0 = No message is played	0		✓	
41-19-04	<b>Voice Mail Delay Announcement – Mailbox Number for 2nd Announcement Message</b> Assign the Voice Mail Announcement Mailboxes as the message source for the 2nd Announcement Message.	Dial (maximum of eight digits)	No Setting		✓	

Program Number	Program Name/Description	Input Data	Default	Level		
				1	2	3
41-19-05	<b>Voice Mail Delay Announcement – 2nd Delay Message Sending Count</b> Assign the 2nd Delay Message Sending Count. This entry must be set to 1 or higher for the message to play.	1 ~ 255 0 = No message is played	0		✓	
41-19-06	<b>Voice Mail Delay Announcement – Wait Tone Type at Message Interval</b> Assign what the caller hears between the messages.	0 = Ring Back Tone 1 = Music On Hold Tone 2 = Background Music Source	0		✓	
41-19-07	<b>Voice Mail Delay Announcement – Forced Disconnect Time after 2nd Announcement</b> Assign how long the system waits after the end of the Delay Message before disconnecting.	0 ~ 64800 seconds	0		✓	
41-19-08	<b>Voice Mail Delay Announcement – Delay Message Interval Time</b> Set the time between the Delay Messages.	0 ~ 64800 seconds	20		✓	
41-20-01	<b>Queue Display Settings – Number of Calls in Queue</b> Program 41-15 can also provide a queue alarm to the agents. The options in Program 41-20 should not be used if 41-15 is set. Assign the number of calls that can accumulate in the queue before the Queue Status Display (and optional queue alarm) occurs.	1 ~ 400 0 = No Display	0		✓	
41-20-02	<b>Queue Display Settings – Queue Status Display Time</b> Program 41-15 can also provide a queue alarm to the agents. The options in Program 41-20 should not be used if 41-15 is set. Assign how long the Queue Status display remains on the telephone display.	0 ~ 64800 seconds	5 seconds		✓	
41-20-03	<b>Queue Display Settings – Queue Status Display Interval</b> Program 41-15 can also provide a queue alarm to the agents. The options in Program 41-20 should not be used if 41-15 is set. This option assigns the time that refreshes the Queue Status Alarm time in queue display and causes the optional queue alarm to occur on telephones active on a call, logged out, or in wrap-up.	0 ~ 64800 seconds	60 seconds		✓	
41-20-04	<b>Queue Display Settings – Call Waiting Alarm</b> Program 41-15 can also provide a queue alarm to the agents. The options in Program 41-20 should not be used if 41-15 is set. Enable/Disable the queue alarm.	0 = Disable (Off) 1 = Enable (On)	0		✓	

Program Number	Program Name/Description	Input Data	Default	Level		
				1	2	3
41-20-05	<b>Queue Display Settings – Call Waiting Alarm Hold Time</b> Program 41-15 can also provide a queue alarm to the agents. The options in Program 41-20 should not be used if 41-15 is set. Assign the time the Call Waiting Alarm should sound.	0 ~ 64800 seconds	0		✓	
41-20-06	<b>Queue Display Settings – ACD Queue Display Settings</b> Number of calls to switch the state of ACD Queue Alarm Display Key.	1 ~ 400 0 = No Display	0		✓	
41-21-01	<b>Login ID Setup – Login ID Code</b> Input the Login IDs that will be used.	Up to 20 digits (followed by Program 41-01-02 and Program 41-01-06)	No Setting		✓	
41-21-02	<b>Login ID Setup – Skill Table Number</b> Input the Skill Table number to be used for each Login ID.	0, 1 ~ 960	0		✓	
41-22-01	<b>Skill Based Routing Setup – Skill Base Routing</b> Turn On (1)/Off (0) the Skill Based Routing.	0 = Off 1 = On	0		✓	
41-23-01	<b>Skill Table Setup – Skill Level</b> Input the Skill Level for each Queue for each Skill Table number.	1 ~ 7	1		✓	
41-24-01	<b>Caller ID Marking Setup – Caller ID Marking Setup</b> Enable/Disable the availability of setting that the Agent can mark the originator caller ID, system base.	0 = Disable (Off) 1 = Enable (On)	0		✓	
41-24-02	<b>Caller ID Marking Setup – Agent Info for Caller ID</b> Set whether the Agent ID or extension number of the Agent is used to mark with the CID in the buffer.	0 = Agent Extension Number 1 = Agent ID	0		✓	
41-24-03	<b>Caller ID Marking Setup – Caller ID Buffer Clear Timer</b> Set time interval for clearing stored Caller ID record in buffer.	1 ~ 168 hours	24		✓	
41-24-04	<b>Caller ID Marking Setup – Caller ID Buffer Store Size</b> Set the Caller ID Buffer Size. When the number of CID records is over the limit, CID buffer threshold alarm (71) can be reported.	1000 ~ 10000	10000		✓	

Program Number	Program Name/Description	Input Data	Default	Level		
				1	2	3
47-03-02	<b>SV9100 InMail Group Mailbox Options – Mailbox Number</b> The Group Mailbox Number is the same as the Department Group master (pilot) number. Select the Department Group master (pilot) number associated with the Master Mailbox you are programming.	Maximum of eight digits, using 0 ~ 9). No Setting (entered by pressing Hold)	No Setting		✓	
47-03-03	<b>SV9100 InMail Group Mailbox Options – Mailbox Type</b> Set the Group Mailbox type.	0 = None 1 = Subscriber 2 = Routing	1		✓	
47-07-02	<b>SV9100 InMail Routing Mailbox Options – Routing Mailbox Type</b> Set the Routing Mailbox type.	0 = None 1 = Call Routing 2 = Announcement 3 = Directory 4 = Distribution	Mailboxes 01 ~ 08 = 1 (Call Routing) Mailboxes 09 ~ 32 = 2 (Announcement)		✓	
47-09-03	<b>Announcement Mailbox Options – Hang Up After</b> Use this option along with <i>Next Call Routing Mailbox</i> and <i>Repeat Count</i> above to provide additional routing options to Automated Attendant callers.  For more detail on this interaction, refer to Direct Announcement Mailbox Routing and Routed Announcement Mailbox Routing in the InMail System Guide.	0 = None 1 = Goodbye 2 = Silent	0		✓	

## Operation

### Using the Headset with Automatic Answer for Agents:

1. With the multiline terminal in an idle state, press Feature.
2. Press the **HEADSET** key (Program 15-07-01 or SC 751: 05).
  - ◇ *The Headset key blinks when Automatic Headset is activated.*
  - ◇ *To cancel Automatic Headset, repeat these steps.*

### Transferring Trunk Calls to the Pilot Number:

1. While on an outside call, press **Transfer**.
2. Dial the Pilot number.
3. Hang up.
  - ◇ *The call is transferred to the group.*



**A Supervisor can monitor a call:**

1. When a agent is on an outside call, the supervisor presses the **MONITOR** key (Program 15-07-01 or SC 752: \*15).
  - ◇ *The supervisor can hear but cannot participate in the call. If participation is required, use the Barge-In feature instead.*
2. To cancel the call monitoring, press the **MONITOR** key again.

**AIC Agent Log In:**

**To Log In:**

Multiline Terminal

1. Press the LOG IN/LOG OUT key (Program 15-07-01 or SC 752: \*10).
  - OR -
  - Press Speaker and dial the AIC Log In service code (Program 11-13-08).
2. Dial the log in code (up to 20 digits).
  - ◇ *This step is not required if the ID code is disabled in Program 41-01-02.*
3. Dial the Agent Identity Code (AIC) (up to four digits).
  - ◇ *The **LOG IN/LOG OUT** key lights.*

**To Log Out (for single or multiple agent log ins):**

Multiline Terminal



*All AIC log ins become logged out.*

NOTE

1. Press the LOG IN/LOG OUT key (Program 15-07-01 or SC 752: \*10).
2. Dial **1** to accept.
  - OR -
  - Press Speaker and dial the AIC Log In service code (Program 11-13-08).
  - ◇ *The **LOG IN/LOG OUT** key goes out.*

Single Line Telephone



*All AIC log ins become logged out.*

NOTE

1. Lift the handset.
2. Dial the AIC Log Out service code (Program 11-13-08).
  - OR -

1. To log out of a group without using AIC, lift the handset.
2. Dial the Log Out service code 655 (Program 11-13-02).

### Multiple Agent Log In:

#### To Log In:

##### Multiline Terminal

After already being logged in:

1. Press the LOG IN/LOG OUT key (Program 15-07-01 or SC 752: \*10).
2. Dial **0** to cancel the log out option.
3. Dial the Agent Identity Code (AIC) (up to four digits).
  - ◇ *The **LOG IN/LOG OUT** key lights.*
  - OR -
  - Press Speaker and dial the AIC Log In service code (Program 11-13-08).
4. Dial the Agent Identity Code (AIC) (up to four digits).
  - ◇ *The Log In/Log Out key lights.*

##### Single Line Telephone

Follow Steps 1~3 to log in with additional AICs (up to three) anytime.

1. Lift the handset and dial the AIC Log In service code (Program 11-13-08).
2. Dial the log in code (up to 20 digits).
  - ◇ *This step is not required if the ID code is disabled in Program 41-01-02.*
3. Dial the first Agent Identity Code (AIC) (up to four digits).
  - ◇ *You hear a confirmation tone when immediately logging in with additional AICs.*
4. For second agent log: Dial the second Agent Identity Code (AIC) (up to four digits).
  - ◇ *You hear a confirmation tone.*
5. For third agent log: Dial the third Agent Identity Code (AIC) (up to four digits).
  - ◇ *You hear a confirmation tone.*

### Queue Status Display:

#### When Logged Into Group

1. With an idle multiline terminal, press the Queue Status Display Programmable Function Key (Code: \*19).
  - ◇ *The display indicates the number of calls in queue, the trunk name, and the time the call has been waiting.*
  - ◇ *When the Queue Status Display key is pressed, the queue status of the extension group is displayed. When the extension is not in a group, the Queue Status of group 1 is displayed instead.*

- ◇ *When an agent logs in using an AIC code, the Queue Status of the default group defined in Program 41-18-02 is displayed.*
- 2. Press **VOL UP** and **VOL DOWN** to scroll through the Queue Status Displays of all the Groups.
- 3. Press the **EXIT** key to return the telephone to an idle state.

### When Logged Out of Group

When agents are logged out and a call is placed in the queue, the telephone of the logged out agents displays the Queue Status and they hear the alarm according to the settings defined in system programming.

Pressing the Queue Status Display Programmable Function key returns the telephone to idle until the time in Program 41-20-03 expires again.

### Rest Mode:

#### To Set The Manual Rest Mode:

##### Multiline Terminal

1. With the multiline terminal idle, press the Rest Mode key (Program 15-07-01 or SC 752: \*13).
  - ◇ *The Rest Mode key lights. If the Rest Mode key is pressed while the agent is on an active call, the key flashes until the agent hangs up.*
  - ◇ *This operation is not available for the System Supervisor.*

##### Single Line Telephone

1. Lift the handset and dial 658.
  - ◇ *A fast busy is heard.*
  - ◇ *To set Pre-Rest Mode (while on a call), press the hookflash and then dial 658. Press the Hookflash again to return to the outside party. Rest Mode begins once the call is completed.*
2. Hang up.

#### To Cancel The Manual Rest Mode:

##### Multiline Terminal

1. Press the Rest Mode key (Program 15-07-01 or SC 752: \*13).
  - ◇ *The Rest Mode key light goes off.*

##### Single Line Telephone

1. Lift the handset.
  - ◇ *A fast busy is heard.*
2. Dial **659**.
3. Hang up.

## Continued Dialing

### Description

Continued Dialing allows an extension user to dial a call, wait for the called party to answer, and then dial additional digits. This helps users that need services like Voice Mail, automatic banking and Other Common Carriers (OCCs).

Two types of Continued Dialing are available:

#### Continued Dialing for Intercom Calls

Depending on an extension Class of Service, a multiline terminal user may dial additional digits after their Intercom call connects. In systems with Voice Mail, for example, Continued Dialing lets extension users dial the different options after the Voice Mail answers. Without Continued Dialing, extension users cannot access these Voice Mail options.

#### Continued Dialing for Trunk Calls

Continued Dialing gives a user access to outside services like automatic banking, an outside Automated Attendant, bulletin boards and Other Common Carriers (OCCs). After the outside service answers, the user can dial digits for whatever options the services allow. Without Continued Dialing, the system Toll Restriction cuts off the call after a specific number of dialed digits. See [Guide to Feature Programming on page 2-337](#) for additional information.



CAUTION

*Continued Dialing may make the system more susceptible to toll fraud.*

### Conditions

- The ability to use Continued Dialing on trunk calls is set by Toll Restriction programming.
- Continued Dialing for intercom calls only applies to calls made to analog devices.
- With Pulse to Tone Conversion, users can place calls to services over Dial Pulse trunks – then dial DTMF digits after the service answers.
- When Account Codes are enabled, the user must press the \* three times before the \* character is passed to the telco. The system recognizes the initial \* as the beginning of an Account Code entry, the second \* as the end of an Account Code entry, and the third \* will be passed to telco.

### Default Settings

Enabled

## System Availability

### Terminals

All Multiline Terminals

### Required Component(s)

None

## Related Features

↳ [Pulse to Tone Conversion](#)

## Guide to Feature Programming

The **Level 1**, **Level 2** and **Level 3** columns indicate the programs that are assigned when programming this feature in the order they are most commonly used. These levels are used with PCPro and WebPro wizards for feature programming.

- Level 1 – these are the most commonly assigned programs for this feature.
- Level 2 – these are the next most commonly assigned programs for this feature.
- Level 3 – these programs are not often assigned and require an expert level working knowledge of the system to be properly assigned.

Program Number	Program Name/Description	Input Data	Default	Level		
				1	2	3
15-03-03	<b>Single Line Telephone Basic Data Setup – Terminal Type</b> Enter 1 for this option to allow a single line port to receive DTMF tones after the initial call setup. Enter 0 to have the port ignore DTMF tones after the initial call setup. For Voice Mail, always enter 1 (e.g., receive DTMF tones).	0 = Normal 1 = Special	0	✓		
20-06-01	<b>Class of Service for Extensions</b> Assign a Class of Service (1 ~ 15) to extensions.	Day Night/Mode: 1 ~ 8 Class of Service of Extensions (1 ~ 15)	Extension port 101 = Class 15 All other extension port = Class 1	✓		
20-13-13	<b>Class of Service Options (Supplementary Service) – Continued Dialing (DTMF) Signal on ICM Call</b> Turn Off or On an extension user ability to use Continued Dialing, which allows DTMF signal sending while talking on extension.	0 = Off 1 = On	COS 1 ~ 15 = 1	✓		

Program Number	Program Name/Description	Input Data	Default	Level		
				1	2	3
21-04-01	<b>Toll Restriction Class for Extensions</b> Assign a Toll Restriction Class (1~15) to an extension.	Day/Night Mode 1 ~ 9 (9 = Power Failure Mode) Restriction Class 1 ~ 15	2	✓		
21-05-04	<b>Toll Restriction Class – Maximum Number of Digits Table Assignment</b> Select the table (defined in Program 21-06-03) to be used to determine the maximum number of digits allowed for outgoing calls.	1 ~ 4 = Table 0 =Disable (None)	1, 2, 6 ~ 15 = 0 3 = 1 4 = 2 5 = 3	✓		
21-06-03	<b>Toll Restriction Table Data Setup – Maximum Number of Digits Table Assignment</b> Set the Maximum Number of digits dialed for each table.	4 ~ 30	Tables 1 ~ 4 = 30	✓		

## Operation

### To use Continued Dialing:

1. Place an intercom or trunk call.
2. Continue dialing after the call connects.
  - ◇ *Toll Restriction and Class of Service programming may limit Continued Dialing.*

## Cordless DECT Terminals

### Description

The Cordless DECT Terminals may be used with the UNIVERGE SV9100 KTS. The DTL-8R-1 and DTZ-8R-1 TEL uses 1.9 GHz DECT 6.0 FM Technology and is connected in tandem to a multiline terminal.



— Refer to specific DECT Owner’s Manual for more information on the DTL-8R-1 and DTZ-8R-1 terminal.

Press the applicable key on the Base Unit to Switch between Cordless operation and multiline terminal operation.

Feature	Specifications
<b>DTL-8R-1</b>	
Digital Technology	1.9 GHz 6.0
LCD	2-line, 24-digit LCD Display
Silent Alarm	Yes
Dedicated Keys	TALK, TRANSFER, HOLD, CONF, SPEAKER, REDIAL, MUTE, R/VOL
Programmable Line Keys	8
Operational Range *	50~150 feet (expandable with repeaters)
Message Waiting Indication	Yes (Icon)
Headset Connection	Yes
Channels	5 channels by 12 time slots
<b>DTZ-8R-1</b>	
Digital Technology	1.9 GHz (1920 ~ 1930 MHz)
LCD	2-line, 16-digit LCD Display
Dedicated Keys	TALK, MUTE, SPEAKER, END CALL
Softkeys	Hold, Conf, Trans, Redial, Volume
Programmable Line Keys	8
Operational Range *	164 feet (Indoor), 984 feet (Outdoor)
Message Waiting Indication	Yes (Icon)
Headset Connection	Yes
Channels	5 channels

\* Determined by environmental conditions. These are cordless RF devices and, therefore, some interference may take place when operating in the same environment as other wireless devices which operate within the same frequency spectrum.

## Conditions

- With the DTL-8R-1, if using the Base Switching option, Cordless DECT Terminal programmable keys:
  - 1~4 can be set as a Programmable Function key such as Trunk Line Keys
  - 5 and 6 can be set as Programmable Function keys
  - 7 and 8 are reserved for Base Switching and cannot be programmed
- If the Base Switching option for the DTL-8R-1 is **not** used, programmable keys 1~8 can be programmed as Programmable Function Keys such as Trunk Line Keys.
- If the Base Key Option of the DTZ-8R-1 is enabled, Desk and H/S softkeys will appear allowing the user to switch between desk and handset modes.
- The DTL-8R-1 Cordless DECT Terminals can be used in conjunction with the UNIVERGE SV9100 and DT400/DT300 Digital Multiline Telephones.
- The DTZ-8R-1 Cordless DECT Terminals can be used in conjunction with the UNIVERGE SV9100 and DT400/DT300 Digital Multiline Telephones.
- Battery Capacity is 910 mAh, 2.4V with a Talk Mode of 16 hours (typical) and a Standby Mode of seven days (typical).
- The handset has visual and audible indicators to warn of a low battery condition.
- When a message is received, the message icon is displayed.
- Synchronous Ringing does not apply to the cordless terminals.
- A beep indicates when the cordless terminal receives off-hook ringing.
- For the DTL-8R-1, a spare battery is available as an Optional Available Part. A second battery is not shipped with the product.
- With the DTL-8R-1, the battery can be charged when it is installed in the handset or in the base charging unit and the handset is in the charger. A stand-alone battery charger is not available.
- Environments with many metal parts, metal shelves, or metal buildings are known to reduce telephone performance.
- When multiple cordless telephones are used in your office, they must operate on different channels and be at least 20 feet apart (including the base unit and the telephones).
- The DTL-8R-1 and DTZ-8R-1 Cordless DECT telephones are not supported as door phone ringing members in Program 32-02.
- Cordless DECT telephones can activate the door strike relay using a Flash Key assigned to one of the line keys in Program 15-07 (751: 62).
- Under certain conditions, HOLD and TRANSFER have the same behavior. To prevent an unwanted transfer after placing a call on hold and calling another user, the Line Key for the call on hold must be pressed to retrieve the call from hold, otherwise the call is transferred when the Cordless Terminal is placed in idle.



- The DTL-8R-1 DECT Cordless – only supports connection with DT400/DT300 terminals.
- The DTZ-8R-1 DECT Cordless – only supports connection with DT400/DT300 terminals.
- DTH-4R-1/2 Cordless is not supported on the SV9100.
- While on a call, press the Center key to access the Programmable Function keys. Then, using the Up/Down or Left/Right arrow keys navigate to the desired function key. Press the Center key again to select/highlight the function key (DTZ-8R-1 only).
- The caller hears a click when the Center key or arrow keys are pressed during an active call (DTZ-8R-1 only).

### Restrictions

- Cordless terminals cannot receive voice announcements when idle.

### Default Settings

None

## System Availability

### Terminals

DTL-8R-1 TEL

DTZ-8R-1 TEL

### Required Component(s)

- GCD-8DLCA Blade with GPZ-8DLCB Daughter Board
- GCD-CP10 with GPZ-IPLE Daughter board
- SIP telephone licenses

**-OR-**

CD-16DLCA

## Related Features

➔ [Cordless Telephone Connection](#)

## Guide to Feature Programming

The **Level 1**, **Level 2** and **Level 3** columns indicate the programs that are assigned when programming this feature in the order they are most commonly used. These levels are used with PCPro and WebPro wizards for feature programming.

- Level 1 – these are the most commonly assigned programs for this feature.
- Level 2 – these are the next most commonly assigned programs for this feature.
- Level 3 – these programs are not often assigned and require an expert level working knowledge of the system to be properly assigned.

◇ *The items highlighted in gray are read only and cannot be changed.*

Program Number	Program Name/Description	Input Data	Default	Level		
				1	2	3
10-03-01	<b>ETU Setup (DLCA PKG Setup) – Terminal Type (B1)</b> Setup and confirm the Basic Configuration data for terminal type (B1).	0 = Not set 1 = Multiline Terminal 3 = Bluetooth Cordless Handset 6 = PGD (Paging) 7 = PGD (Tone Ringer) 8 = PGD (Doorbox) 9 = PGD (ACI) 10 = DSS Console 11 = -- Not Used --	0		✓	
10-03-02	<b>ETU Setup (DLCA PKG Setup) – Logical Port Number (B1)</b> Use to setup and confirm the Basic Configuration data for logical port number (B1).	0 = Not set 1 = Multiline Terminal (1 ~ 960 6 = PGD(2)-U10 ADP (Paging) (1 ~ 8) 7 = PGD(2)-U10 ADP (for Tone Ringer) (1 ~ 8) 8 = PGD(2)-U10 ADP (for Door Box) (1 ~ 8) 9 = PGD(2)-U10 ADP (for ACI) (1 ~ 96) 10 = DSS (1 ~ 32) 11 = -- Not Used --	0		✓	
10-03-05	<b>ETU Setup (DLCA PKG Setup) – Optional Installed Unit 2</b> Use to setup and confirm the Basic Configuration data for optional installed Unit 2.	0 = None 1 = APR Module 2 = APA Module 3 = ADA Module 4 = CTA/CTU Module	0		✓	

Program Number	Program Name/Description	Input Data	Default	Level		
				1	2	3
10-03-06	<b>ETU Setup (DLCA PKG Setup) – Terminal Type (B2)</b> Setup and confirm the Basic Configuration data for terminal type.	0 = Not set 6 = PGD(2)-U10 ADP (Paging) 7 = PGD(2)-U10 ADP (Tone Ringer) 8 = PGD(2)-U10 ADP (Door Box) 9 = PGD(2)-U10 ADP (ACI) 12 = APR (B2 Mode)	0		✓	
10-03-07	<b>ETU Setup (DLCA PKG Setup) – Logical Port Number (B2)</b> Use to setup and confirm the Basic Configuration data for logical port number (B2).	0 = Not Set 6 = PGD(2)-U10 ADP (Ext. Speaker) 7 = PGD(2)-U10 ADP (Paging/ Tone Ringer = 1 ~ 8) 8 = PGD(2)-U10 ADP (for Door Box = 1 ~ 8) (ACI) = (1 ~ 96) 9 = PGD(2)-U10 ADP 12 = APR (for B2 Mode) (193 ~ 960)	0		✓	
10-03-08	<b>ETU Setup (DLCA PKG Setup) – Multiline Telephone Type</b> Read only program that shows the type of multiline terminal connected to the port.	0 = DT3** 1 = Dterm8 2 = Dterm7	0		✓	
10-03-09	<b>ETU Setup (DLCA PKG Setup) – Side Option Information</b> Read only command that shows the type of side module connected to the terminal.	0 = No Option 1 = 8LK Unit 2 = 16LK Unit 3 = 24ADM	0		✓	
10-03-10	<b>ETU Setup (DLCA PKG Setup) – Bottom Option Information (Only applies to DTL style telephones)</b> Shows optional adapter information.	0 = No option 1 = APR 2 = ADA 3 = BHA	0		✓	
10-03-11	<b>ETU Setup (DLCA PKG Setup) – Handset Option Information</b> Shows optional adapter information.	0 = No option 1 = PSA/PSD 2 = Bluetooth Cordless Handset	0		✓	
11-11-16	<b>Service Code Setup (for Setup/Entry Operation) – Enable Force Ringing of Incoming Intercom Calls</b> Allows a telephone to be manually set to ring when called if the system is set to voice announce in Program 20-02-12.	MLT, SLT 0 ~ 9, *, # Maximum of eight digits	775		✓	
20-07-01	<b>Class of Service Options (Administrator Level) – Manual Night Service Enabled</b> Turn Off or On an extension for manually Switching the Night Mode (Service Code 718). This option must be enabled for an extension to be able to display the Night indication.	0 = Off 1 = On	COS 1 ~ 14 = 0 COS 15 = 1			✓

Program Number	Program Name/Description	Input Data	Default	Level		
				1	2	3
20-07-03	<b>Class of Service Options (Administrator Level) – Time Setting</b> Turn Off or On an extension user ability to set the Time via Service Code 728.	0 = Off 1 = On	COS 1 ~ 15 = 1			✓
20-07-05	<b>Class of Service Options (Administrator Level) – Set/Cancel Automatic Trunk-to-Trunk Transfer</b> Turn Off or On the ability of an extension to use the Trunk-to-Trunk Forwarding service codes.	0 = Off 1 = On	COS 1 ~ 15 = 0			✓
20-07-11	<b>Class of Service Options (Administrator Level) – Forced Trunk Disconnect (analog trunk only)</b> Turn Off or On an extension to use Forced Trunk Disconnect. This allows the extension to disconnect an Unsupervised Conference in progress.	0 = Off 1 = On	COS 1 ~ 14 = 0 COS 15 = 1			✓
20-07-12	<b>Class of Service Options (Administrator Level) – Trunk Port Disable</b> Turn Off or On the extension ability to use the Trunk Port Disable feature.	0 = Off 1 = On	COS 1 ~ 14 = 0 COS 15 = 1			✓
20-07-13	<b>Class of Service Options (Administrator Level) – VRS Record (VRS Msg Operation)</b> Turn Off or On an extension user ability to record, erase and listen to VRS messages.	0 = Off 1 = On	COS 1 ~ 14 = 0 COS 15 = 1			✓
20-07-14	<b>Class of Service Options (Administrator Level) – VRS General Message Play</b> Turn Off or On an extension user ability to dial 4 or Service Code 611 to listen to the General Message.	0 = Off 1 = On	COS 1 ~ 14 = 0 COS 15 = 1			✓
20-07-15	<b>Class of Service Options (Administrator Level) – VRS General Message Record/Delete</b> Turn Off or On an extension user ability to dial Service Code 612 and record, listen to, or erase the General Message.	0 = Off 1 = On	COS 1 ~ 14 = 0 COS 15 = 1			✓
20-07-18	<b>Class of Service Options (Administrator Level) – SMDR Printout Accumulated Extension Data</b> Define if Accumulated Extension Data is included in the SMDR Printout for each Class of Service.	0 = Off 1 = On	COS 1 ~ 14 = 0 COS 15 = 1			✓
20-07-19	<b>Class of Service Options (Administrator Level) – SMDR Printout Department Group (STG) Data</b> Define if Department Group (STG) Data is included in the SMDR Printout for each Class of Service.	0 = Off 1 = On	COS 1 ~ 14 = 0 COS 15 = 1			✓

Program Number	Program Name/Description	Input Data	Default	Level		
				1	2	3
20-07-20	<b>Class of Service Options (Administrator Level) – SMDR Printout Accumulated Account Code Data</b> Define if Accumulated Account Code Data is included in the SMDR Printout for each Class of Service.	0 = Off 1 = On	COS 1 ~ 14 = 0 COS 15 = 1			✓
20-07-23	<b>Class of Service Options (Administrator Level) – CO Message Waiting Indication Callback Number Programming</b> Enable/Disable an extension ability to receive CO Message Waiting Indication.	0 = Off 1 = On	COS 1 ~ 15 = 0			✓
20-07-24	<b>Class of Service Options (Administrator Level) – Set/Cancel Private Call Refuse</b> Enable/Disable an extension user ability to set or cancel Private Call Refuse.	0 = Off 1 = On	COS 1 ~ 15 = 0			✓
20-07-25	<b>Class of Service Options (Administrator Level) – Set/Cancel Caller ID Refuse</b> Enable/Disable an extension user ability to set or cancel Caller ID Refuse.	0 = Off 1 = On	COS 1 ~ 15 = 0			✓
20-07-26	<b>Class of Service Options (Administrator Level) – Dial-In Mode Switch</b> Enable/Disable an extension user ability to set or cancel dial-in mode switch.	0 = Off 1 = On	COS 1 ~ 15 = 0			✓
20-07-27	<b>Class of Service Options (Administrator Level) – Do-Not-Call Administrator</b> Enable/Disable an extension user ability to set or cancel do not call administrator.	0 = Off 1 = On	COS 1 ~ 15 = 0			✓
20-08-01	<b>Class of Service Options (Outgoing Call Service) – Intercom Calls</b> Turn Off or On Intercom calling for the extension.	0 = Off 1 = On	COS 1 ~ 15 = 1			✓
20-08-02	<b>Class of Service Options (Outgoing Call Service) – Trunk Outgoing Calls</b> Turn Off or On outgoing trunk calling for the extension.	0 = Off 1 = On	COS 1 ~ 15 = 1			✓
20-08-03	<b>Class of Service Options (Outgoing Call Service) – System Speed Dialing</b> Turn Off or On an extension user ability to make outbound calls using system speed dial numbers.	0 = Off 1 = On	COS 1 ~ 15 = 1			✓
20-08-04	<b>Class of Service Options (Outgoing Call Service) – Group Speed Dialing</b> Turn Off or On an extension user ability to make outbound calls using group speed dial numbers.	0 = Off 1 = On	COS 1 ~ 15 = 1			✓

Program Number	Program Name/Description	Input Data	Default	Level		
				1	2	3
20-08-06	<b>Class of Service Options (Outgoing Call Service) – Toll Restriction Override</b> Turn Off or On Toll Restricting Override (Service Code 663).	0 = Off 1 = On	COS 1 ~ 15 = 0		✓	
20-08-07	<b>Class of Service Options (Outgoing Call Service) – Repeat Redial</b> Turn Off (0) or On (1) an extension to use Repeat Redial.	0 = Off 1 = On	COS 1 ~ 15 = 1		✓	
20-08-08	<b>Class of Service Options (Outgoing Call Service) – Toll Restriction Dial Block</b> Turn Off or On an extension ability to use Dial Block.	0 = Off 1 = On	COS 1 ~ 15 = 0		✓	
20-08-09	<b>Class of Service Options (Outgoing Call Service) – Hotline/Extension Ringdown</b> Turn Off or On Ringdown Extension for extensions with this COS.	0 = Off 1 = On	COS 1 ~ 15 = 0		✓	
20-08-10	<b>Class of Service Options (Outgoing Call Service) – Signal/Voice Call</b> Turn Off or On an extension allowing it to force Handsfree Answerback or Forced Intercom Ringing for outgoing Intercom calls.	0 = Off 1 = On	COS 1 ~ 15 = 1		✓	
20-08-11	<b>Class of Service Options (Outgoing Call Service) – Protect for the Call Mode Switching from Caller</b> When an extension is set to ring mode for ICM calls, enabling this option prevents callers from changing the call to voice announce mode.	0 = Off 1 = On	COS 1 ~ 15 = 0		✓	
20-08-12	<b>Class of Service Options (Outgoing Call Service) – Department Group Step Calling</b> Turn Off or On an extension user ability to use Department Group Step Calling.	0 = Off 1 = On	COS 1 ~ 15 = 1		✓	
20-08-13	<b>Class of Service Options (Outgoing Call Service) – ISDN CLIP</b> Determine if the ISDN calling line identity presentation and screening indicators are to be allowed.	0 = Off 1 = On	COS 1 ~ 15 = 0		✓	
20-08-14	<b>Class of Service Options (Outgoing Call Service) – Call Address Information</b> Enable/Disable Call Address Information for each Class Of Service.	0 = Off 1 = On	COS 1 ~ 15 = 0		✓	

Program Number	Program Name/Description	Input Data	Default	Level		
				1	2	3
20-08-15	<p><b>Class of Service Options (Outgoing Call Service) – Block Outgoing Caller ID</b></p> <p>Turn Off or On a user Class of Service from automatically blocking outgoing Caller ID information when a call is placed. If block is enabled, the system automatically inserts the Caller ID block code *67 (defined in Program 14-01-21) before the user dialed digits (this requires Program 14-02-10 to be enabled). If block is disabled, the system outdials the call just as it was dialed by the user.</p>	<p>0 = Off 1 = On</p>	COS 1 ~ 15 = 0		✓	
20-08-16	<p><b>Class of Service Options (Outgoing Call Service) – Display E911 Dialed Extension Name and Number</b></p> <p>Turn Off or On an extension ability to display the name and number of the extension that dialed 911.</p>	<p>0 = Off 1 = On</p>	COS 1 ~ 15 = 0		✓	
20-08-17	<p><b>Class of Service Options (Outgoing Call Service) – ARS Override of Trunk Access Map</b></p> <p>Turn Off or On an extension user ability to override the trunk access map programming for outgoing calls.</p>	<p>0 = Off 1 = On</p>	COS 1 ~ 15 = 0		✓	
20-08-22	<p><b>Class of Service Options (Outgoing Call Service) – Voice Over to busy Virtual Extension</b></p> <p>Enable/Disable an extension ability to voice over to a busy virtual extension.</p>	<p>0 = Off 1 = On</p>	COS 1 ~ 15 = 0		✓	
20-09-01	<p><b>Class of Service Options (Incoming Call Service) – Second Call for DID/DISA/DIL/ E&amp;M Override</b></p> <p>Turns Off or On the extension ability to receive a second call from a DID, DISA, DIL, or tie line caller.</p> <p>➡ <i>With this option set to 1, the destination extension must be busy for a second DNIS caller to ring through. If the destination extension does not have a trunk or CAP key available for the second call and a previous call is ringing the extension but has not yet been answered, the second caller hears busy regardless of this program setting.</i></p>	<p>0 = Off 1 = On</p>	COS 1 ~ 15 = 1		✓	
20-09-02	<p><b>Class of Service Options (Incoming Call Service) – Caller ID Display</b></p> <p>Turn Off or On the Caller ID display at an extension.</p>	<p>0 = Off 1 = On</p>	COS 1 ~ 15 = 0		✓	
20-09-03	<p><b>Class of Service Options (Incoming Call Service) – Sub Address Identification</b></p> <p>Define whether an extension displays the Caller Sub-Address.</p>	<p>0 = Off 1 = On</p>	COS 1 ~ 15 = 0		✓	

Program Number	Program Name/Description	Input Data	Default	Level		
				1	2	3
20-09-04	<b>Class of Service Options (Incoming Call Service) – Notification for Incoming Call List Existence</b> Determine whether or not the CHECK LIST message is displayed to indicate a missed call.	0 = Off 1 = On	COS 1 ~ 15 = 0		✓	
20-09-05	<b>Class of Service Options (Incoming Call Service) – Signal/Voice Call</b> Turn Off or On an extension user ability to enable Handsfree Answerback or Forced Intercom Ringing for their incoming Intercom calls.	0 = Off 1 = On	COS 1 ~ 15 = 1		✓	
20-09-06	<b>Class of Service Options (Incoming Call Service) – Incoming Time Display</b> If this option is set to 1, the Incoming Call Time is displayed on the multiline terminal LCD while the telephone is ringing. ➔ <i>Caller ID should be enabled for this feature in Program 20-09-06 to function.</i>	0 = Off 1 = On	COS 1 ~ 15 = 0		✓	
20-09-07	<b>Class of Service Options (Incoming Call Service) – Call Queuing</b> Turn Off or On an extension ability to have calls queued if a call rings the extension when it is busy. ➔ <i>Program 20-13-06 must be set to 0 (Off) for this feature to work.</i>	0 = Off 1 = On	COS 1 ~ 15 = 1		✓	
20-09-08	<b>Class of Service Options (Incoming Call Service) – Calling Party Information</b> Turn Off or On and extension ability to display calling party information on CCIS calls.	0 = Off 1 = On	COS 1 ~ 15 = 1		✓	
20-10-01	<b>Class of Service Options (Answer Service) – Group Call Pickup (Within Group)</b> Turn Off or On Group Call Pickup for calls ringing an extension Pickup Group as well as ring group calls (Service Code *#).	0 = Off 1 = On	COS 1 ~ 15 = 1		✓	
20-10-02	<b>Class of Service Options (Answer Service) – Group Call Pickup (Another Group)</b> Turn Off or On Group Call Pickup for calls ringing outside a group (Service Code 769).	0 = Off 1 = On	COS 1 ~ 15 = 1		✓	
20-10-03	<b>Class of Service Options (Answer Service) – Group Call Pickup for Specific Group</b> Turn Off or On Group Call Pickup for a specific group using service code 768.	0 = Off 1 = On	COS 1 ~ 15 = 1		✓	
20-10-04	<b>Class of Service Options (Answer Service) – Telephone Call Pickup</b> Enable or Disable the group call pickup.	0 = Off 1 = On	COS 1 ~ 15 = 1		✓	



Program Number	Program Name/Description	Input Data	Default	Level		
				1	2	3
20-10-05	<b>Class of Service Options (Answer Service) – Directed Call Pickup for Own Group</b> Turn Off or On Directed Call Pickup for calls ringing an extension Pickup Group (Service Code 756).	0 = Off 1 = On	COS 1 ~ 15 = 1		✓	
20-10-06	<b>Class of Service Options (Answer Service) – Meet-Me Conference and Paging</b> Turns Off or On an extension to use Meet-Me Conference and Paging.	0 = Off 1 = On	COS 1 ~ 15 = 1		✓	
20-10-07	<b>Class of Service Options (Answer Service) – Automatic Off-Hook Answer</b> Turns Off or On an extension to use Universal Auto Answer (no service code required).	0 = Off 1 = On	COS 1 ~ 15 = 0			✓
20-10-08	<b>Class of Service Options (Answer Service) – Virtual Extension Off-Hook Answer</b> Turns Off or On an extension ability to answer an incoming call on a Call Arrival (CAR)/ Secondary Incoming Extension (SIE)/ Virtual Extension simply by lifting the handset.	0 = Off 1 = On	COS 1 ~ 15 = 1			✓
20-10-09	<b>Class of Service Options (Answer Service) – Call Pickup Callback</b> Turn off or on an extension ability to use Call Pickup to Pick up Callback calls.	0 = Off 1 = On	COS 1 ~ 15 = 1			✓
20-11-01	<b>Class of Service Options (Hold/Transfer Service) – Call Forward All</b> Turn Off or On an extension user ability to set Call Forward Immediate.	0 = Off 1 = On	COS 1 ~ 15 = 1			✓
20-11-02	<b>Class of Service Options (Hold/Transfer Service) – Call Forward When Busy</b> Turn Off or On an extension user ability to set Call Forwarding when Busy.	0 = Off 1 = On	COS 1 ~ 15 = 1			✓
20-11-03	<b>Class of Service Options (Hold/Transfer Service) – Call Forwarding When Unanswered</b> Turn Off or On an extension user ability to set Call Forwarding when Unanswered.	0 = Off 1 = On	COS 1 ~ 15 = 1			✓
20-11-04	<b>Class of Service Options (Hold/Transfer Service) – Call Forwarding (Both Ringing)</b> Turn Off or On an extension user ability to set Call Forwarding with Both Ringing.	0 = Off 1 = On	COS 1 ~ 15 = 1			✓
20-11-05	<b>Class of Service Options (Hold/Transfer Service) – Call Forwarding with Follow Me</b> Turn Off or On an extension user ability to set Call Forward with Follow Me.	0 = Off 1 = On	COS 1 ~ 15 = 1			✓

Program Number	Program Name/Description	Input Data	Default	Level		
				1	2	3
20-11-06	<b>Class of Service Options (Hold/Transfer Service) – Unscreened Transfer (Ring Inward Transfer)</b> Turn Off or On an extension ability to use Unscreened Transfer.	0 = Off 1 = On	COS 1 ~ 15 = 1			✓
20-11-07	<b>Class of Service Options (Hold/Transfer Service) – Transfer Without Holding</b> Turn Off or On an extension ability to use Transfer Without Holding.	0 = Off 1 = On	COS 1 ~ 15 = 0			✓
20-11-08	<b>Class of Service Options (Hold/Transfer Service) – Transfer Information Display</b> Turn Off or On an extension incoming Transfer pre-answer display.	0 = Off 1 = On	COS 1 ~ 15 = 1			✓
20-11-09	<b>Class of Service Options (Hold/Transfer Service) – Group Hold Initiate</b> Turn Off or On an extension user ability to initiate a Group Hold.	0 = Off 1 = On	COS 1 ~ 15 = 1			✓
20-11-10	<b>Class of Service Options (Hold/Transfer Service) – Group Hold Answer</b> Turn Off or On an extension user ability to pick up a call on Group Hold.	0 = Off 1 = On	COS 1 ~ 15 = 1			✓
20-11-11	<b>Class of Service Options (Hold/Transfer Service) – Automatic On-Hook Transfer</b> Turn Off or On an extension user ability to use Automatic On-Hook Transfer.	0 = Off 1 = On	COS 1 ~ 15 = 0			✓
20-11-12	<b>Class of Service Options (Hold/Transfer Service) – Call Forwarding Off-Premise (External Call Forwarding)</b> Turn Off or On setting up Call Forwarding Off-Premise at the extension.	0 = Off 1 = On	COS 1 ~ 15 = 0			✓
20-11-13	<b>Class of Service Options (Hold/Transfer Service) – Operator Transfer After Hold Callback</b> Turn Off or On an extension ability to have a call which recalls from hold transfer to the operator.	0 = Off 1 = On	COS 1 ~ 15 = 0			✓
20-11-14	<b>Class of Service Options (Hold/Transfer Service) – Trunk-to-Trunk Transfer Restriction</b> Turn Off or On the Trunk-to-Trunk Transfer Restriction. If enabled, Trunk-to-Trunk Transfer is not possible.	0 = Off 1 = On	COS 1 ~ 15 = 0			✓
20-11-15	<b>Class of Service Options (Hold/Transfer Service) – VRS Personal Greeting (Message Greeting)</b> Turn Off or On an extension user ability to dial Service Code 616 to record, listen to or erase the Personal Greeting Message.	0 = Off 1 = On	COS 1 ~ 15 = 1			✓

Program Number	Program Name/Description	Input Data	Default	Level		
				1	2	3
20-11-16	<b>Class of Service Options (Hold/Transfer Service) – Call Redirect</b> Turn Off or On an extension user ability to transfer a call to a predefined destination (such as an operator, voice mail, or another extension) without answering the call.	0 = Off 1 = On	COS 1 ~ 15 = 1			✓
20-11-17	<b>Class of Service Options (Hold/Transfer Service) – Department Group Trunk-to-Trunk Transfer (Each Telephone Group Transfer)</b> Turn Off or On an extension user in a Department Group ability to use the Trunk-to-Trunk Forwarding service codes.	0 = Off 1 = On	COS 1 ~ 15 = 1			✓
20-11-18	<b>Class of Service Options (Hold/Transfer Service) – No Recall</b> Allow (0)/Deny (1) answered Transferred calls from recalling the originating extension.	0 = Off 1 = On	COS 1 ~ 15 = 0			✓
20-11-19	<b>Class of Service Options (Hold/Transfer Service) – Hold/Extended Park</b> Determine whether an extension Class of Service should allow normal (0) or extended Park (1).	0 = Off 1 = On	COS 1 ~ 15 = 0			✓
20-11-20	<b>Class of Service Options (Hold/Transfer Service) – No Callback</b> Turn Off or On an extension ability to receive Callbacks.	0 = Off 1 = On	COS 1 ~ 15 = 0			✓
20-11-21	<b>Class of Service Options (Hold/Transfer Service) – Restriction for Tandem Trunking on Hang Up</b> Allow/Deny an extension user ability to set up a tandem/conference call automatically when they hang up.	0 = Off 1 = On	COS 1 ~ 15 = 0			✓
20-11-22	<b>Class of Service Options (Hold/Transfer Service) – Restricted Unsupervised Conference</b> Allow/Deny an extension user ability to initiate a Trunk-to-Trunk Transfer (Tandem Trunking).	0 = Off 1 = On	COS 1 ~ 15 = 0			✓
20-11-23	<b>Class of Service Options (Hold/Transfer Service) – CAR/VE Call Forward Set/Cancel</b> Turn Off or On an extension user ability to set and cancel Call Forwarding for a CAR or Virtual Extension.	0 = Off 1 = On	COS 1 ~ 15 = 1			✓
20-11-24	<b>Class of Service Options (Hold/Transfer Service) – Trunk Park Hold Mode</b> Set the hold type when a trunk call is put on hold by an extension.	0 = Non Exclusive Hold (Off) 1 = Exclusive Hold (On)	COS 1 ~ 15 = 1			✓

Program Number	Program Name/Description	Input Data	Default	Level		
				1	2	3
20-11-25	<b>Class of Service Options (Hold/Transfer Service) – Transfer Park Call</b> Turn Off or On an extension user ability to transfer a parked call.	0 = Off 1 = On	COS 1 ~ 15 = 1			✓
20-13-01	<b>Class of Service Options (Supplementary Service) – Long Conversation Alarm</b> Turn Off or On the Warning Tone for Long Conversation (not for single line telephones).	0 = Off 1 = On	COS 1 ~ 15 = 0			✓
20-13-02	<b>Class of Service Options (Supplementary Service) – Long Conversation Cutoff (Incoming)</b> Turn Off or On an extension user ability to use Long Conversation Cutoff for incoming calls.	0 = Off 1 = On	COS 1 ~ 15 = 0			✓
20-13-03	<b>Class of Service Options (Supplementary Service) – Long Conversation Cutoff (Outgoing)</b> Turn Off or On an extension user ability to use Long Conversation Cutoff for outgoing calls.	0 = Off 1 = On	COS 1 ~ 15 = 0			✓
20-13-04	<b>Class of Service Options (Supplementary Service) – Call Forward/DND Override (Bypass Call)</b> Turn On or Off the ability to use Call Forwarding/DND Override.	0 = Off 1 = On	COS 1 ~ 15 = 1			✓
20-13-07	<b>Class of Service Options (Supplementary Service) – Message Waiting</b> Turn Off or On an extension user ability to leave Message Waiting.	0 = Off 1 = On	COS 1 ~ 15 = 1			✓
20-13-08	<b>Class of Service Options (Supplementary Service) – Conference</b> Turn Off or On an extension user ability to initiate a conference or Meet Me Conference.	0 = Off 1 = On	COS 1 ~ 15 = 1			✓
20-13-09	<b>Class of Service Options (Supplementary Service) – Privacy Release</b> Turn Off or On an extension user ability to initiate a Voice Call Conference.	0 = Off 1 = On	COS 1 ~ 15 = 1			✓
20-13-10	<b>Class of Service Options (Supplementary Service) – Barge-In Monitor</b> Enable the Barge-In Speech Mode) or Monitor Mode at the initiating extension (i.e., Barge-In initiator).	0 = Off 1 = On	COS 1 ~ 15 = 0			✓
20-13-11	<b>Class of Service Options (Supplementary Service) – Room Monitor, Initiating Extension</b> Turn Off or On an extension user ability to Room Monitor other extensions.	0 = Off 1 = On	COS 1 ~ 15 = 0			✓

Program Number	Program Name/Description	Input Data	Default	Level		
				1	2	3
20-13-12	<b>Class of Service Options (Supplementary Service) – Room Monitor, Extension Being Monitored</b> Turn Off or On an extension ability to be monitored by other extensions.	0 = Off 1 = On	COS 1 ~ 15 = 0			✓
20-13-13	<b>Class of Service Options (Supplementary Service) – Continued Dialing (DTMF) Signal on ICM Call</b> Turn Off or On an extension user ability to use Continued Dialing, which allows DTMF signal sending while talking on extension.	0 = Off 1 = On	COS 1 ~ 15 = 1			✓
20-13-14	<b>Class of Service Options (Supplementary Service) – Department Calling (PLT No Called Extension)</b> Turn Off or On an extension user ability to call a Department Group Pilot.	0 = Off 1 = On	COS 1 ~ 15 = 1			✓
20-13-15	<b>Class of Service Options (Supplementary Service) – Barge-In, Initiate</b> Turn Off or On an extension user ability to Barge-in on other's calls.	0 = Off 1 = On	COS 1 ~ 15 = 0			✓
20-13-16	<b>Class of Service Options (Supplementary Service) – Barge-In, Receive</b> Turn Off or On Barge-In at the receiving extension (i.e., Barge-In receive).	0 = Off 1 = On	COS 1 ~ 15 = 0			✓
20-13-17	<b>Class of Service Options (Supplementary Service) – Barge-In Tone/Display (Intrusion Tone)</b> Turn Off or On the Barge-In (Intrusion) Tone. If disabled, this also turns off the Barge-In display at the called extension.	0 = Off 1 = On	COS 1 ~ 15 = 1			✓
20-13-18	<b>Class of Service Options (Supplementary Service) – Programmable Function Key Programming (General Level)</b> Turn Off or On an extension user ability to program General function keys using Service Code 751 (by default). (Refer to Program 20-07-10 for Service Code 752.)	0 = Off 1 = On	COS 1 ~ 15 = 1			✓
20-13-19	<b>Class of Service Options (Supplementary Service) – Selectable Display Messaging (Text Messaging)</b> Turn Off or On an extension user ability to use Selectable Display Messaging.	0 = Off 1 = On	COS 1 ~ 15 = 1			✓
20-13-20	<b>Class of Service Options (Supplementary Service) – Account Code/Toll Restriction Operator Alert (Restricted Operation Transfer)</b> Turn Off or On operator alert when an extension improperly enters an Account Code or violates Toll Restriction.	0 = Off 1 = On	COS 1 ~ 15 = 0			✓

Program Number	Program Name/Description	Input Data	Default	Level		
				1	2	3
20-13-21	<b>Class of Service Options (Supplementary Service) – Extension Name</b> Turn Off or On an extension user ability to program the name.	0 = Off 1 = On	COS 1 ~ 15 = 1			✓
20-13-22	<b>Class of Service Options (Supplementary Service) – Busy Status Display (Called Party Status)</b> Turn Off or On the ability to display the detail state of called party.	0 = Off 1 = On	COS 1 ~ 15 = 0			✓
20-13-23	<b>Class of Service Options (Supplementary Service) – Display the Reason for Transfer</b> Select whether or not an extension user should display the reason a call is being transferred to their extension (Call Forward Busy, Call Forward No Answer, DND).	0 = Off 1 = On	COS 1 ~ 15 = 0			✓
20-13-24	<b>Class of Service Options (Supplementary Service) – Privacy Release by Pressing Line Key</b> Turn Off or On an extension user ability to press a line key to barge into an outside call. The Barge-In feature must be enabled if this option is to be used.	0 = Off 1 = On	COS 1 ~ 15 = 0			✓
20-13-26	<b>Class of Service Options (Supplementary Service) – Group Listen</b> Turn Off or On an extension user ability to use Group Listen.	0 = Off 1 = On	COS 1 ~ 15 = 1			✓
20-13-27	<b>Class of Service Options (Supplementary Service) – Busy on Seizing Virtual Extension</b> If set to 1, a busy extension can be called, while someone is talking on a virtual extension key. Program 20-13-06 (Call Waiting) must be set to off for this option to work.	0 = Off 1 = On	COS 1 ~ 15 = 1			✓
20-13-28	<b>Class of Service Options (Supplementary Service) – Allow Class of Service to be Changed</b> Turn Off or On the ability of an extension COS to be changed via Service Code 677.	0 = Off 1 = On	COS 1 ~ 15 = 0			✓
20-13-29	<b>Class of Service Options (Supplementary Service) – Paging Display</b> Turn Off or On an extension user ability to display paging information.	0 = Off 1 = On	COS 1 ~ 15 = 1			✓
20-13-30	<b>Class of Service Options (Supplementary Service) – Background Music</b> Allow/Deny an extension user from turning Background Music on and off.	0 = Allow 1 = Deny	COS 1 ~ 15 = 1			✓

Program Number	Program Name/Description	Input Data	Default	Level		
				1	2	3
20-13-31	<b>Class of Service Options (Supplementary Service) – Connected Line Identification (COLP)</b> Define the supplementary feature availability for each extension Class of Service (COS).	0 = Off 1 = On	COS 1 ~ 15 = 0			✓
20-13-32	<b>Class of Service Options (Supplementary Service) – Deny Multiple Barge-Ins</b> Allow (1)/Deny (0) the extension user ability to have multiple users Barge-In to their conversation.	0 = Off 1 = On	COS 1 ~ 15 = 0			✓
20-13-33	<b>Class of Service Options (Supplementary Service) – Supervisor’s Position Enhancement</b> This option must be On for the operator to use service codes in Program 11-13-10 through Program 11-13-13.	0 = Off 1 = On	COS 1 ~ 15 = 0			✓
20-13-34	<b>Class of Service Options (Supplementary Service) – Block Manual Off-Hook Signaling</b> Turn Off or On an extension user ability to block off-hook signals manually sent from a co-worker.	0 = Off 1 = On	COS 1 ~ 15 = 0			✓
20-13-35	<b>Class of Service Options (Supplementary Service) – Block Camp-On</b> Turn Off or On an extension user ability to block callers from dialing to camp-on.	0 = Off 1 = On	COS 1 ~ 15 = 0			✓
20-13-36	<b>Class of Service Options (Supplementary Service) – Call Duration Timer Display</b> Turn Off or On a Call Timer for the extension.	0 = Off 1 = On	COS 1 ~ 15 = 1			✓
20-13-38	<b>Class of Service Options (Supplementary Service) – Headset Ringing for SLT</b> Turn Off or On an extension user ability to use the Headset ringing.	0 = Off 1 = On	COS 1 ~ 15 = 0			✓
20-13-39	<b>Class of Service Options (Supplementary Service) – Queue Status Display</b> Turn Off or On the Queue Status Display for an extension Class of Service. Any extension with this option enabled also hears the queue alarm.	0 = Off 1 = On	COS 1 ~ 15 = 0			✓
20-13-40	<b>Class of Service Options (Supplementary Service) – Do Not Disturb</b> Turn Off or On an extension user ability to set or cancel Do Not Disturb.	0 = Off 1 = On	COS 1 ~ 15 = 1			✓
20-13-41	<b>Class of Service Options (Supplementary Service) – Voice Mail Message Indication on DSS</b> Turn Off or On the Voice Mail Message Indication for an extension on a DSS console.	0 = Off 1 = On	COS 1 ~ 15 = 0			✓

Program Number	Program Name/Description	Input Data	Default	Level		
				1	2	3
20-13-42	<b>Class of Service Options (Supplementary Service) – Extension Data Swap Enabling</b> Turn Off or On an extension user ability to use the Station Relocation feature.	0 = Off 1 = On	COS 1 ~ 15 = 1			✓
20-13-44	<b>Class of Service Options (Supplementary Service) – Live Monitor Enabling</b> Turn Off or On an extension user ability to use Live Monitor.	0 = Off 1 = On	COS 1 ~ 15 = 1			✓
20-13-45	<b>Class of Service Options (Supplementary Service) – MIC Key Mode While Call Monitoring</b> Set per class of service, when in Call Monitoring Mode determines if the monitored parties receives the barge in alert tone when Coaching Mode is enabled.	0 = Off 1 = On	COS 1 ~ 15 = 1			✓
20-13-47	<b>Class of Service Options (Supplementary Service) – Station Number Display</b> Determine if a station Number is displayed (On) or not displayed (Off) in the LCD when the phone is idle.	0 = Off 1 = On	COS 1 ~ 15 = 1			✓
20-13-48	<b>Class of Service Options (Supplementary Service) – Station Name Display</b> Determine if a station Name is displayed (On) or not displayed (Off) in the LCD when the phone is idle.	0 = Off 1 = On	COS 1 ~ 15 = 1			✓
20-13-49	<b>Class of Service Options (Supplementary Service) – BLF Indication on CO Incoming State</b> Determine if a BLF of the station lights when a Normal CO call is ringing the phone.	0 = Off 1 = On	COS 1 ~ 15 = 0			✓
20-13-50	<b>Class of Service Options (Supplementary Service) – AIC Agent Display which Call is From</b> Determine if the station logged in via AIC codes shows which queue the call is coming from.	0 = Off 1 = On	COS 1 ~ 15 = 1			✓
20-13-51	<b>Class of Service Options (Supplementary Service) – Number and Name Appear in the Directory</b> Determine if an extension name and number are listed (On) or unlisted (Off) in the directory.	0 = Off 1 = On	COS 1 ~ 15 = 1			✓

## Operation

### To set up and program the Cordless DECT Terminals (DTL-8R-1 or DTZ-8R-1):

1. Press and hold down \* and #, then press **TALK**. The F1 LED flashes red and F1=LK01 is displayed on the LCD.



2. Press **Ring/Vol** repeatedly to scroll through the line key (LK) and feature options for function key **F1**.
3. Press **On/Off MUTE** to select the displayed line key or feature.
4. When a Line key is assigned, press **MUTE** once to enter the Off-Hook Ringing ON or OFF Mode. Press **Ring/Vol** to toggle between TALK for On or NO TALK for Off.
  - ◇ *TALK is selected when the F1~F8 function keys are programmed for CO or Call Appearance Keys. NO TALK is selected when F1~F8 function keys are programmed for functions not requiring an off-hook state (e.g., Log On/Off or DND.)*
5. Press **On/Off MUTE** to advance to the next function key (F2 ~ F8).
6. After programming F4, press **On/Off MUTE** to advance to Global Off-Hook Ringing Assignment.
7. Press **Ring/Vol** to turn Global Off-Hook Ringing On or Off (LCD indicates ON or OFF as appropriate).
8. Press **TALK** to exit.
  - ◇ *Function keys F1 ~ F8 can be programmed as Line Keys 1~16, Redial (LNR/SPD), Answer (ANS), Feature (FNC), or Recall. When assigned, these keys operate the same as on an NEC multiline terminal.*
  - ◇ *When initially installed, function keys F1~F8 default to Line keys 1~8 respectively and Off-Hook Ringing defaults to ON.*
  - ◇ *Global Off-Hook Ringing must be ON (default) for any function key to operate with off-hook ringing.*

### Switching Between the Desktop Multiline Telephone and the Cordless DECT Terminals Using the Base Unit:

When the Cordless DECT Terminals is associated with a multiline telephone the following is applicable:

- Switching between the cordless mode and desk mode must be done while both telephones are idle.
- A call in progress cannot be switched between the Cordless DECT Terminals and the associated multiline telephone.
- Switching held calls between the Cordless DECT Terminals and the associated multiline telephone is not recommended because line key LED indications are not provided.

## Cordless Telephone Connection

### Description

When using an APR-L for DTL telephones a cordless telephone (2500-type) can be connected to a multiline terminal.

The GCD-4LCA with GPZ-4LCA Daughter Board, GCD-8LCA with GPZ-8LCE Daughter Board also support cordless telephones, but this feature refers to multiline terminal cordless connection.

### Conditions

- A voice announced internal call to the multiline terminal does not ring the cordless telephone.
- Only one cordless single line telephone can be connected to an APR-L Unit.
- When CO Prime Line is assigned to the associated multiline terminal, internal dial tone cannot be transferred to the cordless telephone.
- The cordless telephone requires a PBR circuit while dialing. When all PBR circuits are busy, a busy tone is heard when the phone goes off-hook.
- Depending on your environment, the maximum number of cordless devices used without interference varies.
- This feature works with 2500-type cordless single line telephones.
- The multiline terminal user and the associated cordless telephone user cannot talk to each other.
- An APR-L Unit with hookflash enabled follows the same operating procedures as a single line terminal connected to a GCD-4LCA with GPZ-4LCA Daughter Board or GCD-8LCA with GPZ-8LCE Daughter Board.
- The multiline terminal LCD displays normal information for multiline terminal when a cordless terminal is used.
- When the multiline terminal user goes off-hook before the cordless single line telephone user, a PBR circuit is not connected for the cordless single line telephone.
- The cordless telephone must be installed within 10 feet of the APR-L Unit.
- The following features are supported by an APR-L:
  - Initiate conference
  - Change station name
  - Privacy release by pressing line key
  - Group Listen

- DSS/BLF indication
- Headset Ringing
- The APR-L only support DTMF signaling, DP (Dial Pulse) is not supported.

### Default Settings

None

## System Availability

### Terminals

- Any DTL terminal with an APR-L Unit except the DTL-2DT-1 TEL

### Required Component(s)

2500-type cordless Single Line Telephone

## Related Features

- ↪ **Ancillary Device Connection**
- ↪ **Class of Service**

## Guide to Feature Programming

The **Level 1**, **Level 2** and **Level 3** columns indicate the programs that are assigned when programming this feature in the order they are most commonly used. These levels are used with PCPro and WebPro wizards for feature programming.

- Level 1 – these are the most commonly assigned programs for this feature.
- Level 2 – these are the next most commonly assigned programs for this feature.
- Level 3 – these programs are not often assigned and require an expert level working knowledge of the system to be properly assigned.

◇ *The items highlighted in gray are read only and cannot be changed.*

Program Number	Program Name/Description	Input Data	Default	Level		
				1	2	3
10-03-01	<b>ETU Setup (DLCA PKG Setup) – Terminal Type (B1)</b> Setup and confirm the Basic Configuration data for terminal type (B1).	0 = Not set 1 = Multiline Terminal 3 = Bluetooth Cordless Handset 6 = PGD (Paging) 7 = PGD (Tone Ringer) 8 = PGD (Doorbox) 9 = PGD (ACI) 10 = DSS Console 11 = -- Not Used --	0		✓	
10-03-02	<b>ETU Setup (DLCA PKG Setup) – Logical Port Number (B1)</b> Use to setup and confirm the Basic Configuration data for logical port number (B1).	0 = Not set 1 = Multiline Terminal (1 ~ 960) 6 = PGD(2)-U10 ADP (Paging) (1 ~ 8) 7 = PGD(2)-U10 ADP (for Tone Ringer) (1 ~ 8) 8 = PGD(2)-U10 ADP (for Door Box) (1 ~ 8) 9 = PGD(2)-U10 ADP (for ACI) (1 ~ 96) 10 = DSS (1 ~ 32) 11 = -- Not Used --	0		✓	
10-03-05	<b>ETU Setup (DLCA PKG Setup) – Optional Installed Unit 2</b> Use to setup and confirm the Basic Configuration data for optional installed Unit 2.	0 = None 1 = APR Module 2 = APA Module 3 = ADA Module 4 = CTA/CTU Module	0		✓	
10-03-06	<b>ETU Setup (DLCA PKG Setup) – Terminal Type (B2)</b> Setup and confirm the Basic Configuration data for terminal type.	0 = Not set 6 = PGD(2)-U10 ADP (Paging) 7 = PGD(2)-U10 ADP (Tone Ringer) 8 = PGD(2)-U10 ADP (Door Box) 9 = PGD(2)-U10 ADP (ACI) 12 = APR (B2 Mode)	0		✓	
10-03-07	<b>ETU Setup (DLCA PKG Setup) – Logical Port Number (B2)</b> Use to setup and confirm the Basic Configuration data for logical port number (B2).	0 = Not Set 6 = PGD(2)-U10 ADP (Ext. Speaker) 7 = PGD(2)-U10 ADP (Paging/Tone Ringer = 1 ~ 8) 8 = PGD(2)-U10 ADP (for Door Box = 1 ~ 8) (ACI) = (1 ~ 96) 9 = PGD(2)-U10 ADP 12 = APR (for B2 Mode) (193 ~ 960)	0		✓	

Program Number	Program Name/Description	Input Data	Default	Level		
				1	2	3
10-03-08	<b>ETU Setup (DLCA PKG Setup) – Multiline Telephone Type</b> Read only program that shows the type of multiline terminal connected to the port.	0 = DT3** 1 = Dterm8 2 = Dterm7	0		✓	
10-03-09	<b>ETU Setup (DLCA PKG Setup) – Side Option Information</b> Read only command that shows the type of side module connected to the terminal.	0 = No Option 1 = 8LK Unit 2 = 16LK Unit 3 = 24ADM	0		✓	
10-03-10	<b>ETU Setup (DLCA PKG Setup) – Bottom Option Information (Only applies to DTL style telephones)</b> Shows optional adapter information.	0 = No option 1 = APR 2 = ADA 3 = BHA	0		✓	
10-03-11	<b>ETU Setup (DLCA PKG Setup) – Handset Option Information</b> Shows optional adapter information.	0 = No option 1 = PSA/PSD 2 = Bluetooth Cordless Handset	0		✓	
15-07-01	<b>Programmable Function Keys</b> Assign functions to multiline terminal line keys.	Line Key 1 ~ 48 0 ~ 99 (Normal Function Code 751 by default) *00 ~ *99 (Appearance Function Code) (Service Code 752 by default)	Refer to the Programming Manual for default values.		✓	
20-07-02	<b>Class of Service Options (Administrator Level) – Changing the Music on Hold Tone</b> Turn Off or On an extension user ability to change the Music on Hold tone.	0 = Off 1 = On	COS 1 ~ 14 = 0 COS 15 = 1		✓	
20-07-03	<b>Class of Service Options (Administrator Level) – Time Setting</b> Turn Off or On an extension user ability to set the Time via Service Code 728.	0 = Off 1 = On	COS 1 ~ 15 = 1		✓	
20-07-04	<b>Class of Service Options (Administrator Level) – Storing Speed Dialing Entries</b> Turn Off or On an extension to store System or Group Speed Dialing numbers.	0 = Off 1 = On	COS 1 ~ 15 = 1		✓	
20-07-05	<b>Class of Service Options (Administrator Level) – Set/Cancel Automatic Trunk-to-Trunk Transfer</b> Turn Off or On an extension user ability to use the Trunk-to-Trunk Forwarding service codes.	0 = Off 1 = On	COS 1 ~ 15 = 0		✓	
20-07-10	<b>Class of Service Options (Administrator Level) – Programmable Function Key Programming (Appearance Level)</b> Turn Off or On an extension user ability to program the Appearance function keys using Service Code 752.	0 = Off 1 = On	COS 1 ~ 15 = 1		✓	

Program Number	Program Name/Description	Input Data	Default	Level		
				1	2	3
20-07-11	<b>Class of Service Options (Administrator Level) – Forced Trunk Disconnect (analog trunk only)</b> Turn Off or On an extension to use Forced Trunk Disconnect. This allows the extension to disconnect an Unsupervised Conference in progress.	0 = Off 1 = On	COS 1 ~ 14 = 0 COS 15 = 1		✓	
20-07-12	<b>Class of Service Options (Administrator Level) – Trunk Port Disable</b> Turn Off or On the extension ability to use the Trunk Port Disable feature.	0 = Off 1 = On	COS 1 ~ 14 = 0 COS 15 = 1		✓	
20-07-13	<b>Class of Service Options (Administrator Level) – VRS Record (VRS Msg Operation)</b> Turn Off or On an extension user ability to record, erase and listen to VRS messages.	0 = Off 1 = On	COS 1 ~ 14 = 0 COS 15 = 1		✓	
20-07-14	<b>Class of Service Options (Administrator Level) – VRS General Message Play</b> Turn Off or On an extension user ability to dial 4 or Service Code 611 to listen to the General Message.	0 = Off 1 = On	COS 1 ~ 14 = 0 COS 15 = 1		✓	
20-07-15	<b>Class of Service Options (Administrator Level) – VRS General Message Record/ Delete</b> Turn Off or On an extension user ability to dial Service Code 612 and record, listen to, or erase the General Message.	0 = Off 1 = On	COS 1 ~ 14 = 0 COS 15 = 1		✓	
20-07-18	<b>Class of Service Options (Administrator Level) – SMDR Printout Accumulated Extension Data</b> Define if Accumulated Extension Data is included in the SMDR Printout for each Class of Service.	0 = Off 1 = On	COS 1 ~ 14 = 0 COS 15 = 1		✓	
20-07-19	<b>Class of Service Options (Administrator Level) – SMDR Printout Department Group (STG) Data</b> Define if Department Group (STG) Data is included in the SMDR Printout for each Class of Service.	0 = Off 1 = On	COS 1 ~ 14 = 0 COS 15 = 1		✓	
20-07-20	<b>Class of Service Options (Administrator Level) – SMDR Printout Accumulated Account Code Data</b> Define if Accumulated Account Code Data is included in the SMDR Printout for each Class of Service.	0 = Off 1 = On	COS 1 ~ 14 = 0 COS 15 = 1		✓	
20-07-24	<b>Class of Service Options (Administrator Level) – Set/Cancel Private Call Refuse</b> Enable/Disable an extension user ability to set or cancel Private Call Refuse.	0 = Off 1 = On	COS 1 ~ 15 = 0		✓	

Program Number	Program Name/Description	Input Data	Default	Level		
				1	2	3
20-07-25	<b>Class of Service Options (Administrator Level) – Set/Cancel Caller ID Refuse</b> Enable/Disable an extension user ability to set or cancel Caller ID Refuse.	0 = Off 1 = On	COS 1 ~ 15 = 0		✓	
20-07-26	<b>Class of Service Options (Administrator Level) – Dial-In Mode Switch</b> Enable/Disable an extension user ability to set or cancel dial-in mode switch.	0 = Off 1 = On	COS 1 ~ 15 = 0		✓	
20-07-27	<b>Class of Service Options (Administrator Level) – Do-Not-Call Administrator</b> Enable/Disable an extension user ability to set or cancel do not call administrator.	0 = Off 1 = On	COS 1 ~ 15 = 0		✓	
20-08-01	<b>Class of Service Options (Outgoing Call Service) – Intercom Calls</b> Turn Off or On Intercom calling for the extension.	0 = Off 1 = On	COS 1 ~ 15 = 1		✓	
20-08-02	<b>Class of Service Options (Outgoing Call Service) – Trunk Outgoing Calls</b> Turn Off or On outgoing trunk calling for the extension.	0 = Off 1 = On	COS 1 ~ 15 = 1		✓	
20-08-03	<b>Class of Service Options (Outgoing Call Service) – System Speed Dialing</b> Turn Off or On an extension user ability to make outbound calls using system speed dial numbers.	0 = Off 1 = On	COS 1 ~ 15 = 1		✓	
20-08-04	<b>Class of Service Options (Outgoing Call Service) – Group Speed Dialing</b> Turn Off or On an extension user ability to make outbound calls using group speed dial numbers.	0 = Off 1 = On	COS 1 ~ 15 = 1		✓	
20-08-06	<b>Class of Service Options (Outgoing Call Service) – Toll Restriction Override</b> Turn Off or On Toll Restricting Override (Service Code 663).	0 = Off 1 = On	COS 1 ~ 15 = 0		✓	
20-08-08	<b>Class of Service Options (Outgoing Call Service) – Toll Restriction Dial Block</b> Turn Off or On an extension ability to use Dial Block.	0 = Off 1 = On	COS 1 ~ 15 = 0		✓	
20-08-10	<b>Class of Service Options (Outgoing Call Service) – Signal/Voice Call</b> Turn Off or On an extension allowing it to force Handsfree Answerback or Forced Intercom Ringing for outgoing Intercom calls.	0 = Off 1 = On	COS 1 ~ 15 = 1		✓	

Program Number	Program Name/Description	Input Data	Default	Level		
				1	2	3
20-08-11	<p><b>Class of Service Options (Outgoing Call Service) – Protect for the Call Mode Switching from Caller</b></p> <p>When an extension is set to ring mode for ICM calls, enabling this option prevents callers from changing the call to voice announce mode.</p>	0 = Off 1 = On	COS 1 ~ 15 = 0		✓	
20-08-12	<p><b>Class of Service Options (Outgoing Call Service) – Department Group Step Calling</b></p> <p>Turn Off or On an extension user ability to use Department Group Step Calling.</p>	0 = Off 1 = On	COS 1 ~ 15 = 1		✓	
20-08-13	<p><b>Class of Service Options (Outgoing Call Service) – ISDN CLIP</b></p> <p>Determine if the ISDN calling line identity presentation and screening indicators are to be allowed.</p>	0 = Off 1 = On	COS 1 ~ 15 = 0		✓	
20-08-14	<p><b>Class of Service Options (Outgoing Call Service) – Call Address Information</b></p> <p>Enable/Disable Call Address Information for each Class Of Service.</p>	0 = Off 1 = On	COS 1 ~ 15 = 0		✓	
20-08-15	<p><b>Class of Service Options (Outgoing Call Service) – Block Outgoing Caller ID</b></p> <p>Turn Off or On a user Class of Service from automatically blocking outgoing Caller ID information when a call is placed. If block is enabled, the system automatically inserts the Caller ID block code *67 (defined in Program 14-01-21) before the user dialed digits (this requires Program 14-02-10 to be enabled). If block is disabled, the system outdials the call just as it was dialed by the user.</p>	0 = Off 1 = On	COS 1 ~ 15 = 0		✓	
20-08-16	<p><b>Class of Service Options (Outgoing Call Service) – Display E911 Dialed Extension Name and Number</b></p> <p>Turn Off or On an extension ability to display the name and number of the extension that dialed 911.</p>	0 = Off 1 = On	COS 1 ~ 15 = 0		✓	
20-08-17	<p><b>Class of Service Options (Outgoing Call Service) – ARS Override of Trunk Access Map</b></p> <p>Turn Off or On an extension user ability to override the trunk access map programming for outgoing calls.</p>	0 = Off 1 = On	COS 1 ~ 15 = 0		✓	
20-08-22	<p><b>Class of Service Options (Outgoing Call Service) – Voice Over to busy Virtual Extension</b></p> <p>Enable/Disable an extension ability to voice over to a busy virtual extension.</p>	0 = Off 1 = On	COS 1 ~ 15 = 0		✓	



Program Number	Program Name/Description	Input Data	Default	Level		
				1	2	3
20-09-01	<p><b>Class of Service Options (Incoming Call Service) – Second Call for DID/DISA/DIL/E&amp;M Override</b></p> <p>Turns Off or On the extension ability to receive a second call from a DID, DISA, DIL, or tie line caller.</p> <p>➡ <i>With this option set to 1, the destination extension must be busy for a second DNIS caller to ring through. If the destination extension does not have a trunk or CAP key available for the second call and a previous call is ringing the extension but has not yet been answered, the second caller hears busy regardless of this program setting.</i></p>	0 = Off 1 = On	COS 1 ~ 15 = 1		✓	
20-09-05	<p><b>Class of Service Options (Incoming Call Service) – Signal/Voice Call</b></p> <p>Turn Off or On an extension user ability to enable Handsfree Answerback or Forced Intercom Ringing for their incoming Intercom calls.</p>	0 = Off 1 = On	COS 1 ~ 15 = 1		✓	
20-09-08	<p><b>Class of Service Options (Incoming Call Service) – Calling Party Information</b></p> <p>Turn Off or On and extension ability to display calling party information on CCIS calls.</p>	0 = Off 1 = On	COS 1 ~ 15 = 1		✓	
20-10-01	<p><b>Class of Service Options (Answer Service) – Group Call Pickup (Within Group)</b></p> <p>Turn Off or On Group Call Pickup for calls ringing an extension Pickup Group as well as ring group calls (Service Code *#).</p>	0 = Off 1 = On	COS 1 ~ 15 = 1		✓	
20-10-02	<p><b>Class of Service Options (Answer Service) – Group Call Pickup (Another Group)</b></p> <p>Turn Off or On Group Call Pickup for calls ringing outside a group (Service Code 769).</p>	0 = Off 1 = On	COS 1 ~ 15 = 1		✓	
20-10-03	<p><b>Class of Service Options (Answer Service) – Group Call Pickup for Specific Group</b></p> <p>Turn Off or On Group Call Pickup for a specific group using service code 768.</p>	0 = Off 1 = On	COS 1 ~ 15 = 1		✓	
20-10-04	<p><b>Class of Service Options (Answer Service) – Telephone Call Pickup</b></p> <p>Enable or Disable the group call pickup.</p>	0 = Off 1 = On	COS 1 ~ 15 = 1		✓	
20-10-05	<p><b>Class of Service Options (Answer Service) – Directed Call Pickup for Own Group</b></p> <p>Turn Off or On Directed Call Pickup for calls ringing an extension Pickup Group (Service Code 756).</p>	0 = Off 1 = On	COS 1 ~ 15 = 1		✓	
20-10-06	<p><b>Class of Service Options (Answer Service) – Meet-Me Conference and Paging</b></p> <p>Turns Off or On an extension to use Meet-Me Conference and Paging.</p>	0 = Off 1 = On	COS 1 ~ 15 = 1		✓	

Program Number	Program Name/Description	Input Data	Default	Level		
				1	2	3
20-10-07	<b>Class of Service Options (Answer Service) – Automatic Off-Hook Answer</b> Turns Off or On an extension to use Universal Auto Answer (no service code required).	0 = Off 1 = On	COS 1 ~ 15 = 0		✓	
20-10-08	<b>Class of Service Options (Answer Service) – Virtual Extension Off-Hook Answer</b> Turns Off or On an extension ability to answer an incoming call on a Call Arrival (CAR)/ Secondary Incoming Extension (SIE)/ Virtual Extension simply by lifting the handset.	0 = Off 1 = On	COS 1 ~ 15 = 1		✓	
20-10-09	<b>Class of Service Options (Answer Service) – Call Pickup Callback</b> Turn off or on an extension ability to use Call Pickup to Pick up Callback calls.	0 = Off 1 = On	COS 1 ~ 15 = 1		✓	
20-11-01	<b>Class of Service Options (Hold/Transfer Service) – Call Forward All</b> Turn Off or On an extension user ability to set Call Forward Immediate.	0 = Off 1 = On	COS 1 ~ 15 = 1		✓	
20-11-02	<b>Class of Service Options (Hold/Transfer Service) – Call Forward When Busy</b> Turn Off or On an extension user ability to set Call Forwarding when Busy.	0 = Off 1 = On	COS 1 ~ 15 = 1		✓	
20-11-03	<b>Class of Service Options (Hold/Transfer Service) – Call Forwarding When Unanswered</b> Turn Off or On an extension user ability to set Call Forwarding when Unanswered.	0 = Off 1 = On	COS 1 ~ 15 = 1		✓	
20-11-04	<b>Class of Service Options (Hold/Transfer Service) – Call Forwarding (Both Ringing)</b> Turn Off or On an extension user ability to set Call Forwarding with Both Ringing.	0 = Off 1 = On	COS 1 ~ 15 = 1		✓	
20-11-05	<b>Class of Service Options (Hold/Transfer Service) – Call Forwarding with Follow Me</b> Turn Off or On an extension user ability to set Call Forward with Follow Me.	0 = Off 1 = On	COS 1 ~ 15 = 1		✓	
20-11-06	<b>Class of Service Options (Hold/Transfer Service) – Unscreened Transfer (Ring Inward Transfer)</b> Turn Off or On an extension ability to use Unscreened Transfer.	0 = Off 1 = On	COS 1 ~ 15 = 1		✓	
20-11-09	<b>Class of Service Options (Hold/Transfer Service) – Group Hold Initiate</b> Turn Off or On an extension user ability to initiate a Group Hold.	0 = Off 1 = On	COS 1 ~ 15 = 1		✓	
20-11-10	<b>Class of Service Options (Hold/Transfer Service) – Group Hold Answer</b> Turn Off or On an extension user ability to pick up a call on Group Hold.	0 = Off 1 = On	COS 1 ~ 15 = 1		✓	

Program Number	Program Name/Description	Input Data	Default	Level		
				1	2	3
20-11-12	<b>Class of Service Options (Hold/Transfer Service) – Call Forwarding Off-Premise (External Call Forwarding)</b> Turn Off or On setting up Call Forwarding Off-Premise at the extension.	0 = Off 1 = On	COS 1 ~ 15 = 0		✓	
20-11-13	<b>Class of Service Options (Hold/Transfer Service) – Operator Transfer After Hold Callback</b> Turn Off or On an extension ability to have a call which recalls from hold transfer to the operator.	0 = Off 1 = On	COS 1 ~ 15 = 0		✓	
20-11-14	<b>Class of Service Options (Hold/Transfer Service) – Trunk-to-Trunk Transfer Restriction</b> Turn Off or On the Trunk-to-Trunk Transfer Restriction. If enabled, Trunk-to-Trunk Transfer is not possible.	0 = Off 1 = On	COS 1 ~ 15 = 0		✓	
20-11-15	<b>Class of Service Options (Hold/Transfer Service) – VRS Personal Greeting (Message Greeting)</b> Turn Off or On an extension user ability to dial Service Code 616 to record, listen to or erase the Personal Greeting Message.	0 = Off 1 = On	COS 1 ~ 15 = 1		✓	
20-11-16	<b>Class of Service Options (Hold/Transfer Service) – Call Redirect</b> Turn Off or On an extension user ability to transfer a call to a predefined destination (such as an operator, voice mail, or another extension) without answering the call.	0 = Off 1 = On	COS 1 ~ 15 = 1		✓	
20-11-17	<b>Class of Service Options (Hold/Transfer Service) – Department Group Trunk-to-Trunk Transfer (Each Telephone Group Transfer)</b> Turn Off or On an extension user in a Department Group ability to use the Trunk-to-Trunk Forwarding service codes.	0 = Off 1 = On	COS 1 ~ 15 = 1		✓	
20-11-18	<b>Class of Service Options (Hold/Transfer Service) – No Recall</b> Allow (0)/Deny (1) answered Transferred calls from recalling the originating extension.	0 = Off 1 = On	COS 1 ~ 15 = 0		✓	
20-11-19	<b>Class of Service Options (Hold/Transfer Service) – Hold/Extended Park</b> Determine whether an extension Class of Service should allow normal (0) or extended Park (1).	0 = Off 1 = On	COS 1 ~ 15 = 0		✓	
20-11-20	<b>Class of Service Options (Hold/Transfer Service) – No Callback</b> Turn Off or On an extension ability to receive Callbacks.	0 = Off 1 = On	COS 1 ~ 15 = 0		✓	

Program Number	Program Name/Description	Input Data	Default	Level		
				1	2	3
20-11-21	<b>Class of Service Options (Hold/Transfer Service) – Restriction for Tandem Trunking on Hang Up</b> Allow/Deny an extension user ability to set up a tandem/conference call automatically when they hang up.	0 = Off 1 = On	COS 1 ~ 15 = 0		✓	
20-11-23	<b>Class of Service Options (Hold/Transfer Service) – CAR/VE Call Forward Set/Cancel</b> Turn Off or On an extension user ability to set and cancel Call Forwarding for a CAR or Virtual Extension.	0 = Off 1 = On	COS 1 ~ 15 = 1		✓	
20-11-24	<b>Class of Service Options (Hold/Transfer Service) – Trunk Park Hold Mode</b> Set the hold type when a trunk call is put on hold by an extension.	0 = Non Exclusive Hold (Off) 1 = Exclusive Hold (On)	COS 1 ~ 15 = 1		✓	
20-11-25	<b>Class of Service Options (Hold/Transfer Service) – Transfer Park Call</b> Turn Off or On an extension user ability to transfer a parked call.	0 = Off 1 = On	COS 1 ~ 15 = 1		✓	
20-12-03	<b>Class of Service Options (Charging Cost Service) – Cost Display (TTU)</b> ISDN billing information.	0 = Off 1 = On	COS 1 ~ 15 = 1		✓	
20-13-01	<b>Class of Service Options (Supplementary Service) – Long Conversation Alarm</b> Turn Off or On the Warning Tone for Long Conversation (not for single line telephones).	0 = Off 1 = On	COS 1 ~ 15 = 0		✓	
20-13-02	<b>Class of Service Options (Supplementary Service) – Long Conversation Cutoff (Incoming)</b> Turn Off or On an extension user ability to use Long Conversation Cutoff for incoming calls.	0 = Off 1 = On	COS 1 ~ 15 = 0		✓	
20-13-03	<b>Class of Service Options (Supplementary Service) – Long Conversation Cutoff (Outgoing)</b> Turn Off or On an extension user ability to use Long Conversation Cutoff for outgoing calls.	0 = Off 1 = On	COS 1 ~ 15 = 0		✓	
20-13-04	<b>Class of Service Options (Supplementary Service) – Call Forward/DND Override (Bypass Call)</b> Turn On or Off the ability to use Call Forwarding/DND Override.	0 = Off 1 = On	COS 1 ~ 15 = 1		✓	
20-13-05	<b>Class of Service Options (Supplementary Service) – Intercom Off-Hook Signaling</b> Turn Off or On the ability of an extension to send off-hook signals. ➡ This setting functions with Programs 20-09-07 and 20-13-06 disabled.	0 = Off 1 = On	COS 1 ~ 15 = 1		✓	

Program Number	Program Name/Description	Input Data	Default	Level		
				1	2	3
20-13-06	<p><b>Class of Service Options (Supplementary Service) – Automatic Off-Hook Signaling (Automatic Override)</b></p> <p>Allow a busy extension user to Manually (0) or Automatically (1) receive off-hook signals.</p> <p>➤ <i>This setting is to receive incoming call signaling information during call queuing.</i></p>	0 = Off 1 = On	COS 1 ~ 15 = 1		✓	
20-13-07	<p><b>Class of Service Options (Supplementary Service) – Message Waiting</b></p> <p>Turn Off or On an extension user ability to leave Message Waiting.</p>	0 = Off 1 = On	COS 1 ~ 15 = 1		✓	
20-13-10	<p><b>Class of Service Options (Supplementary Service) – Barge-In Monitor</b></p> <p>Enable the Barge-In Speech Mode) or Monitor Mode at the initiating extension (i.e., Barge-In initiator).</p>	0 = Off 1 = On	COS 1 ~ 15 = 0		✓	
20-13-11	<p><b>Class of Service Options (Supplementary Service) – Room Monitor, Initiating Extension</b></p> <p>Turn Off or On an extension user ability to Room Monitor other extensions.</p>	0 = Off 1 = On	COS 1 ~ 15 = 0		✓	
20-13-12	<p><b>Class of Service Options (Supplementary Service) – Room Monitor, Extension Being Monitored</b></p> <p>Turn Off or On an extension ability to be monitored by other extensions.</p>	0 = Off 1 = On	COS 1 ~ 15 = 0		✓	
20-13-13	<p><b>Class of Service Options (Supplementary Service) – Continued Dialing (DTMF) Signal on ICM Call</b></p> <p>Turn Off or On an extension user ability to use Continued Dialing, which allows DTMF signal sending while talking on extension.</p>	0 = Off 1 = On	COS 1 ~ 15 = 1		✓	
20-13-14	<p><b>Class of Service Options (Supplementary Service) – Department Calling (PLT No Called Extension)</b></p> <p>Turn Off or On an extension user ability to call a Department Group Pilot.</p>	0 = Off 1 = On	COS 1 ~ 15 = 1		✓	
20-13-15	<p><b>Class of Service Options (Supplementary Service) – Barge-In, Initiate</b></p> <p>Turn Off or On an extension user ability to Barge-in on other's calls.</p>	0 = Off 1 = On	COS 1 ~ 15 = 0		✓	
20-13-16	<p><b>Class of Service Options (Supplementary Service) – Barge-In, Receive</b></p> <p>Turn Off or On Barge-In at the receiving extension (i.e., Barge-In receive).</p>	0 = Off 1 = On	COS 1 ~ 15 = 0		✓	

Program Number	Program Name/Description	Input Data	Default	Level		
				1	2	3
20-13-17	<b>Class of Service Options (Supplementary Service) – Barge-In Tone/Display (Intrusion Tone)</b> Turn Off or On the Barge-In (Intrusion) Tone. If disabled, this also turns off the Barge-In display at the called extension.	0 = Off 1 = On	COS 1 ~ 15 = 1		✓	
20-13-20	<b>Class of Service Options (Supplementary Service) – Account Code/Toll Restriction Operator Alert (Restricted Operation Transfer)</b> Turn Off or On operator alert when an extension improperly enters an Account Code or violates Toll Restriction.	0 = Off 1 = On	COS 1 ~ 15 = 0		✓	
20-13-21	<b>Class of Service Options (Supplementary Service) – Extension Name</b> Turn Off or On an extension user ability to program the name.	0 = Off 1 = On	COS 1 ~ 15 = 1		✓	
20-13-22	<b>Class of Service Options (Supplementary Service) – Busy Status Display (Called Party Status)</b> Turn Off or On the ability to display the detail state of called party.	0 = Off 1 = On	COS 1 ~ 15 = 0		✓	
20-13-23	<b>Class of Service Options (Supplementary Service) – Display the Reason for Transfer</b> Select whether or not an extension user should display the reason a call is being transferred to their extension (Call Forward Busy, Call Forward No Answer, DND).	0 = Off 1 = On	COS 1 ~ 15 = 0		✓	
20-13-24	<b>Class of Service Options (Supplementary Service) – Privacy Release by Pressing Line Key</b> Turn Off or On an extension user ability to press a line key to barge into an outside call. The Barge-In feature must be enabled if this option is to be used.	0 = Off 1 = On	COS 1 ~ 15 = 0		✓	
20-13-26	<b>Class of Service Options (Supplementary Service) – Group Listen</b> Turn Off or On an extension user ability to use Group Listen.	0 = Off 1 = On	COS 1 ~ 15 = 1		✓	
20-13-27	<b>Class of Service Options (Supplementary Service) – Busy on Seizing Virtual Extension</b> If set to 1, a busy extension can be called, while someone is talking on a virtual extension key. Program 20-13-06 (Call Waiting) must be set to off for this option to work.	0 = Off 1 = On	COS 1 ~ 15 = 1		✓	

Program Number	Program Name/Description	Input Data	Default	Level		
				1	2	3
20-13-28	<b>Class of Service Options (Supplementary Service) – Allow Class of Service to be Changed</b> Turn Off or On the ability of an extension COS to be changed via Service Code 677.	0 = Off 1 = On	COS 1 ~ 15 = 0		✓	
20-13-29	<b>Class of Service Options (Supplementary Service) – Paging Display</b> Turn Off or On an extension user ability to display paging information.	0 = Off 1 = On	COS 1 ~ 15 = 1		✓	
20-13-30	<b>Class of Service Options (Supplementary Service) – Background Music</b> Allow/Deny an extension user from turning Background Music on and off.	0 = Allow 1 = Deny	COS 1 ~ 15 = 1		✓	
20-13-31	<b>Class of Service Options (Supplementary Service) – Connected Line Identification (COLP)</b> Define the supplementary feature availability for each extension Class of Service (COS).	0 = Off 1 = On	COS 1 ~ 15 = 0		✓	
20-13-32	<b>Class of Service Options (Supplementary Service) – Deny Multiple Barge-Ins</b> Allow (1)/Deny (0) the extension user ability to have multiple users Barge-In to their conversation.	0 = Off 1 = On	COS 1 ~ 15 = 0		✓	
20-13-33	<b>Class of Service Options (Supplementary Service) – Supervisor’s Position Enhancement</b> This option must be On for the operator to use service codes in Program 11-13-10 through Program 11-13-13.	0 = Off 1 = On	COS 1 ~ 15 = 0		✓	
20-13-34	<b>Class of Service Options (Supplementary Service) – Block Manual Off-Hook Signaling</b> Turn Off or On an extension user ability to block off-hook signals manually sent from a co-worker.	0 = Off 1 = On	COS 1 ~ 15 = 0		✓	
20-13-35	<b>Class of Service Options (Supplementary Service) – Block Camp-On</b> Turn Off or On an extension user ability to block callers from dialing to camp-on.	0 = Off 1 = On	COS 1 ~ 15 = 0		✓	
20-13-39	<b>Class of Service Options (Supplementary Service) – Queue Status Display</b> Turn Off or On the Queue Status Display for an extension Class of Service. Any extension with this option enabled also hears the queue alarm.	0 = Off 1 = On	COS 1 ~ 15 = 0		✓	
20-13-40	<b>Class of Service Options (Supplementary Service) – Do Not Disturb</b> Turn Off or On an extension user ability to set or cancel Do Not Disturb.	0 = Off 1 = On	COS 1 ~ 15 = 1		✓	

Program Number	Program Name/Description	Input Data	Default	Level		
				1	2	3
20-13-42	<b>Class of Service Options (Supplementary Service) – Extension Data Swap Enabling</b> Turn Off or On an extension user ability to use the Station Relocation feature.	0 = Off 1 = On	COS 1 ~ 15 = 1		✓	
20-13-44	<b>Class of Service Options (Supplementary Service) – Live Monitor Enabling</b> Turn Off or On an extension user ability to use Live Monitor.	0 = Off 1 = On	COS 1 ~ 15 = 1		✓	
20-13-48	<b>Class of Service Options (Supplementary Service) – Station Name Display</b> Determine if a station Name is displayed (On) or not displayed (Off) in the LCD when the phone is idle.	0 = Off 1 = On	COS 1 ~ 15 = 1		✓	
20-13-49	<b>Class of Service Options (Supplementary Service) – BLF Indication on CO Incoming State</b> Determine if a BLF of the station lights when a Normal CO call is ringing the phone.	0 = Off 1 = On	COS 1 ~ 15 = 0		✓	
20-13-50	<b>Class of Service Options (Supplementary Service) – AIC Agent Display which Call is From</b> Determine if the station logged in via AIC codes shows which queue the call is coming from.	0 = Off 1 = On	COS 1 ~ 15 = 1		✓	
20-13-51	<b>Class of Service Options (Supplementary Service) – Number and Name Appear in the Directory</b> Determine if an extension name and number are listed (On) or unlisted (Off) in the directory.	0 = Off 1 = On	COS 1 ~ 15 = 1		✓	

## Operation

### To make a call using a cordless single line telephone:

1. Go off-hook.
2. Dial the station number or dial the Trunk Access Code and telephone number.

### To answer a call using a cordless single line telephone:

When the multiline terminal is ringing, the incoming call can be answered by the cordless single line telephone user by going off-hook, when ringing line preference is assigned for the multiline terminal.

### To transfer a call from a cordless single line telephone to its associated multiline terminal:

1. The multiline terminal user goes off-hook.



2. The single line telephone user goes on-hook (at this time, the call is automatically connected to the multiline terminal).

**To transfer a call from a multiline terminal to its associated cordless single line telephone:**

1. The single line telephone user goes off-hook (at this time, the call is automatically connected to the single line telephone).
2. The multiline terminal user goes on-hook.

Refer to [Single Line Telephones, Analog 500/2500 Sets on page 2-1449](#) for hookflash information.

## CO Message Waiting Indication

### Description

This feature provides a Message Waiting indication when Voice Mail from the Central Office is used. The CO provides this feature using Visual Message Waiting Indication (VMWI) standards. Visual Message Waiting Indication alerts a user that a message is present in their voice mail box. When VMWI is provided, the UNIVERGE SV9100 provides a flashing LED on a line key assigned with the trunk appearance.

The VMWI standard supported by the UNIVERGE SV9100 includes:

- Type 1 Caller ID, FSK without power ringing using the MDMF protocol
- Type 1 Caller ID, FSK without power ringing using the SDMF protocol

### Conditions

- When a new message is stored in the CO Voice Mail system, the LED flashes green (0.5 sec ON, 0.5 sec OFF) on the Direct Trunk Appearance line key at stations assigned for this feature.
- When the Direct Trunk Appearance line key is used by other ports during green blink (flutter), the line key becomes in use and LED is turned on red.
- When the station is using a DTL-8LD telephone, <> flashes on the LCD of a Direct Trunk appearance line key to indicate a new message is stored in the CO voice mail system.
- A local Voice Mail system and this feature can be supported in the same system.
- When power outage or some other reason causes the Central Office – Message Waiting Indication (CO-MWI) to be out of synchronization with the system, an Attendant Position can clear the CO-MWI per CO line.
- The CO-MWI Callback Speed Dial number uses System Speed Dial Area.
- This feature is supported at multiline terminals and DSS Consoles assigned with a direct line key appearance of the CO/PBX line key supporting this feature and with proper Class of Service assignment.
- When additional digits (e.g., for password) are included in the CO Message Waiting Indication System Speed Dial buffer, they must be separated by pauses to allow connection to the CO Voice Mail system.
- A Single Line Telephone or Wireless DECT (SIP) Handset cannot indicate the CO-MWI.
- The Message Display Board does not support the CO-MWI.

### Default Settings

None

## System Availability

### Terminals

All Multiline Terminals

### Required Component(s)

GCD-4COTB Blade with GPZ-4COTF Daughter Board

## Related Features

- ↳ **Battery Backup - System Power**
- ↳ **Message Waiting**
- ↳ **Speed Dial – System/Group/Station**
- ↳ **InMail**
- ↳ **Voice Mail Integration (Analog)**

## Guide to Feature Programming

The **Level 1**, **Level 2** and **Level 3** columns indicate the programs that are assigned when programming this feature in the order they are most commonly used. These levels are used with PCPro and WebPro wizards for feature programming.

- Level 1 – these are the most commonly assigned programs for this feature.
- Level 2 – these are the next most commonly assigned programs for this feature.
- Level 3 – these programs are not often assigned and require an expert level working knowledge of the system to be properly assigned.

Program Number	Program Name/Description	Input Data	Default	Level		
				1	2	3
15-17-01	<b>CO Message Waiting Indication – LED Flash Assignment</b>	0 = LED Off 1 = LED On	0	✓		
20-02-08	<b>System Options for Multiline Telephones – LCD Display Holding Time</b>	0 ~ 64800 seconds	5			✓
20-06-01	<b>Class of Service for Extensions</b> Assign a Class of Service (1 ~ 15) to extensions.	Day Night/Mode: 1 ~ 8 Class of Service of Extensions (1 ~ 15)	Extension port 101 = Class 15 All other extension port = Class 1			✓

Program Number	Program Name/Description	Input Data	Default	Level		
				1	2	3
20-07-23	Class of Service Options (Administrator Level) – CO Message Waiting Indication Callback Number Programming	0 = Off 1 = On	COS 01 ~ 15 = 0	✓		
21-22-01	CO Message Waiting Indication – Call Back Settings – CO MWI Call Back Enabling	0 = Disable VMWI Service 1 = Enable VMWI Service	0	✓		
21-22-02	CO Message Waiting Indication – Call Back Settings – CO-MWI Call Back Number Area Setting	0000 ~ 9999	9999	✓		

## Operation

### To program the CO Message Waiting Callback Speed Dial Bin from an Attendant Position:

1. Press **Feature**.
2. Dial **28**.
3. Press the **CO line**.
4. Dial Speed Dial bin (default = 9999).  
 ◇ *The valid range is 0000~9999 and depends on system programming.*
5. Press **Feature**.

### To program the Central Office – Message Waiting Indication callback number from an Attendant Position:

1. Press **Feature**.
2. Dial **29**.
3. Press the **CO line**.
4. Dial the Central Office – Message Waiting Indication callback number.  
 ◇ *The Exit key is used to clear all digits.*
5. Press **Feature**.  
 ◇ *This operation updates data in Program 13-04-01, a user can also edit the dial digits in Program 13-04-01 from handset-programming or PCPro/WebPro.*

### To retrieve a Central Office – Message Waiting Indication:

1. Press **Feature**.
2. Dial **27**.
3. Press the **CO line** key.  
 ◇ *The LCD indicates 'ERROR' if the CO Line is not flashing for a CO Message Waiting.*

4. Listen to the message.
  - ◇ *The operation for deletion is based on the remote voice mail system.*
5. Hang up.

**To clear the Central Office – Message Waiting Indication from an Attendant Position:**

1. Press **Feature**.
2. Dial **20**.
3. Press the **CO line** key.



### Description

Data Line Security protects any station port from receiving audible tones (such as Camp-On or Override) and denies a station from barging in while busy to prevent disruption of data transmission when using a modem or facsimile machine.

### Conditions

- When a multiline terminal and a single line telephone are assigned for Data Line Security, Tone Override/Voice Override and Call Alert notification tone are not heard over the handset speaker.
- Data Line Security protects a station from Barge-In, even when Barge-In is allowed in Class of Service.
- When any multiline terminal or single line telephone calls a station with Data Line Security, a constant busy tone is heard.

### Default Settings

None

### System Availability

#### Terminals

All Terminals

#### Required Component(s)

None

### Related Features

None

## Guide to Feature Programming

The **Level 1**, **Level 2** and **Level 3** columns indicate the programs that are assigned when programming this feature in the order they are most commonly used. These levels are used with PCPro and WebPro wizards for feature programming.

- Level 1 – these are the most commonly assigned programs for this feature.
- Level 2 – these are the next most commonly assigned programs for this feature.
- Level 3 – these programs are not often assigned and require an expert level working knowledge of the system to be properly assigned.

Program Number	Program Name/Description	Input Data	Default	Level		
				1	2	3
20-09-05	<b>Class of Service Options (Incoming Call Service) – Signal/Voice Call</b> Turn Off or On an extension user ability to enable Handsfree Answerback or Forced Intercom Ringing for their incoming Intercom calls.	0 = Off 1 = On	COS 1 ~ 15 = 1		✓	
20-09-06	<b>Class of Service Options (Incoming Call Service) – Incoming Time Display</b> If this option is set to 1, the Incoming Call Time is displayed on the multiline terminal LCD while the telephone is ringing. ➤ <i>Caller ID should be enabled for this feature in Program 20-09-06 to function.</i>	0 = Off 1 = On	COS 1 ~ 15 = 0	✓		
20-09-07	<b>Class of Service Options (Incoming Call Service) – Call Queuing</b> Turn Off or On an extension user ability to have calls queued if a call rings the extension when it is busy. ➤ <i>Program 20-13-06 must be set to 0 (Off) for this feature to work.</i>	0 = Off 1 = On	COS 1 ~ 15 = 1		✓	
20-13-05	<b>Class of Service Options (Supplementary Service) – Intercom Off-Hook Signaling</b> Turn Off or On an extension ability to send off-hook signals. ➤ <i>This setting functions with Programs 20-09-07 and 20-13-06 disabled.</i>	0 = Off 1 = On	COS 1 ~ 15 = 1	✓		
20-13-06	<b>Class of Service Options (Supplementary Service) – Automatic Off-Hook Signaling (Automatic Override)</b> Allow a busy extension user to Manually (0) or Automatically (1) receive off-hook signals. ➤ <i>This setting is to receive incoming call signaling information during call queuing.</i>	0 = Off 1 = On	COS 1 ~ 15 = 1	✓		
20-13-35	<b>Class of Service Options (Supplementary Service) – Block Camp-On</b> Turn Off or On an extension user ability to block callers from dialing to camp-on.	0 = Off 1 = On	COS 1 ~ 15 = 0		✓	



Operation

None

## Delayed Ringing

### Description

Delayed Ringing allows programmed secondary answering positions to ring on incoming calls after a programmed time. This feature applies to CO/PBX lines, Secondary Incoming Extensions, Virtual Extensions, and Call Arrival Keys.

#### Conditions

- An extension user can answer an outside call just by lifting the handset (depending on programming).
- Terminals must have a CAP or CO line appearance for a trunk call to be answered on the telephone.

#### Default Settings

None

### System Availability

#### Terminals

All Terminals

#### Required Component(s)

None

### Related Features

- ➔ **Call Arrival (CAR) Keys**
- ➔ **Central Office Calls, Answering**
- ➔ **Secondary Incoming Extension**
- ➔ **Video Conference with Web RTC**

## Guide to Feature Programming

The **Level 1**, **Level 2** and **Level 3** columns indicate the programs that are assigned when programming this feature in the order they are most commonly used. These levels are used with PCPro and WebPro wizards for feature programming.

- Level 1 – these are the most commonly assigned programs for this feature.
- Level 2 – these are the next most commonly assigned programs for this feature.
- Level 3 – these programs are not often assigned and require an expert level working knowledge of the system to be properly assigned.

Program Number	Program Name/Description	Input Data	Default	Level		
				1	2	3
14-07-01	<b>Trunk Access Map Setup</b> Set up the Trunk Access Maps. This sets the access options for trunks. Ring Group programming overrides Access Map programming.	0 = No access 1 = Outgoing access only 2 = Incoming access only 3 = Access only when trunk on Hold 4 = Outgoing access and access when trunk on Hold 5 = Incoming access and access when trunk on Hold 6 = Incoming and Outgoing access 7 = Incoming access, outgoing access and access when trunk on Hold Trunk Access Maps: 1 ~ 400	Access Maps 1 ~ 400 = Trunk Ports 1 ~ 400 assigned with option 7 access (incoming and outgoing access and access when trunk is on Hold).			✓
15-06-01	<b>Trunk Access Map for Extensions</b> Assign Trunk Access Maps to extensions.	Trunk Access Maps: 1 ~ 400	1			✓
15-07-01	<b>Programmable Function Keys</b> Assign CAR/SIE/VE function keys (code *03 + extension number) or CO function keys (Code *01 + trunk port) on multiline terminals.	Line Key 1 ~ 48 0 ~ 99 (Normal Function Code 751 by default) *00 ~ *99 (Appearance Function Code) (Service Code 752 by default)	Refer to the Programming Manual for default values.	✓		
15-09-01	<b>Virtual Extension Ring Assignment</b> Individually program an extension Virtual Extension key(s) to either Ring or Not Ring.	Mode 1: 0 = Not Ring 1 = Ring	0	✓		
15-11-01	<b>Virtual Extension Delayed Ring Assignment</b> Assign the delayed ringing options for an extension Virtual Extension or Virtual Extension Group Answer keys (defined in Program 15-09).	KY01 Mode 1: 0 = Immediate Ring 1 = Delayed Ring	0	✓		
20-04-03	<b>System Options for Virtual Extensions – CAR/SIE/Virtual Extension Delay Interval</b> CAR Keys/SIE Keys/Virtual Extensions set for Delayed Ringing (see Program 15-11) ring the extension after this time.	0 ~ 64800 seconds	10		✓	

Program Number	Program Name/Description	Input Data	Default	Level		
				1	2	3
22-01-04	<b>System Options for Incoming Calls – DIL No Answer Recall Time</b> A DIL that rings its programmed destination longer than this time diverts to the DIL No Answer Ring Group (set in Program 22-08).	0 ~ 64800 seconds 0 = No Overflow	0	✓		
22-02-01	<b>Incoming Call Trunk Setup</b> Set the feature type for the trunk you are programming.	Trunks 1 ~ 400 0 = Normal 1 = VRS (second dial tone if no VRS installed) 2 = DISA 3 = DID 4 = DIL 5 = E&M Tie line 6 = Delayed VRS 7 = ANI/DNIS 8 = DID(DDI) Mode Switching	0	✓		
22-08-01	<b>DIL/IRG No Answer Destination</b> If an incoming trunk call rings longer than the DIL No Answer Time (Program 22-01-04), it routes to the destination you specify in this option. Determine if the destination should be a Ring Group, In-Skin/External Voice Mail, or Central Voice Mail.	0 = (No Setting) 001 ~ 100 = Incoming Ring Group 102 = (In-Skin/ External Voice Mail or InMail)	1	✓		

## Operation

### To answer Delay Ringing calls:

1. Go off-hook.
- OR -
- Press **Answer**.
- OR -
- Press the flashing key.
- ◇ *Either Trunk key or CAR/SIE/VE key.*

### To program a CAR/SIE/VE key on a phone:

1. Press **Speaker**.
2. Dial **752**.
3. Press the key you want to program.
4. Dial **\*03**.

5. Dial the number of the extension you want to appear on the key.
6. Press **Hold** once for Immediate Ring (skip to step 8 for Delayed Ring).
7. Dial the mode number in which the key rings.
  - 1 = Day 1
  - 2 = Night 1
  - 3 = Midnight 1
  - 4 = Rest 1
  - 5 = Day 2
  - 6 = Night 2
  - 7 = Midnight 2
  - 8 = Rest 2
8. Press **Hold** for a second time for Delayed Ring, or Skip to step 10.
9. Dial the mode number in which the key delay rings.
  - 1 = Day 1
  - 2 = Night 1
  - 3 = Midnight 1
  - 4 = Rest 1
  - 5 = Day 2
  - 6 = Night 2
  - 7 = Midnight 2
  - 8 = Rest 2
10. Press **Speaker**.

## Department Calling

### Description

With Department Calling, an extension user can call an idle extension in a programmed Department Group (64 Department Groups available) by dialing the group pilot number. For example, this would let a caller dial the Sales department just by knowing the Sales department pilot number. The caller does not have to know any Sales department extension number.

Two types of routing are available with Department Calling: Priority Routing and Circular Routing. With Priority Routing, an incoming call routes to the highest priority extensions first. Lower priority extensions ring only if all higher priority extensions are busy. With Circular Routing, each call rings a new extension.

### Overflow Routing

Department Calling also provides overflow routing for extensions in the group. If a user directly dials a busy extension in a Department Group, the system can optionally route the call to the first available group member. The system follows Program 22-15-01~22-15-07 for playing the periodic VRS message.

Department Calling also allows each Department group to transfer calls to a predefined Speed dial bin (Program 24-05-01) immediately or after a Delayed time (Program 24-02-08). Internal and transferred calls are not supported for Delayed transfer.

### DID and Overflow Routing

Three types of Overflow are supported for DID calls:

Immediate Transfer:

This feature can be enabled or disabled by using a (58) key programmed in Program 15-07. It can also be done by using the service codes in Program 11-11-25 (set) and Program 11-11-26 (cancel). When this feature is activated, any DID calls pointed directly to the Pilot Number go immediately to the transfer destination and do not ring anyone in the group. To set up the destination you use Program 24-05 and Program 13-04. Once these programs are set, the access code assigned in Program 11-11-27 can be used to change the destination as needed.

Delay:

This feature can be enabled or disabled by using a (59) key programmed in Program 15-07. It can also be done by using service codes assigned in Program 11-11-28 (set) and Program 11-11-29 (cancel). When this feature is activated, any DID call pointed directly to the Pilot follows one of the two patterns:

- If all available members are busy or logged out, the call goes immediately to the transfer destination.
- If agents are logged in and not busy, the call comes in and hunts through the idle members until the time in Program 24-02-08 expires. Once this time expires, the call is routed to the transfer destination assigned in Program 24-05 and Program 13-04. After these programs are assigned, the access code assigned in Program 11-11-27 can be used to change the destination as needed.

- DND:**  
This feature can be enabled by using a (60) key programmed in Program 15-07 or by using service codes assigned in Program 11-11-30 (set) and Program 11-11-31 (cancel). When this feature is activated any DID pointed directly to the Pilot gets a busy tone and the call does not route.

### User Log Out/Log In

An extension user can log out and log in to a Department Calling Group. By logging out, the user removes their extension from the group. Once logged out, Department Calling bypasses their extension. When they log back in, Department Calling routes to their extension normally. All users can dial a code to log in or log out of their Department Calling Group. A multiline terminal can optionally have a function key programmed to login/logout.

### Enhanced Hunting

Department Calling is enhanced with expanded hunting abilities. Hunting sets the conditions under which calls to a Department Group pilot number cycle through the members of the group. The hunting choices are:

- Busy**  
A call to the pilot number hunts past only a busy group member to the first available extension.
- Not Answered**  
A call to the pilot number cycles through the idle members of a Department Calling group. The call continues to cycle until it is answered or the calling party hangs up. If the Department Group has Priority Routing enabled, and the highest priority member is busy, the call does not hunt to the next available extension.
- Busy or Not Answered**  
A call to the pilot number cycles through the idle members of a Department Calling group. The call continues to cycle until it is answered or the calling party hangs up.

If all members of the Department Group are busy, an incoming or transferred call to the group pilot number queues for an available member. Each group has a queue that can hold any number of waiting calls. If a display telephone is waiting in queue, the user sees: *WAITING (group name)*. If a transferred call in queue is an outside call, and the system has a DSP daughter board installed with the VRS, the queued caller hears, *"Please hold on. All lines are busy. Your call will be answered when a line becomes free."*

The VRS also can transfer calls to Department Groups. Refer to [Voice Response System \(VRS\) on page 2-1831](#) for information on setting up the VRS.

The system prevents hunting to a Department Group extension if it is:

- Busy on a call**
- In Do Not Disturb**
- Call Forwarded**
- Logged Out**

## Conditions

- When a DIL rings to a Department Group, the DIL may follow overflow programming (Program 22-01-04 and Program 22-08-01).
- If all agents are logged out and an intercom call is made to the Department Group, the caller hears a busy signal.
- Extensions in a Department Group which have Call Forwarding enabled are not included in the call hunt. The extension to which the user is forwarded does not receive the hunted calls. When you use the automatic Department Step calling (Program 16-01-03) it hunts only to members with the same or lower priority.
- Easily step call to an idle Department Group member if the member called is busy.
- A virtual extension can be programmed to receive multiple calls which can camp-on to the extension – no analog port is required.
- An extension user can Transfer a call to a Department Group Pilot number. If unanswered, the call recalls (depending on programming) the transferring extension after the Transfer Recall Time (Program 24-02-04).
- Voice mail uses one Department Group for voice mail.
- When Program 16-01-05 is set to (1) Automatic, all telephones in the Department group Ring for ICM calls & DID calls Directed to the Department Group Pilot Number only.
- The Overflow feature is supported only for DID calls pointed directly to the Pilot Number. POTS lines and transferred DIDs ignore the Overflow settings.
- When a Department Group is assigned as the VM Department Group in Program 45-01-01 it only works as priority mode no matter what Program 16-01-02 is set to for that Department Group.
- Program 16-01-05 (Extension Group All Ring Mode Operation) does not work to a Secondary Department Group.
- Department Queuing will not work to Secondary Group Extensions.

## Default Settings

Disabled



### Priority Routing

Figure 2-8 Department Calling Priority Call Routing

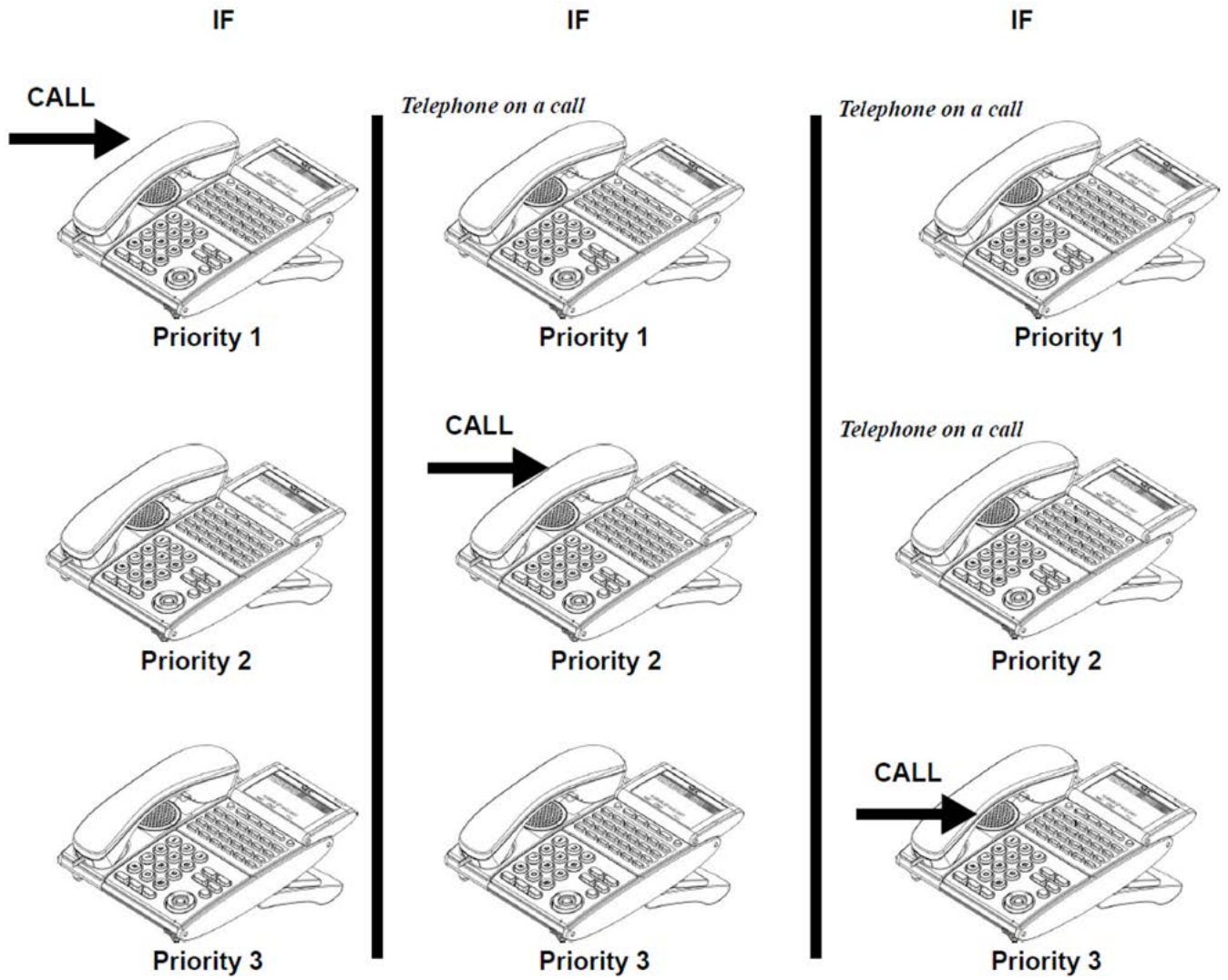

## Circular Routing

Figure 2-9 Department Calling Circular Routing

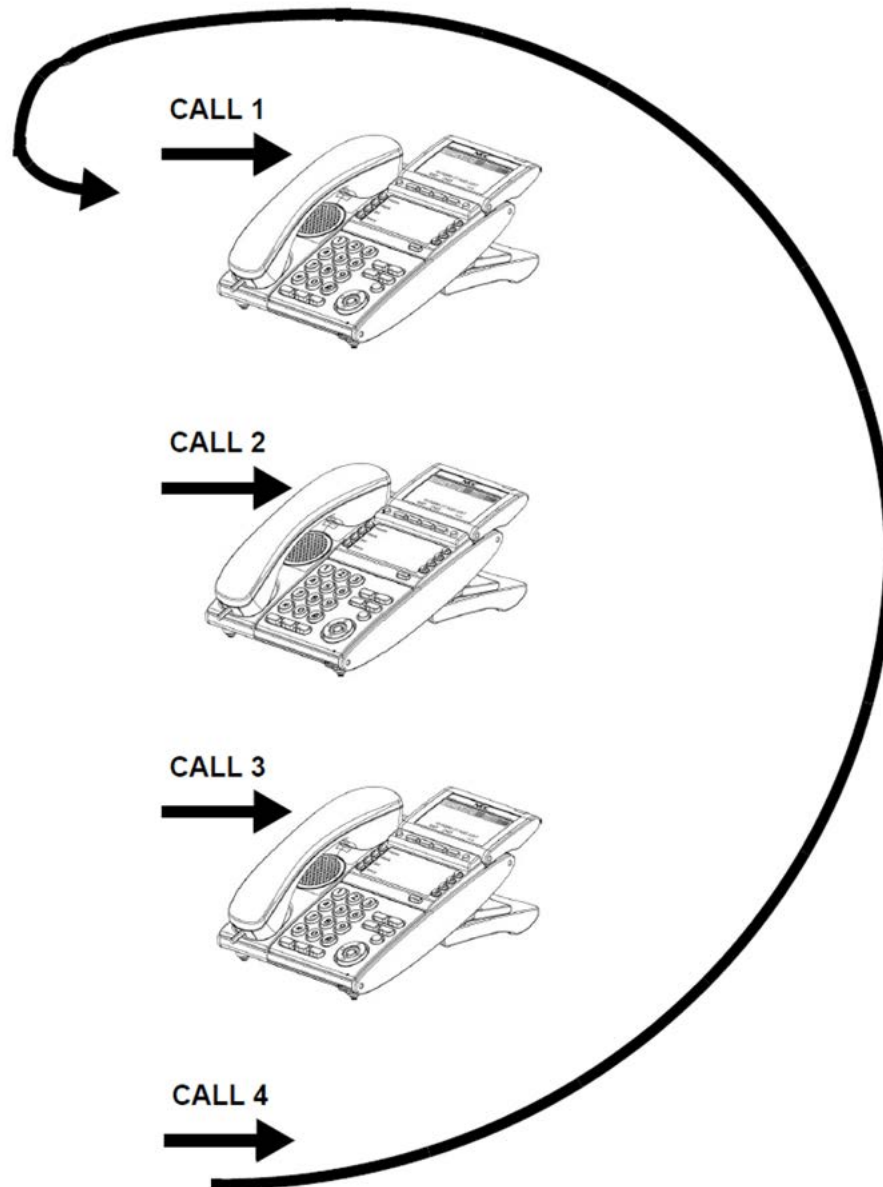

## System Availability

Terminals

All Terminals

## Required Component(s)

VRS for Messaging

## Related Features

- ➔ [Call Arrival \(CAR\) Keys](#)
- ➔ [Call Forwarding](#)
- ➔ [Department Calling](#)
- ➔ [Transfer](#)
- ➔ [InMail](#)
- ➔ [Voice Response System \(VRS\)](#)

## Guide to Feature Programming

The **Level 1**, **Level 2** and **Level 3** columns indicate the programs that are assigned when programming this feature in the order they are most commonly used. These levels are used with PCPro and WebPro wizards for feature programming.

- Level 1 – these are the most commonly assigned programs for this feature.
- Level 2 – these are the next most commonly assigned programs for this feature.
- Level 3 – these programs are not often assigned and require an expert level working knowledge of the system to be properly assigned.

Program Number	Program Name/Description	Input Data	Default	Level		
				1	2	3
11-07-01	<b>Department Group Pilot Numbers – Dial</b> Assign pilot numbers to each Department Group set up.	Dial (maximum of eight digits)	No Setting	✓		
11-11-25	<b>Service Code Setup (for Setup/Entry Operation) – Automatic Transfer Setup for Each Extension Group</b> Set the service code to activate immediate automatic transfer for ICM and transferred calls to Department Groups.	MLT, SLT 0 ~ 9, *, # Maximum of eight digits	602		✓	
11-11-26	<b>Service Code Setup (for Setup/Entry Operation) – Automatic Transfer Cancellation for Each Extension Group</b> Set the service code to deactivate immediate automatic transfer for ICM and transferred calls to Department Groups.	MLT, SLT 0 ~ 9, *, # Maximum of eight digits	603		✓	

Program Number	Program Name/Description	Input Data	Default	Level		
				1	2	3
11-11-27	<b>Service Code Setup (for Setup/Entry Operation) – Destination of Automatic Transfer Each Extension Group</b> Set the service code for setting the destination for immediate automatic transfer for ICM and transferred calls to Department Groups.	MLT 0 ~ 9, *, # Maximum of eight digits	604		✓	
11-11-28	<b>Service Code Setup (for Setup/Entry Operation) – Delayed Transfer for Every Extension Group</b> Set the delayed transfer destination Department Group.	MLT, SLT 0 ~ 9, *, # Maximum of eight digits	605		✓	
11-11-29	<b>Service Code Setup (for Setup/Entry Operation) – Delayed Transfer Cancellation for Each Extension Group</b> Cancel the delayed transfer destination Department Group.	MLT, SLT 0 ~ 9, *, # Maximum of eight digits	606		✓	
11-12-09	<b>Service Code Setup (for Service Access) – Change to STG (Department Group) All Ring</b> Set the service code for ringing all members of a Department Group.	MLT, SLT 0 ~ 9, *, # Maximum of eight digits	No Setting		✓	
11-16-10	<b>Single Digit Service Code Setup – (Department) STG All Ring Mode</b> Assign the Single Digit (post-dialing) Service Code for All Member Ring.	0 ~ 9, *, # Maximum of one digit	No Setting		✓	
15-07-01	<b>Programmable Function Keys</b> Assign a Department Calling key (46) so extension users can install or remove themselves from the Department Calling Group. Additional keys can also be assigned for Department Group features immediate calling destination (58), delayed calling destination (59) and DND destination (60).	Line Key 1 ~ 48 0 ~ 99 (Normal Function Code 751 by default) *00 ~ *99 (Appearance Function Code) (Service Code 752 by default)	Refer to the Programming Manual for default values.		✓	
16-01-01	<b>Department Group Basic Data Setup – Department Name</b> Assign a name to the Extension (Department) Groups.	Maximum of 12 characters	No Setting		✓	
16-01-02	<b>Department Group Basic Data Setup – Department Calling Cycle</b> Set the routing cycle for calls into a department (i.e., when a user dials the department pilot number). The system can ring the highest priority extension available (Priority Routing, 0) or cycle in circular order to a new idle extension for each new call (Circular Routing, 1).	0 = Normal Routing (Priority) 1 = Easy – UCD Routing (Circular)	0		✓	

Program Number	Program Name/Description	Input Data	Default	Level		
				1	2	3
16-01-03	<p><b>Department Group Basic Data Setup – Department Routing When Busy (Auto Step Call)</b></p> <p>Set how the system routes an Intercom call to a busy Department Group member. The caller can hear busy tone (0) or overflow to the first available Department Group member (1). This option is for Intercom calls to an extension, not a pilot number.</p>	<p>0 = Normal (Intercom caller to busy department member hears busy)</p> <p>1 = Circular (Intercom callers to busy department member routes to idle member)</p>	0		✓	
16-01-04	<p><b>Department Group Basic Data Setup – Hunting Mode</b></p> <p>Set if an unanswered call should hunt once stopping at the last member tried (0) or continually hunt through the idle members (1).</p>	<p>0 = Last extension is called and hunting is stopped</p> <p>1 = Circular</p>	0		✓	
16-01-05	<p><b>Department Group Basic Data Setup – Extension Group All Ring Mode Operation</b></p> <p>Set if all members of the group should ring Automatically or use the service code defined in Program 11-12-09. Selecting automatic overrides the settings of Programs 16-01-03 and 16-01-04.</p>	<p>0 = Manual</p> <p>1 = Automatic</p>	0		✓	
16-01-06	<p><b>Department Group Basic Data Setup – STG Withdraw Mode</b></p> <p>Set the STG withdraw mode for each department group.</p>	<p>0 = Disable (Camp On)</p> <p>1 = Enable (Overflow Mode)</p>	0		✓	
16-01-07	<p><b>Department Group Basic Data Setup – Call Recall Restriction for STG</b></p> <p>Determine whether or not an unanswered call transferred to a Department Group should recall the extension from which it was transferred.</p>	<p>0 = Disable (Recall)</p> <p>1 = Enable (No Recall)</p>	0		✓	
16-01-09	<p><b>Department Group Basic Data Setup – Department Hunting No Answer Time</b></p> <p>Set the time a call rings a Department Group extension before hunting occurs.</p>	0 ~ 64800 seconds	15		✓	
16-01-10	<p><b>Department Group Basic Data Setup – Enhanced Hunt Type</b></p> <p>Set the type of hunting for each Extension (Department) Group.</p>	<p>0 = No queuing</p> <p>1 = Hunting When Busy</p> <p>2 = Hunting When Not Answered</p> <p>3 = Hunting When Busy or No Answer</p>	0		✓	
16-02-01	<p><b>Department Group Assignment for Extensions</b></p> <p>Set up the Department Group called by the pilot number and the extension priority when a group is called.</p> <p>Call Pickup Groups are set up in Program 23-02.</p>	<p>Department Groups 1 ~ 64</p> <p>Priority 1 ~ 9999</p>	<p>Default = 1 extensions in Department Group 1 with priority in port order:</p> <p>Port 1 priority = 1</p> <p>Port 256 priority = 256</p>	✓		

Program Number	Program Name/Description	Input Data	Default	Level		
				1	2	3
16-03-01	<b>Secondary Department Group</b> Assign extensions to multiple Department Groups and set the priority assignment. Each Secondary Department Group can have up to 16 extensions assigned.	Extension Number Maximum of eight digits Priority Order 0 ~ 9999	No Setting		✓	
16-04	<b>Call Restriction Between Department Groups</b> Calls between members of different Department (Station) groups can be restricted per group.	0 ~ 64	0		✓	
20-06-01	<b>Class of Service for Extensions</b> Assign a Class of Service (1 ~ 15) to extensions.	Day Night/Mode: 1 ~ 8 Class of Service of Extensions (1 ~ 15)	Extension port 101 = Class 15 All other extension port = Class 1		✓	
20-09-07	<b>Class of Service Options (Incoming Call Service) – Call Queuing</b> Turn Off or On an extension user ability to have calls queued if a call rings the extension when it is busy. ➡ Program 20-13-06 must be set to 0 (Off) for this feature to work.	0 = Off 1 = On	COS 1 ~ 15 = 1		✓	
20-11-17	<b>Class of Service Options (Hold/Transfer Service) – Department Group Trunk-to-Trunk Transfer (Each Telephone Group Transfer)</b> Turn Off or On an extension user in a Department Group ability to use the Trunk-to-Trunk Forwarding service codes.	0 = Off 1 = On	COS 1 ~ 15 = 1		✓	
20-13-06	<b>Class of Service Options (Supplementary Service) – Automatic Off-Hook Signaling (Automatic Override)</b> Allow a busy extension user to Manually (0) or Automatically (1) receive off-hook signals. ➡ This setting is to receive incoming call signaling information during call queuing.	0 = Off 1 = On	COS 1 ~ 15 = 1		✓	
20-13-14	<b>Class of Service Options (Supplementary Service) – Department Calling (PLT No Called Extension)</b> Turn Off or On an extension user ability to call a Department Group Pilot.	0 = Off 1 = On	COS 1 ~ 15 = 1		✓	

Program Number	Program Name/Description	Input Data	Default	Level		
				1	2	3
22-02-01	<b>Incoming Call Trunk Setup – Incoming Type</b> If you want a trunk to be a DIL to a Department Group, assign Service Type 4 for each Night Service Mode. Refer to Program 22-07-01.	Incoming Type for Day/Night Mode (1 ~ 8): 0 = Normal 1 = VRS (second dial tone if no VRS installed) 2 = DISA 3 = DID 4 = DIL 5 = E&M Tie line 6 = Delayed VRS 7 = ANI/DNIS 8 = DID(DDI) Mode Switching	0		✓	
22-07-01	<b>DIL Assignment</b> For each trunk assigned Service Type 4 in Program 22-02-01 above, assign the DIL destination as the Department Group pilot number (as assigned in Program 11-07-01). ➡ For this selection to work, set Program 22-02-01 to 4 (DIL).	Day/Night Modes (1 ~ 8): Extension Number (maximum of eight digits) Pilot Number	No Setting		✓	
24-02-05	<b>System Options for Transfer – Message Wait Ring Interval Time</b> For Single Line Telephones (SLTs) without message waiting lamps, this is the time between intermittent ringing. If this value is set to 0, the system rings once.	0 ~ 64800 seconds	30		✓	
24-02-08	<b>System Options for Transfer – Delayed Transfer Timer for All Department Groups</b> Determine the time a call should ring a Department Group before transferring the call.	0 ~ 64800 seconds	10		✓	
24-05-01	<b>Department Group Transfer Target Setup</b> Assign the Speed Dial bin to each Department Group to hold the destination for the immediate automatic transfer of ICM and transferred calls to the Department Group feature.	0 ~ 9999	9999		✓	

## Operation

### To call a department group:

1. Go off-hook.
2. Dial department extension number.  
◇ The system routes the call to the first free telephone in the department group.
3. **Optional:** To manually ring all members of the group, dial the single digit service code assigned for All Member Ring (Program 11-16-10).

### To log out of your Department Calling Group:



*While you are logged out, Department Calling cannot route calls to your extension.*

NOTE

1. Press **Speaker**
2. Dial **650 + 1**.

- OR -

Press **Department Calling Log In** key (Program 15-07-01 or SC 751: 46).

◇ *The key lights while you are logged out.*

### To log back in to your Department Calling Group:



*When you log back in, Department Calling routes calls to your extension.*

NOTE

1. Press **Speaker**.
2. Dial **650 + 0**.

- OR -

Press Department Calling Log In key (Program 15-07-01 or SC 751: 46).

◇ *The key goes out when you log back in.*

### To change the Department Group Overflow Destination:

1. Press **Speaker**.
2. Dial **604 + Department Group** (01 ~ 64).
3. Dial **01 ~ 08** (Refer to Program 24-05).
4. Dial the destination the calls **route to**.
5. Press **Hold**.



## Department Step Calling

### Description

After calling a busy Department Calling Group member, an extension user can have Department Step Calling quickly call another member in the group. The caller does not have to hang up and place another Intercom call if the first extension called is unavailable. Department Step Calling also allows an extension user to cycle through the members of a Department Group.

### Conditions

- If required, use this option to change the Department Step Calling Single Digit Service Code (default code = 2).
- A function key for Department Step Calling can be assigned (code 36).
- In Program 20-08-12, enable (1) or disable (0) an extension user ability to use Department Step Calling.

### Default Settings

Enabled

### System Availability

#### Terminals

All Terminals

#### Required Component(s)

None

### Related Features

- ➔ **Department Calling**
- ➔ **Programmable Function Keys**

## Guide to Feature Programming

The **Level 1**, **Level 2** and **Level 3** columns indicate the programs that are assigned when programming this feature in the order they are most commonly used. These levels are used with PCPro and WebPro wizards for feature programming.

- Level 1 – these are the most commonly assigned programs for this feature.
- Level 2 – these are the next most commonly assigned programs for this feature.
- Level 3 – these programs are not often assigned and require an expert level working knowledge of the system to be properly assigned.

Program Number	Program Name/Description	Input Data	Default	Level		
				1	2	3
11-12-07	<b>Service Code Setup (for Service Access) – Step Call</b> If required, customize the Step Call service code used by an extension user.	MLT, SLT 0 ~ 9, *, # Maximum of eight digits	708		✓	
11-16-01	<b>Single Digit Service Code Setup – Step Call</b> If required, change the Department Step Calling Single Digit Service Code.	0 ~ 9, *, # Maximum of one digit	2		✓	
15-07-01	<b>Programmable Function Keys</b> Assign a function key Department Step Calling (code 36).	Line Key 1 ~ 48 0 ~ 99 (Normal Function Code 751 by default) *00 ~ *99 (Appearance Function Code) (Service Code 752 by default)	Refer to the Programming Manual for default values.		✓	
20-06-01	<b>Class of Service for Extensions</b> Assign a Class of Service (1 ~ 15) to extensions.	Day Night/Mode: 1 ~ 8 Class of Service of Extensions (1 ~ 15)	Extension port 101 = Class 15 All other extension port = Class 1	✓		
20-08-12	<b>Class of Service Options (Outgoing Call Service) – Department Group Step Calling</b> Turn Off or On an extension user ability to use Department Group Step Calling.	0 = Off 1 = On	COS 1 ~ 15 = 1	✓		

## Operation

### To make a Step Call:

1. Place a call to a busy Department Group member.  
- OR -  
Place a call to a Department Group pilot number.
2. Dial Department Step Code (2) to call the next available Department Group member.
3. Repeat step 2 to call other Department Group members.  
◇ *You step through Department Groups set in Program 16-02-01.*

## Dialing Number Preview

### Description

Dialing Number Preview lets a display multiline terminal user dial and review a number before the system dials it. Dialing Number Preview helps the user avoid dialing errors.

#### Conditions

- An extension user cannot edit the displayed number.
- To place an outgoing call, an extension user must have outgoing access to a line, CAP or trunk group key.
- If the system has VRS or InMail installed, pressing \* to preview a number is not required.

#### Default Settings

Enabled

### System Availability

#### Terminals

All Multiline Terminals with Display

#### Required Component(s)

None

### Related Features

- ↪ **Central Office Calls, Placing**
- ↪ **Voice Response System (VRS)**

## Guide to Feature Programming

The **Level 1**, **Level 2** and **Level 3** columns indicate the programs that are assigned when programming this feature in the order they are most commonly used. These levels are used with PCPro and WebPro wizards for feature programming.

- Level 1 – these are the most commonly assigned programs for this feature.
- Level 2 – these are the next most commonly assigned programs for this feature.
- Level 3 – these programs are not often assigned and require an expert level working knowledge of the system to be properly assigned.

Program Number	Program Name/Description	Input Data	Default	Level		
				1	2	3
20-06-01	<b>Class of Service for Extensions</b> Assign a Class of Service (1 ~ 15) to extensions.	Day Night/Mode: 1 ~ 8 Class of Service of Extensions (1 ~ 15)	Extension port 101 = Class 15 All other extension port = Class 1		✓	
20-08-05	<b>Class of Service Options (Outgoing Call Service) – Dial Number Preview (Preset Dial)</b> Turn Off or On an extension user ability to use Dial Number Preview.	0 = Off 1 = On	COS 1 ~ 15 = 1		✓	

## Operation

### To use Dial Number Preview to place a call (multiline terminal only):

1. Do not lift the handset or press **Speaker**.
2. Dial **\***.
  - ◇ *Skip to step 3 if a VRS or InMail is not installed.*
3. To preview *any number*, dial the number you want to call.  
To preview a Speed Dial – System/Group number, press **Redial** and dial the Speed Dial – System/Group bin number you want to call.
  - ◇ *The number is displayed.*
4. To dial out the displayed trunk number, press a Line/Trunk Group key.
  - ◇ *If the previewed number as a trunk access code (e.g., 9), you can press **Speaker** instead.*

**- OR -**

To dial an Intercom number, press **Speaker**.

**- OR -**

To cancel the number without dialing it out, press **Hold**.

## Dial Pad Confirmation Tone

### Description

For an extension with Dial Pad Confirmation Tone enabled, the user hears a beep each time they press a key. This feature works when the terminal is in an idle state. The tone is heard during active calls.

### Conditions

- Dial Pad Confirmation Tone does not apply to single line telephones or Wireless DECT (SIP) Terminals.
- When this feature is disabled a tone is heard in the handset as well as in hands-free mode.
- When this feature is disabled and any dial pad key is pressed on an idle terminal, the confirmation tone is not heard.

### Default Settings

Disabled

### System Availability

#### Terminals

All Multiline Terminals

#### Required Component(s)

None

### Related Features

None

## Guide to Feature Programming

The **Level 1**, **Level 2** and **Level 3** columns indicate the programs that are assigned when programming this feature in the order they are most commonly used. These levels are used with PCPro and WebPro wizards for feature programming.

- Level 1 – these are the most commonly assigned programs for this feature.
- Level 2 – these are the next most commonly assigned programs for this feature.
- Level 3 – these programs are not often assigned and require an expert level working knowledge of the system to be properly assigned.

Program Number	Program Name/Description	Input Data	Default	Level		
				1	2	3
11-11-19	<b>Service Code Setup (for Setup/Entry Operation) – Key Touch Tone On/Off</b> If required, change the service code to enable or disable the Key Touch Tone.	MLT 0 ~ 9, *, # Maximum of eight digits	724		✓	

## Operation

### To enable/disable Dial Pad Confirmation Tone:

1. Pick up the handset or press **Speaker**.
2. Dial **724**.

## Dial Tone Detection

### Description

If a trunk has Dial Tone Detection enabled, the system monitors for dial tone from the Telco or PBX when a user places a call on that trunk. If the user accesses the trunk directly (by pressing a line key or dialing # 9 and the trunk number), the system drops the trunk if dial tone does not occur. If the user accesses the trunk via a Trunk Group (by dialing a trunk group code or automatically using a feature like Last Number Redial), the system can drop the trunk or optionally skip to the next trunk in the group. Refer to the chart under Programming for more information.

#### Conditions

None

#### Default Settings

Disabled for manually dialed calls; enabled for automatically dialed calls.

### System Availability

#### Terminals

All Terminals

#### Required Component(s)

None

### Related Features

- ↳ **Automatic Route Selection (ARS)**
- ↳ **Call Appearance (CAP) Keys**
- ↳ **Central Office Calls, Placing**
- ↳ **Last Number Redial**
- ↳ **Save Number Dialed**
- ↳ **Speed Dial – System/Group/Station**
- ↳ **T1 Trunking (with ANI/DNIS Compatibility)**



➔ **Trunk Groups**

➔ **Trunk Group Routing**

## Guide to Feature Programming

The **Level 1**, **Level 2** and **Level 3** columns indicate the programs that are assigned when programming this feature in the order they are most commonly used. These levels are used with PCPro and WebPro wizards for feature programming.

- Level 1 – these are the most commonly assigned programs for this feature.
- Level 2 – these are the next most commonly assigned programs for this feature.
- Level 3 – these programs are not often assigned and require an expert level working knowledge of the system to be properly assigned.

Program Number	Program Name/Description	Input Data	Default	Level		
				1	2	3
10-09-01	<b>DTMF and Dial Tone Circuit Setup</b> If dial tone detection is enabled, be sure to allocate at least one circuit for dial tone detection [ICM/Trunk (0) or Trunk (2)].	0 = Common Use 1 = Extension Only 2 = Trunk Only	Circuit/Resource 01 ~ 08 = 1 (Extensions) Circuit/Resource 09 ~ 32 = 2 (Trunks) Circuit/Resource 33 ~ 144 = 0 (Common) When GPZ-BS10 is installed, 81 ~ 144 are available		✓	
14-02-05	<b>Analog Trunk Data Setup – Dial Tone Detection for Manually Accessed Trunks</b> Enable/Disable dial tone detection for directly accessed trunks. If disabled, the system outdials on the trunks without monitoring for dial tone.	0 = Dial Tone Detection Not Used 1 = Dial Tone Detection Used	0		✓	
14-02-11	<b>Analog Trunk Data Setup – Next Trunk in Rotary if No Dial Tone</b> If Enabled, the system skips over a trunk if dial tone is not detected. This option pertains to calls placed using Call Appearance (CAP) Keys, Speed Dial, ARS, Last Number Redial or Save Number Dialed. It does not pertain to line key or Direct Trunk Access calls.	0 = Disable 1 = Enable	0		✓	

Program Number	Program Name/Description	Input Data	Default	Level		
				1	2	3
21-01-04	<b>System Options for Outgoing Calls – Dial Tone Detection Time</b> If dial tone detection is Enabled, the system waits this time for the Telco to return dial tone. When the time expires, the system assumes dial tone is not present. To disable this time (and have the system wait continuously), enter 0.	0 ~ 64800 seconds	5		✓	
21-01-05	<b>System Options for Outgoing Calls – Disconnect Time When Dial Tone Not Detected</b> If 14-02-11 is Enabled, the system skips over a trunk if dial tone is not detected. This option pertains to calls placed using Speed Dial, ARS, Last Number Redial or Save Number dialed. It does not pertain to line key or Direct Trunk Access calls.	0 ~ 64800 seconds	3		✓	
21-01-06	<b>System Options for Outgoing Calls – Dial Pause at First Digit</b> If Dial Tone Detection is Disabled, the system waits this time before sending dialed digits. If using Dial Tone Detection, this time should be set longer than the time set in Program 21-01-05, otherwise, if this time is set shorter than Program 21-01-05, Dial Tone Detection is satisfied and Program 21-01-05 is disregarded (not used).	0 ~ 64800 seconds	1		✓	

Table 2-12 Dial Tone Detection Program Interaction

Method	14-02-05	14-02-11	Result if dial tone not present . . .
Press a line key - or - Dial #9+ Trunk number	0	0	Trunk hangs (does not disconnect)
	0	1	Trunk hangs (does not disconnect)
	1	0	Trunk drops
	1	1	Trunk drops
Dial a Trunk Group code - or - Automatically through a feature	0	0	Trunk hangs (does not disconnect)
	0	1	Trunk reroutes after time-out
	1	0	Trunk drops
	1	1	Trunk reroutes after time-out

## Operation

Dial Tone Detection is automatic if enabled in programming.

## Digital Trunk Clocking

### Description

The UNIVERGE SV9100 GCD-CP10 has a built-in clock source for all digital trunk blades. Digital trunk blades are connected via an internal PLO (Phase Locked Oscillator) to derive Primary Clock from the network in priority order. If priority is set up incorrectly, or if two primary clocks are coming in, slips may occur causing improper data synchronization. The PLO, equipped with the UNIVERGE SV9100 GCD-CP10 is the timing source for all digital trunk blades in the system. The PLO synchronizes the system and clocks signals from another office. When the UNIVERGE SV9100 is a clock receiver office, the PLO generates the clock signal according to the source clock signals received from the source office in the network. The source clock signals are extracted from digital trunk blades and are supplied to the PLO.

The PLO synchronization source priorities are as follows:

1. GCD-PRTA
2. GCD-CCTA (External)
3. GCD-2BRIA
4. GCD-CP10

### Conditions

- If multiple PRIs exist, the system chooses the first one that synchronized with the carrier.
- If there are multiple PRIs and the one being used for the source goes down, the system begins to count forward in slot numbers looking for the next available PRI.
- If multiple BRIs exist and no GCD-PRTA or GCD-CCTA (External) exists, the SV9100 GCD-CP10 chooses the first BRI that synchronized with the carrier.
- If there is one GCD-PRTA and the one being used for the source goes down, the SV9100 GCD-CP10 looks to see if there are any BRIs installed in the system. If there are no BRIs, the SV9100 GCD-CP10 becomes the new synchronization source. The reason for this is when a GCD-PRTA is installed in the system, all T1s must be assigned as (INTERNAL). T1 (INTERNAL) is not a clocking priority.

### Default Settings

None

## System Availability

### Terminals

None

### Required Component(s)

- GCD-CP10
- GCD-2BRIA

**-OR-**

- GCD-PRTA, GCD-CCTA

## Related Features

- ➔ **ISDN Compatibility**
- ➔ **K-CCIS – T1**
- ➔ **T1 Trunking (with ANI/DNIS Compatibility)**

## Feature Examples

Digital Trunk Clocking Examples:

If multiple PRIs exist, the first one that synchronized with the carrier is chosen. In this example, the PRI in 02 was the first to synchronize with the carrier; therefore, it is the PLO synchronization source.

*Figure 2-10 Digital Trunk Clocking Example 1*

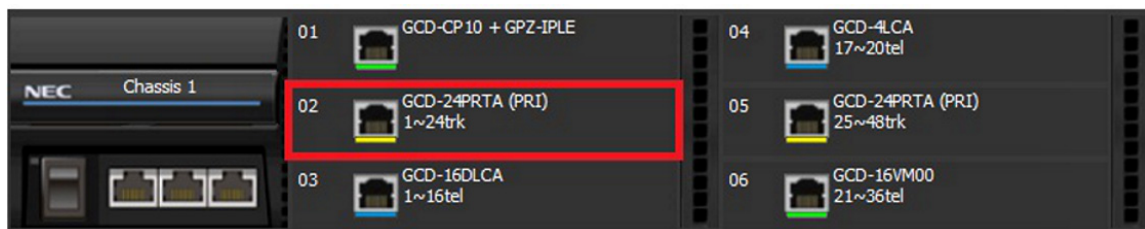

If there are multiple PRIs and the one being used for the source goes down, the system begins to count forward in slot numbers looking for the next available PRI. In this example, the PRI in 02 went down, so the system now begins looking forward in slot numbers for the next PRI to use as the clock source.

Figure 2-11 Digital Trunk Clocking Example 2



In this example, the PRI in 05 was the first to synchronize with the carrier and became the PLO synchronization source. The PRI in 05 then went down and the system began looking forward in slot numbers to find the next PLO source. In this case, the PRI in 02 was the next source because after it looks through the rest of the slots in the system, it starts over with 01.

Figure 2-12 Digital Trunk Clocking Example 3



In this example, there are multiple T1 circuits in the system. There can only be one T1 circuit assigned as EXTERNAL in the system, so the T1 assigned as EXTERNAL is the PLO synchronization source.

Figure 2-13 Digital Trunk Clocking Example 4



In this example, there are multiple T1 circuits and a BRI circuit. Since the T1 assigned as EXTERNAL has higher priority than a BRI, the T1 EXTERNAL is the PLO synchronization source.

Figure 2-14 Digital Trunk Clocking Example 5



In this example, there is a PRI, multiple T1s, and a BRI. The PRI was the PLO synchronization source until it went down. The BRI then becomes the PLO synchronization source because when a PRI is in the system, T1s cannot be assigned as EXTERNAL, which are not in the PLO synchronization source priority list.

Figure 2-15 Digital Trunk Clocking Example 6



If multiple BRIs exist but no PRI or T-1 EXTERNAL exists, the system chooses the first BRI that synchronized with the carrier. In this example, the BRI in 04 synchronized with the carrier first and became the PLO synchronization source.

Figure 2-16 Digital Trunk Clocking Example 7



In this scenario, the PRI was the clocking source until it went down. There are no other PRIs, T1 (Externals), or BRIs in the system. The GCD-CP10 now becomes the PLO synchronization source.

Figure 2-17 Digital Trunk Clocking Example 8



## Guide to Feature Programming

Refer to the related features section for links to associated features.

## Operation

Refer to the related features section for links to associated features.

## Directed Call Pickup

### Description

Directed Call Pickup permits an extension user to intercept a call ringing another extension. This allows a user to conveniently answer a call for a co-worker from their own telephone. With Directed Call Pickup, an extension user can pick up:

- Trunk calls (i.e., Ring Group calls)
- Direct Inward Lines
- Transferred trunk calls
- Transferred Intercom calls
- Ringing and voice-announced Intercom calls

### Conditions

- Calls which were on hold or transferred which recall the extension can be answered using Directed Call Pickup.
- Personal Park also uses the Directed Call Pickup code.
- Voice Mail Park and Page also uses the Directed Call Pickup code.
- Directed Call Pickup cannot be used to pick up a call ringing at a agent.

### Default Settings

Enabled

### System Availability

#### Terminals

All Terminals

#### Required Component(s)

None



## Related Features

- ➔ [Call Arrival \(CAR\) Keys](#)
- ➔ [Department Calling](#)
- ➔ [Group Call Pickup](#)
- ➔ [Hold](#)
- ➔ [Hotline](#)
- ➔ [Park](#)
- ➔ [Secondary Incoming Extension](#)
- ➔ [Secretary Call Pickup](#)
- ➔ [Transfer](#)
- ➔ [Video Conference with Web RTC](#)
- ➔ [InMail](#)

## Guide to Feature Programming

The **Level 1**, **Level 2** and **Level 3** columns indicate the programs that are assigned when programming this feature in the order they are most commonly used. These levels are used with PCPro and WebPro wizards for feature programming.

- Level 1 – these are the most commonly assigned programs for this feature.
- Level 2 – these are the next most commonly assigned programs for this feature.
- Level 3 – these programs are not often assigned and require an expert level working knowledge of the system to be properly assigned.

Program Number	Program Name/Description	Input Data	Default	Level		
				1	2	3
11-12-25	<b>Service Code Setup (for Service Access) – Direct Call Pickup - Own Group</b> Customize the Service Codes for direct call pickup – own group.	MLT, SLT 0 ~ 9, *, # Maximum of eight digits	756		✓	
11-12-26	<b>Service Code Setup (for Service Access) – Call Pickup for Specified Group</b> Customize the Service Codes for call pickup for specified group.	MLT, SLT 0 ~ 9, *, # Maximum of eight digits	768		✓	
11-12-27	<b>Service Code Setup (for Service Access) – Call Pickup</b> Customize the Service Codes for call pickup.	MLT, SLT 0 ~ 9, *, # Maximum of eight digits	* #		✓	

Program Number	Program Name/Description	Input Data	Default	Level		
				1	2	3
11-12-28	<b>Service Code Setup (for Service Access) – Call Pickup for Another Group</b> Customize the Service Codes for call pickup for another group.	MLT, SLT 0 ~ 9, *, # Maximum of eight digits	769		✓	
11-12-29	<b>Service Code Setup (for Service Access) – Direct Extension Call Pickup</b> Customize the Service Codes for direct extension call pickup.	MLT, SLT 0 ~ 9, *, # Maximum of eight digits	**	✓		
11-12-30	<b>Service Code Setup (for Service Access) – Specified Trunk Answer</b> Customize the Service Codes for specified trunk answer.	MLT, SLT 0 ~ 9, *, # Maximum of eight digits	672		✓	
20-06-01	<b>Class of Service for Extensions</b> Assign a Class of Service to extensions (1 ~ 15).	Day Night/Mode: 1 ~ 8 Class of Service of Extensions (1 ~ 15)	Extension port 101 = Class 15 All other extension port = Class 1		✓	
20-10-05	<b>Class of Service Options (Answer Service) – Directed Call Pickup for Own Group</b> Turn Off or On Directed Call Pickup for calls ringing an extension Pickup Group (Service Code 756).	0 = Off 1 = On	COS 1 ~ 15 = 1	✓		

## Operation

### To use Directed Call Pickup to intercept a call to a co-worker’s extension:

1. Pick up the handset or press **Speaker**.
2. Dial **\*\***.
3. Dial number of extension whose call you want to intercept.
  - ◇ *If more than one call is coming in, the system sets the priority for which call it answers first.*

## Directory Dialing

### Description

Directory Dialing allows a multiline terminal user to select a co-worker or outside caller from a list of names, rather than dialing the telephone number. Four types of Directory Dialing are available:

- SPD–Speed Dials
- EXT–Co-worker’s Extensions
- STA–Personal Speed Dials
- TELBK–Telephone Book

### Conditions

- Directory Dialing sorts and searches directory names in alphabetical order (based on all characters entered of the name) when the system starts up or reboots. The system resorts extension names when:
  - You change Program 15-01-01 (Extension Numbers and Names).
  - Any user dials 700 and changes their extension name.
- Directory Dialing follows all the programmed options and conditions for Speed Dial - System/Group/Station, Intercom Calling and One-Touch Calling.
- Extension Directory only shows a telephones/VEs that are connected and have a name assigned in Program 15-01-01.
- Pressing the **Right Cursor Key** twice (on equipped terminals) displays the Common/Group Speed Dial directory.
- Pressing the **Right Cursor Key** three times (on equipped terminals) displays the Extension Name directory.

### Default Settings

Enabled

### System Availability

#### Terminals

All Multiline Terminals with Display and Softkeys

Bluetooth Cordless Handset

## Required Component(s)

None

## Related Features

- ➔ **Last Number Redial**
- ➔ **Name Storing**
- ➔ **Speed Dial – System/Group/Station**
- ➔ **Softkeys**

## Guide to Feature Programming

The **Level 1**, **Level 2** and **Level 3** columns indicate the programs that are assigned when programming this feature in the order they are most commonly used. These levels are used with PCPro and WebPro wizards for feature programming.

- Level 1 – these are the most commonly assigned programs for this feature.
- Level 2 – these are the next most commonly assigned programs for this feature.
- Level 3 – these programs are not often assigned and require an expert level working knowledge of the system to be properly assigned.

Program Number	Program Name/Description	Input Data	Default	Level		
				1	2	3
20-13-51	<b>Class of Service Options (Supplementary Service) – Number and Name Appear in the Directory</b> Determine if an extension name and number should be listed (1) or unlisted (0) in the directory.	0 = Off 1 = On	COS 1 ~ 15 = 1		✓	
21-01-02	<b>System Options for Outgoing Calls – Intercom Interdigit Time</b> If a user waits longer than this time between Directory Dialing steps, Directory Dialing automatically cancels.	0 ~ 64800 seconds	10	✓		

## Operation

### To use Directory Dialing from a multiline terminal with an LCD:

1. Press the **Dir** softkey.  
- OR -  
Press the **Right Cursor** key.
2. Press the **softkey** for the Directory Dialing type:
  - SPD–Speed Dials
  - EXT–co-worker’s Extensions
  - STA–Personal Speed Dials
  - TELBK–Telephone Book
    - ◇ *Directory Dialing follows any feature restrictions that your system may have enabled. For example, if your extension cannot normally use Speed Dial - System/Group/Station, Directory Dialing can not access it either.*
3. Dial letter/number range for the party you want to call (e.g., dial 2 for A, B, C or 2).
  - ◇ *You can enter several letters to help narrow the search.*
  - ◇ *Press # to enter additional letters on the same key (ex: TOM = 8666#6).*
4. Press the **Down Arrow** softkey to jump to that section.
5. Press the Volume **▲** or **▼** key to scroll through the list.
  - ◇ *If you wait too long between your selections, Directory Dialing automatically cancels.*
6. Lift the handset or press the **DIAL** softkey, or press **Speaker** to place the selected call.
  - ◇ *If you selected an outside call, it routes according to your system Trunk Group Routing/ARS setup.*

### To cancel Directory Dialing:

Press the **Exit** key.

## Direct Inward Dialing (DID)

### Description

Direct Inward Dialing (DID) lets outside callers directly dial system extensions. DID saves time for callers who know the extension number they wish to reach. To place a DID call, the outside caller dials the local exchange (NNX) and additional digits to ring the telephone system extension. For example, DID number 926-5400 can directly dial extension 400. The caller does not have to rely on attendant or secretary call screening to complete the call.



NOTE

*Direct Inward Dialing (DID) requires DID service from Telco.*

In addition to direct dialing of system extensions, DID provides:

- DID Dialed Number Translation
- Flexible DID Service Compatibility
- DID Intercept
- DID Camp-On



NOTE

*There are 20 DID Translation tables that can be divided between 4000 entries.*

### DID Dialed Number Translation

DID allows different tables for DID number translation. This gives you more flexibility when buying DID service from Telco. If you cannot buy the exact block of numbers you need (e.g., 301~556), use the translation tables to convert the digits received. For example, a translation table could convert digits 501~756 to extension numbers 301~556.

The UNIVERGE SV9100 system has 4000 DID Translation Table entries that you can allocate among the 20 DID Translation Tables. One translation is made in each entry. For a simple installation, you can put all 4000 entries in the same table. For more flexibility, you can optionally distribute the 4000 entries among the 20 tables.

In addition to number conversion, each DID Translation Table entry can have a name assigned to it. When the DID call rings the destination extension, the programmed name is displayed.

### Flexible DID Service Compatibility

With three-digit service, the Telco sends three digits to the system for translation. Be sure to program your system for compatibility with the provided Telco service. For example, if the Telco sends four digits, make sure you set up the translation tables to accept four digits.

The system is compatible with Dial Pulse (DP) and DTMF DID signaling. DID trunks can be either wink start, immediate start, 2nd Dial or Delay.

## DID Camp-On

DID Camp-On sets what happens to DID calls to busy extensions when you have Busy Intercept disabled. With DID Camp-On enabled, a call to a busy extension camps-on for the DID Ring No Answer Time. It then diverts to the programmed DID Intercept extension ring group or Voice Mail. Without DID Camp-On, the caller to the busy extension hears only busy tone.

## DID Routing Through the VRS

DID calls can optionally route through the VRS. The DID caller hears an initial Automated Attendant Greeting explaining their dialing options. If the caller misdials, they hear a second greeting with additional instructions. For example, the first Automated Attendant Greeting can be, "Thank you for calling. Please dial the extension number you wish to reach or dial 0 for the operator." If the caller inadvertently dials an extension that does not exist, they could hear, "The extension you dialed is unavailable. Please dial 0 for assistance or dial # to leave a message so we can call you back."

You assign Automated Attendant greetings (i.e., VRS Messages) to the numbers in each Translation Table. This provides you with extensive flexibility when determining which greetings the system should play for which dialed numbers. You could, for example, set up 926 5401 through 926 5449 to route to extensions 401~449, and have 926 5450 route to the automated attendant.



NOTE

*If you translate a DID so that it hits a specific VRS message, you must disable Program 25-01-02. Otherwise, the outside caller waits while hearing the DISA dial tone.*

The system allows an extension to be defined as a 1-digit number that can be dialed by the outside caller on a DID/DISA trunk using the VRS. The outside caller can access the desired extension/department group by dialing only one digit after the system answers the call. If the same number is used as the first digit of an extension number and the 1-digit access code for DID/DISA, the outside caller cannot access the extension.

### EXAMPLE:

If 2 is defined as a 1-digit access code to department group 300, outside callers cannot access extensions 200~299 directly.

## SMDR Includes Dialed Number

The SMDR report can optionally print the trunk name (entered in system programming) or the number the incoming caller dialed (i.e., the dialed DID digits). This allows you to analyze the SMDR report based on the number your callers dial. (This option also applies to an ISDN trunk.)

## DID Intercept

DID Intercept automatically reroutes DID calls under certain conditions. There are three DID Intercepts:

### Vacant Number Intercept

If a caller dials an extension that does not exist or misdials, Vacant Number Intercept can reroute the call to the programmed DID Intercept extension ring group or Voice Mail. Without Vacant Number Intercept, the caller hears error tone after misdialing.

- ❑ **Busy Intercept**  
Busy Intercept determines DID routing when a DID caller dials a busy extension. If Busy Intercept is enabled, the call immediately routes to the programmed DID Intercept extension ring group or Voice Mail. If Busy Intercept is disabled, the call follows DID Camp-On programming.
- ❑ **Ring-No-Answer Intercept**  
Ring-No-Answer Intercept sets the routing options for DID calls that ring unanswered at the destination extension. With Ring-No-Answer Intercept enabled, the unanswered call reroutes to the DID Intercept extension ring group or Voice Mail after the DID Ring-No-Answer Time. If Ring-No-Answer Intercept is disabled, the unanswered call rings the destination until the outside caller hangs up.

### Delayed DID

Delayed DID allows a user a programmed time to answer a call. If the call is not answered in this time, the system automatically answers the call. An outside party hears a voice message, music, or dial tone according to the following conditions:

- ❑ If VRS is installed, the system sends a recorded message from the VRS.
- ❑ If a customer-provided audio system (example: tape recorder) is connected, an error message or music can be played for the caller.
- ❑ If equipment is not connected for an announcement, the system sends a unique dial tone to the outside caller.

This feature is not available for the normal incoming call on ISDN trunks.

### DID Intercept Destination for Each DID Number

With this feature the system allows you to program a DID Intercept destination for a DID number which receives no answer or busy call. The system can be programmed to use a trunk ring group, the VRS or the voice mail as the programmed destination. Each vacant number intercept for a DID number can have two destinations. The first destination is for an invalid DID number, busy or no answer extension. The second destination is for a no answer trunk ring group.



NOTE

*If the first programmed destination is a Ring Group and the second Destination is Voice Mail, the call does not forward to VoiceMail.*

For busy or no answer intercept calls, a third destination can be defined in Program 22-12. If the first and third destinations are programmed but the second destination is not, the incoming call goes to the third destination after the first destination. If the first and second destinations are not programmed, but the third destination is, the call goes directly to the third destination.

This feature works for DID trunks with a trunk service type 3 in Program 22-02. Other types of trunks may use the DID table, but the DID intercept feature is not yet supported.



With the DID Intercept for each DID number feature, when the primary destination (Program 22-11-05) is set to Voice Mail, the Voice Mail protocol is:

1. Busy Intercept = Forward Busy
2. Ring-No-Answer Intercept = Forward RNA

When the secondary destination (Program 22-11-06) is set to Voice Mail, the Voice Mail protocol is based on the first destination routing. When the incoming call is forwarded to the first destination by a busy intercept, the Voice Mail protocol forwards busy calls. When the incoming call is routed to the first destination by a ring-no-answer intercept, the protocol forwards ring-no-answer. The Voice Mail transfers the calls to the mailbox number defined in Program 22-11-02.



- Any valid DID number must be entered in the DID table (Program 22-11 or Program 22-17-01). If a valid DID number is not entered, there is no ring destination for any incoming call to that number (the calls do not ring any extension in the system).
- If the first programmed destination is a Ring Group and the second Destination is Voice Mail, the call does not forward to VoiceMail.

### Calls Can Follow Ring Group Programming for Transferring Calls

An option was added to Program 22-11 which allows you to determine if the DID routing should use the programmed ring group entry in Program 22-12-01 when transferring calls from a busy or no answer number.

If DID digits match the conversion table but there is no extension, no Voice Mail, or Voice Mail did not boot up, use Program 22-11-11 to decide what to do with the incoming call. Go to (1) normal ring (default) or (0) caller hears a Busy Tone.

### DID Call by Time Schedule

DID Call by Time Schedule allows for 500 programmed DID Conversion table entries (**Program 22-17-01**) that can be routed based on Time Patterns. Each DID Conversion table has a maximum of eight programmable Time Patterns and each Time Pattern can reference one of the 4000 different Dial-In Conversion table entries in **Program 22-11-01**.

Example 1 (Automatic Change)

	00:00	09:00	12:00	13:00	18:00	00:00
Time Pattern						
PRG 22-17	1	2	3	4	5	
PRG 22-11-01	1	2	3	2	1	
PRG 22-11-02	100 incoming	101 incoming	102 incoming	101 incoming	100 incoming	

Program 22-11-01 and Program 22-11-02		
Table No.	Receive Dial	Transfer Dial
1	No setting	100
2	No setting	101
3	No setting	102

Program 22-17					
Table No.	Receive Dial	Time Pattern	Start Time	End Time	PRG 22-11
1~500	1111	1	00:00	09:00	1
		2	09:00	12:00	2
		3	12:00	13:00	3
		4	13:00	18:00	2
		5	18:00	00:00	1
		6	00:00	00:00	0
		7	00:00	00:00	0
		8	00:00	00:00	0

Table 2-13 Example 2 (Manual Change)

Program 22-17					
Table No.	Receive Dial	Time Pattern	Start Time	End Time	PRG 22-11
1~500	1111	1	00:00	00:00	1
		2	00:00	00:00	2
		3	00:00	00:00	3
		4	00:00	00:00	0
		5	00:00	00:00	0
		6	00:00	00:00	0
		7	00:00	00:00	0
		8	00:00	00:00	0

**DID Call by Day of Week Schedule**

DID Call by weekly schedule allows for 500 programmed DID Conversion table entries (Program 22-17-01 and Program 22-17-05) that can be routed based on Day of Week Patterns. Each DID Conversion table has a maximum of eight programmable Time Patterns and Day of Week Pattern can reference one of the 4000 different Dial-In Conversion table entries in Program 22-11-01.

**Example 1 (Monday - Friday)**

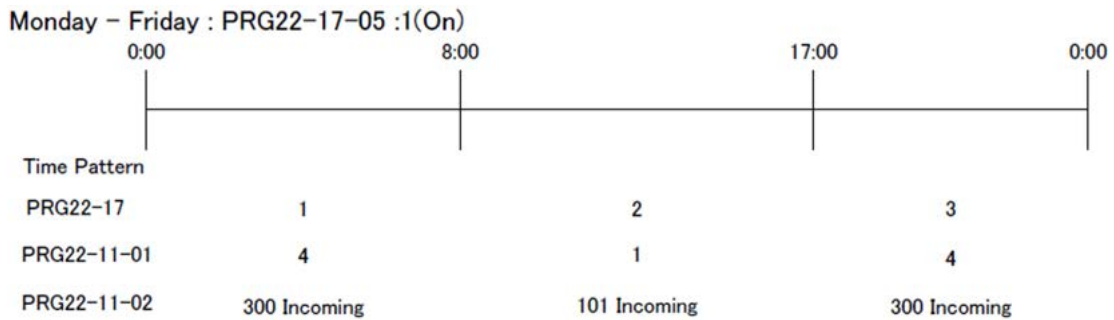

**Example 2 (Saturday)**

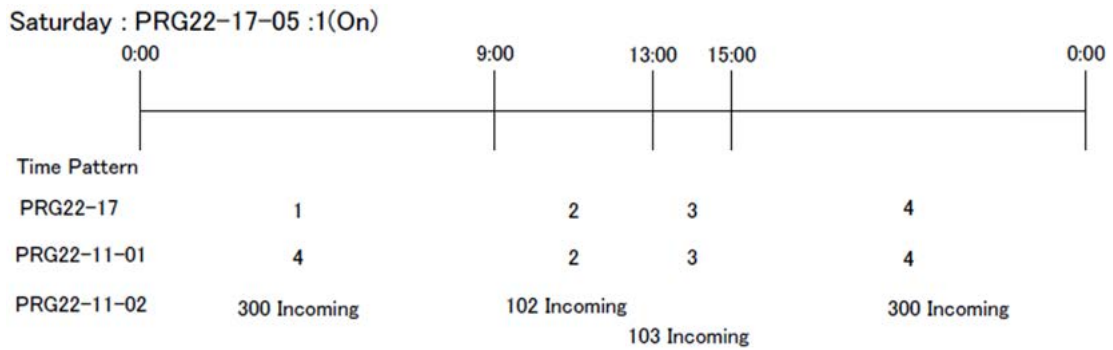

**Example 3 (Sunday)**

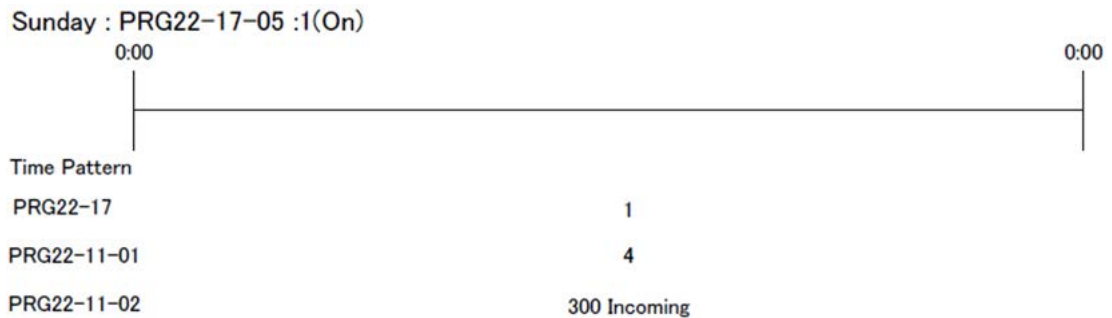

Program 22-11-01 and Program 22-11-02		
Table No.	Receive Dial	Transfer Dial
1	None	101
2	None	102
3	None	103
4	None	300

Table 2-14 Example 1 – Monday ~ Friday

Program 22-17						
Table No.	Receive Dial	Time Pattern	02: Start Time	03: End Time	04: PRG 22-11	05: Day
1	734	1	00:00	08:00	4 (Ext. 300)	Mon-Fri: 1 (On)
	734	2	08:00	17:00	1 (Ext. 101)	
	734	3	17:00	00:00	4 (Ext. 300)	

Table 2-15 Example 2 – Saturday

Program 22-17						
Table No.	Receive Dial	Time Pattern	02: Start Time	03: End Time	04: PRG 22-11	05: Day
2	734	1	00:00	09:00	4 (Ext. 300)	Sat: 1 (On)
	734	2	09:00	13:00	2 (Ext. 102)	
	734	3	13:00	15:00	3 (Ext. 103)	
	734	4	15:00	00:00	4 (Ext. 300)	

Table 2-16 Example 3 – Sunday

Program 22-17						
Table No.	Receive Dial	Time Pattern	02: Start Time	03: End Time	04: PRG 22-11	05: Day
3	734	1	00:00	00:00	4 (Ext. 300)	Sun: 1 (On)

### Federal Communications Commission DID Requirements

Allowing this equipment to operate without providing proper answer supervision signaling violates Part 68 rules.

This equipment returns answer supervision to the Public Switched Telephone Network when the DID trunk is:

- Answered by the called station.
- Answered by the attendant.
- Routed to a recorded announcement that can be administered by the CPE user.
- Routed to a dial prompt.

This equipment returns answer supervision on all DID calls forwarded back to the Public Switched Telephone Network. Permissible exceptions are when:

- A call is unanswered.
- A busy tone is received.
- A reorder tone is received.

When ordering DID service, provide the Telco with the following information:

UNIVERGE SV9100	KF = US:NIFKF07B
	MF = US:NIFMF07B
	PF = US:NIFPF07B
DID Facility Interface Code	02RV2-T
DID Service Order Code	9.0F
DID Answer Supervision Code	A S.2
DID USOC Jack Type	RJ21X

### Conditions

- Analog DID requires the installation of a CD-4DIOPA Blade (provides four DID ports). Depending on programming, the system may assign both trunk and extension ports (if OPX is selected in Program 10-03-01) when this blade is installed.
- DID service must be purchased from your local telephone company.
- DID Intercept for each DID number works for DID trunks with a trunk service type 3 in Program 22-02. Other types of trunks may use the DID table, but the DID intercept feature for each DID number is not yet supported.
- When a call is transferred because of Call Forwarding No Answer, Call Forwarding Busy, or DND, the reason for Transfer option can display to the transferred extension when the call is ringing to their telephone.
- Direct Inward Lines (DILs) also provide a way for outside callers to dial a system extension, virtual extension, or Department Group directly.

- DISA also allows outside callers to dial system extensions directly.
- The Off-Hook Signaling provide DID calls with signaling options. Refer to Off-Hook Signaling for specific details.
- DID trunks do not ring external page speakers. Only trunks defined as normal in Program 22-02-01 ring external page speakers.
- To simplify answering DID calls, assign function keys as line keys for the DID trunks.
- SMDR can print trunk port names or received dialed number for ANI/DNIS or DID trunks. If enabled, DNIS digits can be printed on the SMDR reports instead of the trunk name.
- Transferred calls on DISA, DID, DIL, ISDN trunks, or from the VRS can display the reason a call is being transferred (Call Forward, Busy, No Answer, or DND).
- When defining trunks as DID or DID Mode in Program 22-02-01, DID translation (Program 22-11 or Program 22-17) must be used, even if the incoming digits match the extension number.
- When using DID Call by Time Schedule and breaking out the Time Patterns, set the start time to 00:00 and end time to 00:00 for this feature to operate correctly. Refer to [DID Call by Time Schedule on page 2-421](#) for more details.
- DID Call by Time Schedule Priority is given to the pattern that is set **manually**. However, when a time pattern changes with the time schedules set in Program 22-17, the pattern applied by the Manual change is canceled and the Time Pattern is given priority.
- When Transfer Operation Mode is set to busy, call queuing must be turned off for it to work.
- Incoming calls on T1/ANI trunks can only follow Program 22-11-01. They do not follow Programs 22-11-05 and 22-11-06.
- When a name is assigned to a DID in Program 22-11-03, the name is displayed during a ringing DID call. When the call is transferred or forwarded, the name is not displayed until the call is answered.

## Default Settings

Disabled

## Related Features

- ↳ [Central Office Calls, Answering](#)
- ↳ [Direct Inward Line \(DIL\)](#)
- ↳ [Direct Inward System Access \(DISA\)](#)
- ↳ [Off-Hook Signaling](#)
- ↳ [Paging, External](#)

- ➔ **Programmable Function Keys**
- ➔ **Station Message Detail Recording**
- ➔ **Transfer**

## Guide to Feature Programming

The **Level 1**, **Level 2** and **Level 3** columns indicate the programs that are assigned when programming this feature in the order they are most commonly used. These levels are used with PCPro and WebPro wizards for feature programming.

- Level 1 – these are the most commonly assigned programs for this feature.
- Level 2 – these are the next most commonly assigned programs for this feature.
- Level 3 – these programs are not often assigned and require an expert level working knowledge of the system to be properly assigned.

Program Number	Program Name/Description	Input Data	Default	Level		
				1	2	3
10-03-01	<b>ETU Setup</b> Set up and confirm the basic configuration data for each blade. This program represents different data depending on the blade installed in the slot.	The assigned data varies depending on the blade installed in the slot.	Refer to the Programming Manual for a more detailed description of the 10-03-XX programs.	✓		
10-09-01	<b>DTMF and Dial Tone Circuit Setup</b> If the system has DTMF DID trunks, be sure to reserve at least one circuit for analog trunk DTMF reception (type 0 or 2). There must be an available receiver for each DTMF DID trunk. Use the following as a guide when allocating DTMF receivers:  In light traffic sites, allocate one DTMF receiver for every 10 devices that use them.  In heavy traffic sites, allocate one DTMF receiver for every five devices that use them.	0 = Common Use 1 = Extension Only 2 = Trunk Only	Circuit/Resource 01 ~ 08 = 1 (Extensions) Circuit/Resource 09 ~ 32 = 2 (Trunks) Circuit/Resource 33 ~ 144 = 0 (Common) When GPZ-BS10 is installed, 81 ~ 144 are available			✓
14-05-01	<b>Trunk Group – Trunk group Number</b> Put DID trunks in the same trunk group (other than group 1). If you have different types of DID trunks, put each type in a separate trunk group.	Trunk Port 1 ~ 400 Group Number 0 ~ 100 Priority 1 ~ 400	Default = Trunks 1 ~ 400 assigned to trunk group 1 with priorities equal to the trunk number. Trunk 1 = Priority 1 Trunk 400 = Priority 400.	✓		

Program Number	Program Name/Description	Input Data	Default	Level		
				1	2	3
15-07-01	<b>Programmable Function Keys</b> Assign line or Call Appearance (CAP) Keys for DID trunks (Trunks: 1 ~ 400).	Line Key 1 ~ 48 0 ~ 99 (Normal Function Code 751 by default) *00 ~ *99 (Appearance Function Code) (Service Code 752 by default)	Refer to the Programming Manual for default values.	✓		
20-06-01	<b>Class of Service for Extensions</b> Assign a Class of Service (1 ~ 15) to an extension.	Day Night/Mode: 1 ~ 8 Class of Service of Extensions (1 ~ 15)	Extension port 101 = Class 15 All other extension port = Class 1		✓	
20-09-01	<b>Class of Service Options (Incoming Call Service) – Second Call for DID/DISA/DIL/ E&amp;M Override</b> Turn Off or On the extension ability to receive a second call from a DID, DISA, DIL, or tie line caller.  ➡ <i>With this option set to 1, the destination extension must be busy for a second DNIS caller to ring through. If the destination extension does not have a trunk or CAP key available for the second call and a previous call is ringing the extension but has not yet been answered, the second caller hears busy regardless of this program setting.</i>	0 = Off 1 = On	COS 1 ~ 15 = 1		✓	
20-13-23	<b>Class of Service Options (Supplementary Service) – Display the Reason for Transfer</b> Select whether or not an extension should display the reason a call is being transferred to their extension (Call Forward Busy, Call Forward No Answer, DND).	0 = Off 1 = On	COS 1 ~ 15 = 0		✓	
21-01-02	<b>System Options for Outgoing Calls – Intercom Interdigit Time</b> Set the time-out time for DID callers that do not dial. After this time, the DID call routes according to Vacant Number Intercept programming.	0 ~ 64800 seconds	10		✓	
22-01-06	<b>System Options for Incoming Calls – DID Ring-No-Answer Time</b> Set the DID Ring No Answer (RNA) Intercept time. In systems with RNA Intercept, the DID call rings the destination extension for this time, and then rings Intercept Ring Group.	0 ~ 64800 seconds	20		✓	



Program Number	Program Name/Description	Input Data	Default	Level		
				1	2	3
22-02-01	<b>Incoming Call Trunk Setup</b> For each Night Service Mode, enter service type 3 when the trunk should be a DID trunk.	Incoming Type for Day/Night Mode (1 ~ 8): 0 = Normal 1 = VRS (second dial tone if no VRS installed) 2 = DISA 3 = DID 4 = DIL 5 = E&M Tie line 6 = Delayed VRS 7 = ANI/DNIS 8 = DID(DDI) Mode Switching	0	✓		
22-04-01	<b>Incoming Extension Ring Group Assignment</b> Assign extensions to Ring Groups. Calls ring the extensions according to programming in Program 22-06.	Maximum eight digits.	Extensions 101 ~ 108 (first eight ports) ring for incoming Ring Group 1 calls. No other extensions ring for incoming Ring Group 1 calls.		✓	
22-09-01	<b>DID Basic Data Setup – Expected Number of Digits</b> For each DID Translation Table (1 ~ 20), enter the number of digits the table expects to receive from the CO (eight maximum). For example, for a table used with 3-digit DID service, enter 3.	1 ~ 8	4	✓		
22-09-02	<b>DID Basic Data Setup – Received Vacant Number Operation</b> Enable/Disable Vacant Number Intercept.	0 = Disconnect 1 = Transfer	0		✓	
22-10-01	<b>DID Translation Table Setup</b> Assign the start and end range of DID Translation Table entries (1 ~ 4000) to each DID Translation Table (1 ~ 20).	0 ~ 4000 (0 = No Setting)	1st: 1 Start – 1, End – 100 2 Start – 101, End – 200 3 Start – 201, End – 300 4 Start – 301, End – 400 5 ~ 20 Start – 0, End – 0 2nd: 1 ~ 20 Start – 0, End – 0		✓	
22-11-01	<b>DID Translation Number Conversion – Received Number</b> For each DID Translation Table entry (1 ~ 4000), specify the digits received by the system.	Maximum of eight digits	No Setting	✓		

Program Number	Program Name/Description	Input Data	Default	Level		
				1	2	3
22-11-02	<b>DID Translation Number Conversion – Target Number</b> For each DID Translation Table entry (1 ~ 4000), specify the extension the system dials after translation.	Maximum of eight digits	No Setting	✓		
22-11-03	<b>DID Translation Number Conversion – DID Name</b> For each DID Translation Table entry (1 ~ 4000), specify the name that should show on the dialed extension display when it rings.	Maximum of 12 digits	No Setting		✓	
22-11-04	<b>DID Translation Number Conversion – Transfer Operation Mode</b> For each DID Translation Table entry (1 ~ 4000), specify the condition required to transfer the call to the destination defined in Program 22-11-05 and Program 22-11-06.	0 = No Transfer 1 = Busy 2 = No Answer 3 = Both	0		✓	
22-11-05	<b>DID Translation Table Number Conversion – Transfer Destination Number 1</b> Define the 1st transfer destination for each tables received number.	0 = No Setting 1 ~ 100 = Incoming Group 101 = (Not Used) 102 = In-Skin/External Voice Mail or InMail 201 ~ 264 = Extension Group 400 = Valid Extension Number 401 = DISA 501 ~ 599 = DISA/VRS Message 1000 ~ 1999 = Speed Dial Number (000 ~ 999)	0		✓	
22-11-06	<b>DID Translation Table Number Conversion – Transfer Destination Number 2</b> 400 = Allows the outside party to dial a different extension number in the translation table (for example, ring no answer to a dialed number, the caller then hears a dial tone, allowing them to enter another Valid Extension Number). 401 = Provides the caller with DISA dialing options (requires using the DISA password). Note: This applies to 22-11-05 and 22-11-06. ➡ <i>If the Transfer Destinations are busy or receive no answer, those calls are transferred to the final transfer destination (Program 22-10).</i>	0 = No Setting 1 ~ 1 00 = Incoming Group 101 = (Not Used) 102 = In-Skin/External Voice Mail or InMail 201 ~ 264 = Extension Group 400 = Valid Extension Number 401 = DISA 501 ~ 599 = DISA/VRS Message 1000 ~ 1999 = Speed Dial Number (000 ~ 999)	0		✓	
22-11-07	<b>DID Translation Number Conversion – Call Waiting</b> For each DID Translation Table entry (1 ~ 4000), specify whether or not Call Waiting should be allowed.	0 = Disable (No) 1 = Enable (Yes)	0		✓	

Program Number	Program Name/Description	Input Data	Default	Level		
				1	2	3
22-11-08	<b>DID Translation Number Conversion – Maximum Number of DID Calls</b> For each DID Translation Table entry (1 ~ 4000), specify the maximum number of DID calls.	0 ~ 400 (0 = No Limit)	0		✓	
22-11-09	<b>DID Translation Number Conversion – Music On Hold Source</b> For each DID Translation Table entry (1 ~ 4000), specify the source of music to be used for DID trunks.	0 = IC/MOH Port 1 = BGM Port 2 = ACI Port	0		✓	
22-11-10	<b>DID Translation Number Conversion – ACI Music Source Port</b> For each DID Translation Table entry (1 ~ 4000), if item 2 is selected in Program 22-11-09, specify the port to be used for the source of music heard on DID trunks.	When a sound source type is 2 in above: (0 ~ 96)	0		✓	
22-11-11	<b>DID Translation Number Conversion – Ring Group Transfer</b> Enable/Disable each conversion table to follow the Ring Group programming defined in Program 22-12-01: DID Intercept Ring Group. If Program 22-11-05: DID Translation Number Conversion, Transfer Destination Number 1 and Program 22-11-06: DID Translation Number Conversion, Transfer Destination Number 2 are set, the priority of transferring is in this order: Program 22-11-05 then Program 22-11-06 then if Program 22-11-11 is enabled, Program 22-12-01.	0 = Disable (Caller hears Ringback) 1 = Enable (Go to normal ring)	1		✓	
22-12-01	<b>DID Intercept Ring Group</b> For each DID Translation Table, program the DID Intercept destination. The destination can be a Ring Group, In-Skin/External Voice Mail, or Centralized Voice Mail. This program is used when there is no destination programmed in Program 22-11-05. It is unrelated to Program 22-11-06 and Program 22-11-07.	0 (No Setting) 1 ~ 100 (Incoming Ring Group) 102 (In-Skin/External Voice Mail or InMail)	1		✓	
22-13-01	<b>DID Trunk Group to Translation Table Assignment</b> Assign the DID trunk groups to translation tables. If all the DID trunks use the same type of DID service, you may have only one DID trunk group and one DID Translation Table (with many entries).	0 ~ 20 (0 = No Setting)	1		✓	
25-01-01	<b>VRS/DISA Line Basic Data Setup – VRS/DISA Dial-In Mode</b> Determine whether the system should use option 0 or option 1 (Use dial conversion table) for calls.	0 = Extension Number Service Code Specify (Intercom) 1 = Use Dial Conversion Table	0		✓	

Program Number	Program Name/Description	Input Data	Default	Level		
				1	2	3
25-01-03	<b>VRS/DISA Line Basic Data Setup – VRS/DISA Transfer Alarm</b> Determine whether the system should use option 0 or option 1 for calls.	0 = Normal 1 = Alarm	0		✓	
25-02-01	<b>DID/DISA VRS Message</b> For each trunk port and each night mode, select the message source (0 = No Message, 1 = VRS, 2 = ACI, 3 =S LT), assign the VRS message number to be used as the Automated Attendant Message for each trunk, which is assigned as VRS/DISA [with VRS = 01 ~ 48 (VRS message number), with ACI = 1 ~ 4 or 01 ~ 16 (ACI group number), with SLT = 1 ~ 8 or 01 ~ 64 (Department Group number)].	0 = No Message 1 = VRS (01 ~ 100 VRS Message Number) 2 = ACI (01 ~ 04 ACI Group Number) 3 = Department Groups (01 ~ 64 Extension Group Number)	0		✓	
25-03-01	<b>VRS/DISA Transfer Ring Group With Incorrect Dialing</b> For each trunk port, set what happens to a call when the DISA or Automated Attendant caller dials incorrectly or waits too long to dial. The call can either disconnect (0) or Transfer to an alternate destination (a ring group, In-Skin/ External, Centralized). When setting the DISA and DID Operating Mode, you make an entry for each Night Service mode.	Ring Groups: 1 ~ 100 Trunk Ports: 001 ~ 400 Day/Night Mode: 1 ~ 8 0 = Disconnect 1 ~ 100 = Incoming Ring Group 101 DSPDB-VM 102 = In-Skin/External Voice Mail or InMail 104 = Speed Dial Bin (table Program 25-15-01)	0		✓	
25-04-01	<b>VRS/DISA Transfer Ring Group With No Answer/Busy</b> For each trunk port (001 ~ 400), set the operating mode of each DISA trunk. This sets what happens to the call when the DISA or Automated Attendant caller calls a busy or unanswered extension. The call can either disconnect (0) or Transfer to an alternate destination (a ring group, In-Skin/External, Centralized). When setting the DISA and DID Operating Mode, you make an entry for each Night Service mode.	Ring Groups: 1 ~ 100 Trunk Ports: 001 ~ 400 Day/Night Mode: 1 ~ 8 0 (Disconnect) 1 ~ 100 (Incoming Ring Group) 102 (In-Skin/External Voice Mail or InMail) 104 (Speed Dial table Program 25-15-01)	0		✓	
25-05-01	<b>VRS/DISA Error Message Assignment</b> For each trunk that is answered by the VRS, enter the VRS message (1 ~ 48) the outside caller hears if they dial incorrectly after answer. If you enter 0, the call reroutes according to Program 25-03 and Program 25-04. Make one entry for each Night Service mode.	0 ~ 100 (0 = No Setting)	0		✓	

Program Number	Program Name/Description	Input Data	Default	Level		
				1	2	3
25-06-02	<p><b>VRS/DISA One-Digit Code Attendant Setup – Destination Number</b></p> <p>Set up single digit dialing for Automated Attendant callers. For each VRS Message programmed to answer outside calls, specify:</p> <ul style="list-style-type: none"> <li>○ The digit the Automated Attendant caller dials (1~12, where 10 = 0, 11 =* and 12 = #). (Keep in mind that if you assign destinations to digits three and four, outside callers cannot dial system extensions that begin with that digit.)</li> <li>○ The destination reached (four digits maximum) when the caller dials the single digit code.</li> </ul>	Maximum of eight digits	No Setting		✓	
25-07-01	<p><b>System Timers for VRS/DISA – VRS/DISA Dial Tone Time</b></p> <p>After answering a VRS/DISA trunk, the system waits this time for the caller to dial the first digit of the DISA password. If the caller fails to dial in this time, the system drops the call.</p>	0 ~ 64800 seconds	10		✓	
25-07-02	<p><b>System Timers for VRS/DISA – VRS/DISA No Answer Time</b></p> <p>A VRS/DISA caller can ring an extension for this time before the system sets the call as a Ring No Answer. After this time expires, the call follows the programmed Ring No Answer routing (set in Program 25-03 and Program 25-04).</p>	0 ~ 64800 seconds	0		✓	
25-07-04	<p><b>System Timers for VRS/DISA – Calling Time to Automatic Answering Telephone Set</b></p> <p>Set the answering waiting time of the automatic answering extension when an incoming DID trunk call is received.</p>	0 ~ 64800 seconds	10		✓	
25-07-05	<p><b>System Timers for VRS/DISA – Duration Time for Guidance Message by Automatic Answering Telephone Set</b></p> <p>Set the announcement time of the automatic answering extension before an incoming DID trunk caller is disconnected.</p>	0 ~ 64800 seconds	10		✓	
25-07-06	<p><b>System Timers for VRS/DISA – Duration Time for Guidance Message by ACI</b></p> <p>Set the announcement time by the ACI before an incoming DID trunk caller is disconnected.</p>	0 ~ 64800 seconds	10		✓	
25-07-11	<p><b>System Timers for VRS/DISA – VRS/DISA Answer Delay Time</b></p> <p>Set the time the system waits after receiving an incoming VRS/DISA call before the system automatically answers the call.</p>	0 ~ 64800 seconds	0		✓	

Program Number	Program Name/Description	Input Data	Default	Level		
				1	2	3
25-07-13	<b>System Timers for VRS/DISA – VRS/DISA Busy Tone Interval</b> If a DISA caller dials a busy extension (and Program 25-04-01 is set to 0), the system plays busy tone for this time before disconnecting.	0 ~ 64800 seconds	5		✓	
25-07-14	<b>System Timers for VRS/DISA – Delayed VRS Answer Time</b> Assign the delay time from switching from a normal incoming status to DID mode. If this time is set to 0, the call switches to DID mode immediately.	0 ~ 64800 seconds	10		✓	
25-17-01	<b>VRS/DISA Attendant Message Service Setup – Transfer Ring Group at Wrong Dialing</b> Set the transfer destination for VRS, DID, DISA and DID mode switching Trunk. The destination can be a Ring Group Voice Mail or Speed dial.	Attendant Message Number (1~100) 0 = Refer PRG 25-03 1 ~ 100 = Incoming Ring Group 102 = In-Skin/External Voice Mail or InMail 104 = Speed Dial Bin (Program 25-17-03)	0	✓		
25-17-02	<b>VRS/DISA Attendant Message Service Setup – Transfer Ring Group at No Answer/Busy</b> Set the transfer destination for VRS, DID, DISA and DID mode switching Trunk. The destination can be a Ring Group or Voice Mail and Speed dial.	Attendant Message Number (1~100) 0 = Refer PRG 25-04 1 ~ 100 = Incoming Ring Group 102 = In-Skin/External Voice Mail or InMail 104 = Speed Dial Bin (Program 25-17-04)	0	✓		
25-17-03	<b>VRS/DISA Attendant Message Service Setup – Transfer Target Area at Wrong Dialing</b> Assign a speed dial bin target number for wrong dialing/Dial tone timeout.	0 ~ 9999	9999	✓		
25-17-04	<b>VRS/DISA Attendant Message Service Setup – Transfer Target Area at No Answer or Busy</b> Assign a speed dial bin target number for the target extension no answer or busy.	0 ~ 9999	9999	✓		
25-18-01	<b>VRS/DISA Attendant Message Timer Setup – Dial Tone</b> After answering a VRS/DISA trunk, the system waits this time for the caller to dial the first digit.	0 ~ 64800	10	✓		
25-18-02	<b>VRS/DISA Attendant Message Timer Setup – No Answer Time</b> A VRS/DISA caller can ring an extension for this time before the system sets the call as a Ring No Answer.	0 ~ 64800	0	✓		

Program Number	Program Name/Description	Input Data	Default	Level		
				1	2	3
25-18-03	<b>VRS/DISA Attendant Message Timer Setup – Disconnect After VRS/DISA Retransfer to IRG</b> From VRS/DISA trunk, when the call may go to Incoming Ring Group (IRG) or speed dial of Program 25-17-02. This setting determines the time the call is ringing in the IRG or speed dial.	0 ~ 64800	60	✓		
34-01-01	<b>E&amp;M Tie Line Basic Setup – DID/E&amp;M Start Signaling</b> Set the start signaling mode for DID and tie trunks. DID and tie trunks can use either immediate start or wink start signaling.	0 = 2nd Dial Tone 1 = Wink (default) 2 = Immediate 3 = Delay	1	✓		
34-01-02	<b>E&amp;M Tie Line Basic Setup – Receive Dial Type for E&amp;M Tie Line</b> For DID and tie trunks, set the trunks signaling type.	0 = DP 1 = DTMF 2 = MF	1	✓		

**Direct Call by Time Schedule:**

Program Number	Program Name/Description	Input Data	Default	Level		
				1	2	3
11-10-35	<b>Service Code Setup (for Administrator) – Dial-In Mode Switching</b> Assign the service code Dial-In Mode Switching.	MLT, SLT 0 ~ 9, *, # Maximum of eight digits	No Setting	✓		
12-04-01	<b>Holiday Night Service Switching</b> Define a yearly schedule of holiday night-switch settings. This schedule is used for the setting of special days when the company is expected to be closed, such as a national holiday.	Night Mode Service Group No. 01-32 Days and Months 0101 ~ 1231 Time Pattern No. 0 ~ 10 0 = No Setting	No Setting		✓	
15-07-01	<b>Programmable Function Keys</b> Assign a function key for one-touch access to the Dial-In Mode Switching setup code (Code 88).	Line Key 1 ~ 48 0 ~ 99 (Normal Function Code 751 by default) *00 ~ *99 (Appearance Function Code) (Service Code 752 by default)	Refer to the Programming Manual for default values.	✓		
20-07-26	<b>Class of Service Options (Administrator Level) – Dial-In Mode Switch</b> Enable/ Disable an extension user ability to manually change Dial-In Modes.	0 = Off 1 = On	COS 1 ~ 15 = 0	✓		

Program Number	Program Name/Description	Input Data	Default	Level		
				1	2	3
22-02-01	<b>Incoming Call Trunk Setup – Incoming Type</b> For each Night Service Mode, enter service type 8 when the trunk should be a DID (DDI) Mode Switching trunk.	Incoming Type for Day/Night Mode (1 ~ 8): 0 = Normal 1 = VRS (second dial tone if no VRS installed) 2 = DISA 3 = DID 4 = DIL 5 = E&M Tie line 6 = Delayed VRS 7 = ANI/DNIS 8 = DID(DDI) Mode Switching	0		✓	
22-11-02	<b>DID Translation Number Conversion – Target Number</b> For each DID Translation Table entry (1 ~ 4000), specify the extension the system dials after translation. ► Do not assign Received Digits in Program 22-11-01 when using DID Call by Time Schedule.	Maximum of 24 digits	No Setting		✓	
22-17-01	<b>Dial-In Conversion Table Area Setup for Time Pattern – Received Dial</b> Define the received numbers for each Dial-In Conversion Table (Program 22-17-02, 22-17-03 and 22-17-04).	Maximum of eight digits	No Setting		✓	
22-17-02	<b>Dial-In Conversion Table Area Setup for Time Pattern – Start of Time</b> Define the Starting Time for each DID Translation table in Program 22-17-01.	0000 ~ 2359 (Time)	0000		✓	
22-17-03	<b>Dial-In Conversion Table Area Setup for Time Pattern – End of Time</b> Define the Ending Time for each DID Translation table in Program 22-17-01.	0000 ~ 2359 (Time)	0000		✓	
22-17-04	<b>Dial-In Conversion Table Area Setup for Time Pattern – Dial-In Conversion Table Number</b> Assign each time pattern to a DID Translation Table Entry in Program 22-11.	0 ~ 4000	0		✓	
22-17-05	<b>Dial-In Conversion Table Area Setup for Time Pattern – Day of Week</b> Assign day of week for each DID conversion table.	1-8 1: Sunday 2: Monday 3: Tuesday 4: Wednesday 5: Thursday 6: Friday 7: Saturday 8: Holiday	1: On (1-8)			✓



## Operation

DID calls ring extensions like normal trunk calls.

### To Activate DID Call by Time Schedule:

1. At any display multiline terminal, press **Speaker**.
2. Dial the Dial-In Mode Switching Service Code (Default = Not assigned).

**- OR -**

Press the Dial-In Mode Switching Programmable Function key (Program 15-07-01, 88, or SC 751 Key Code 88).

3. Dial **1~100/ 500** (table number).
4. Dial the Time Pattern **1~8**.

*Table 2-17 LED Flash Patterns*

Time Pattern	LED Appearance
Pattern 1	Off
Pattern 2	On
Pattern 3	Slow Flash
Pattern 4	Fast Flash
Patterns 5~8	Off

## Direct Inward Line (DIL)

### Description

A Direct Inward Line (DIL) is a trunk that rings an extension, virtual extension or Department Group directly. Since DILs only ring one extension or group (i.e., the DIL destination), employees always know which calls are for them. For example, a company operator can have a Direct Inward Line for International Sales Information. When outside callers dial the DIL telephone number, the call rings the operator on the International Sales line key. The DIL does not ring other extensions.

There are 400 available trunks, 64 Department Groups, 960 extensions and 512 virtual extensions.

### DIL Delayed Ringing

Extensions in a Ring Group can have delayed ringing for another extension DIL. If the DIL is not answered at its original destination, it rings the DIL No Answer Ring Group. This could help a Technical Service department, for example, that covers calls for an Inside Sales department. If the Inside Sales calls are not answered, they ring to the Technical Service department.

### Conditions

- If unanswered, a DIL without delayed ringing rings an extension until the outside party hangs up.
- If a DIL rings a Department Group and all agents are busy, the system routes the call as follows:
  1. The trunk rings the overflow destination assigned in Program 22-08.
  2. If there is no 22-08 assignment, the call rings according to the Ring Group assignments in Program 22-04 and Program 22-05.
  3. If none of the destinations in steps 1~2 above are available, the call continues to ring until a destination becomes free.
- The DIL follows call forwarding programming, even to voice mail.
- When a call is transferred by Call Forwarding – No Answer, Call Forwarding – Busy, or DND, the Reason for Transfer can display at the transferred extension.
- You can place DILs in trunk groups to make outgoing DIL calls easier.
- If a DIL destination extension is in DND, an incoming call rings according to Ring Group programming (Program 22-05 then Program 22-08).
  - ❑ *If a user puts the telephone in Do Not Disturb, calls routed to the telephone in DND **do not** follow call forwarding.*
- A user can activate Group Call Pickup to intercept a DIL ringing another extension.
- Program a name for a DIL in Program 14-01-01. This makes it easier to identify the incoming call.

- If a multiline terminal is busy, a second incoming DIL call provides Call Alert Notification, depending on chassis programming. The second DIL call waits in line for the user to answer the call. The outside caller hears ringback tone while this occurs.
- If an extension has a line key for a DIL, the call rings the key. If not, the call rings an available line appearance. For other extensions, the DIL indicates busy.
- A DIL rings its assigned extension without Ring Group programming. A DIL only rings its assigned extension. It does not ring other extensions in a Ring Group.
- Transferred calls on DISA, DID, DIL, ISDN trunks, or from the VRS can display the reason a call is being transferred (Call Forward, Busy, No Answer, or DND).

### Default Settings

Disabled

## System Availability

### Terminals

All Terminals

### Required Component(s)

None

## Related Features

- ➔ [Call Forwarding](#)
- ➔ [Central Office Calls, Answering](#)
- ➔ [Central Office Calls, Placing](#)
- ➔ [Department Calling](#)
- ➔ [Do Not Disturb](#)
- ➔ [Group Call Pickup](#)
- ➔ [Name Storing](#)
- ➔ [Off-Hook Signaling](#)
- ➔ [Paging, External](#)
- ➔ [Programmable Function Keys](#)

➔ **Ring Groups**

➔ **Transfer**

## Guide to Feature Programming

The **Level 1**, **Level 2** and **Level 3** columns indicate the programs that are assigned when programming this feature in the order they are most commonly used. These levels are used with PCPro and WebPro wizards for feature programming.

- Level 1 – these are the most commonly assigned programs for this feature.
- Level 2 – these are the next most commonly assigned programs for this feature.
- Level 3 – these programs are not often assigned and require an expert level working knowledge of the system to be properly assigned.

Program Number	Program Name/Description	Input Data	Default	Level		
				1	2	3
15-07-01	<b>Programmable Function Keys</b> To have the DIL ring a key, program a line key for the DIL trunk.	Line Key 1 ~ 48 0 ~ 99 (Normal Function Code 751 by default) *00 ~ *99 (Appearance Function Code) (Service Code 752 by default)	Refer to the Programming Manual for default values.	✓		
20-06-01	<b>Class of Service for Extensions</b> Assign a Class of Service (1 ~ 15) to an extension.	Day Night/Mode: 1 ~ 8 Class of Service of Extensions (1 ~ 15)	Extension port 101 = Class 15 All other extension port = Class 1		✓	
20-09-01	<b>Class of Service Options (Incoming Call Service) – Second Call for DID/DISA/DIL/E&amp;M Override</b> Turn Off or On an extension ability to receive a second call from a DID, DISA, DIL, or tie line caller. ➔ <i>With this option set to 1, the destination extension must be busy for a second DNIS caller to ring through. If the destination extension does not have a trunk or CAP key available for the second call and a previous call is ringing the extension but has not yet been answered, the second caller hears busy regardless of this program setting.</i>	0 = Off 1 = On	COS 1 ~ 15 = 1		✓	
20-13-23	<b>Class of Service Options (Supplementary Service) – Display the Reason for Transfer</b> Select whether or not an extension should display the reason a call is being transferred to their extension (Call Forward Busy, Call Forward No Answer, DND).	0 = Off 1 = On	COS 1 ~ 15 = 0		✓	

Program Number	Program Name/Description	Input Data	Default	Level		
				1	2	3
22-01-04	<p><b>System Options for Incoming Calls – DIL No Answer Recall Time</b></p> <p>A DIL that rings its programmed destination longer than this time diverts to the DIL No Answer Ring Group (set in Program 22-08).</p>	0 ~ 64800 seconds	0		✓	
22-02-01	<p><b>Incoming Call Trunk Setup</b></p> <p>Assign each DIL Service Type 4. Make an entry for each Night Service mode.</p>	Trunks 1 ~ 400 0 = Normal 1 = VRS (second dial tone if no VRS installed) 2 = DISA 3 = DID 4 = DIL 5 = E&M Tie line 6 = Delayed VRS 7 = ANI/DNIS 8 = DID(DDI) Mode Switching	0	✓		
22-04-01	<p><b>Incoming Extension Ring Group Assignment</b></p> <p>Assign the extensions that should receive the overflow to the ring group programmed in Program 22-08. Set the ringing in Program 22-06.</p>	Maximum of eight digits.	Extensions 101 ~ 108 (first eight ports) ring for incoming Ring Group 1 calls. No other extensions ring for incoming Ring Group 1 calls.		✓	
22-07-01	<p><b>DIL Assignment</b></p> <p>Set the destination extension number for each DIL – for each Night Service mode. The destination can be an extension port, virtual extension number, or Department Group pilot number (as assigned in Program 11-07-01).</p> <p>► For this selection to work, set Program 22-02-01 to 4 (DIL).</p>	Day/Night Modes (1 ~ 8): Extension Number (maximum of eight digits) Pilot Number	No Setting	✓		
22-08-01	<p><b>DIL/IRG No Answer Destination</b></p> <p>For each DIL with delayed ringing, enter the DIL No Answer Ring Group. An unanswered DIL rings this group after the DIL No Answer Time. Make an entry for each Night Service mode.</p>	0 = (No Setting) 001 ~ 100 = Incoming Ring Group 102 = (In-Skin/ External Voice Mail or InMail)	1		✓	

## Operation

### To answer a call on your Direct Inward Line:

1. Lift the handset.
2. Press the flashing line key for DIL on the multiline terminal.
  - Press the flashing Answer Key to put the first call on hold and answer the second incoming call. This can be repeated until all incoming calls are answered.
  - If you have Ringing Line Preference, lift the handset to answer the call.
  - If you do not answer the call, it may ring other extensions (i.e., the DIL No Answer Ring Group).

### To place a call on your Direct Inward Line:

1. Lift the handset.
2. At the multiline terminal, press the line key for DIL.
  - OR -
  - Dial # **9** and the DIL trunk number (e.g., 005).
  - OR -
  - Dial **704** and the DIL trunk group number (e.g., 05).
  - OR -
  - Dial **9** for Trunk Group Access.
3. Dial the number.

## Direct Inward System Access (DISA)

### Description

DISA permits outside callers to directly dial system extensions, trunks and selected features. This could help an employee away from the office that wants to directly dial co-workers or use the company trunks for long distance calls. To use DISA, the employee:

- Dials the telephone number that rings the DISA trunk
- Waits for the DISA trunk to automatically answer with a unique dial tone
- Dials the 6-digit DISA password (access code)
- Waits for a second unique dial tone
- Accesses a system trunk, uses a selected feature or dials a system extension

DISA calls ring system extensions like other outside calls. If an extension has a line key for the DISA trunk, the call rings that key. If the extension does not have a line key, the extension must have a Call Appearance (CAP) key to answer the call.

You can set DISA operation differently for each Night Service mode. For example, a trunk can be a normal trunk during the day and a DISA trunk at night. You can also set the routing for DISA trunks when the caller dials a busy or unanswered extension, dials incorrectly or forgets to dial.

DISA allows 15 users, 15 DISA Classes of Service and 400 trunks.

### DISA Class of Service

DISA Class of Service provides features and dialing restrictions for DISA callers. This allows you to control the ability of the DISA callers dialing into your system. When a DISA caller first accesses the system, they can be prompted to enter a DISA password before proceeding. The system associates the password entered with a specific user number, which in turn has a Class of Service. If the Class of Service allows the action (such as making outgoing trunk calls), the call goes through. If the DISA Class of Service does not allow the action, the system prevents the call. The DISA Class of Service options are:

- Trunk Group Routing/ARS Access  
When a DISA caller dials into the system, they may be able to dial 9 and place outside calls. Any toll charge is incurred by the system. The call follows the system Trunk Group Access or Automatic Route Selection (ARS) – whichever is enabled.
- Trunk Group Access  
DISA callers may access a specific trunk group for outgoing calls through the system. To access a Trunk Group, the user dials Service Code 704 followed by the Trunk Group number (Trunk Groups 1~100). This allows the DISA caller to place an outgoing call over the selected group. Trunk Group Access bypasses the system Trunk Group Routing/ARS/Trunk Access Maps. As with dial 9 access, toll charges are incurred by the system.

- Speed Dial - System/Group/Station**  
The System Speed Dial dialing bins may be available to DISA callers. This could save the DISA caller time when dialing. To access the System Speed Dialing bins, the caller dials Service Code #2 and the System Speed Dial Bin number.
- Operator Calling**  
A DISA caller may dial 0 for the system operator.
- Paging**  
Internal and External Paging may be available to DISA callers. This allows co-workers in adjacent facilities, for example, to broadcast announcements to each other.
- Direct Trunk Access**  
DISA callers may select a specific trunk for outgoing calls through the system. To directly access a trunk, the user dials Service Code #9 followed by the trunk number (e.g., 001). This allows the DISA caller to place an outgoing call over the selected trunk. Direct Trunk Access bypasses the system Trunk Group Routing/ARS/Trunk Access Maps. As with dial 9 access, any toll charges are incurred by the system.
- Call Forward**  
DISA callers can set Call Forwarding to redirect extension calls to another extension. Call Forwarding ensures that the user's calls are covered when they are away from their work area.
- DISA/Tie Trunk Barge-In**  
The DISA/Tie Trunk Barge-In option allows a DISA/Tie Line caller to break into another extension user's established call. This sets up a three-way conversation between the intruding party and the two parties on the initial call.

### DISA Toll Restriction

The digits a DISA caller dials for an outgoing call may be subject to the system Toll Restriction. For example, Toll Restriction can prevent users from dialing a 1-900 service. When an incoming DISA caller tries to use system trunks to dial 1-900, Toll Restriction denies the call.

### DISA Operating Modes

The DISA Operating Modes determine what happens when a DISA caller forgets to dial, calls a busy or unanswered extension or dials incorrectly. The system can either drop the call or send it to a preset Ring Group (called the DISA Transfer Destination).

### Department Calling with Overflow Message

If a DISA caller dials a busy Department Calling Group, the system can periodically play the voice prompt, *"Please hold on. All lines are busy. Your call will be answered when a line becomes free."* while the caller waits. The interval between the voice prompts is the VRS Waiting Message Interval Time. When an extension in the Department Group becomes available, the call automatically goes through. If the Department Calling Group remains busy past the DISA No Answer Time, the DISA call routes to the overflow destination or disconnects. (What happens to the unanswered call is set by the DISA Operating Mode). The Overflow Message requires a VRS.



## Warning Tone for Long DISA Calls

You can set up the system to provide a warning tone to DISA callers that have been on a call too long. The warning tone can be just a reminder (which the caller can ignore) or can be followed by a forced disconnect of the call. When the DISA caller hears the warning tone, they have the option of dialing a code to continue the conversation or disconnect.

## Trunk Continue/Disconnect Codes

Users can use a Continue or Disconnect service code. The Continue service code extends the conversation for a programmed time. If the user enters the Disconnect service code, the call is immediately disconnected.

### EXAMPLE:

The following example indicates how a call will be handled with the system programmed as follows:

- Program 14-01-25: **1**
  - Program 20-28-01: **#**
  - Program 20-28-02: **No Setting**
  - Program 20-28-03: **180**
  - Program 24-02-07: **600** (Used only with manually transferred Tandem Trunk calls)
  - Program 24-02-10: **30** (Used only with manually transferred Tandem Trunk calls)
  - Program 25-07-07: **600** (Used only with automatically transferred Tandem Trunk calls or DISA calls)
  - Program 25-07-08: **30** (Used only with automatically transferred Tandem Trunk calls or DISA calls)
1. An external call connects to an external number (either by transferring with Tandem Trunking or by DISA caller).
  2. After 10 minutes (Tandem Trunking = Program 24-02-07 or DISA = Program 25-07-07), a warning tone is heard and the user dials **#** (Program 20-28-01) to extend the conversation.
  3. After three minutes (Program 20-28-03), the warning tone is heard again. After 30 seconds (Tandem Trunking = Program 24-02-10 or DISA = Program 25-07-08), the call is disconnected.

## Conditions

- The DISA caller must use an analog (DTMF) telephone. DISA is compatible with calling devices that meet the DTMF signaling requirements of EIA Specification RS-464. DISA trunks must be ground start or supervised loop start.
- The Continue/Disconnect code must be DTMF.
- With an analog trunk, the Continue/Disconnect code may work using DTMF sounds from the opposite side trunk. With an ISDN trunk, Program 14-01-25 must be enabled to detect the Continue/Disconnect code.
- The Continue/Disconnect code is not accepted while dialing a trunk.

- Continue/Disconnect codes do not work if all DTMF receivers are busy.
- When used with the Networking feature, both systems must be programmed the same.
- In a system with ARS enabled:  
When a DISA caller dials 9 for an outside call (if allowed), the system routes the call via ARS.
- In a system with ARS disabled:  
When a DISA caller dials 9 for an outside call (if allowed), the system uses the routes programmed for Trunk Group Routing.
- Transferred calls on DISA, DID, DIL, ISDN trunks, or from the VRS can display the reason a call is being transferred (Call Forward, Busy, No Answer or DND).
- Long conversation cutoff is controlled separately for manually transferred Tandem Trunk calls, automatically transferred Tandem Trunk calls, and DISA calls.
- Tandem Trunking also uses the Continue/Disconnect codes DISA uses.
- Department Calling with Overflow Message requires a DSP daughter board for VRS.
- DISA can only be set to call forward to another extension. Call Forward Off-Premise is not supported.
- When the DISA/VRS Ring Group Transfer (Programs 25-03 and 25-04) are set to 104 (Speed Dial Bin), the Speed dial is treated as an internal call no matter what Program 13-01-01 is set to. If an outside number is required, the trunk access code must be put into the speed dial bin.
- Park Retrieve is not supported using DISA.
- Call Forwarding for a Virtual Extension cannot be set from DISA.

## Default Settings

Disabled

## System Availability

### Terminals

Remote Analog DTMF (2500 type) telephones

### Required Component(s)

InMail (for Announcements)

## Related Features

- ➔ **Automatic Route Selection (ARS)**
- ➔ **Central Office Calls, Answering**
- ➔ **Direct Inward Dialing (DID)**
- ➔ **Direct Inward Line (DIL)**
- ➔ **Long Conversation Cutoff**
- ➔ **Tandem Trunking (Unsupervised Conference)**
- ➔ **Transfer**
- ➔ **Voice Response System (VRS)**

## Guide to Feature Programming

The **Level 1**, **Level 2** and **Level 3** columns indicate the programs that are assigned when programming this feature in the order they are most commonly used. These levels are used with PCPro and WebPro wizards for feature programming.

- Level 1 – these are the most commonly assigned programs for this feature.
- Level 2 – these are the next most commonly assigned programs for this feature.
- Level 3 – these programs are not often assigned and require an expert level working knowledge of the system to be properly assigned.

Program Number	Program Name/Description	Input Data	Default	Level		
				1	2	3
10-09-01	<b>DTMF and Dial Tone Circuit Setup</b> Reserve at least one circuit for DTMF reception (entry 0 or 2). Use the following as a guide when allocating DTMF receivers: <ul style="list-style-type: none"> <li>○ In light traffic sites, allocate one DTMF receiver for every 10 devices that use them.</li> <li>○ In heavy traffic sites, allocate one DTMF receiver for every five devices that use them.</li> </ul>	0 = Common Use 1 = Extension Only 2 = Trunk Only	Circuit/Resource 01 ~ 08 = 1 (Extensions) Circuit/Resource 09 ~ 32 = 2 (Trunks) Circuit/Resource 33 ~ 144 = 0 (Common) When GPZ-BS10 is installed, 81 ~ 144 are available			✓
11-01-01	<b>System Numbering</b> Define the system numbering plan.		Refer to the Programming Manual for default values.			✓

Program Number	Program Name/Description	Input Data	Default	Level		
				1	2	3
11-09-02	<b>Trunk Access Code – 2nd Trunk Route Access Code</b> Assign the Service Code set up in Program 11-01 for 2nd (Alternate) Trunk Route Access.	Dial (maximum of four digits)	No Setting			✓
14-01-02	<b>Basic Trunk Data Setup – Transmit Level</b> Customize the transmit and receive levels of the CODEC Gain Types for each trunk.	Trunks 1 ~ 400 1 ~ 57 (-15.5 ~ +12.5dB in 0.5dB intervals)	32 (0dB)		✓	
14-01-03	<b>Basic Trunk Data Setup – Receive Level</b> Customize the transmit and receive levels of the CODEC Gain Types for each trunk.	Trunks 1 ~ 400 1 ~ 57 (-15.5 ~ +12.5dB in 0.5dB intervals)	32 (0dB)		✓	
14-01-13	<b>Basic Trunk Data Setup – Trunk-to-Trunk Transfer</b> If DISA caller can place outgoing calls through the system (refer to Program 20-14 in the <i>UNIVERGE SV9100 Programming Manual</i> ), Enable loop supervision for the DISA trunk. If DISA caller cannot use the system trunks for outgoing calls, enter Disable.	0 = Disable (No) 1 = Enable (Yes)	1		✓	
20-01-05	<b>System Options – DTMF Receive Active Time</b> After answering the call, the system attaches a DTMF receiver to the DISA trunk for this time.	0 ~ 64800 seconds	10			✓
20-06-01	<b>Class of Service for Extensions</b> Assign a Class of Service (1 ~ 15) to an extension.	Day Night/Mode: 1 ~ 8 Class of Service of Extensions (1 ~ 15)	Extension port 101 = Class 15 All other extension port = Class 1	✓		
20-09-01	<b>Class of Service Options (Incoming Call Service) – Second Call for DID/DISA/DIL/ E&amp;M Override</b> Turn Off or On an extension ability to receive a second call from a DID, DISA, DIL, or tie line caller.  ➡ <i>With this option set to 1, the destination extension must be busy for a second DNIS caller to ring through. If the destination extension does not have a trunk or CAP key available for the second call and a previous call is ringing the extension but has not yet been answered, the second caller hears busy regardless of this program setting.</i>	0 = Off 1 = On	COS 1 ~ 15 = 1		✓	
20-13-23	<b>Class of Service Options (Supplementary Service) – Display the Reason for Transfer</b> Select whether or not an extension should display the reason a call is being transferred to their extension (Call Forward Busy, Call Forward No Answer, DND).	0 = Off 1 = On	COS 1 ~ 15 = 0		✓	

Program Number	Program Name/Description	Input Data	Default	Level		
				1	2	3
20-14-01	<p><b>Class of Service Options for DISA/E&amp;M – First Digit Absorption (Delete First Digit Dialed)</b></p> <p>For tie lines, enable/disable the ability to ignore the first incoming digit. Use this to make the tie trunk compatible with 3- and 4-digit tie line service. This option does not apply to DISA.</p>	<p>0 = Off 1 = On</p>	COS 1 ~ 15 = 0	✓		
20-14-02	<p><b>Class of Service Options for DISA/E&amp;M – Trunk Group Routing/ARS Access</b></p> <p>Enable/Disable a DISA or tie trunk caller ability to dial 9 for Trunk Group Routing or Automatic Route Selection (ARS).</p>	<p>0 = Off 1 = On</p>	COS 1 ~ 15 = 1	✓		
20-14-03	<p><b>Class of Service Options for DISA/E&amp;M – Trunk Group Access</b></p> <p>Enable/Disable a DISA or tie trunk caller ability to access trunk groups for outside calls (Service Code 704).</p>	<p>0 = Off 1 = On</p>	COS 1 ~ 15 = 1	✓		
20-14-04	<p><b>Class of Service Options for DISA/E&amp;M – Outgoing System Speed Dial</b></p> <p>Enable/Disable a DISA or tie trunk caller ability to use System Speed Dialing.</p>	<p>0 = Off 1 = On</p>	COS 1 ~ 15 = 0	✓		
20-14-05	<p><b>Class of Service Options for DISA/E&amp;M – Operator Calling</b></p> <p>Enable/Disable a DISA or tie trunk caller ability to dial 0 for the telephone system operator.</p>	<p>0 = Off 1 = On</p>	COS 1 ~ 15 = 1	✓		
20-14-06	<p><b>Class of Service Options for DISA/E&amp;M – Internal Paging</b></p> <p>Enable/Disable a DISA or tie trunk caller ability to use the telephone system Internal Paging.</p>	<p>0 = Off 1 = On</p>	COS 1 ~ 15 = 1	✓		
20-14-07	<p><b>Class of Service Options for DISA/E&amp;M – External Paging</b></p> <p>Enable/Disable a DISA or tie trunk caller ability to use the telephone system External Paging.</p>	<p>0 = Off 1 = On</p>	COS 1 ~ 15 = 1	✓		
20-14-08	<p><b>Class of Service Options for DISA/E&amp;M – Direct Trunk Access</b></p> <p>Enable/Disable a DISA or tie trunk caller ability to use Direct Trunk Access (Service Code #9).</p>	<p>0 = Off 1 = On</p>	COS 1 ~ 15 = 0	✓		
20-14-09	<p><b>Class of Service Options for DISA/E&amp;M – Forced Trunk Disconnect &lt;Not for ISDN T-point&gt;</b></p> <p>Enable/Disable a tie trunk caller ability to use Forced Trunk Disconnect (Service Code 3). This option is not available to DISA callers.</p>	<p>0 = Off 1 = On</p>	COS 1 ~ 15 = 0	✓		
20-14-10	<p><b>Class of Service Options for DISA/E&amp;M – Call Forward Setting by Remote via DISA</b></p> <p>Enable/Disable a DISA caller ability to use the Call Forward service codes (Programs 11-11-01 ~11-11-05).</p>	<p>0 = Off 1 = On</p>	COS 1 ~ 15 = 0	✓		

Program Number	Program Name/Description	Input Data	Default	Level		
				1	2	3
20-14-11	<b>Class of Service Options for DISA/E&amp;M – DISA/Tie Trunk Barge-In</b> Enable/Disable a DISA or tie trunk user ability to use the Barge-In feature.	0 = Off 1 = On	COS 1 ~ 15 = 0	✓		
21-15-01	<b>Individual Trunk Group Routing for Extensions</b> Designate the trunk route accessed when a user dials the Alternate Trunk Route Access Code. Refer to Trunk Group Routing to set up outbound routing.	0 ~ 100 0 = No Setting (Calls will not route.)	0		✓	
22-01-11	<b>System Options for Incoming Calls – VRS Waiting Message Interval Time</b> Set up the duration time between announcing the VRS Waiting Message for Auto – Attendant & Queuing. The message is repeatedly sent out in the specified time.	0 ~ 64800 seconds	20		✓	
22-02-01	<b>Incoming Call Trunk Setup</b> For DISA operation, set the trunk service type to 2. You can have a different service type for each Night Service mode.	Incoming Type for Day/Night Mode (1 ~ 8): 0 = Normal 1 = VRS (second dial tone if no VRS installed) 2 = DISA 3 = DID 4 = DIL 5 = E&M Tie line 6 = Delayed VRS 7 = ANI/DNIS 8 = DID(DDI) Mode Switching	0	✓		
22-04-01	<b>Incoming Extension Ring Group Assignment</b> Assign the extensions that should receive the overflow. Set the ringing in Program 22-06.	Maximum of eight digits.	Extensions 101 ~ 108 (first eight ports) ring for incoming Ring Group 1 calls. No other extensions ring for incoming Ring Group 1 calls.		✓	
25-01-01	<b>VRS/DISA Line Basic Data Setup – VRS/DISA Dial-In Mode</b> Select whether the DISA trunk uses Extension number/Service code specify or Dial Conversion Table.	0 = Extension Number Service Code Specify (Intercom) 1 = Use Dial Conversion Table	0		✓	
25-01-02	<b>VRS/DISA Line Basic Data Setup – DISA User ID</b> Select whether or not the DISA User ID should be used.	0 = Off 1 = On	1	✓		

Program Number	Program Name/Description	Input Data	Default	Level		
				1	2	3
25-01-03	<b>VRS/DISA Line Basic Data Setup – VRS/DISA Transfer Alarm</b> Select whether or not the DISA transfer alarm should be used.	0 = Normal 1 = Alarm	0	✓		
25-01-04	<b>VRS/DISA Line Basic Setup – VRS/DISA Transfer Tone</b> Select VRS/DISA Transfer Tone as Inbound Tone sent to external caller while the VRS/DISA call is transferred.	0 = Ring Back Tone 1 = MOH	0		✓	
25-02-01	<b>DID/DISA VRS Message</b> Assign the source and VRS message number to be used as the Automated Attendant Message for each trunk (001 ~ 400) which is assigned as a VRS/DISA	0 = No Message 1 = VRS (01 ~ 100 VRS Message Number) 2 = ACI (01 ~ 04 ACI Group Number) 3 = Department Groups (01 ~ 64 Extension Group Number)	0	✓		
25-03-01	<b>VRS/DISA Transfer Ring Group With Incorrect Dialing</b> Set the operating mode of each DISA trunk. This sets what happens to the call when the DISA caller dials incorrectly. The call can either Disconnect (0), transfer to an alternate ring group destination, or transfer to In-Skin/ External Voice Mail, or Centralized Voice Mail.	Ring Groups: 1 ~ 100 Trunk Ports: 001 ~ 400 Day/Night Mode: 1 ~ 8 0 = Disconnect 1 ~ 100 = Incoming Ring Group 101 DSPDB-VM 102 = In-Skin/External Voice Mail or InMail 104 = Speed Dial Bin (table Program 25-15-01)	0	✓		
25-04-01	<b>VRS/DISA Transfer Ring Group With No Answer/Busy</b> Set the operating mode of each DISA trunk. This sets what happens to the call when the DISA caller calls a busy or unanswered extension. The call can either Disconnect (0), or transfer to an alternate ring group destination, In-Skin/External Voice Mail, or Centralized Voice Mail.	Ring Groups: 1 ~ 100 Trunk Ports: 001 ~ 400 Day/Night Mode: 1 ~ 8 0 (Disconnect) 1 ~ 100 (Incoming Ring Group) 102 (In-Skin/External Voice Mail or InMail) 104 (Speed Dial table Program 25-15-01)	0	✓		

Program Number	Program Name/Description	Input Data	Default	Level		
				1	2	3
25-05-01	<p><b>VRS/DISA Error Message Assignment</b></p> <p>Assign the VRS message number to be used as the Automated Attendant error message. For each VRS/DISA trunk that the VRS answers, enter the VRS message (1 ~ 100) the outside caller hears if they dial incorrectly. If you enter 0 (i.e., no error message), the call reroutes according to Program 25-03 and Program 25-04. For each trunk, you make a separate entry for each Night Service mode.</p>	0 ~ 100 (0 = No Setting)	0	✓		
25-06-01	<p><b>VRS/DISA One-Digit Code Attendant Setup – Next Attendant Message Number</b></p> <p>Set up single digit dialing through the VRS. This gives VRS callers single-key access to extensions, the company operator, Department Calling Groups and Voice Mail. For each VRS message set to answer outside calls (see Program 25-02 and Program 25-05), you specify:</p> <ul style="list-style-type: none"> <li>○ The digit the VRS caller dials (0 ~ 9, *, #). (Keep in mind that if you assign destinations to digits, outside callers cannot dial system extensions, starting with that digit.</li> <li>○ The destination reached (eight digits maximum) when the caller dials the specified digit.</li> </ul> <p>The destination can be an extension, a Department Calling pilot number or the Voice Mail master number. A one-digit code can be assigned for each Automated Attendant message.</p>	0 ~ 100 (0 = No Setting) 101 = Voice Mail Answers 104 = Refer to 25-04: VRS/DISA Transfer Ring Group with No Answer/ Busy 105 = Dial the other extension 106 = Record VRS	0		✓	
25-06-02	<p><b>VRS/DISA One-Digit Code Attendant Setup – Destination Number</b></p> <p>Set up single digit dialing for Automated Attendant callers. For each VRS Message programmed to answer outside calls, specify:</p> <ul style="list-style-type: none"> <li>○ The digit the Automated Attendant caller dials (1 ~ 12, where 10 = 0, 11 = * and 12 = #). (Keep in mind that if you assign destinations to digits three and four, outside callers cannot dial system extensions that begin with that digit.)</li> <li>○ The destination reached (four digits maximum) when the caller dials the single digit code.</li> </ul>	Maximum of eight digits	No Setting	✓		
25-07-01	<p><b>System Timers for VRS/DISA – VRS/DISA Dial Tone Time</b></p> <p>After answering the DISA trunk, the system waits this time for the caller to dial the first digit of the DISA password. If the caller fails to dial during this time, the system drops the call.</p>	0 ~ 64800 seconds	10		✓	



Program Number	Program Name/Description	Input Data	Default	Level		
				1	2	3
25-07-02	<p><b>System Timers for VRS/DISA – VRS/DISA No Answer Time</b></p> <p>A DISA caller can ring an extension for this time before the system sets the call as a Ring No Answer. After this time expires, the call follows the programmed Ring No Answer routing (set in Program 25-03 and 25-04).</p>	0 ~ 64800 seconds	0		✓	
25-07-03	<p><b>System Timers for VRS/DISA – Disconnect after VRS/DISA retransfer to IRG</b></p> <p>From DISA trunk, when the call may go to Incoming Ring Group (IRG) of Program 25-03/25-04. This setting determines the time the call is ringing in the IRG.</p>	0 ~ 64800 seconds	60		✓	
25-07-04	<p><b>System Timers for VRS/DISA – Calling Time to Automatic Answering Telephone Set</b></p> <p>Set the answering waiting time of the automatic answering extension when an incoming DID trunk call is received.</p>	0 ~ 64800 seconds	10		✓	
25-07-05	<p><b>System Timers for VRS/DISA – Duration Time for Guidance Message by Automatic Answering Telephone Set</b></p> <p>Set the announcement time of the automatic answering extension before an incoming DID trunk caller is disconnected.</p>	0 ~ 64800 seconds	10		✓	
25-07-06	<p><b>System Timers for VRS/DISA – Duration Time for Guidance Message by ACI</b></p> <p>Set the announcement time by the ACI after which an incoming DID trunk caller is disconnected.</p>	0 ~ 64800 seconds	10		✓	
25-07-07	<p><b>System Timers for VRS/DISA – Long Conversation Warning Tone Time</b></p> <p>Determine the time a DISA caller or any automatically transferred trunk-to-trunk (such as Tandem Trunking) conversation can talk before the Long Conversation tone is heard.</p>	0 ~ 64800 seconds	3600		✓	
25-07-08	<p><b>System Timers for VRS/DISA – Long Conversation Disconnect Time</b></p> <p>Determine the time the system waits before disconnecting a DISA or any automatically transferred trunk-to-trunk (such as Tandem Trunking) call after the Long Conversation tone is heard.</p>	0 ~ 64800 seconds	10		✓	
25-07-09	<p><b>System Timers for VRS/DISA – DISA Internal Paging Time</b></p> <p>Set the maximum time of an Internal Page placed by a DISA caller. If the Page continues longer than this time, the system terminates the DISA call.</p>	0 ~ 64800 seconds	30		✓	

Program Number	Program Name/Description	Input Data	Default	Level		
				1	2	3
25-07-10	<b>System Timers for VRS/DISA – DISA External Paging Time</b> Set the maximum time an External Page is placed by a DISA caller. If the Page continues longer than this time, the system terminates the DISA call.	0 ~ 64800 seconds	30		✓	
25-07-11	<b>System Timers for VRS/DISA – VRS/DISA Answer Delay Time</b> Set the time the system waits after receiving an incoming VRS/DISA call before the system automatically answers the call (0 ~ 64800 seconds).	0 ~ 64800 seconds	0		✓	
25-07-13	<b>System Timers for VRS/DISA – VRS/DISA Busy Tone Interval</b> If a DISA caller dials a busy extension (and Program 25-04 = 0), the system plays busy tone for this time before disconnecting.	0 ~ 64800 seconds	5		✓	
25-07-14	<b>System Timers for VRS/DISA –Delayed VRS Answer Time</b> Assign the delay time from switching from a normal incoming status to DID Mode. If this time is set to 0, the call switches to DID immediately.	0 ~ 64800 seconds	10			
25-08-01	<b>DISA User ID Setup – Password</b> For each DISA user, set the 6-digit password.	Dial (Six digits fixed) (0 ~ 9, *, #)	No Setting	✓		
25-09-01	<b>Class of Service for DISA Users</b> Assign a DISA Class of Service for each user. Assign the DISA Class of Service options in Program 20-14. The DISA Class of Service cannot be 0. Program 20-06 cannot be used to assign Class of Service to DISA trunks.	Day/Night Mode = 1 ~ 8 Function Class = 1 ~ 15	1	✓		
25-10-01	<b>Trunk Group Routing for DISA</b> Assign the Trunk Group Route chosen when a user places a DISA call to the system and dials 9. Set Trunk Group Routing in Program 14-06. Enable or disable DISA caller ability to dial 9 in Program 20-14-02. Assign a route to each DISA Class of Service (1 ~ 15). The system assigns a DISA Class of Service to a call based on the password the DISA caller dials.	Day/Night Mode = 1 ~ 8 Route Table Number = 0 ~ 100 (0 = No Setting)	1		✓	
25-11-01	<b>DISA Toll Restriction Class</b> If the system uses Toll Restriction, enter a Toll Restriction Class (1 ~ 15) for each DISA user (1 ~ 15). The system uses the Toll Restriction Class you enter in Program 21-05 and 21-06. The Toll Restriction Class assigned to a DISA call is based on the DISA Class of Service and user, which is determined by the password the caller dials. Program 21-04 cannot be used to assign Toll Restriction to DISA trunks.	Day/Night Mode = 1 ~ 8 Toll Restriction Class = 1 ~ 15	2		✓	

Program Number	Program Name/Description	Input Data	Default	Level		
				1	2	3
25-12-01	<b>Alternate Trunk Group Routing for DISA</b> Assign the trunk route that DISA Callers access if they dial the Alternate Trunk Route Access Code. Refer to <a href="#">Central Office Calls, Placing on page 2-230</a> for more information on setting up Alternate Trunk Route Access.	Day/Night Mode = 1 ~ 8 Route Table Number = 0 ~ 100 (0 = No Setting)	1		✓	
25-15-01	<b>DISA Transfer Target Setup – DISA Transfer Target Area at Wrong Dial</b> Used to assign a speed dial number when the wrong number is received.	Speed Dial bin number 0 ~ 9999	9999	✓		
25-15-02	<b>DISA Transfer Target Setup – DISA Transfer Target Area at No Answer or Busy</b> Used to assign a speed dial number when a dial tone times out and the target extension does not answer or is busy.	Speed Dial bin number 0 ~ 9999	9999	✓		
25-17-01	<b>VRS/DISA Attendant Message Service Setup – Transfer Ring Group at Wrong Dialing</b> Set the transfer destination for VRS, DID, DISA and DID mode switching Trunk. The destination can be a Ring Group, Voice Mail or Speed dial.	Attendant Message Number (1~100) 0 = Refer PRG 25-03 1 ~ 100 = Incoming Ring Group 102 = In-Skin/External Voice Mail or InMail 104 = Speed Dial Bin (Program 25-17-03)	0		✓	
25-17-02	<b>VRS/DISA Attendant Message Service Setup – Transfer Ring Group at No Answer/Busy</b> Set the transfer destination for VRS, DID, DISA and DID mode switching Trunk. The destination can be a Ring Group or Voice Mail and Speed dial.	Attendant Message Number (1~100) 0 = Refer PRG 25-04 1 ~ 100 = Incoming Ring Group 102 = In-Skin/External Voice Mail or InMail 104 = Speed Dial Bin (Program 25-17-04)	0		✓	
25-17-03	<b>VRS/DISA Attendant Message Service Setup – Transfer Target Area at Wrong Dialing</b> Assign a speed dial bin target number for wrong dialing/Dial tone timeout.	0 ~ 9999	9999	✓		
25-17-04	<b>VRS/DISA Attendant Message Service Setup – Transfer Target Area at No Answer or Busy</b> Assign a speed dial bin target number for the target extension no answer or busy.	0 ~ 9999	9999		✓	
25-18-01	<b>VRS/DISA Attendant Message Timer Setup – Dial Tone</b> After answering a VRS/DISA trunk, the system waits this time for the caller to dial the first digit.	0 ~ 64800	10	✓		

Program Number	Program Name/Description	Input Data	Default	Level		
				1	2	3
25-18-02	<b>VRS/DISA Attendant Message Timer Setup – No Answer Time</b> A VRS/DISA caller can ring an extension for this time before the system sets the call as a Ring No Answer.	0 ~ 64800	0	✓		
25-18-03	<b>VRS/DISA Attendant Message Timer Setup – Disconnect After VRS/DISA Retransfer to IRG</b> From VRS/DISA trunk, when the call may go to Incoming Ring Group (IRG) or speed dial of Program 25-17-02. This setting determines the time the call is ringing in the IRG or speed dial.	0 ~ 64800	60	✓		

**Trunk Continue/Disconnect Codes:**

Program Number	Program Name/Description	Input Data	Default	Level		
				1	2	3
14-01-25	<b>Basic Trunk Data Setup – Continued/ Discontinued Trunk-to-Trunk Conversation</b> When Program 24-02-10 is set to disconnect a trunk after the defined time, determine whether or not a user should be able to use the continue/disconnect code.	0 = Disable (No) 1 = Enable (Yes)	0		✓	
20-28-01	<b>Trunk to Trunk Conversation – Conversation Continue Code</b> When Program 14-01-25 is enabled, determine the 1-digit code the user should dial (0 ~ 9, *, #) to extend the conversation for the time defined in Program 20-28-03. If the Continue and Disconnect codes are programmed the same (e.g., #), the system follows the Continue operation. Using the Continue code before the warning tone is heard has no action.	0 ~ 9, #, *	No Setting		✓	
20-28-02	<b>Trunk to Trunk Conversation – Conversation Disconnect Code</b> When Program 14-01-25 is enabled, determine the 1-digit code the user should dial (0 ~ 9, *, #) to immediately disconnect their call. Using the Disconnect code before the warning tone is heard disconnects the call.	0 ~ 9, #, *	No Setting		✓	
20-28-03	<b>Trunk to Trunk Conversation – Conversation Continue Time</b> When Program 14-01-25 is enabled, determine the time a call is extended when the user dials the Continue code (defined in Program 20-28-01).	0 ~ 64800 seconds	0		✓	

Program Number	Program Name/Description	Input Data	Default	Level		
				1	2	3
22-07-01	<p><b>DIL Assignment</b></p> <p>Assign the master/pilot number of the voice mail group from Program 11-07-01 as the DIL destination. If all Voice Mail ports are in the same unique Extension (Department) Group (see Program 16-02 above), the DIL rings another Voice Mail port if its assigned port is busy.</p> <p>➤ For this selection to work, set Program 22-02-01 to 4 (DIL).</p>	<p>Day/Night Modes (1 ~ 8):</p> <p>Extension Number (maximum of eight digits)</p> <p>Pilot Number</p>	No Setting	✓		
24-02-07	<p><b>System Options for Transfer – Trunk-to-Trunk Transfer Release Warning Tone</b></p> <p>This timer starts when a trunk begins talking with another trunk (for example: Trunk-to-Trunk Transfer/Tandem Trunking). When this time expires, a warning tone is heard. If Program 24-02-10 is set, the conversation disconnects after that time expires. This timer is set again when the external digit time expires. One of the trunks used must be an analog trunk (or leased line).</p> <p>➤ This applies to manually transferred Tandem Trunk and DISA calls.</p>	0 ~ 64800 seconds	1800		✓	
24-02-10	<p><b>System Options for Transfer – Disconnect Trunk-to-Trunk</b></p> <p>Determine the time a conversation continues after the time in Program 24-02-07 expires. If this option is set to 0, the conversation is disconnected immediately. This program has no affect if Program 24-02-07 is set to 0. One of the trunks used must be an analog trunk (or leased line).</p> <p>➤ This applies to manually transferred Tandem Trunk and DISA calls.</p>	0 ~ 64800 seconds	0		✓	
25-07-07	<p><b>System Timers for VRS/DISA – Long Conversation Warning Tone Time</b></p> <p>Determine the time the system waits before disconnecting a DISA or any automatically transferred trunk-to-trunk (such as Tandem Trunking) call after the Long Conversation tone is heard.</p> <p>If Program 25-07-08 is set to 0, the call is disconnected after the time expires. This timer is set again when the external digit time expires.</p> <p>➤ This applies to automatically transferred Tandem Trunk and DISA calls.</p>	0 ~ 64800 seconds	3600		✓	

Program Number	Program Name/Description	Input Data	Default	Level		
				1	2	3
25-07-08	<p><b>System Timers for VRS/DISA – Long Conversation Disconnect Time</b></p> <p>Determine the time the system waits before disconnecting a DISA or any automatically transferred trunk-to-trunk (such as Tandem Trunking) call after the Long Conversation tone is heard.</p> <p>This program has no affect if Program 25-07-07 is set to 0.</p> <p>➔ <i>This applies to automatically transferred Tandem Trunk and DISA calls.</i></p>	0 ~ 64800 seconds	10		✓	

## Operation

### To place a DISA call into the system (from any 2500 type telephone):

1. Dial the telephone number that rings the DISA trunk.
2. Wait for the DISA trunk to automatically answer with a unique dial tone.
3. Dial the 6-digit DISA password (access code).
4. Wait for a second unique dial tone.
5. Dial an extension.

- OR -

Dial **9** for Trunk Group Routing or ARS.

- OR -

Dial Alternate Trunk Route Access Code (if enabled).

- OR -

Dial **704** + a trunk group number (**1~100**) for an outside call.

- OR -

Dial **#9** + a trunk number (**1~400**) for an outside call.

- OR -

Dial **#2** + System Speed Dialing bin number.

- OR -

Dial **0** for the operator.

- OR -

Dial **701** + an Internal Paging Zone number (**0, 1~9, 00, 01~64**).

- OR -

Dial **703** + an External Paging Zone number (**1~8** or **0** for All Call).

- OR -

Dial **710** + a busy extension number to barge in to a call.

**To forward extension calls using a DISA call into the system (from any 2500 type telephone):**

1. Dial the telephone number that rings the DISA trunk.
2. Wait for the DISA trunk to automatically answer with a unique dial tone.
3. Dial the 6-digit DISA password (access code).
4. Wait for a second unique dial tone.
5. Dial the Call Forward service code (as defined in Program 11-11-01 through Program 11-11-05).
6. Dial the number of the extension to be forwarded.
7. Dial **1** to set Call Forwarding or **0** to cancel Call Forwarding.
8. Dial the extension number to which the calls will be forwarded.

**To use the Continue code to extend a DISA call:**

1. An external call connects to an external number (either by transferring with Tandem Trunking or by DISA caller).
2. After the programmed time (Program 25-07-07), a warning tone is heard and the user dials the Continue code (Program 20-28-01) to extend the conversation.
3. After the programmed time (Program 20-28-03), the warning tone is heard again. After the programmed time (Program 25-07-08), the call is disconnected if the Continue code is not dialed again.

## Direct Station Selection (DSS) Console

### Description

The DSS Console gives a multiline terminal user a Busy Lamp Field (BLF) and one-button access to extensions, trunks, and system features. This saves time for users that do a lot of call processing (e.g., attendants, operators, or dispatchers). The DSS Console simplifies:

- Calling extensions and door boxes
- Placing, answering and transferring outside calls
- Making an External or Internal Page
- Switching the Night Service mode
- Activating DSS Console Alternate Answer



The DSS Console also provides DSS Console Alternate Answer. This lets a multiline terminal user with a DSS Console quickly reroute their calls to a co-worker. Transferred and dial 0 calls ring both DSS Consoles and, if the VRS is installed, the main operator hears the message, "Your calls have been forwarded". Central office calls ring both consoles and no message is heard by the operator.

You can also program the DSS Console keys to store Service Codes (up to 29 digits long). This provides the DSS Console user with many of the features available on One-Touch and Programmable Feature Keys. The DSS Console keys can optionally store additional associated digits after the Service Code. For example, storing 70401 under a DSS Console key accesses Trunk Group 1 when the console user presses the key.

The maximum number of consoles allowed per system is 32. If a Digital Port Connection is used, one telephone can support a maximum of 32 DSS Consoles. If connected to an IP phone as a side option, a maximum of one DSS Console is supported per telephone.

### **DSS Lamp Table Changed to Apply to DSS/Hotline Keys for Multiline Terminals**

Using Programs 30-05-02~30-05-21 DSS Console Lamp Table, you can assign LED flash patterns for DSS and Hotline keys on multiline terminals and DSS Consoles.

### **ACD/Non-ACD Agent DSS Lamping Available**

With the UNIVERGE SV9100 system, Programs 30-05-02~30-05-21 allow a non-ACD DSS console to light indicating the status of both non-ACD agents and ACD agents, but ACD agents do not show ACD status (Logged In/Out, etc.), only idle, busy, etc.



## Conditions

- Changing flash patterns for DSS Consoles also changes them for Hotline keys.
- When installing a DSS, the system must auto-detect the console for the LEDs to function correctly. When connecting the DSS to an extension previously defined with another circuit type, undefine the circuit type (enter 00 in Program 10-03-01 for the extension number), then connect the DSS Console.
- Programmable Function Keys for ACD codes (\*10, \*12, \*13, \*14, \*15, \*16, \*17, \*18, \*19) cannot be programmed on a DSS Console.
- Programmable Function keys for Trunk Group (\*02), Virtual Extension (\*03), and Call Appearance (CAP) Key (\*08) cannot be programmed on a DSS Console as the system does not allow entry of the additional data required for these keys.
- A user can use the One-Touch Programmable Function Key (code 01) to have DSS Console keys for Personal Speed Dial and common and group Speed Dial.
- Lighting status for ACD agents and non-ACD agents does not appear on the same console type. For ACD agent's lighting status, a DSS Console must be programmed as a ACD console in Program 30-01-01. For non-ACD agents, the console must be programmed as a business console.
- A DSS key indicates only a Call Forwarding indication for extensions forwarded with Immediate Call Forwarding.
- A DSS Console can have line keys for placing and answering calls.
- The DSS Console provides one-touch calling and a Busy Lamp Field for Door Boxes. Refer to [Door Box on page 2-479](#) when programming Door Boxes.
- The DSS Console provides one-touch Night Service switching. Refer to [Night Service on page 2-1226](#) when programming Night Service options.
- Like a One-Touch Key, a user can have DSS Console keys for Direct Station Selection, Trunk Calling, Personal Speed Dial, Speed Dialing, and Service Code access.
- The DSS Console provides one-touch External and Internal Page zone access. Refer to [Paging, External on page 2-1257](#) and [Paging, Internal on page 2-1267](#).
- You can program the DSS Console keys with service codes to provide the functions of many of the Programmable Function keys. The stored service code can have up to three digits, but it can have additional option codes added (e.g. to set Immediate Call Forward for all calls. Trunk Group (\*02), Virtual Extension (\*03), and Call Appearance (CAP) Key (\*08) codes can not be programmed on a DSS Console as the system does not allow entry of the additional data required.
- The capacity of a console can be expanded by assigning a Page key (shift key). The Page key (shift key) must be assigned on keys 55~60.
- The expanded capacity for DSS Consoles (two pages), is not supported for DSS Consoles in the ACD Monitor Mode.

- When a multiline terminal user is on a call, they can transfer to another station by pressing a DSS key for that station. It is not necessary to press Transfer to transfer to another station using a DSS key.
  - ◇ *When a multiline terminal user is on a call, they must press Transfer to transfer a call off site with a DSS key.*
- Pauses can be entered in the dial string of a DSS/One Touch button. The pause is entered as P in the dial string and causes the system to wait three seconds before sending the rest of the digits that follow the P (pause). Multiple pauses can be entered.
- The @ can be entered in the dial string of a DSS/One Touch button. The @ only applies to ISDN and Intercom calls. When using the @, the system waits for the destination to answer (answer supervision), and then sends the rest of the digits.
- Entering a P (pause) in a DSS/One Touch dial string can be used for CO calls, Intercom calls, or after the @ for ISDN calls.
- When the system has the Hotel Motel license (0007), the Message Waiting Indication (MWI) on a DSS Console for an extension is a Green LED. Without the Hotel Motel license the MWI on a DSS Console for an extension is a Red LED.

### Default Settings

- No DSS Consoles assigned (in Program 30-02-01).
- All DSS Console key ranges are ports 1~200.
- Once a DSS Console is enabled, the console keys are DSS keys (Program 30-03-01).

## System Availability

### Terminals

All Multiline Terminals

### Required Component(s)

None

## Related Features

- ➔ **Call Forwarding**
- ➔ **Central Office Calls, Answering**
- ➔ **Central Office Calls, Placing**
- ➔ **Contact Center**

- ➔ **Door Box**
- ➔ **Night Service**
- ➔ **One-Touch Calling**
- ➔ **Paging, External**
- ➔ **Paging, Internal**
- ➔ **Programmable Function Keys**
- ➔ **Speed Dial – System/Group/Station**

## Guide to Feature Programming

The **Level 1**, **Level 2** and **Level 3** columns indicate the programs that are assigned when programming this feature in the order they are most commonly used. These levels are used with PCPro and WebPro wizards for feature programming.

- Level 1 – these are the most commonly assigned programs for this feature.
- Level 2 – these are the next most commonly assigned programs for this feature.
- Level 3 – these programs are not often assigned and require an expert level working knowledge of the system to be properly assigned.

◇ *The items highlighted in gray are read only and cannot be changed.*

Program Number	Program Name/Description	Input Data	Default	Level		
				1	2	3
<b>10-03-01</b>	<b>ETU Setup (DLCA PKG Setup) – Terminal Type (B1)</b> Set up and confirm the Basic Configuration data for terminal type (B1).	0 = Not set 1 = Multiline Terminal 3 = Bluetooth Cordless Handset 6 = PGD (Paging) 7 = PGD (Tone Ringer) 8 = PGD (Doorbox) 9 = PGD (ACI) 10 = DSS Console 11 = -- Not Used --	0	✓		
<b>15-02-08</b>	<b>Multiline Telephone Basic Data Setup – Automatic Handsfree</b> Set to 1 for a DSS Console to have one-touch operation. If set to 0, the user must lift the handset before pressing a DSS key for the call to complete.	0 = Preselect 1 = One-Touch (Automatic Handsfree)	1		✓	
<b>20-06-01</b>	<b>Class of Service for Extensions</b> Assign Class of Service (1 ~ 15) to extensions.	Day Night/Mode: 1 ~ 8 Class of Service of Extensions (1 ~ 15)	Extension port 101 = Class 15 All other extension port = Class 1	✓		

Program Number	Program Name/Description	Input Data	Default	Level		
				1	2	3
20-13-06	<b>Class of Service Options (Supplementary Service) – Automatic Off-Hook Signaling (Automatic Override)</b> Allow a busy extension user to Manually (0) or Automatically (1) receive off-hook signals. ➤ This setting is to receive incoming call signaling information during call queuing.	0 = Off 1 = On	COS 1 ~ 15 = 1		✓	
20-13-49	<b>Class of Service Options (Supplementary Service) – BLF Indication on CO Incoming State</b> Determine if a BLF of the station lights when a Normal CO call is ringing the phone.	0 = Off 1 = On	COS 1 ~ 15 = 0		✓	
20-17-01	<b>Operator Extension – Operator’s Extension Number</b> Define the extension numbers which are to be used by operators.	Maximum of eight digits	101		✓	
30-01-01	<b>DSS Console Operating Mode</b> Set the mode of the system DSS Consoles. The available options are Regular (Business) Mode (0), Hotel Mode (1), Monitor Mode (2) or Business/ Mode (3).	0 = Business Mode 1 = Hotel Mode 2 = Monitor Mode 3 = Business/ Mode	0		✓	
30-02-01	<b>DSS Console Extension Assignment – Extension Number</b> Enter the extension number for the multiline terminal connected with the DSS console (up to eight digits).	Maximum of eight digits	No Setting	✓		
30-03-01	<b>DSS Console Key Assignment</b> Customize DSS Console keys to function as DSS keys, Service Code keys, Programmable Function Keys, and One-Touch Calling keys. The key [when defined as a DSS/One-Touch key (code 01)] can have any function up to four digits (e.g., extension number or Service Code). The function information (such as extension number or Service Code) would then be entered as the additional data.	Key Number 001 ~ 114 0 ~ 99 (General Functional Level) 97 = Door Box Access key (additional data: 1 ~ 8 Door Box No.) * 00 ~ * 99 (Appearance Functional Level)	Refer to the Programming Manual for default values.	✓		
30-04-01	<b>DSS Console Alternate Answer</b> Define the DSS Console Alternate answer number.	Alternate DSS No. 01 ~ 32	No Setting		✓	
30-05-02	<b>DSS Console Lamp Table – Busy Extension</b> Define the LED patterns for busy extensions on the DSS consoles.	0 ~ 7	7 (On)		✓	
30-05-03	<b>DSS Console Lamp Table – DND Extension</b> Define the LED patterns for busy DND extensions on the DSS consoles.	0 ~ 7	3 (RW)		✓	
30-05-04	<b>DSS Console Lamp Table – Agent Busy</b> Define the LED patterns for busy agents on the DSS consoles.	0 ~ 7	7 (On)		✓	

Program Number	Program Name/Description	Input Data	Default	Level		
				1	2	3
30-05-05	<b>DSS Console Lamp Table – Out of Schedule (DSS)</b> Define the LED patterns for out of schedule (/ DSS) on the DSS consoles.	0 ~ 7	0 (Off)		✓	
30-05-06	<b>DSS Console Lamp Table – Agent Log Out (DSS)</b> Define the LED patterns for agents that are logged out on the DSS consoles.	0 ~ 7	5 (IL)		✓	
30-05-07	<b>DSS Console Lamp Table – Agent Log In (DSS)</b> Define the LED patterns for agents that are logged in on the DSS consoles.	0 ~ 7	4 (IR)		✓	
30-05-08	<b>DSS Console Lamp Table – Agent Emergency (DSS)</b> Define the LED patterns for agent using emergency on the DSS consoles.	0 ~ 7	6 (IW)		✓	
30-05-09	<b>DSS Console Lamp Table – Hotel Status Code 1 (Hotel DSS)</b> Define the LED patterns for hotel status code 1 on the DSS consoles.	0 ~ 7	7 (On)		✓	
30-05-10	<b>DSS Console Lamp Table – Hotel Status Code 2 (Hotel DSS)</b> Define the LED patterns for hotel status code 2 on the DSS consoles.	0 ~ 7	1 (FL)		✓	
30-05-11	<b>DSS Console Lamp Table – Hotel Status Code 3 (Hotel DSS)</b> Define the LED patterns for hotel status code 3 on the DSS consoles.	0 ~ 7	2 (WK)		✓	
30-05-12	<b>DSS Console Lamp Table – Hotel Status Code 4 (Hotel DSS)</b> Define the LED patterns for hotel status code 4 on the DSS consoles.	0 ~ 7	3 (RW)		✓	
30-05-13	<b>DSS Console Lamp Table – Hotel Status Code 5 (Hotel DSS)</b> Define the LED patterns for hotel status code 5 on the DSS consoles.	0 ~ 7	5 (IL)		✓	
30-05-14	<b>DSS Console Lamp Table – Hotel Status Code 6 (Hotel DSS)</b> Define the LED patterns for hotel status code 6 on the DSS consoles.	0 ~ 7	3 (RW)		✓	
30-05-15	<b>DSS Console Lamp Table – Hotel Status Code 7 (Hotel DSS)</b> Define the LED patterns for hotel status code 7 on the DSS consoles.	0 ~ 7	6 (IW)		✓	

Program Number	Program Name/Description	Input Data	Default	Level		
				1	2	3
30-05-16	<b>DSS Console Lamp Table – Hotel Status Code 8 (Hotel DSS)</b> Define the LED patterns for hotel status code 8 on the DSS consoles.	0 ~ 7	4 (IR)		✓	
30-05-17	<b>DSS Console Lamp Table – Hotel Status Code 9 (Hotel DSS)</b> Define the LED patterns for hotel status code 9 on the DSS consoles.	0 ~ 7	3 (RW)		✓	
30-05-18	<b>DSS Console Lamp Table – Hotel Status Code 0 (Hotel DSS)</b> Define the LED patterns for hotel status code 0 on the DSS consoles.	0 ~ 7	0 (Off)		✓	
30-05-19	<b>DSS Console Lamp Table – Hotel Status Code * (Hotel DSS)</b> Define the LED patterns for hotel status code * on the DSS consoles.	0 ~ 7	4 (IR)		✓	
30-05-20	<b>DSS Console Lamp Table – Hotel Status Code # (Hotel DSS)</b> Define the LED patterns for hotel status code # on the DSS consoles.	0 ~ 7	5 (IL)		✓	
30-05-21	<b>DSS Console Lamp Table – VM Message Indication</b> Define the LED patterns for VM message indications on the DSS consoles.	0 ~ 7	3 (RW)		✓	
30-10-01	<b>DSS Console IP Terminal Setup – MAC Address</b> Read Only program that displays the MAC address of the IP terminal associated with a DSS console.	00-00-00-00-00-00 ~ FF-FF-FF-FF-FF-FF	00-00-00-00-00-00		✓	

## Operation

### Calling an extension from your DSS Console:

1. Press the **DSS Console** key.
  - ◇ *If the call voice-announces, you can make it ring by dialing 1.*
  - ◇ *If you do not have Handsfree, you must lift the handset to speak.*

Extension Busy Lamp Field	
When the DSS key is...	The assigned extension is...
On	Busy on a call
Off	Idle
Flashing Fast	In Do Not Disturb

### Answering a trunk call from your DSS Console:

1. Press the flashing **DSS Console** key assigned to the trunk.
  - ◇ *If you do not have Handsfree, you must lift the handset to speak.*

### Transferring a call using your DSS Console:

1. Place or answer the call.
2. Press **Transfer** to transfer the call.
3. Press the DSS key for the extension to receive the transfer.
4. (Optional) Announce the call.
  - ◇ *If called party does not want the call, press the flashing line key to retrieve it.*

### Making an External Page using your DSS Console:

1. Press the **DSS Console External Page** zone key (1~8).
  - ◇ *If the zone you want is busy, try again later.*
  - ◇ *If you do not have Handsfree, lift the handset to make your announcement.*

External Page Busy Lamp Field	
When the DSS key is...	The External Page zone is...
On	Busy
Off	Idle

### Making an Internal Page using your DSS Console:

1. Press the **DSS Console Internal Page** zone key (Group key 1~64).
  - ◇ *If the zone you want is busy, try again later.*
  - ◇ *If you do not have Handsfree, lift the handset to make your announcement.*

Internal Page Busy Lamp Field	
When the DSS key is...	The Internal Page zone is...
On	Busy
Off	Idle

### Switching the Night Service mode from your DSS Console:

1. Press the Night Service key.

Night Service Busy Lamp Field	
When this key is ON...	The system is in the...
DAY	Day 1 Mode
NIGHT	Night 1 Mode
BREAK	Break 1 Mode
NIGHT 2	Night 2 Mode

### Using a DSS Console key as a One-Touch or Programmable Function Key:



NOTE

*A user can have DSS Console keys programmed as One-Touch Keys. These keys can be used for Direct Station Selection, Trunk Calling, Personal Speed Dial, Speed Dialing, and Service Code access. The stored service code cannot be longer than three digits.*

1. Press the **DSS Console** key for function.
  - ◇ *For example, you can forward your calls by pressing **DSS** key + 1 + destination. Your DSS key must have been previously programmed for Call Forward.*



## *Distinctive Ringing, Tones and Flash Patterns*

### Description

Distinctive Ringing, Tones and Flash Patterns provide extension users with audible and visual call status signals. This lets users tell the type of calls by listening to the ringing/tones and watching the keys. It also helps users monitor the progress of their calls. In addition, Distinctive Ringing lets multiline terminal users customize their Intercom and trunk call ringing. This is helpful for users that work together closely. For example, if several co-workers set their multiline terminals to ring at different pitches, each co-worker can always tell which calls are for them. You can also customize the tones the system uses for splash tone, confirmation tone, trunk ring tone, Intercom ring tone and Alarm ring tone. Refer to the UNIVERGE SV9100 Programming Manual for more details.

*Table 2-18 Distinctive Ringing: Tones and Flash Patterns*

Program	Description
80-01-01~04 Service Tone Setup	Set the frequency of the system splash tone. This is the tone the system uses, for example, to alert the user of an incoming voice-announced Intercom call.
30-05-02~21 DSS Console Lamp Table	Set the DSS and Hotline key flash rates for busy, idle, DND, Agent status, and hotel options.

### Conditions

- Single line telephone users cannot listen to or hear the pitch of the telephone incoming ring.
- If Program 22-03-01 is set to 0~3 or 9~12 and Program 15-02-02 is set to 1~3, trunk calls follow the ring pattern in Program 22-03-01 and the pitch in Program 15-02-02.
- If Program 22-03-01 is set to 4~8 and Program 15-02-02 is set to 1~3, trunk calls follow the ring pattern in Program 22-03-01.
- If Program 22-03-01 is set to 0~12 and Program 15-02-02 is set to 4~8, trunk calls follow the ring pattern in Program 15-02-02.
- If Program 15-08 : Incoming Virtual Extension Ring Tone Setup is set to Incoming Ring Tone Extension, then Program 15-10 : Incoming Virtual Extension Ring Tone Order Setup must have one of the priorities set to Incoming Ring Tone Extension.
- The following voice mail features require system tones be changed in Program 80-01-02 to work. Refer to the Programming section of the InMail feature for details.
  - Call Holding
  - Busy Greeting
  - Call Screening
  - Await Answer Transfer
- When a ring group call rings a Single Line Station, the BLF indication shows busy.

- The priority of the Large LED is as follows:
  1. CO Call Ringing
  2. Message Waiting Received
  3. VM Message Waiting
  4. Message Waiting Set
- The SV9100 supports a total of eight Tone Patterns.
- Program 15-08 is only effective for Virtual Extensions appearing on a station when the station is set for patterns 1~3 in Program 15-02-02. When Program 15-02-02 for the station is set to patterns 4~8, Program 15-08 for Virtual Extensions is not used.

Figure 2-18 Trunk Distinctive Ringing Flow Chart

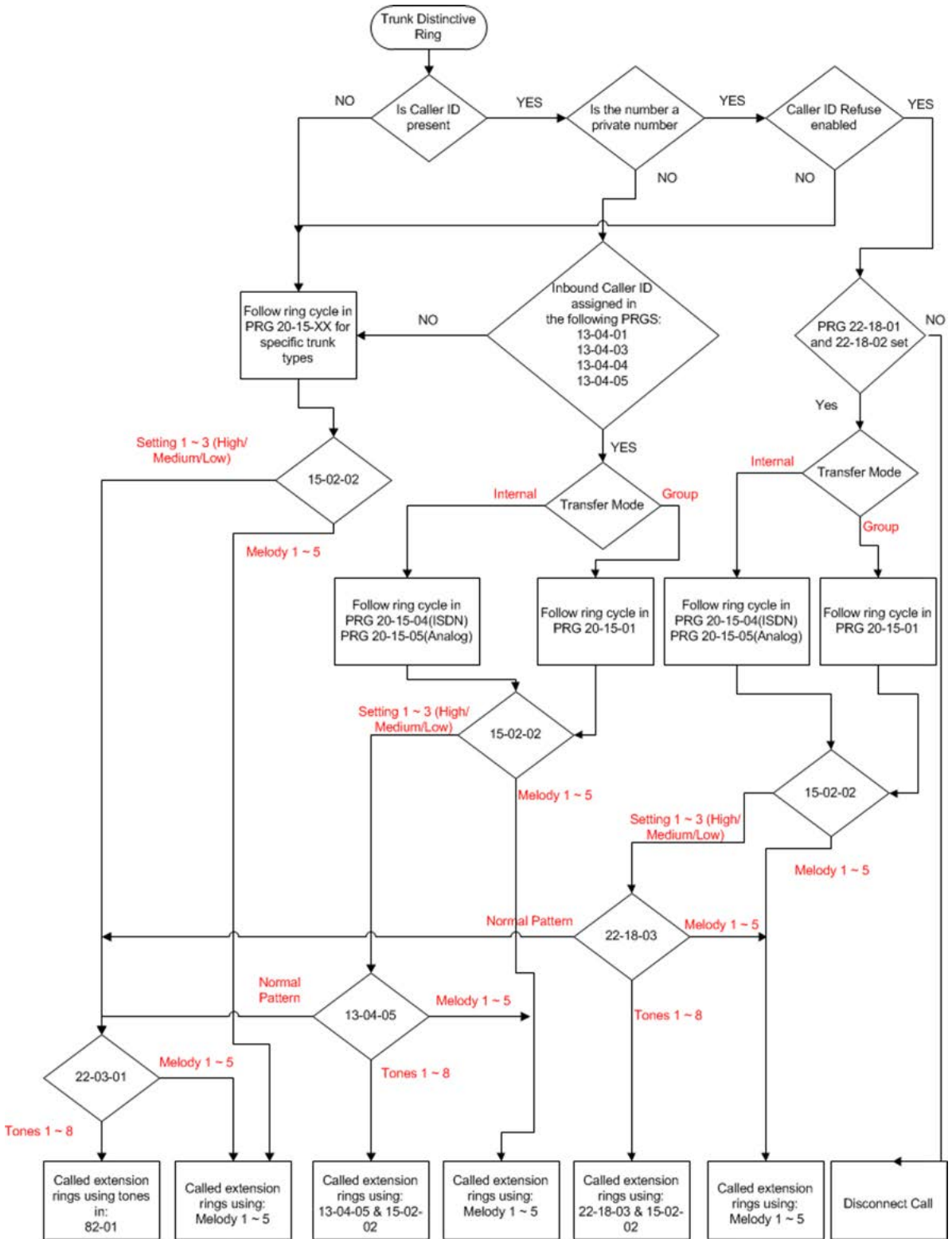
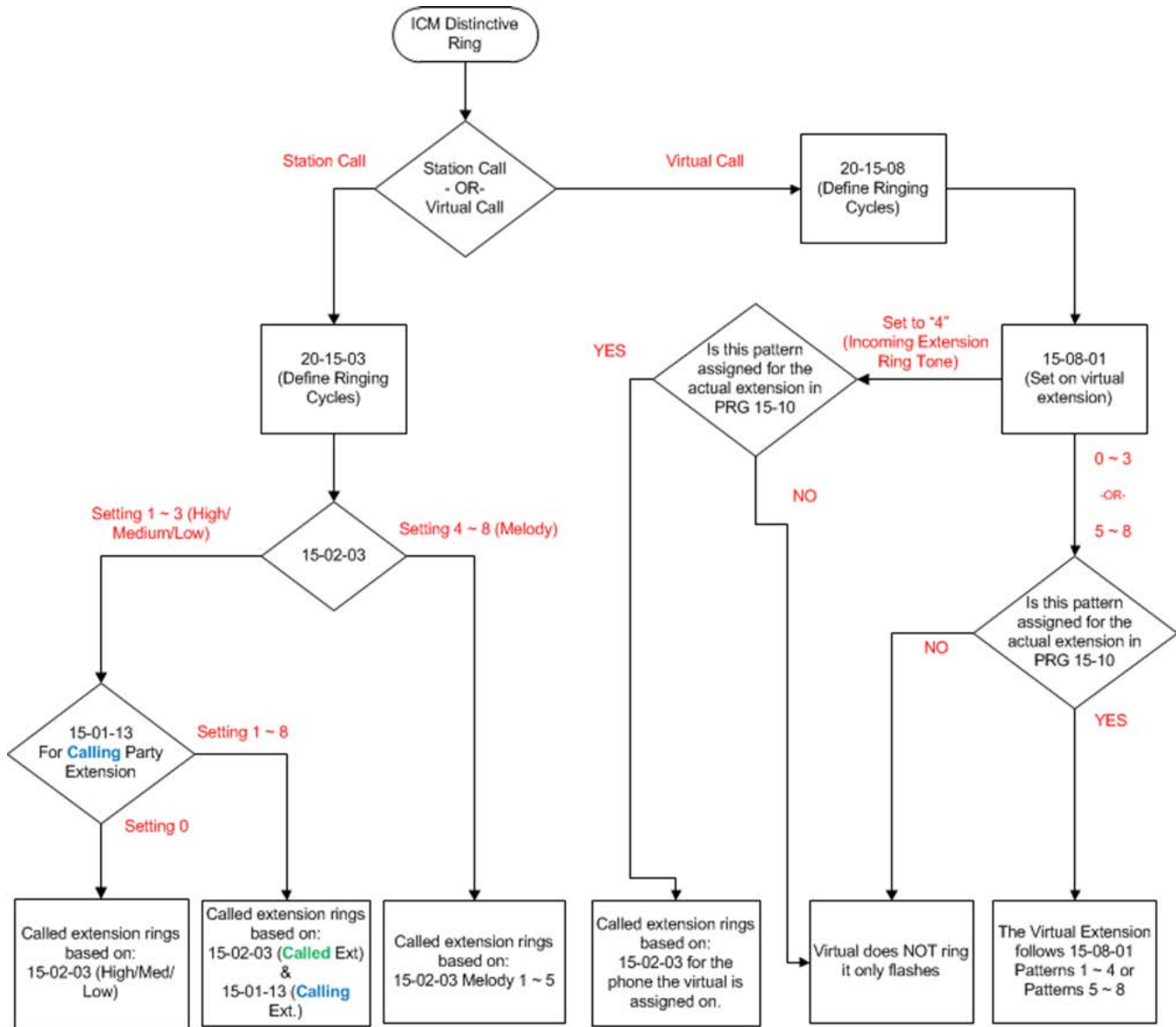

Figure 2-19 ICM Distinctive Ringing Flow Chart



## Default Settings

Enabled

## System Availability

### Terminals

All Multiline Terminals

### Required Component(s)

None

## Related Features

- ↳ [Call Arrival \(CAR\) Keys](#)
- ↳ [Single Line Telephones, Analog 500/2500 Sets](#)

## Guide to Feature Programming

The **Level 1**, **Level 2** and **Level 3** columns indicate the programs that are assigned when programming this feature in the order they are most commonly used. These levels are used with PCPro and WebPro wizards for feature programming.

- Level 1 – these are the most commonly assigned programs for this feature.
- Level 2 – these are the next most commonly assigned programs for this feature.
- Level 3 – these programs are not often assigned and require an expert level working knowledge of the system to be properly assigned.

Program Number	Program Name/Description	Input Data	Default	Level		
				1	2	3
15-02-02	<b>Multiline Telephone Basic Data Setup – Trunk Ring Tone</b> From the range specified in Program 22-03-01, select the multiline terminal extension trunk ring tone.	1 = High 2 = Medium 3 = Low 4 = Ring Tone 1 5 = Ring Tone 2 6 = Ring Tone 3 7 = Ring Tone 4 8 = Ring Tone 5	2		✓	
15-02-03	<b>Multiline Telephone Basic Data Setup – Extension Ring Tone</b> Select the extension intercom ring tone.	1 = High 2 = Medium 3 = Low 4 = Ring Tone 1 5 = Ring Tone 2 6 = Ring Tone 3 7 = Ring Tone 4 8 = Ring Tone 5	8		✓	

Program Number	Program Name/Description	Input Data	Default	Level		
				1	2	3
15-02-35	<b>Multiline Telephone Basic Data Setup – Message Waiting Lamp Cycle for Calling Extension</b> Select the cycle method that the Large LED flashes when the extension has set Message Waiting.	1 = Cycle 1 2 = Cycle 2 3 = Cycle 3 4 = Cycle 4 5 = Cycle 5 6 = Cycle 6 7 = Cycle 7	7		✓	
15-02-36	<b>Multiline Telephone Basic Data Setup – Message Waiting Lamp Cycle for Called Extension</b> Select the cycle method that the Large LED flashes when the extension has Message Waiting set to the extension.	1 = Cycle 1 2 = Cycle 2 3 = Cycle 3 4 = Cycle 4 5 = Cycle 5 6 = Cycle 6 7 = Cycle 7	3		✓	
15-02-37	<b>Multiline Telephone Basic Data Setup – Voice Mail Message Wait Lamp Color</b> Set up various message wait lamp cycle options for lamp color.	0 = Green 1 = Red	1		✓	
15-02-38	<b>Multiline Telephone Basic Data Setup – Voice Mail Message Wait Lamp Cycle</b> Select the cycle method that the Large LED flashes when the extension has a VM Message Waiting set to the extension.	1 = Cycle 1 2 = Cycle 2 3 = Cycle 3 4 = Cycle 4 5 = Cycle 5 6 = Cycle 6 7 = Cycle 7	3		✓	
15-08-01	<b>Incoming Virtual Extension Ring Tone Setup</b> Assign a ring tone range (0 ~ 8) to incoming virtual extensions assigned to a Virtual Extension key (Program 15-07).	ICM Tone Pattern, 0 = Pattern 1 1 = Pattern 2 2 = Pattern 3 3 = Pattern 4 4 = Incoming Extension Ring Tone 5 = Tone Pattern 5 6 = Tone Pattern 6 7 = Tone Pattern 7 8 = Tone Pattern 8	0			✓
15-10-01	<b>Incoming Virtual Extension Ring Tone Order Setup</b> When two or more virtual extensions are set on a function key on the telephone, and the tone pattern by which the sound of each extension differs, the priority of ring sound is set up.	0 = Tone Pattern 1 1 = Tone Pattern 2 2 = Tone Pattern 3 3 = Tone Pattern 4 4 = Incoming Extension Ring Tone 5 = Tone Pattern 5 6 = Tone Pattern 6 7 = Tone Pattern 7 8 = Tone Pattern 8	Order 1 Pattern 0 = Pattern 1 Order 2 Pattern 1 = Pattern 2 Order 3 Pattern 2 = Pattern 3 Order 4 Pattern 3 = Pattern 4			✓

Program Number	Program Name/Description	Input Data	Default	Level		
				1	2	3
20-13-49	<b>Class of Service Options (Supplementary Service) – BLF Indication on CO Incoming State</b> Determine if a BLF of the station lights when a Normal CO call is ringing the phone.	0 = Off 1 = On	COS 1 ~ 15 = 0		✓	
20-15-01	<b>Ring Cycle Setup – Normal Incoming Call on Trunk</b> Define the ringing cycle for Normal Incoming Trunk calls.	Ringling Cycle = 1 ~ 13	2		✓	
20-15-02	<b>Ring Cycle Setup – PBX, CES Incoming Call</b> Define the ringing cycle for PBX, CES incoming calls.	Ringling Cycle = 1 ~ 13	8		✓	
20-15-03	<b>Ring Cycle Setup – Incoming Internal Call</b> Define the ringing cycle for incoming Internal Calls.	Ringling Cycle = 1 ~ 13	12		✓	
20-15-04	<b>Ring Cycle Setup – DID/DISA/VRS</b> Define the ringing cycle for DID/DISA/VRS Calls.	Ringling Cycle = 1 ~ 13	8		✓	
20-15-05	<b>Ring Cycle Setup – DID/DDI</b> Define the ringing cycle for DID/DDI calls.	Ringling Cycle = 1 ~ 13	8		✓	
20-15-06	<b>Ring Cycle Setup – Dial-In in the E&amp;M Tie Line</b> Define the ringing cycle for Dial-In and E&M Tie Line calls.	Ringling Cycle = 1 ~ 13	12		✓	
20-15-07	<b>Ring Cycle Setup – Door Box Ringing for SLT</b> Define the ringing cycle for Door Box ringing for single line telephone.	Ringling Cycle = 1 ~ 13	8		✓	
20-15-08	<b>Ring Cycle Setup – Virtual Extension Ring</b> Define the ringing cycle for Virtual Extension Ringing.	Ringling Cycle = 1 ~ 13	8		✓	
20-15-09	<b>Ring Cycle Setup – Callback</b> Define the ringing cycle for Callback.	Ringling Cycle = 1 ~ 13	11		✓	
20-15-10	<b>Ring Cycle Setup – Alarm for SLT</b> Define the ringing cycle for Alarm for single line telephone.	Ringling Cycle = 1 ~ 13	5		✓	
20-15-11	<b>Ring Cycle Setup – VRS Waiting Message Incoming Call</b> Define the ringing cycle for Incoming VRS Waiting Message.	Ringling Cycle = 1 ~ 13	6		✓	

Program Number	Program Name/Description	Input Data	Default	Level		
				1	2	3
22-03-01	<b>Trunk Ring Tone Range</b> Set the ring tone range (1 ~ 9) for each trunk.	0 = Ring Tone Pattern 1 1 = Ring Tone Pattern 2 2 = Ring Tone Pattern 3 3 = Ring Tone Pattern 4 4 = Melody 1 5 = Melody 2 6 = Melody 3 7 = Melody 4 8 = Melody 5 9 = Ring Tone Pattern 5 10 = Ring Tone Pattern 6 11 = Ring Tone Pattern 7 12 = Ring Tone Pattern 8	0		✓	
80-01-01	<b>Service Tone Setup – Repeat Count</b> Customize the system basic tones and system service tones. You need to reset for the changes to take effect.	0 ~ 255 (0 = until On-Hook)	0~255 (0 = until On-Hook)			✓
80-01-02	<b>Service Tone Setup – Basic Tone Number</b> The following features require that the system tones listed below be changed to match the table. After changing these settings the chassis must be reset for the changes to take effect. ○ Call Screening ○ Call Holding ○ Busy Greeting ○ Await Answer Transfer	1 ~ 33 (0 = No Tone) (33 = Default Time Slot)	33 = Default Time Slot Refer to <a href="#">Table 2-19 Basic Tone Table – Tone 06</a> on page 2-477.			✓
80-01-02 (14)	<b>Service Tone Setup – Basic Tone Number</b> The following features require that the system tones listed below be changed to match the table. After changing these settings the chassis must be reset for the changes to take effect. ○ Call Screening ○ Call Holding ○ Busy Greeting ○ Await Answer Transfer		Refer to <a href="#">Table 2-20 Basic Tone Table – Tone 14</a> on page 2-477.			✓
80-01-02 (39)	<b>Service Tone Setup – Basic Tone Number</b> The following features require that the system tones listed below be changed to match the table. After changing these settings the chassis must be reset for the changes to take effect. ○ Call Screening ○ Call Holding ○ Busy Greeting ○ Await Answer Transfer		Refer to <a href="#">Table 2-21 Basic Tone Table – Tone 39</a> on page 2-477.			✓



Table 2-19 Basic Tone Table – Tone 06

Tone 06			
Unit	Basic Tone	Duration	Gain Level
1	11~480/620Hz -13/-13dB	300ms	32
2	0 - No Tone	300ms	32
3	0 - No Tone	0ms	
4	0 - No Tone	0ms	
5	0 - No Tone	0ms	
6	0 - No Tone	0ms	
7	0 - No Tone	0ms	
8	0 - No Tone	0ms	

Table 2-20 Basic Tone Table – Tone 14

Tone 14			
Unit	Basic Tone	Duration	Gain Level
1	10~440/480Hz -13/-13dB	1000ms	32
2	0 - No Tone	2100ms	32
3	0 - No Tone	0ms	
4	0 - No Tone	0ms	
5	0 - No Tone	0ms	
6	0 - No Tone	0ms	
7	0 - No Tone	0ms	
8	0 - No Tone	0ms	

Table 2-21 Basic Tone Table – Tone 39

Tone 39			
Unit	Basic Tone	Duration	Gain Level
1	12~440/620Hz -16dB	500ms	32
2	0 - No Tone	500ms	32
3	0 - No Tone	0ms	
4	0 - No Tone	0ms	
5	0 - No Tone	0ms	

Table 2-21 Basic Tone Table – Tone 39 (Continued)

Tone 39 (Continued)			
6	0 - No Tone	0ms	
7	0 - No Tone	0ms	
8	0 - No Tone	0ms	

## Operation

### To listen to the incoming ring choices:

1. Press **Speaker**.
2. Dial **711**.
3. Dial **1** to check ringing for intercom calls.  
 - OR -  
 Dial **2** to check ringing for trunk calls.
4. For Intercom calls, select the pitch you want to check (1~8).  
 - OR -  
 For trunk calls, select the pitch (1~8) and the tone (1~4) you want to check.
5. Go back to step 4 to listen to additional choices or press **Speaker** to hang up.

### To change the pitch of your incoming ring (multiline terminal only):

1. Press **Speaker**.
2. Dial **720**.
3. Dial **1** to change ringing for Intercom calls.  
 - OR -  
 Dial **2** to change ringing for trunk calls.
4. Select the pitch (1~8).
5. Press **Speaker** to hang up.

Door Box

Description

The Door Box is a self-contained Intercom unit typically used to monitor an entrance door. A visitor at the door can press the Door Box call button (like a door bell). The Door Box then sends chime tones to all extensions programmed to receive chimes. To answer the chime, the called extension user just lifts the handset. This lets the extension user talk to the visitor at the Door Box. The Door Box is convenient to have at a delivery entrance, for example. It is not necessary to have company personnel monitor the delivery entrance; they answer the Door Box chimes instead. Any number of system extensions can receive Door Box chime tones.

Each Door Box has a pair of normally open relay contacts that can connect to an electric door strike. Use these contacts to remotely control the entrance door. After answering the Door Box chimes, a multiline terminal user can press the Recall key to activate the Door Box contacts. This in turn releases the electric strike on the entrance door. The device connected to the Door Box contacts cannot exceed the contact ratings shown in the following table:

Door Box Specifications	
Contact Configuration	Normally Open
Maximum Load	60mA @30 VDC 10mA @90 VDC
Maximum Initial Contact Resistance	50m Ohms

The system can have up to eight Door Boxes. Six chime tones are available.

Conditions

- The Door Box Feature Requires a PGD(2)-U10 ADP. A maximum of 56 PGD(2)-U10 ADP units can be installed in an UNIVERGE SV9100 system. Refer to the UNIVERGE SV9100 System Hardware Manual for more information.
- If a PGD(2)-U10 ADP circuit has a Door Box (doorphone) connected, you cannot use that circuit for External Paging.
- Door Boxes can ring multiline, single line, and wireless telephones. Refer to specific device features for wireless telephone support of Door Box calls.
- A Door Box cannot ring a virtual extension.
- External Call forward by Doorphone can forward Doorphone calls Off-Premise while a user is away. This feature only works for ISDN lines.
- Off-hook signaling is available for Door Boxes. If an extension user is on the telephone, the Large LED flashes indicating the Door Box ringing, and the display shows a call from the door box.

- Each channel in the PGD(2)-U10 ADP has a jumper which must be set for Door Box operation. Refer to the UNIVERGE SV9100 System Hardware Manual for additional details.
- A Single Line Telephone (SLT), connected to an APR does not ring when the Door Phone rings the multiline telephone.
- The DTL-8R-1 and DTZ-8R-1 Cordless DECT telephones are not supported as door phone ringing members in Program 32-02.
- Cordless DECT telephones can activate the door strike relay using a Recall key assigned in the phone configuration or, by a Flash Key assigned to one of the line keys in Program 15-07 (751: 62).
- The door strike relay can be activated from the recall key on a multiline phone.
- The door strike cannot be activated when a door box is forwarded off-premise.
- Internal calls to or from a door phone are not included in the SMDR output.
- With Version 4000 or higher software, Mobile Extension can access the doorphone automatically or by manually dialing the service code.

### Default Settings

Disabled

## System Availability

### Terminals

All Terminals

### Required Component(s)

PGD(2)-U10 ADP

## Related Features

- ➔ **ISDN Compatibility**
- ➔ **Paging, External**
- ➔ **Single Line Telephones, Analog 500/2500 Sets**
- ➔ **Wireless DECT (SIP)**

## Guide to Feature Programming

The **Level 1**, **Level 2** and **Level 3** columns indicate the programs that are assigned when programming this feature in the order they are most commonly used. These levels are used with PCPro and WebPro wizards for feature programming.

- Level 1 – these are the most commonly assigned programs for this feature.
- Level 2 – these are the next most commonly assigned programs for this feature.
- Level 3 – these programs are not often assigned and require an expert level working knowledge of the system to be properly assigned.

Program Number	Program Name/Description	Input Data	Default	Level		
				1	2	3
10-03-01 (1)	<b>ETU Setup (DLCA PKG Setup) – Terminal Type (B1)</b> Set up and confirm the Basic Configuration data for terminal type (B1).	0 = Not set 1 = Multiline Terminal 3 = Bluetooth Cordless Handset 6 = PGD (Paging) 7 = PGD (Tone Ringer) 8 = PGD (Doorbox) 9 = PGD (ACI) 10 = DSS Console 11 = -- Not Used --	0		✓	
10-03-06	<b>ETU Setup (DLCA PKG Setup) – Terminal Type (B2)</b> Set up and confirm the Basic Configuration data for terminal type.  For DLC package support, set the terminal type to 8 [PGD (for Door Box)]. First set 10-03-01 to 0 with no device plugged into that port, then plug the device in and the system should recognize it as a door box and then set Program 10-03-06.	0 = Not set 6 = PGD(2)-U10 ADP (Paging) 7 = PGD(2)-U10 ADP (Tone Ringer) 8 = PGD(2)-U10 ADP (Door Box) 9 = PGD(2)-U10 ADP (ACI) 12 = APR (B2 Mode)	0	✓		
11-12-36	<b>Service Code Access (for Service Access) – Door Box Access</b> If the service code for Doorphone Access is not acceptable, change it here.	MLT, SLT 0 ~ 9, *, # Maximum of eight digits	702		✓	
15-07-01	<b>Programmable Function Keys</b> Assign a function key for External Call Forward by Doorphone (Code 54).	Line Key 1 ~ 48 0 ~ 99 (Normal Function Code 751 by default) *00 ~ *99 (Appearance Function Code) (Service Code 752 by default)	Refer to the Programming Manual for default values.		✓	
32-01-01	<b>Door Box Timers – Door Box Answer Time</b> Set the time a user has to answer the Door Box chimes.	0 ~ 64800 seconds	30		✓	

Program Number	Program Name/Description	Input Data	Default	Level		
				1	2	3
32-01-02	<b>Door Box Timers – Door Lock Cancel Time</b> Set the time the Door Box strike stays open when the single line telephone user hookflashes or a multiline terminal user presses Recall.	0 ~ 64800 seconds	10		✓	
32-01-03	<b>Door Box Timers – Off-Premise Call Forward by Door Box Disconnect Timer</b> Define the conversation time for an Off-Premise Call Forward by Door Box call. When this timer expires, the caller hears busy tone for 3 seconds (fixed time), and the call is then disconnected.	0 ~ 64800 seconds	60		✓	
32-02-01	<b>Door Box Ring Assignments</b> Determine which Door Box should ring which extension by entering the extension number. Each Door Box can be programmed to ring up to 32 extensions and an extension can be programmed to ring for multiple Door Boxes.	Maximum of eight digits	No Setting	✓		
32-03-01	<b>Door Box Basic Setup – Chime Pattern</b> Set the chime pattern (0 ~ 6) for each Door Box.	0 = None 1 = Door Box Ring 1 2 = Door Box Ring 2 3 = Door Box Ring 3 4 = Door Box Ring 4 5 = Door Box Ring 5 6 = Door Box Ring 6	Door Box 1 = 1 Door Box 2 = 2 Door Box 3 = 3 Door Box 4 = 4 Door Box 5 = 5 Door Box 6 = 6 Door Box 7 = 1 Door Box 8 = 1		✓	
32-03-02	<b>Door Box Basic Setup – CODEC Transmit Gain Setup</b> Set the Transmit Gain for each Door Box.	1 ~ 63 (-15.5dB ~ +15.5dB)	32			✓
32-03-03	<b>Door Box Basic Setup – CODEC Receive Gain Setup</b> Set the Receive Gain for each Door Box.	1 ~ 63 (-15.5dB ~ +15.5dB)	32			✓
32-04-01	<b>Door Box Name Setup – Door Box Name</b> Define the name of each Doorphone.	Maximum of 12 characters	No Setting		✓	

## Operation

### To call a Door Box:

#### Multiline Terminal

1. Press **Speaker**.
2. Dial **702**.
3. Dial Door Box Number (**1~8**).

### Single Line Telephone

1. Lift the handset.
2. Dial **702**.
3. Dial Door Box Number (**1~8**).

#### To activate the Door Box strike:

### Multiline Terminal

1. While talking to the Door Box, press **Recall**.

#### Single Line 500/2500 Telephone

1. While talking to the Door Box, hookflash.

#### To answer a Door Box chime:

1. Lift the handset or press **Speaker**.

#### To Answer a Door Box call while busy on another call:

### Multiline Terminal

*If you are busy on a call, the display shows the incoming Door Box call and the large LED flashes.*

1. Press **Hold** to place your active call on hold.
2. When you hear dial tone, dial the door box access code (**702** by default) plus the door box number (**1~8**) to answer the Door Box call.
  - ◇ *To retrieve the original call, hang up with the door box and press Conf.*

### Single Line Telephone

*If you are busy on a call, an off-hook signal is heard indicating the incoming Door Box call.*

1. Press the **Flash** key or hookflash to place your active call on hold.
2. Dial the door box access code (**702** by default) plus the door box number (**1~8**) to answer the Door Box call.
  - ◇ *To retrieve the original call, hang up. The original call rings the single line telephone.*

### To activate Call Forwarding, Off-Premise for a Door Box:



*This option only works for ISDN PRI or BRI Trunks.*

NOTE

1. At the multiline terminal, press **Speaker** + dial SC **722**.

- OR -

At the multiline terminal only, press the External Forward by Doorphone key (Program 15-07-01 or SC 751, code 54).

- OR -

At the single line telephone, lift the handset + dial **722**.

2. Dial the Door Box number (**1~4**).
3. Dial the Speed Dialing number where the calls should be forwarded.
4. Press **Speaker** (or hang up at the single line telephone) to hang up.

### To cancel Call Forwarding Off-Premise for a Door Box:

1. At the multiline terminal, press **Speaker** + dial SC **722**.

- OR -

At the multiline terminal only, press External Forward by Doorphone key (Program 15-07-01 or SC **751**, code **54**).

- OR -

At the single line telephone, lift the handset + dial **722**.

2. Dial **0** for Cancel.



## Do Not Disturb

### Description

Do Not Disturb blocks incoming calls and Paging announcements. DND permits an extension user to work by the telephone undisturbed by incoming calls and announcements. The user can activate DND while their telephone is idle or while on a call. Once activated, incoming trunk calls still flash the line keys. The user may use the telephone in the normal manner for placing and processing calls.

Five Do Not Disturb options are available at each extension. These options can be accessed via multiline terminal Softkeys, DND feature key or DND system access code.

- 1 = Incoming trunk calls blocked.
- 2 = Paging, incoming Intercom, audio doorbox chimes, Call Forwards and transferred trunk calls blocked.
- 3 = All calls blocked.
- 4 = Incoming Call Forwards blocked.
- 0 = Do Not Disturb canceled.

Multiline Line Terminals display the following to indicate the type of DND that is set.

- 1 = DND EXTERNAL
- 2 = DND INTERCOM
- 3 = DND ALL
- 4 = DND TRANSFER

### Conditions

- Do Not Disturb access code is programmable via Program 11-11-08.
- If there is no Call Forwarding key (Program 15-07: 10~17), the DND key blinks when the extension is forwarded.
- Call Arrival (CAR) Key/ Virtual Extension (VE) do not support DND Programmable Function keys.
- Multiline terminal users can activate or deactivate Do Not Disturb while on a call. This option is not available for single line telephones.
- When DND and Call Forward are set on the same telephone, call forwarding works. If Busy and No Answer Forwarding are set to different locations, it follows the Busy forwarding.
- If an extension already receiving forwarded calls activates DND option 4, callers to the forwarded extension hear DND tone.
- If an extension activates DND option 4, other extensions can still forward calls to it, but the callers hear DND tone.

- An extension user can override Call Forwarding or Do Not Disturb at another extension using any of the following methods:
  1. Program 11-12-01 Service Code Setup (for Service Access) – Bypass Call (default: 707)
  2. Program 11-16-06 Single Digit Service Code Setup – DND/Call Forward Override Bypass (default: No Setting)
  3. OVRD Softkey
- When a call is transferred because of Call Forwarding No Answer, Call Forwarding Busy, or DND, the Reason for Transfer option can display to the transferred extension while the call is ringing to the user telephone.
- DND modes 1~3 causes calls to follow Program 22-05 programming, then Program 22-08 programming even if the extension is forwarded.
- When Selectable Display Messaging is set as DND All, all other DND modes are canceled when Selectable Display Messaging is canceled.
- When DND and any Call Forwarding is set, the call forwards immediately.
- DND settings are not saved in a PC Pro database.
- If the terminal is configured for Call Forward Both Ring and DND is activated, the calling station will receive a DND tone. Call Forward Both Ring is not followed.
- When a call is ringing on an extension and Do Not Disturb (DND) is set, the DND can be enforced immediately or on the next call based on Program 20-09-13.

## Default Settings

Enabled

## System Availability

### Terminals

All Terminals

### Required Component(s)

None

## Related Features

- ➔ [Call Forwarding](#)
- ➔ [Call Forwarding/Do Not Disturb Override](#)

- ➔ [Central Office Calls, Answering](#)
- ➔ [Direct Inward Line \(DIL\)](#)
- ➔ [Distinctive Ringing, Tones and Flash Patterns](#)
- ➔ [Selectable Display Messaging](#)

## Guide to Feature Programming

The **Level 1**, **Level 2** and **Level 3** columns indicate the programs that are assigned when programming this feature in the order they are most commonly used. These levels are used with PCPro and WebPro wizards for feature programming.

- Level 1 – these are the most commonly assigned programs for this feature.
- Level 2 – these are the next most commonly assigned programs for this feature.
- Level 3 – these programs are not often assigned and require an expert level working knowledge of the system to be properly assigned.

Program Number	Program Name/Description	Input Data	Default	Level		
				1	2	3
11-11-08	<b>Service Code Setup (for Setup/Entry Operation) – Do Not Disturb</b> Assign Service Code for DND.	MLT, SLT 0 ~ 9, *, # Maximum of eight digits	747		✓	
11-12-01	<b>Service Code Setup (for Service Access) – Bypass Call</b> Assign Service Code for DND.	MLT, SLT 0 ~ 9, *, # Maximum of eight digits	707		✓	
11-16-06	<b>Single Digit Service Code Setup – DND/Call Forward Override Bypass</b> If a single digit service code is to be used, assign an available code number.	0 ~ 9, *, # Maximum of one digit	No Setting		✓	
15-07-01	<b>Programmable Function Keys</b> Assign functions to multiline terminal line keys (DND = 03).	Line Key 1 ~ 48 0 ~ 99 (Normal Function Code 751 by default) *00 ~ *99 (Appearance Function Code) (Service Code 752 by default)	Refer to the Programming Manual for default values.	✓		
20-06-01	<b>Class of Service for Extensions</b> Assign a Class of Service (1 ~ 15) to an extension.	Day Night/Mode: 1 ~ 8 Class of Service of Extensions (1 ~ 15)	Extension port 101 = Class 15 All other extension port = Class 1		✓	
20-09-13	<b>Class of Service Options (Incoming Call Service) – DND Active While Ringing</b> Assign when the DND will be enforced (set at same time a call is ringing or for next call).	0 = Immediate 1 = Next	COS 1 ~ 15 = 0		✓	

Program Number	Program Name/Description	Input Data	Default	Level		
				1	2	3
20-13-04	<b>Class of Service Options (Supplementary Service) – Call Forward/DND Override (Bypass Call)</b> Turn Off or On an extension user ability to use Call Forwarding/DND Override.	0 = Off 1 = On	COS 1 ~ 15 = 1		✓	
20-13-40	<b>Class of Service Options (Supplementary Service) – Do Not Disturb</b> Turn Off or On an extension user ability to set or cancel Do Not Disturb.	0 = Off 1 = On	COS 1 ~ 15 = 1		✓	

## Operation

To activate or deactivate Do Not Disturb while your extension is idle:

### Multiline Terminal Using Softkeys

1. Do not lift handset.
2. Press **Program** softkey.
3. Press **DND** softkey.
4. Press **Set** softkey.
5. Choose from the following softkeys:  
 Ext ICM ALL Cfwto  
 Ext=Incoming Trunk Calls Blocked  
 ICM=Incoming Intercom, Paging, call forwards and Transferred Trunk Calls Blocked.  
 ALL=All Calls Blocked  
 Cfwto=Call Forwards Blocked  
 To Cancel DND – Heading
6. Do not lift handset.
7. Press **Program** softkey.
8. Press **DND** softkey.
9. Press **Cncl** softkey.

**Multiline Terminal Using Feature Key or Access Code**

1. Do not lift the handset.
2. Press the **DND** feature key programmed in (Program15-07-01 or SC:751:03).  
**- OR -**  
Press **Speaker** and dial **747**.
3. Dial the DND option code.  
**0** = Cancel DND  
**1** = Incoming Trunk Calls Blocked  
**2** = Paging, incoming Intercom, Call Forwards and Transferred Trunk Calls Blocked  
**3** = All Calls Blocked  
**4** = Call Forwards Blocked

**Single Line Telephone**

1. Lift the handset.
2. Dial **747**.
3. Dial the DND option code.  
**0** = Cancel DND  
**1** = Incoming Trunk Calls Blocked  
**2** = Paging, Incoming Intercom, Call Forwards and Transferred Trunk Calls Blocked  
**3** = All Calls Blocked  
**4** = Call Forwards Blocked

## Drop Key

### Description

The Drop Key abandons a call while retaining the PBX/Centrex line to originate another call. The Drop Key is provided by programming a Function Key. This feature allows Recall to be used to provide a hookflash to the PBX or Central Office. A single line telephone user can use the Drop Key function with an access code.

#### Conditions

- The Drop Key provides a timed disconnect signal on CO/PBX lines.
- The Drop Key cannot be used for internal, DID, or Tie line calls.

#### Default Settings

None

### System Availability

#### Terminals

All Terminals

#### Required Component(s)

None

### Related Features

- **Flash**
- **PBX Compatibility**

## Guide to Feature Programming

The **Level 1**, **Level 2** and **Level 3** columns indicate the programs that are assigned when programming this feature in the order they are most commonly used. These levels are used with PCPro and WebPro wizards for feature programming.

- Level 1 – these are the most commonly assigned programs for this feature.
- Level 2 – these are the next most commonly assigned programs for this feature.
- Level 3 – these programs are not often assigned and require an expert level working knowledge of the system to be properly assigned.

Program Number	Program Name/Description	Input Data	Default	Level		
				1	2	3
11-12-42	<b>Service Code Setup (for Service Access) – Flash on Trunk lines</b> Customize the flash on trunk lines Service Codes.	SLT 0 ~ 9, *, # Maximum of eight digits	#3		✓	
11-12-59	<b>Service Code Setup (for Service Access) – Trunk Drop Operation for SLT</b> Customize the trunk drop operation for single line telephone Service Codes.	SLT 0 ~ 9, *, # Maximum of eight digits	No Setting	✓		
14-02-03	<b>Analog Trunk Data Setup – Flash Type</b> Select the flash type.	0 = Open Loop Flash 1 = Ground <b>Always</b> set this option for Open Loop Flash (0)	0	✓		
14-02-04	<b>Analog Trunk Data Setup – Hooking Type</b> Use Flash for Timed Flash (Program 81-01-14) or Disconnect (Program 81-01-15). (A user can press the FLASH key while on a trunk call to implement Flash.)	0 = Timed Flash (Hooking) 1 = Disconnect (Cut)	0		✓	
15-02-05	<b>Multiline Telephone Basic Data Setup – Transfer Key Operation Mode</b> If the Conf key should access Flash, enter 2. Otherwise, enter 0 or 1.	0 = Transfer 1 = Serial Call 2 = Flash	0		✓	
15-03-04	<b>Single Line Telephone Basic Data Setup – Flashing</b> Enable/Disable Flash for single line (500/2500 type) telephones.	0 = No 1 = Yes	1		✓	
15-07-01	<b>Programmable Function Keys</b> Assign a function key for Drop Key (code 84) if required.	Line Key 1 ~ 48 0 ~ 99 (Normal Function Code 751 by default) *00 ~ *99 (Appearance Function Code) (Service Code 752 by default)	Refer to the Programming Manual for default values.	✓		

Program Number	Program Name/Description	Input Data	Default	Level		
				1	2	3
20-06-01	<b>Class of Service for Extensions</b> Assign a Class of Service (1 ~ 15) to an extension.	Day Night/Mode: 1 ~ 8 Class of Service of Extensions (1 ~ 15)	Extension port 101 = Class 15 All other extension port = Class 1		✓	
81-10-07	<b>COI Initial Data Setup – Hookflash Time Selection 1</b> Set the Flash duration (20ms ~ 5.0 sec) for analog trunk [COI( )-U( ) ETU] circuits.	0 = 20ms 1 = 40ms 2 = 60ms 3 = 80ms 4 = 100ms 5 = 140ms 6 = 160ms 7 = 200ms 8 = 400ms 9 = 600ms 10 = 800ms 11 = 1.0 seconds 12 = 1.5 seconds 13 = 2.0 seconds 14 = 3.0 seconds 15 = 5.0 seconds	9 (600ms)			✓
81-10-08	<b>COI Initial Data Setup – Hookflash Time Selection 2</b> Set the open loop disconnect duration (20ms ~ 5.0 sec) for analog trunk [COI( )-U( ) ETU] circuits.	0 = 20ms 1 = 40ms 2 = 60ms 3 = 80ms 4 = 100ms 5 = 140ms 6 = 160ms 7 = 200ms 8 = 400ms 9 = 600ms 10 = 800ms 11 = 1.0 seconds 12 = 1.5 seconds 13 = 2.0 seconds 14 = 3.0 seconds 15 = 5.0 seconds	14 (3.0 seconds)			✓



## Operation

### To use the Drop Key from a multiline terminal with a CO/PBX call in progress:

1. Press the **Function** key programmed as a Drop Key.
2. Receive the new CO/PBX dial tone.
3. Dial the desired number.

### To use Feature plus Recall from a multiline terminal with a CO/PBX call in progress:

1. Press **Feature**.
2. Press **Recall**.
  - ◇ *Receive the new CO/PBX dial tone.*
3. Dial the desired number.

### To use the Drop Key feature from a single line telephone with a CO/PBX call in progress:

1. Hookflash.
2. Receive internal dial tone.
3. Dial the Service Code (Program 11-12-59, default not assigned).
4. Receive the new CO/PBX dial tone.
5. Dial the desired number.



## Description

Environmental issues, such as global warming or ecology are one of the most important themes in today's world. The following energy saving features are implemented in this system:

- ❑ **Power Cut Off Mode:**  
Based on Day/Night mode switching, the system can automatically cut power to pre-programmed multiline terminals resulting in the system consuming less power. This feature can also be activated/deactivated via service codes. When the system cuts the power to the terminal it cannot be used again until power is restored.
- ❑ **Power Saving Mode:**  
Based on a configurable system timer, preprogrammed multiline terminals can dim the brightness of all line keys and feature keys using less power. This feature does not affect the multiline terminal display.
- ❑ **Power Failure Saving Mode:**  
If the SV9100 loses system power, this feature can be programmed to cut the power to selected terminals while running on the backup battery. Cutting the power to specific terminals will help extend battery backup run time. This feature is programmed on a per station basis and is NOT enabled by default.



*When a terminal is in the Power Cut off/Power Failure mode, a user cannot dial any number including an emergency number (i.e., 911) from the station. The terminal is unusable until it returns from the power cutoff state.*

## Conditions

### Power Cut Off Mode

- While in power cut off mode, power does not automatically recover. If this is expected to occur, disable the Ecology mode before license expiration, or reboot the system to restore power to the telephones.
- The system can cut power to digital (TDM) Multiline Terminals by using power save groups. A maximum of 16 Power Save groups are supported.
- The Power Cut Off mode can be set to **On** or **Off** on a per group basis. However, Digital Station port 1 cannot be set for power cutoff. This keeps the terminal powered on for emergency calls, etc.
- If some terminals are on a call when the Power Cut Off mode is enabled, the system will wait until all extensions on the blade become idle before cutting power to the slot.

- Power Cut Off mode can be set to **On** or **Off** using one or a combination of the following methods:
  - Night mode time schedule/Manual Night Mode selection
  - Service Code
  - Function Key
- If the system is reset during the Power Cut Off mode, power to all phones is restored when the phone system comes back on line.
- When a phone has entered Power Cut Off mode, any direct calls to the terminal will follow the stations call forwarding. If the phone is part of a chain call forwarding scenario, the chain call forwarding will not process while the phone is in Power Cut Off mode.
- When a terminal is set to Power Cut Off mode, the DSS/BLF status on keys or the console will not display any status; including Hotel/Motel and Call Forward/DND.
- When a terminal is in the Power Cut Off mode, Callback requests or Camp-On cannot be set until terminal power is restored.
- Call Forward Follow Me settings are not followed when the terminal loses power from the Power Cut Off mode.
- If the terminal has Call Forward Both set and then enters the Power Cut Off mode, any calls directed to the terminal do not follow the Call Forward settings.
- Caller ID history is not updated for a terminal in a Power Cut Off mode. Once power to the terminal is restored, the Caller ID history will start functioning again.
- If the system cuts the power via the Power Cut Off mode while a user is on a call, the call is not lost. If the user places the caller on hold or park, the user's phone then switches to Power Cut Off mode and the call is lost.
- If the Power Cut Off mode is manually set to **On** during a scheduled power **Off** time, power cut remains in the **On** state until the next power cut off time, or until the Power Cut Off mode is manually set to **Off**.

### **Power Saving Mode**

- If the Multiline Terminal is idle or receives no incoming calls for the programmed period, system activates the Power Saving mode. The Line Key and feature key LED's on the Multiline Terminal will darken. This feature does not affect the terminal display.
- The Power Saving mode can be individually set for each terminal.
- Any key operation or incoming call at the terminal ends the Power Saving mode and all LEDs will return to normal brightness.

### Power Failure Saving Mode

- The same conditions as Power Cut Off mode exists with the following exceptions:
  - ❑ When the system is in the Power Failure Saving mode, power must be restored to the system before restoring power to the phones. When in a Power Failure Saving mode, a system reset will not restore power to the multiline terminals.
  - ❑ Multiline Terminals can be assigned to cut power on a per station basis when the system enters the Power Failure Saving mode. This feature does not support power save groups.

### Default Settings

None

## System Availability

### Terminals

- Multiline Terminal (DT400/DT300)

### Required Component(s)

- GCD-8DLCA/ GCD-16DLCA or GPZ-8DLCB or GCD-LTA

## Related Features

↳ [Night Service](#)

## Guide to Feature Programming

The **Level 1**, **Level 2** and **Level 3** columns indicate the programs that are assigned when programming this feature in the order they are most commonly used. These levels are used with PCPro and WebPro wizards for feature programming.

- ❑ Level 1 – these are the most commonly assigned programs for this feature.
- ❑ Level 2 – these are the next most commonly assigned programs for this feature.
- ❑ Level 3 – these programs are not often assigned and require an expert level working knowledge of the system to be properly assigned.

Program Number	Program Name/Description	Input Data	Default	Level		
				1	2	3
11-10-51	<p><b>Service Code Setup (for System Administrator) – Power Saving for Power Save Group</b></p> <p>Use to determine the Service Code setting for the Power Save feature (On/ Off) in the Power Saving Group.</p>	<p>MLT, SLT 0 ~ 9, *, # Maximum of eight digits</p>	731 (NA)	✓		
12-02-01	<p><b>Automatic Night Service Patterns – Start Time</b></p> <p>Defines the daily pattern of the automatic mode switching. Each mode group has 10 patterns. These patterns are used in Programs 12-03 and 12-04. The daily pattern consists of 20 timer settings. This option defines the start time.</p>	0000 ~ 2359	Refer to the Programming Manual for default values.		✓	
12-02-02	<p><b>Automatic Night Service Patterns – End Time</b></p> <p>Defines the daily pattern of the automatic mode switching. Each mode group has 10 patterns. These patterns are used in Programs 12-03 and 12-04. The daily pattern consists of 20 timer settings. This option defines the end time.</p>	0000 ~ 2359	Refer to the Programming Manual for default values.		✓	
12-02-03	<p><b>Automatic Night Service Patterns – Operation Mode</b></p> <p>Defines the daily pattern of the automatic mode switching. Each mode group has 10 patterns. These patterns are used in Programs 12-03 and 12-04. The daily pattern consists of 20 timer settings. This option defines the operation mode the system should be in during each time number.</p>	1 ~ 8	1 or 2 depending on the time pattern and time number.		✓	
12-03-01	<p><b>Weekly Night Service Switching</b></p> <p>Assign one of the 10 Time Patterns programmed in Program 12-02-01 to each day of the week.</p>	<p>Night Mode Service Group Numbers: 01 ~ 32 Time Schedule Pattern Number: 1 ~ 10</p>	<p>Day of Week: 01 = Sunday (Time Pattern 2) 02 = Monday (Time Pattern 1) 03 = Tuesday (Time Pattern 1) 04 = Wednesday (Time Pattern 1) 05 = Thursday (Time Pattern 1) 06 = Friday (Time Pattern 1) 07 = Saturday (Time Pattern 2)</p>			✓

Program Number	Program Name/Description	Input Data	Default	Level		
				1	2	3
12-04-01	<b>Holiday Night Service Switching</b> Assign one of the 10 Time Patterns to holidays.	Days and Months: 0101 ~ 1231 (e.g. 0101 = Jan. 1; 1231 = Dec. 31) Time Pattern Number: 0 ~ 10 (0 = No Setting)	No Setting			✓
15-02-18	<b>Multiline Telephone Basic Data Setup – Power Saving Mode</b> Enable/disable the ability of each terminal to cut power when the system is running on battery backup following a loss of power.	0 = Normal Mode 1 = Power Saving Mode (Eco-Mode)	1		✓	
15-07-01	<b>Programmable Function Keys</b> Assign a function key as a Power Saving key (code #6) 01 - 16: Power Saving Group Number 00: All Groups	Line Key 1 ~ 48 0 ~ 99 (Normal Function Code 751 by default) *00 ~ *99 (Appearance Function Code) (Service Code 752 by default)	Refer to the Programming Manual for default values.		✓	
15-27-02	<b>Power Save Setup – Power Off When Power Failure</b> Assign power cut or no power cut for each extension when the system loses power and runs on battery backup.	Maximum of eight digits 0 = Disable 1 = Enable (Power Cut)	0	✓		
20-02-10	<b>System Options for Multiline Telephones – Time Before Shifting to Power Saving Mode</b> System-wide timer that determines how long a multiline terminal is idle before shifting into the Power Saving mode.	0 = Disable 1 = 1 minute 2 = 2 minutes 3 = 4 minutes 4 = 8 minutes 5 = 16 minutes 6 = 32 minutes 7 = 64 minutes	0		✓	
20-53-01	<b>Night Mode Group Assignment for Power Save Group – Night Mode Service Group Number</b> Assigns the Night Mode Service group number into the Power Save group.	Power Save Group Number 1 ~ 16 Night Mode Service group number 1 ~ 32	1		✓	
20-54-01	<b>Power Supply Mode for Each Power Save Group – Power Saving Mode</b> Assign the Power Saving mode in each Power Saving group and Night mode.	Power Save Group Number 1 ~ 16 Night Mode 1 ~ 8 0 = Power Cut 1 = Power Supply	1	✓		
90-02-02	<b>Programming Password Setup – Password</b> Configure the administrator accounts that are used when Power cut to the Power Save group.	Maximum of eight digits.	Refer to the Programming Manual for default values.	✓		

## Operation

### Power Cut Off Mode

**To cut the power for Power Save Group 2 during the night time (19:00-6:00):**

< Program >

Program 20-53-01: Power Save Group 2 Set 1 for Night mode Service Group Number

Program 20-53-01: Power Save Group 3 Set 1 for Night mode Service Group Number

Program 20-54-01: Power Save Group 2

Night Mode 1: Power Saving Mode 1 (Power Supply)

Night Mode 2: Power Saving Mode 0 (Power cut)

Program 20-54-01: Power Save Group 3

Night Mode 1: Power Save Mode 1 (Power Supply)

Night Mode 2: Power Save Mode 1 (Power cut)

Program 15-27-01:

TEL 101: Power Save Group 2

TEL 102: Power Save Group 2

TEL 103: Power Save Group 3

TEL 104: Power Save Group 3

*Table 2-22 Program 12-02: Automatic Night Service Patterns*

Night Group Mode	Time Pattern	Set Time Number	Start	End	Night Mode
1	1	1	0000	0600	2
1	1	2	0600	1900	1
1	1	3	1900	0000	2



The power to TEL 101 and TEL 102 cuts at night.

Figure 2-20 Automatic Night Service

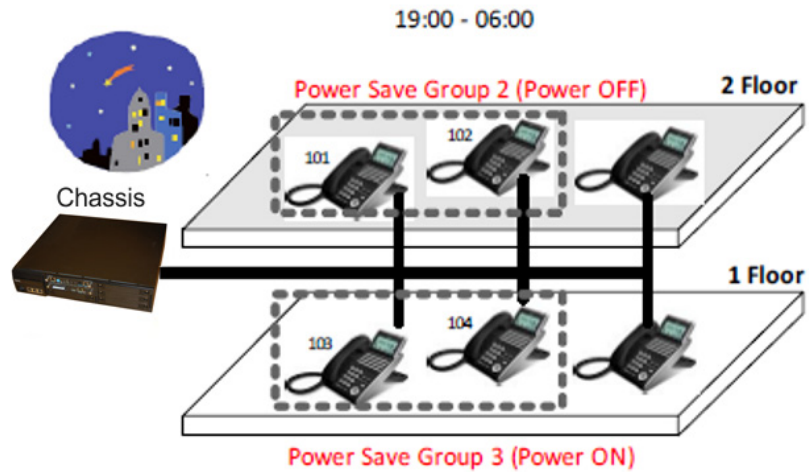

### Settings Using Service Codes

< Program >

Program 15-27-01:

TEL 101: Power Save Group 2

TEL 102: Power Save Group 2

#### Power Off for Power Save Group 2

1. Press **Speaker** and dial (Service Code 731).
2. Dial **02**, Group 2
3. Dial **1**, Power Off
4. Enter the Password (Default: 0000)
  - ◇ Power supply to the system is cut when all terminals of Power Save group 2 are in an Idle state.
  - ◇ Password is set in Program 90-02-02 (User ID3).
5. Press Speaker to set Power Off for Power Save Group 2.

#### Power On for Power Save Group 2

1. Press **Speaker** and dial (Service Code 731).
2. Dial **02**, Group 2
3. Dial **0**, Power On
4. Press Speaker to set Power On for Power Save Group 2.

#### Power Off for the Entire Power Save Group

1. Press **Speaker** and dial (Service Code 731).

2. Dial **00**, Entire Group
3. Dial **1**, Power Off
4. Enter the Password (Default: 0000)
  - ◇ Power supply to the system is cut when all terminals of Entire Power Save Group are in an Idle state.
  - ◇ Password is set in Program 90-02-02 (User ID3).
5. Press Speaker to set Power Off for Entire Power Save Group.

#### Power On for the Entire Power Save Group

1. Press **Speaker** and dial (Service Code 731).
2. Dial **00**, Entire Group
3. Dial **0**, Power On
4. Press Speaker to set Power On for Entire Power Save Group.

### Settings Using Function Keys

#### Power Off for Power Save Group 2

1. Assign Power Save key (SC751 code #06) with additional data 02.
2. Press the Power Save key.
3. Enter the Password (set in Program 90-02-02 User ID3).
4. The key turns red.

#### Power On for Power Save Group 2

1. Assign Power Save key (SC751 code #06) with additional data 02.
2. Press the Power Save key.
3. The key is turned **Off**.

#### Power Off for the Entire Power Save Group

1. Assign Power Save key (SC751 code #06) with additional data 00.
2. Press the Power Save key.
3. Enter the Password (set in Program 90-02-02 User ID3).
4. The key turns red.

#### Power On for the Entire Power Save Group

1. Assign Power Save key (SC751 code #06) with additional data 00.
2. Press the Power Save key.
3. The key is turned **Off**.

**Power Saving Mode**

< Program >

Program 15-02-18: TEL 200: 1

Program 20-02-10: 1 minute

1. Idle state at TEL200.
2. One minute later, LED areas highlighted in red darken at TEL200.

Figure 2-21 Multiline Terminal Darkens

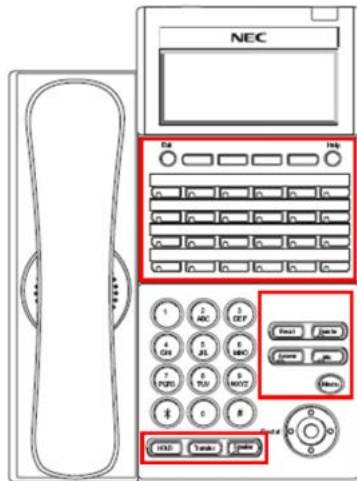

**Power Failure Saving Mode**

Set Program 15-27-02 to **1** for extensions to have the power cut when the system losses power and runs on battery backup.

Example

< Program >

Program 15-27-02:

TEL 101: set to a 1

TEL 102: set to a 1

TEL 103: set to a 0

TEL 104: set to a 0

TEL 101 TEL 102 will be powered **Off** when a power failure occurs.

## E-911 Compatibility

### Description



IMPORTANT

#### **PLEASE NOTE THE FOLLOWING!**

- *When ARS is NOT enabled and the system allows trunk access by dialing 9, single line telephones disregard Program 20-03-03 – System Options for Single Lines Telephones – SLT DTMF Dial to Trunk Lines. This prevents the system from connecting to a trunk until all the digits are dialed. This can be avoided by using either 8 or 9x (but not 91) as the trunk access code. Be aware that this change requires additional programming changes.*
- *Do not use \* in a PBX access code if the Account Code feature is used. With the Account Code feature enabled, if this is used in the access code, the trunk stops sending digits to the central office after the \* is sent.*
- *Finally, but most importantly, TEST - TEST - TEST!! Due to the nature of the E911 feature, it is imperative that when programming this, or any other feature, to be aware of the consequences. Make sure to test the extensions with the E911 feature to confirm that other features do not prevent the call from being completed. When using external equipment, make sure the dial treatment tables are working properly.*

E-911 Compatibility ensures that emergency calls always get through. If an emergency occurs, a user goes to any telephone, lifts the handset and dials 911. The system built-in E-911 Compatibility places the emergency call even if the user forgets to dial an access code or press a line key. The E911 abilities include:

#### Attendant Notification

The attendant receives a notification each time a co-worker dials an emergency 911 call. This notification is the co-worker's name and number display optionally accompanied by an audible alarm. Notification occurs regardless of whether the attendant is idle or busy on a call. You can optionally extend this ability to other supervisory extensions as well.



NOTE

*The 911 display alarm is not canceled when going off-hook and dialing access code 786. The EXIT key must be used to cancel the display alarm.*

#### Emergency Routing

When an extension user dials 911, the system can automatically find a trunk for the call. The system can choose a route to which the user normally does not have access. If all normal routes are busy, the system can even disconnect an active call and place the emergency call. E-911 Compatibility uses the flexibility of the Automatic Route Selection (ARS) Call Route Options to route 911 emergency calls (even in systems in which ARS is not enabled).

##### ○ E911 Outgoing Dialing

The E911 call follows the trunk group route programming. It is possible to use the flexibility of the Automatic Route Selection (ARS) Call Route Options for additional routing options.

##### ○ Forced Disconnect Follows Timer to Disconnect Call

When all lines in the programmed route are busy and the system must drop a call to place a 911 call, the system waits the time set in Program 81-01 before disconnecting the call.

Calling Party Identification

With ISDN installed, the system can provide the Calling Party Number (CPN) Presentation from Station. No additional customer-provided 911 equipment is required.

**Uninstalled Trunks in Trunk Group Prevent Call from Dialing Out**

By system default, all trunks in Program 14-05-01 Trunk Group are in group 1. When placing a 911 call, the system tries to access the trunks defined in the group. If the trunks do not exist, the call does not dial out. For E911 to function correctly, remove any uninstalled trunks from the trunk group.

If Program 21-01-12 : System Options for Outgoing Calls, Dial 911 Routing Without Trunk Access is set to 0 (trunk access code required), when using the Dial Number Preview feature and dialing 9+911, if all trunks are busy, the user hears a busy signal and the call does not dial out.

If option Program 21-01-12 is set to 1 (trunk access code not required) and using Dial Number Preview, 911 is dialed, the system disconnects a trunk and dials the call.

Dial Number Preview is when a telephone number is first dialed (previewing the number in the display) then Speaker or a line key is pressed to place the call.

**Conditions**

- If Program 21-01-10 is programmed with an entry other than 0, a call does not have a talk path unless the user dials at least the number of digits entered in this option when placing an outgoing call. This means that an entry of 4 or higher in this program causes a problem when dialing 911. Since it is only a 3-digit number, the call does not have a talk path, preventing the emergency dispatcher from hearing the caller. This option should be kept at its default setting of 0 to prevent any problem with dialing 911.
- CAMA Trunks are not supported.
- The 911 Cut Through feature works when dialing trunk Access+911.

**Calling Party Number (CPN)**

CPN sent when making a normal trunk call from a terminal.

*Table 2-23 CPN for Standard Calls*

PRG 99-01-58	PRG 20-08-13	PRG 21-12-01	PRG 21-13-01	CPN: PRG
Off	Off	Not Assigned	Not Assigned	None *
			Assigned	None *
		Assigned	Not Assigned	21-12-01
			Assigned	21-12-01
	On	Not Assigned	Not Assigned	None *
			Assigned	21-13-01
		Assigned	Not Assigned	21-12-01
			Assigned	21-13-01

Table 2-23 CPN for Standard Calls (Continued)

PRG 99-01-58	PRG 20-08-13	PRG 21-12-01	PRG 21-13-01	CPN: PRG
On	Off	Not Assigned	Not Assigned	None *
			Assigned	None *
		Assigned	Not Assigned	21-12-01
			Assigned	21-12-01
	On	Not Assigned	Not Assigned	None *
			Assigned	21-13-01
		Assigned	Not Assigned	21-12-01
			Assigned	21-13-01

\* The CPN provided is from the service provider.

CPN sent when making a normal trunk call from a Virtual Extension (VE).

Table 2-24 CPN for VE Standard Calls

PRG 99-01-58	PRG 20-08-13	PRG 21-12-01	PRG 21-13-01		CPN: PRG	
			Terminal	VE		
Off	Off	Not Assigned	Not Assigned	Not Assigned	None *	
			Not Assigned	Assigned	None *	
			Assigned	Not Assigned	None *	
			Assigned	Assigned	None *	
		Assigned	Not Assigned	Not Assigned	21-12-01	
			Not Assigned	Assigned	21-12-01	
			Assigned	Not Assigned	21-12-01	
			Assigned	Assigned	21-12-01	
	On	Not Assigned	Not Assigned	Not Assigned	None *	
			Not Assigned	Assigned	21-13-01 (VE)	
			Assigned	Not Assigned	None *	
			Assigned	Assigned	21-13-01 (VE)	
		Assigned	Not Assigned	Not Assigned	21-12-01	
			Not Assigned	Assigned	21-13-01 (VE)	
			Assigned	Not Assigned	21-12-01	
			Assigned	Assigned	21-13-01 (VE)	
	On	Off	Not Assigned	Not Assigned	Not Assigned	None *
				Not Assigned	Assigned	21-13-01 (VE)
				Assigned	Not Assigned	None *
				Assigned	Assigned	21-13-01 (VE)
Assigned			Not Assigned	Not Assigned	21-12-01	
			Not Assigned	Assigned	21-13-01 (VE)	
			Assigned	Not Assigned	21-12-01	
			Assigned	Assigned	21-13-01 (VE)	
On		Not Assigned	Not Assigned	Not Assigned	None *	
			Not Assigned	Assigned	21-13-01 (VE)	
			Assigned	Not Assigned	None *	
			Assigned	Assigned	21-13-01 (VE)	

Table 2-24 CPN for VE Standard Calls (Continued)

PRG 99-01-58	PRG 20-08-13	PRG 21-12-01	PRG 21-13-01		CPN: PRG
			Terminal	VE	
On	On	Assigned	Not Assigned	Not Assigned	21-12-01
			Not Assigned	Assigned	21-13-01 (VE)
			Assigned	Not Assigned	21-12-01
			Assigned	Assigned	21-13-01 (VE)

\* The CPN provided is from the service provider.

CPN sent when making a 911 call from a terminal.

Table 2-25 CPN for 911 Calls

PRG 99-01-58	PRG 20-08-13	PRG 21-12-01	PRG 21-13-01	CPN: PRG
Off	Off	Not Assigned	Not Assigned	None *
			Assigned	None *
		Assigned	Not Assigned	21-12-01
			Assigned	21-12-01
	On	Not Assigned	Not Assigned	None *
			Assigned	21-13-01
Assigned	Not Assigned	Not Assigned	21-12-01	
		Assigned	21-13-01	
On	Off	Not Assigned	Not Assigned	None *
			Assigned	21-13-01
		Assigned	Not Assigned	21-12-01
			Assigned	21-13-01
	On	Not Assigned	Not Assigned	None *
			Assigned	21-13-01
Assigned	Not Assigned	Not Assigned	21-12-01	
		Assigned	21-13-01	

\* The CPN provided is from the service provider.

CPN sent when making a 911 call from a Virtual Extension (VE).

Table 2-26 CPN for VE 911 Calls

PRG 99-01-58	PRG 20-08-13	PRG 21-12-01	PRG 21-13-01		CPN: PRG
			Terminal	VE	
Off	Off	Not Assigned	Not Assigned	Not Assigned	None *
			Not Assigned	Assigned	None *
			Assigned	Not Assigned	None *
			Assigned	Assigned	None *
		Assigned	Not Assigned	Not Assigned	21-12-01
			Not Assigned	Assigned	21-12-01
			Assigned	Not Assigned	21-12-01
			Assigned	Assigned	21-12-01
	On	Not Assigned	Not Assigned	Not Assigned	None *
			Not Assigned	Assigned	21-13-01 (VE)
			Assigned	Not Assigned	None *
			Assigned	Assigned	21-13-01 (VE)
		Assigned	Not Assigned	Not Assigned	21-12-01
			Not Assigned	Assigned	21-13-01 (VE)
			Assigned	Not Assigned	21-12-01
			Assigned	Assigned	21-13-01 (VE)
On	Off	Not Assigned	Not Assigned	Not Assigned	None *
			Not Assigned	Assigned	21-13-01 (VE)
			Assigned	Not Assigned	21-13-01 (Terminal)
			Assigned	Assigned	21-13-01 (Terminal)
		Assigned	Not Assigned	Not Assigned	21-12-01
			Not Assigned	Assigned	21-13-01 (VE)
			Assigned	Not Assigned	21-13-01 (Terminal)
			Assigned	Assigned	21-13-01 (Terminal)
	On	Not Assigned	Not Assigned	Not Assigned	None *
			Not Assigned	Assigned	21-13-01 (VE)
			Assigned	Not Assigned	21-13-01 (Terminal)
			Assigned	Assigned	21-13-01 (Terminal)
		Assigned	Not Assigned	Not Assigned	21-12-01
			Not Assigned	Assigned	21-13-01 (VE)
			Assigned	Not Assigned	21-13-01 (Terminal)
			Assigned	Assigned	21-13-01 (Terminal)

\* The CPN provided is from the service provider.



Figure 2-22 CCIS Standard Calls

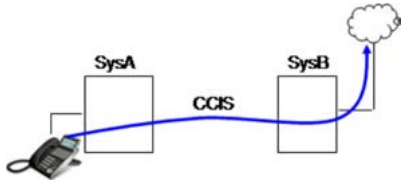

CPN sent when making a normal trunk call across CCIS trunks from a terminal.

Table 2-27 CPN for CCIS Standard Calls

System A				System B			CPN: PRG		
PRG 99-01-58	PRG 20-08-13	PRG 21-12-01	PRG 21-13-01	PRG 20-08-13	PRG 21-12-01	PRG 14-01-24			
Off	Off	Not Assigned	Not Assigned	Off	Not Assigned	Off	None *		
						On	None *		
					Assigned	Off	21-12-01 (SysB)		
				On	21-12-01 (SysB)				
				On	Not Assigned	Off	None *		
						On	None *		
			Assigned		Off	21-12-01 (SysB)			
			On	21-12-01 (SysB)					
			Assigned	Off	Not Assigned	Off	Off	None *	
							On	None *	
					Assigned	Off	21-12-01 (SysB)		
				On	21-12-01 (SysB)				
		On		Not Assigned	Off	Off	None *		
						On	None *		
			Assigned	Off	21-12-01 (SysB)				
		On	21-12-01 (SysB)						
		Assigned	Not Assigned	Off	Not Assigned	Off	Off	21-12-01 (SysA)	
							On	21-12-01 (SysA)	
					Assigned	Off	21-12-01 (SysA)		
				On	21-12-01 (SysA)				
				On	Not Assigned	Off	Not Assigned	Off	21-12-01 (SysA)
								On	21-12-01 (SysA)
			Assigned		Off	21-12-01 (SysA)			
			On	21-12-01 (SysA)					
Assigned	Off		Not Assigned	Off	Off	21-12-01 (SysA)			
					On	21-12-01 (SysA)			
			Assigned	Off	21-12-01 (SysA)				
	On		21-12-01 (SysA)						
	On	Not Assigned	Off	Not Assigned	Off	21-12-01 (SysA)			
					On	21-12-01 (SysA)			
Assigned		Off	21-12-01 (SysA)						
On	21-12-01 (SysA)								

Table 2-27 CPN for CCIS Standard Calls (Continued)

System A				System B			CPN: PRG
PRG 99-01-58	PRG 20-08-13	PRG 21-12-01	PRG 21-13-01	PRG 20-08-13	PRG 21-12-01	PRG 14-01-24	
Off	On	Not Assigned	Not Assigned	Off	Not Assigned	Off	None *
					Assigned	On	None *
				On	Not Assigned	Off	21-12-01 (SysB)
					Assigned	On	21-12-01 (SysB)
				Off	Not Assigned	Off	None *
					Assigned	On	None *
		Assigned	Off	Assigned	Not Assigned	Off	21-12-01 (SysB)
					Assigned	On	21-12-01 (SysB)
			On	Assigned	Not Assigned	Off	21-12-01 (SysB)
					Assigned	On	21-12-01 (SysB)
			Off	Assigned	Not Assigned	Off	21-13-01 (SysA)
					Assigned	On	21-13-01 (SysA)
	Assigned	Off	Assigned	Not Assigned	Off	21-13-01 (SysA)	
				Assigned	On	21-13-01 (SysA)	
		On	Assigned	Not Assigned	Off	21-13-01 (SysA)	
				Assigned	On	21-13-01 (SysA)	
		Off	Assigned	Not Assigned	Off	21-13-01 (SysA)	
				Assigned	On	21-13-01 (SysA)	
	On	Not Assigned	Off	Not Assigned	Not Assigned	Off	21-12-01 (SysA)
					Assigned	On	21-12-01 (SysA)
			On	Not Assigned	Not Assigned	Off	21-12-01 (SysA)
					Assigned	On	21-12-01 (SysA)
			Off	Assigned	Not Assigned	Off	21-12-01 (SysA)
					Assigned	On	21-12-01 (SysA)
Assigned		Off	Assigned	Not Assigned	Off	21-12-01 (SysA)	
				Assigned	On	21-12-01 (SysA)	
		On	Assigned	Not Assigned	Off	21-12-01 (SysA)	
				Assigned	On	21-12-01 (SysA)	
		Off	Assigned	Not Assigned	Off	21-13-01 (SysA)	
				Assigned	On	21-13-01 (SysA)	
On	Assigned	Not Assigned	Off	21-13-01 (SysA)			
		Assigned	On	21-13-01 (SysA)			

Table 2-27 CPN for CCIS Standard Calls (Continued)

System A				System B			CPN: PRG
PRG 99-01-58	PRG 20-08-13	PRG 21-12-01	PRG 21-13-01	PRG 20-08-13	PRG 21-12-01	PRG 14-01-24	
On	Off	Not Assigned	Not Assigned	Off	Not Assigned	Off	None *
					On	On	None *
				Assigned	Off	21-12-01 (SysB)	
			On	Not Assigned	Off	21-12-01 (SysB)	
					On	None *	
				Assigned	Off	21-12-01 (SysB)	
		Assigned	Off	Not Assigned	Off	21-12-01 (SysB)	
					On	21-12-01 (SysB)	
				Assigned	Off	None *	
			On	Not Assigned	Off	None *	
					On	None *	
				Assigned	Off	21-12-01 (SysB)	
	Assigned	Not Assigned	Not Assigned	Off	Not Assigned	Off	21-12-01 (SysA)
					On	On	21-12-01 (SysA)
				Assigned	Off	21-12-01 (SysA)	
			On	Not Assigned	Off	21-12-01 (SysA)	
					On	21-12-01 (SysA)	
				Assigned	Off	21-12-01 (SysA)	
		Assigned	Off	Not Assigned	Off	21-12-01 (SysA)	
					On	21-12-01 (SysA)	
				Assigned	Off	21-12-01 (SysA)	
			On	Not Assigned	Off	21-12-01 (SysA)	
					On	21-12-01 (SysA)	
				Assigned	Off	21-12-01 (SysA)	

Table 2-27 CPN for CCIS Standard Calls (Continued)

System A				System B			CPN: PRG				
PRG 99-01-58	PRG 20-08-13	PRG 21-12-01	PRG 21-13-01	PRG 20-08-13	PRG 21-12-01	PRG 14-01-24					
On	On	Not Assigned	Not Assigned	Off	Not Assigned	Off	None *				
					Not Assigned	On	None *				
					Assigned	Off	21-12-01 (SysB)				
				Assigned	On	21-12-01 (SysB)					
				On	Not Assigned	Off	None *				
					Not Assigned	On	None *				
			Assigned		Off	21-12-01 (SysB)					
			Assigned	Off	Assigned	Off	Not Assigned	Off	21-13-01 (SysA)		
							Not Assigned	On	21-13-01 (SysA)		
							Assigned	Off	21-13-01 (SysA)		
				On	Assigned	Assigned	On	Not Assigned	Off	21-13-01 (SysA)	
								Not Assigned	On	21-13-01 (SysA)	
		Assigned						Off	21-13-01 (SysA)		
		Assigned	Not Assigned	Not Assigned	Off	Not Assigned	Off	21-12-01 (SysA)			
						Not Assigned	On	21-12-01 (SysA)			
						Assigned	Off	21-12-01 (SysA)			
					On	Not Assigned	Not Assigned	On	Not Assigned	Off	21-12-01 (SysA)
									Not Assigned	On	21-12-01 (SysA)
									Assigned	Off	21-12-01 (SysA)
			Assigned	Off	Assigned	Assigned	Off	Not Assigned	Off	21-13-01 (SysA)	
								Not Assigned	On	21-13-01 (SysA)	
								Assigned	Off	21-13-01 (SysA)	
				On	Assigned	Assigned	On	Not Assigned	Off	21-13-01 (SysA)	
								Not Assigned	On	21-13-01 (SysA)	
Assigned	Off							21-13-01 (SysA)			
						On	21-13-01 (SysA)				

\* The CPN provided is from the service provider.

Figure 2-23 CCIS VE Standard Calls

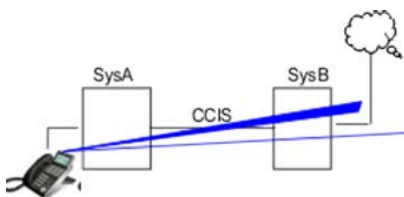

CPN sent when making a normal trunk call across CCIS trunks from a Virtual Extension (VE).

Table 2-28 CPN for CCIS VE Standard Calls

System A					System B			CPN: PRG
PRG 99-01-58	PRG 20-08-13	PRG 21-12-01	PRG 21-13-01		PRG 20-08-13	PRG 21-12-01	PRG 14-01-24	
			Terminal	VE				
Off	Off	Not Assigned	Not Assigned	Not Assigned	Off	Not Assigned	Off	None *
						Assigned	On	None *
						Assigned	Off	21-12-01 (SysB)
					Assigned	On	21-12-01 (SysB)	
					On	Not Assigned	Off	None *
					Assigned	On	None *	
			Assigned	Off	Not Assigned	Off	None *	
					Assigned	On	None *	
					Assigned	Off	21-12-01 (SysB)	
				On	Not Assigned	On	None *	
					Assigned	Off	21-12-01 (SysB)	
					Assigned	On	21-12-01 (SysB)	
		Assigned	Not Assigned	Off	Not Assigned	Off	None *	
					Assigned	On	None *	
					Assigned	Off	21-12-01 (SysB)	
				On	Not Assigned	On	None *	
					Assigned	Off	21-12-01 (SysB)	
					Assigned	On	21-12-01 (SysB)	
			Assigned	Off	Not Assigned	Off	None *	
					Assigned	On	None *	
					Assigned	Off	21-12-01 (SysB)	
				On	Not Assigned	On	None *	
					Assigned	Off	21-12-01 (SysB)	
					Assigned	On	21-12-01 (SysB)	

Table 2-28 CPN for CCIS VE Standard Calls (Continued)

System A					System B			CPN: PRG
PRG 99-01-58	PRG 20-08-13	PRG 21-12-01	PRG 21-13-01		PRG 20-08-13	PRG 21-12-01	PRG 14-01-24	
			Terminal	VE				
Off	Off	Assigned	Not Assigned	Not Assigned	Off	Not Assigned	Off	21-12-01 (SysA)
						Assigned	On	21-12-01 (SysA)
						Assigned	Off	21-12-01 (SysA)
					Assigned	On	21-12-01 (SysA)	
					Assigned	Off	21-12-01 (SysA)	
					Assigned	On	21-12-01 (SysA)	
			Assigned	Off	Not Assigned	Off	21-12-01 (SysA)	
					Assigned	On	21-12-01 (SysA)	
					Assigned	Off	21-12-01 (SysA)	
				Assigned	On	Not Assigned	On	21-12-01 (SysA)
						Assigned	Off	21-12-01 (SysA)
						Assigned	On	21-12-01 (SysA)
		Assigned	Not Assigned	Off	Not Assigned	Off	21-12-01 (SysA)	
					Assigned	On	21-12-01 (SysA)	
					Assigned	Off	21-12-01 (SysA)	
				Assigned	On	Not Assigned	On	21-12-01 (SysA)
						Assigned	Off	21-12-01 (SysA)
						Assigned	On	21-12-01 (SysA)
			Assigned	Off	Not Assigned	Off	21-12-01 (SysA)	
					Assigned	On	21-12-01 (SysA)	
					Assigned	Off	21-12-01 (SysA)	
				Assigned	On	Not Assigned	On	21-12-01 (SysA)
						Assigned	Off	21-12-01 (SysA)
						Assigned	On	21-12-01 (SysA)

Table 2-28 CPN for CCIS VE Standard Calls (Continued)

System A					System B			CPN: PRG		
PRG 99-01-58	PRG 20-08-13	PRG 21-12-01	PRG 21-13-01		PRG 20-08-13	PRG 21-12-01	PRG 14-01-24			
			Terminal	VE						
Off	On	Not Assigned	Not Assigned	Not Assigned	Off	Not Assigned	Off	None *		
						Assigned	On	None *		
					On	Not Assigned	Off	21-12-01 (SysB)		
						Assigned	On	21-12-01 (SysB)		
					Assigned	Not Assigned	Off	None *		
						Assigned	On	None *		
			Assigned	Off	Not Assigned	Off	21-12-01 (SysB)			
					Assigned	On	21-12-01 (SysB)			
				On	Not Assigned	Off	21-12-01 (SysB)			
					Assigned	On	21-12-01 (SysB)			
				Assigned	Not Assigned	Off	21-13-01(SysA:VE)			
					Assigned	On	21-13-01(SysA:VE)			
		Assigned	Not Assigned	Off	Not Assigned	Off	Not Assigned	Off	21-13-01(SysA:VE)	
							Assigned	On	21-13-01(SysA:VE)	
				On	Not Assigned	Off	21-13-01(SysA:VE)			
					Assigned	On	21-13-01(SysA:VE)			
				Assigned	Not Assigned	Off	21-13-01(SysA:VE)			
					Assigned	On	21-13-01(SysA:VE)			
			Assigned	Off	Not Assigned	Not Assigned	Off	Not Assigned	Off	None *
								Assigned	On	None *
				On	Not Assigned	Off	21-12-01 (SysB)			
					Assigned	On	21-12-01 (SysB)			
				Assigned	Not Assigned	Off	21-12-01 (SysB)			
					Assigned	On	21-12-01 (SysB)			
Assigned	Off	Not Assigned	Not Assigned	Off	Not Assigned	Off	21-13-01(SysA:VE)			
					Assigned	On	21-13-01(SysA:VE)			
Assigned	On	Not Assigned	Not Assigned	Off	Not Assigned	Off	21-13-01(SysA:VE)			
					Assigned	On	21-13-01(SysA:VE)			
Assigned	On	Not Assigned	Not Assigned	On	Not Assigned	Off	21-13-01(SysA:VE)			
					Assigned	On	21-13-01(SysA:VE)			

Table 2-28 CPN for CCIS VE Standard Calls (Continued)

System A					System B			CPN: PRG
PRG 99-01-58	PRG 20-08-13	PRG 21-12-01	PRG 21-13-01		PRG 20-08-13	PRG 21-12-01	PRG 14-01-24	
			Terminal	VE				
Off	On	Assigned	Not Assigned	Not Assigned	Off	Not Assigned	Off	21-12-01 (SysA)
						Assigned	On	21-12-01 (SysA)
						Not Assigned	Off	21-12-01 (SysA)
					Assigned	On	21-12-01 (SysA)	
					Not Assigned	Off	21-12-01 (SysA)	
					Assigned	On	21-12-01 (SysA)	
			Assigned	Off	Not Assigned	Off	21-13-01(SysA:VE)	
					Assigned	On	21-13-01(SysA:VE)	
					Not Assigned	Off	21-13-01(SysA:VE)	
				On	Not Assigned	On	21-13-01(SysA:VE)	
					Assigned	Off	21-13-01(SysA:VE)	
					Assigned	On	21-13-01(SysA:VE)	
		Assigned	Not Assigned	Off	Not Assigned	Off	21-12-01 (SysA)	
					Assigned	On	21-12-01 (SysA)	
					Not Assigned	Off	21-12-01 (SysA)	
				On	Not Assigned	On	21-12-01 (SysA)	
					Assigned	Off	21-12-01 (SysA)	
					Assigned	On	21-12-01 (SysA)	
			Assigned	Off	Not Assigned	Off	21-13-01(SysA:VE)	
					Assigned	On	21-13-01(SysA:VE)	
					Not Assigned	Off	21-13-01(SysA:VE)	
				On	Not Assigned	On	21-13-01(SysA:VE)	
					Assigned	Off	21-13-01(SysA:VE)	
					Assigned	On	21-13-01(SysA:VE)	



Table 2-28 CPN for CCIS VE Standard Calls (Continued)

System A					System B			CPN: PRG
PRG 99-01-58	PRG 20-08-13	PRG 21-12-01	PRG 21-13-01		PRG 20-08-13	PRG 21-12-01	PRG 14-01-24	
			Terminal	VE				
On	Off	Not Assigned	Not Assigned	Not Assigned	Off	Not Assigned	Off	None *
						Assigned	On	None *
					On	Not Assigned	Off	21-12-01 (SysB)
						Assigned	On	21-12-01 (SysB)
					Off	Not Assigned	Off	None *
						Assigned	On	None *
			Assigned	Off	Not Assigned	Off	21-12-01 (SysB)	
					Assigned	On	21-12-01 (SysB)	
				On	Not Assigned	Off	21-12-01 (SysB)	
					Assigned	On	21-12-01 (SysB)	
				Off	Not Assigned	Off	21-13-01(SysA:VE)	
					Assigned	On	21-13-01(SysA:VE)	
		Assigned	On	Not Assigned	Off	21-13-01(SysA:VE)		
				Assigned	On	21-13-01(SysA:VE)		
			Off	Not Assigned	Off	21-13-01(SysA:VE)		
				Assigned	On	21-13-01(SysA:VE)		
			On	Not Assigned	Off	21-13-01(SysA:VE)		
				Assigned	On	21-13-01(SysA:VE)		
		Assigned	Off	Not Assigned	Off	21-13-01(SysA:VE)		
				Assigned	On	21-13-01(SysA:VE)		
			On	Not Assigned	Off	21-13-01(SysA:VE)		
				Assigned	On	21-13-01(SysA:VE)		
			Off	Not Assigned	Off	21-13-01(SysA:VE)		
				Assigned	On	21-13-01(SysA:VE)		
Assigned	On	Not Assigned	Off	21-13-01(SysA:VE)				
		Assigned	On	21-13-01(SysA:VE)				
	Off	Not Assigned	Off	21-13-01(SysA:VE)				
		Assigned	On	21-13-01(SysA:VE)				
	On	Not Assigned	Off	21-13-01(SysA:VE)				
		Assigned	On	21-13-01(SysA:VE)				

Table 2-28 CPN for CCIS VE Standard Calls (Continued)

System A					System B			CPN: PRG
PRG 99-01-58	PRG 20-08-13	PRG 21-12-01	PRG 21-13-01		PRG 20-08-13	PRG 21-12-01	PRG 14-01-24	
			Terminal	VE				
On	Off	Assigned	Not Assigned	Not Assigned	Off	Not Assigned	Off	21-12-01 (SysA)
						Assigned	On	21-12-01 (SysA)
						Assigned	Off	21-12-01 (SysA)
					Assigned	On	21-12-01 (SysA)	
					Assigned	Off	21-12-01 (SysA)	
					Assigned	On	21-12-01 (SysA)	
			Assigned	Off	Not Assigned	Off	21-13-01(SysA:VE)	
					Assigned	On	21-13-01(SysA:VE)	
					Assigned	Off	21-13-01(SysA:VE)	
				On	Not Assigned	On	21-13-01(SysA:VE)	
					Assigned	Off	21-13-01(SysA:VE)	
					Assigned	On	21-13-01(SysA:VE)	
		Assigned	Not Assigned	Off	Not Assigned	Off	21-12-01 (SysA)	
					Assigned	On	21-12-01 (SysA)	
					Assigned	Off	21-12-01 (SysA)	
				On	Not Assigned	On	21-12-01 (SysA)	
					Assigned	Off	21-12-01 (SysA)	
					Assigned	On	21-12-01 (SysA)	
			Assigned	Off	Not Assigned	Off	21-13-01(SysA:VE)	
					Assigned	On	21-13-01(SysA:VE)	
					Assigned	Off	21-13-01(SysA:VE)	
				On	Not Assigned	On	21-13-01(SysA:VE)	
					Assigned	Off	21-13-01(SysA:VE)	
					Assigned	On	21-13-01(SysA:VE)	

Table 2-28 CPN for CCIS VE Standard Calls (Continued)

System A					System B			CPN: PRG	
PRG 99-01-58	PRG 20-08-13	PRG 21-12-01	PRG 21-13-01		PRG 20-08-13	PRG 21-12-01	PRG 14-01-24		
			Terminal	VE					
On	On	Not Assigned	Not Assigned	Not Assigned	Off	Not Assigned	Off	None *	
						Assigned	On	None *	
						Assigned	Off	21-12-01 (SysB)	
					Assigned	On	21-12-01 (SysB)		
					Not Assigned	Off	None *		
					Not Assigned	On	None *		
				Assigned	Off	Not Assigned	Off	21-12-01 (SysB)	
						Assigned	On	21-12-01 (SysB)	
						Assigned	Off	21-13-01(SysA:VE)	
					On	Off	Not Assigned	On	21-13-01(SysA:VE)
							Assigned	Off	21-13-01(SysA:VE)
							Assigned	On	21-13-01(SysA:VE)
		Assigned	On	Not Assigned		Off	21-13-01(SysA:VE)		
				Assigned		On	21-13-01(SysA:VE)		
				Assigned		Off	21-13-01(SysA:VE)		
			Not Assigned	Assigned	Not Assigned	Off	Not Assigned	Off	None *
							Assigned	On	None *
							Assigned	Off	21-12-01 (SysB)
		Assigned			On	Not Assigned	Off	21-12-01 (SysB)	
						Assigned	On	21-12-01 (SysB)	
						Assigned	Off	21-13-01(SysA:VE)	
		Assigned		Off	Assigned	Off	Not Assigned	On	21-13-01(SysA:VE)
							Assigned	Off	21-13-01(SysA:VE)
							Assigned	On	21-13-01(SysA:VE)
Assigned	On			Assigned	On	Not Assigned	Off	21-13-01(SysA:VE)	
						Assigned	On	21-13-01(SysA:VE)	
						Assigned	Off	21-13-01(SysA:VE)	
	Assigned	On	Assigned	On	Not Assigned	On	21-13-01(SysA:VE)		
					Assigned	Off	21-13-01(SysA:VE)		
					Assigned	On	21-13-01(SysA:VE)		

Table 2-28 CPN for CCIS VE Standard Calls (Continued)

System A					System B			CPN: PRG
PRG 99-01-58	PRG 20-08-13	PRG 21-12-01	PRG 21-13-01		PRG 20-08-13	PRG 21-12-01	PRG 14-01-24	
			Terminal	VE				
On	On	Assigned	Not Assigned	Not Assigned	Off	Not Assigned	Off	21-12-01 (SysA)
						Assigned	On	21-12-01 (SysA)
						Assigned	Off	21-12-01 (SysA)
					Assigned	On	21-12-01 (SysA)	
					Assigned	Off	21-12-01 (SysA)	
					Assigned	On	21-12-01 (SysA)	
			Assigned	Off	Not Assigned	Off	21-13-01(SysA:VE)	
					Assigned	On	21-13-01(SysA:VE)	
					Assigned	Off	21-13-01(SysA:VE)	
				On	Not Assigned	Off	21-13-01(SysA:VE)	
					Assigned	On	21-13-01(SysA:VE)	
					Assigned	Off	21-13-01(SysA:VE)	
		Assigned	Not Assigned	Off	Not Assigned	Off	21-12-01 (SysA)	
					Assigned	On	21-12-01 (SysA)	
					Assigned	Off	21-12-01 (SysA)	
				On	Not Assigned	Off	21-12-01 (SysA)	
					Assigned	On	21-12-01 (SysA)	
					Assigned	Off	21-12-01 (SysA)	
			Assigned	Off	Not Assigned	Off	21-13-01(SysA:VE)	
					Assigned	On	21-13-01(SysA:VE)	
					Assigned	Off	21-13-01(SysA:VE)	
				On	Not Assigned	Off	21-13-01(SysA:VE)	
					Assigned	On	21-13-01(SysA:VE)	
					Assigned	Off	21-13-01(SysA:VE)	

\* The CPN provided is from the service provider.

Figure 2-24 CCIS 911 Calls

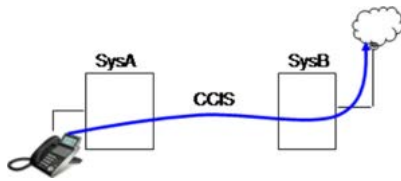

Table 2-29 CPN for CCIS 911 Calls

System A				System B			CPN: PRG		
PRG 99-01-58	PRG 20-08-13	PRG 21-12-01	PRG 21-13-01	PRG 20-08-13	PRG 21-12-01	PRG 14-01-24			
Off	Off	Not Assigned	Not Assigned	Off	Not Assigned	Off	None *		
					Assigned	On	None *		
					Assigned	Off	21-12-01 (SysB)		
				Assigned	On	21-12-01 (SysB)			
				On	Not Assigned	Off	None *		
					Assigned	On	None *		
			Assigned		Off	21-12-01 (SysB)			
			Assigned	Off	Assigned	Not Assigned	Off	21-13-01 (SysA)	
						Assigned	On	21-13-01 (SysA)	
						Assigned	Off	21-13-01 (SysA)	
				On	Not Assigned	On	21-13-01 (SysA)		
					Assigned	Off	21-13-01 (SysA)		
		Assigned			On	21-13-01 (SysA)			
		Assigned	Not Assigned	Off	Not Assigned	Not Assigned	Off	21-12-01 (SysA)	
						Assigned	On	21-12-01 (SysA)	
						Assigned	Off	21-12-01 (SysA)	
				On	Not Assigned	Off	21-12-01 (SysA)		
					Assigned	On	21-12-01 (SysA)		
					Assigned	Off	21-12-01 (SysA)		
			Assigned	Off	Assigned	Assigned	Not Assigned	Off	21-13-01 (SysA)
							Assigned	On	21-13-01 (SysA)
							Assigned	Off	21-13-01 (SysA)
				On	Not Assigned	On	21-13-01 (SysA)		
					Assigned	Off	21-13-01 (SysA)		
Assigned	On				21-13-01 (SysA)				

Table 2-29 CPN for CCIS 911 Calls (Continued)

System A				System B			CPN: PRG
PRG 99-01-58	PRG 20-08-13	PRG 21-12-01	PRG 21-13-01	PRG 20-08-13	PRG 21-12-01	PRG 14-01-24	
Off	On	Not Assigned	Not Assigned	Off	Not Assigned	Off	None *
					Assigned	On	None *
				Assigned	Off	21-12-01 (SysB)	
				Assigned	On	21-12-01 (SysB)	
				On	Not Assigned	Off	None *
				On	Assigned	On	None *
			Assigned	Off	Not Assigned	Off	21-12-01 (SysB)
					Assigned	On	21-12-01 (SysB)
				On	Not Assigned	Off	21-12-01 (SysB)
					Assigned	On	21-12-01 (SysB)
				Off	Not Assigned	Off	21-13-01 (SysA)
					Assigned	On	21-13-01 (SysA)
		Assigned	On	Not Assigned	Off	21-13-01 (SysA)	
				Assigned	On	21-13-01 (SysA)	
			Off	Not Assigned	Off	21-13-01 (SysA)	
				Assigned	On	21-13-01 (SysA)	
			On	Not Assigned	Off	21-13-01 (SysA)	
				Assigned	On	21-13-01 (SysA)	
		Assigned	Not Assigned	Off	Not Assigned	Off	21-12-01 (SysA)
					Assigned	On	21-12-01 (SysA)
				On	Not Assigned	Off	21-12-01 (SysA)
					Assigned	On	21-12-01 (SysA)
				Off	Not Assigned	Off	21-12-01 (SysA)
					Assigned	On	21-12-01 (SysA)
Assigned	Off		Not Assigned	Off	21-12-01 (SysA)		
			Assigned	On	21-12-01 (SysA)		
	On		Not Assigned	Off	21-12-01 (SysA)		
			Assigned	On	21-12-01 (SysA)		
	Off		Not Assigned	Off	21-13-01 (SysA)		
			Assigned	On	21-13-01 (SysA)		
On	Not Assigned	Off	21-13-01 (SysA)				
	Assigned	On	21-13-01 (SysA)				

Table 2-29 CPN for CCIS 911 Calls (Continued)

System A				System B			CPN: PRG			
PRG 99-01-58	PRG 20-08-13	PRG 21-12-01	PRG 21-13-01	PRG 20-08-13	PRG 21-12-01	PRG 14-01-24				
On	Off	Not Assigned	Not Assigned	Off	Not Assigned	Off	None *			
					Assigned	On	None *			
					Assigned	Off	21-12-01 (SysB)			
				Assigned	On	21-12-01 (SysB)				
				On	Not Assigned	Off	None *			
					Assigned	On	None *			
			Assigned		Off	21-12-01 (SysB)				
			Assigned	Off	Assigned	Off	Not Assigned	Off	21-12-01 (SysB)	
							Assigned	On	21-12-01 (SysB)	
							Assigned	On	21-12-01 (SysB)	
				On	Assigned	Assigned	Off	Not Assigned	Off	21-13-01 (SysA)
								Assigned	On	21-13-01 (SysA)
		Assigned						On	21-13-01 (SysA)	
		Assigned	Not Assigned	Off	Not Assigned	Not Assigned	Off	21-13-01 (SysA)		
						Assigned	On	21-13-01 (SysA)		
						Assigned	On	21-13-01 (SysA)		
				On	Not Assigned	Assigned	Off	Not Assigned	Off	21-13-01 (SysA)
								Assigned	On	21-13-01 (SysA)
								Assigned	On	21-13-01 (SysA)
			Assigned	Off	Assigned	Not Assigned	Not Assigned	Off	21-13-01 (SysA)	
							Assigned	On	21-13-01 (SysA)	
							Assigned	On	21-13-01 (SysA)	
				On	Assigned	Assigned	Off	Not Assigned	Off	21-13-01 (SysA)
								Assigned	On	21-13-01 (SysA)
Assigned	On							21-13-01 (SysA)		

Table 2-29 CPN for CCIS 911 Calls (Continued)

System A				System B			CPN: PRG
PRG 99-01-58	PRG 20-08-13	PRG 21-12-01	PRG 21-13-01	PRG 20-08-13	PRG 21-12-01	PRG 14-01-24	
On	On	Not Assigned	Not Assigned	Off	Not Assigned	Off	None *
					Assigned	On	None *
					Assigned	Off	21-12-01 (SysB)
				Assigned	On	21-12-01 (SysB)	
				On	Not Assigned	Off	None *
				On	Assigned	Off	21-12-01 (SysB)
			Assigned	Off	Not Assigned	Off	21-13-01 (SysA)
					Assigned	On	21-13-01 (SysA)
					Assigned	Off	21-13-01 (SysA)
				On	Not Assigned	Off	21-13-01 (SysA)
					Assigned	On	21-13-01 (SysA)
					Assigned	Off	21-13-01 (SysA)
		Assigned	Not Assigned	Off	Not Assigned	Off	21-12-01 (SysA)
					Assigned	On	21-12-01 (SysA)
					Assigned	Off	21-12-01 (SysA)
				On	Not Assigned	Off	21-12-01 (SysA)
					Assigned	On	21-12-01 (SysA)
					Assigned	Off	21-12-01 (SysA)
			Assigned	Off	Not Assigned	Off	21-13-01 (SysA)
					Assigned	On	21-13-01 (SysA)
					Assigned	Off	21-13-01 (SysA)
				On	Not Assigned	Off	21-13-01 (SysA)
					Assigned	On	21-13-01 (SysA)
					Assigned	Off	21-13-01 (SysA)

\* The CPN provided is from the service provider.

Figure 2-25 CCIS VE 911 Calls

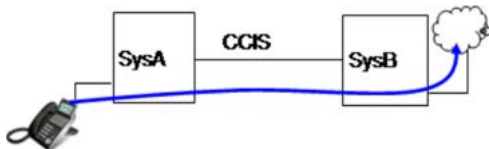



CPN sent when making a 911 call across CCIS trunks from a Virtual Extension (VE).

Table 2-30 CPN for CCIS VE 911 Calls

System A					System B			CPN: PRG	
PRG 99-01-58	PRG 20-08-13	PRG 21-12-01	PRG 21-13-01		PRG 20-08-13	PRG 21-12-01	PRG 14-01-24		
			Terminal	VE					
Off	Off	Not Assigned	Not Assigned	Off	Not Assigned	Off	Off	None *	
						On	On	None *	
					Assigned	Off	21-12-01(SysB)		
						On	21-12-01(SysB)		
					On	Not Assigned	Off	None *	
						Assigned	On	None *	
				Assigned	Off	21-12-01(SysB)			
					On	21-12-01(SysB)			
				Assigned	Assigned	Off	Not Assigned	Off	21-13-01(SysA:VE)
								On	21-13-01(SysA:VE)
							Assigned	Off	21-13-01(SysA:VE)
						On		21-13-01(SysA:VE)	
		On	Not Assigned			Off	21-13-01(SysA:VE)		
			Assigned			On	21-13-01(SysA:VE)		
		Assigned	Assigned	Not Assigned	Not Assigned	Off	Not Assigned	Off	None *
								On	None *
							Assigned	Off	21-12-01(SysB)
						On		21-12-01(SysB)	
						On	Not Assigned	Off	None *
								On	None *
				Assigned	Off		21-12-01(SysB)		
				Assigned	Assigned	Off	Not Assigned	Off	21-13-01(SysA:VE)
								On	21-13-01(SysA:VE)
							Assigned	Off	21-13-01(SysA:VE)
On	21-13-01(SysA:VE)								
On	Not Assigned					Off	21-13-01(SysA:VE)		
	Assigned	On	21-13-01(SysA:VE)						

Table 2-30 CPN for CCIS VE 911 Calls (Continued)

System A					System B			CPN: PRG			
PRG 99-01-58	PRG 20-08-13	PRG 21-12-01	PRG 21-13-01		PRG 20-08-13	PRG 21-12-01	PRG 14-01-24				
			Terminal	VE							
Off	Off	Assigned	Not Assigned	Not Assigned	Off	Not Assigned	Off	21-12-01(SysA)			
						On	On	21-12-01(SysA)			
						Assigned	Off	21-12-01(SysA)			
					On	On	21-12-01(SysA)				
					On	Not Assigned	Off	21-12-01(SysA)			
						On	On	21-12-01(SysA)			
				Assigned		Off	21-12-01(SysA)				
				Assigned	Off	Not Assigned	Assigned	Off	Not Assigned	Off	21-13-01(SysA:VE)
									On	On	21-13-01(SysA:VE)
									Assigned	Off	21-13-01(SysA:VE)
					On	Not Assigned		Off	21-13-01(SysA:VE)		
						On		On	21-13-01(SysA:VE)		
		Assigned	Off			21-13-01(SysA:VE)					
		Assigned	Assigned	Not Assigned	Not Assigned	Off	Not Assigned	Off	21-12-01(SysA)		
							On	On	21-12-01(SysA)		
							Assigned	Off	21-12-01(SysA)		
						On	Not Assigned	Off	21-12-01(SysA)		
							On	On	21-12-01(SysA)		
							Assigned	Off	21-12-01(SysA)		
				Assigned	Off	Not Assigned	Assigned	Off	Not Assigned	Off	21-13-01(SysA:VE)
									On	On	21-13-01(SysA:VE)
									Assigned	Off	21-13-01(SysA:VE)
					On	Not Assigned		Off	21-13-01(SysA:VE)		
						On		On	21-13-01(SysA:VE)		
Assigned	Off					21-13-01(SysA:VE)					

Table 2-30 CPN for CCIS VE 911 Calls (Continued)

System A					System B			CPN: PRG				
PRG 99-01-58	PRG 20-08-13	PRG 21-12-01	PRG 21-13-01		PRG 20-08-13	PRG 21-12-01	PRG 14-01-24					
			Terminal	VE								
Off	On	Not Assigned	Not Assigned	Off	Not Assigned	Off	Off	None *				
					Not Assigned	On	On	None *				
					Assigned	Off	Off	21-12-01(SysB)				
					Assigned	On	On	21-12-01(SysB)				
					Not Assigned	Off	Off	None *				
					Not Assigned	On	On	None *				
				On	Not Assigned	Off	Off	21-12-01(SysB)				
					Not Assigned	On	On	21-12-01(SysB)				
					Assigned	Off	Off	21-12-01(SysB)				
					Assigned	On	On	21-12-01(SysB)				
					Not Assigned	Off	Off	21-13-01(SysA:VE)				
					Not Assigned	On	On	21-13-01(SysA:VE)				
		Assigned	Assigned	Off	Assigned	Off	Not Assigned	Off	Off	21-13-01(SysA:VE)		
							Not Assigned	On	On	21-13-01(SysA:VE)		
							Assigned	Off	Off	21-13-01(SysA:VE)		
						On	Not Assigned	Off	Off	21-13-01(SysA:VE)		
							Not Assigned	On	On	21-13-01(SysA:VE)		
							Assigned	Off	Off	21-13-01(SysA:VE)		
				On	Assigned	Assigned	Assigned	Off	Not Assigned	Off	Off	21-13-01(SysA:VE)
									Not Assigned	On	On	21-13-01(SysA:VE)
									Assigned	Off	Off	21-13-01(SysA:VE)
								On	Not Assigned	Off	Off	21-13-01(SysA:VE)
									Not Assigned	On	On	21-13-01(SysA:VE)
									Assigned	Off	Off	21-13-01(SysA:VE)
Assigned	Assigned	Assigned	Assigned	On	Not Assigned	Off	Off	21-13-01(SysA:VE)				
					Not Assigned	On	On	21-13-01(SysA:VE)				
					Assigned	Off	Off	21-13-01(SysA:VE)				
					Assigned	On	On	21-13-01(SysA:VE)				
					Assigned	Off	Off	21-13-01(SysA:VE)				
					Assigned	On	On	21-13-01(SysA:VE)				

Table 2-30 CPN for CCIS VE 911 Calls (Continued)

System A					System B			CPN: PRG
PRG 99-01-58	PRG 20-08-13	PRG 21-12-01	PRG 21-13-01		PRG 20-08-13	PRG 21-12-01	PRG 14-01-24	
			Terminal	VE				
Off	On	Assigned	Not Assigned	Not Assigned	Off	Not Assigned	Off	21-12-01(SysA)
						On	On	21-12-01(SysA)
						Assigned	Off	21-12-01(SysA)
					On	On	21-12-01(SysA)	
					Not Assigned	Off	21-12-01(SysA)	
					Assigned	On	21-12-01(SysA)	
			Assigned	Off	Not Assigned	Off	21-13-01(SysA:VE)	
					On	On	21-13-01(SysA:VE)	
					Assigned	Off	21-13-01(SysA:VE)	
				On	Not Assigned	Off	21-13-01(SysA:VE)	
					On	On	21-13-01(SysA:VE)	
					Assigned	Off	21-13-01(SysA:VE)	
		Assigned	Not Assigned	Off	Not Assigned	Off	21-12-01(SysA)	
					On	On	21-12-01(SysA)	
					Assigned	Off	21-12-01(SysA)	
				On	Not Assigned	Off	21-12-01(SysA)	
					On	On	21-12-01(SysA)	
					Assigned	Off	21-12-01(SysA)	
			Assigned	Off	Not Assigned	Off	21-13-01(SysA:VE)	
					On	On	21-13-01(SysA:VE)	
					Assigned	Off	21-13-01(SysA:VE)	
				On	Not Assigned	Off	21-13-01(SysA:VE)	
					On	On	21-13-01(SysA:VE)	
					Assigned	Off	21-13-01(SysA:VE)	

Table 2-30 CPN for CCIS VE 911 Calls (Continued)

System A					System B			CPN: PRG						
PRG 99-01-58	PRG 20-08-13	PRG 21-12-01	PRG 21-13-01		PRG 20-08-13	PRG 21-12-01	PRG 14-01-24							
			Terminal	VE										
On	Off	Not Assigned	Not Assigned	Not Assigned	Off	Not Assigned	Off	None *						
							On	None *						
							Assigned	Off	21-12-01(SysB)					
				On		21-12-01(SysB)								
				Assigned		On	Not Assigned	Off	None *					
								On	None *					
			Assigned		Off			21-12-01(SysB)						
			On	21-12-01(SysB)										
			Assigned	Not Assigned	Off	Not Assigned	Off	Not Assigned	Off	21-13-01(SysA:VE)				
									On	21-13-01(SysA:VE)				
									Assigned	Off	21-13-01(SysA:VE)			
						On		21-13-01(SysA:VE)						
						Assigned		On	Not Assigned	Assigned	On	Not Assigned	Off	21-13-01(SysA:VE)
													On	21-13-01(SysA:VE)
			Assigned	Off	21-13-01(SysA:VE)									
			On	21-13-01(SysA:VE)										
			Assigned	Not Assigned	Off	Not Assigned	Off	Not Assigned	Off	21-13-01 (SysA:terminal)				
									On	21-13-01 (SysA:terminal)				
									Assigned	Off	21-13-01 (SysA:terminal)			
						On		21-13-01 (SysA:terminal)						
						Assigned		On	Not Assigned	Assigned	On	Not Assigned	Off	21-13-01 (SysA:terminal)
													On	21-13-01 (SysA:terminal)
			Assigned	Off	21-13-01 (SysA:terminal)									
			On	21-13-01 (SysA:terminal)										
Assigned	Not Assigned	Off	Not Assigned	Off	Not Assigned	Off	21-13-01 (SysA:terminal)							
						On	21-13-01 (SysA:terminal)							
						Assigned	Off	21-13-01 (SysA:terminal)						
			On		21-13-01 (SysA:terminal)									
			Assigned		On	Not Assigned	Assigned	On	Not Assigned	Off	21-13-01 (SysA:terminal)			
										On	21-13-01 (SysA:terminal)			
Assigned	Off	21-13-01 (SysA:terminal)												
On	21-13-01 (SysA:terminal)													

Table 2-30 CPN for CCIS VE 911 Calls (Continued)

System A					System B			CPN: PRG
PRG 99-01-58	PRG 20-08-13	PRG 21-12-01	PRG 21-13-01		PRG 20-08-13	PRG 21-12-01	PRG 14-01-24	
			Terminal	VE				
On	Off	Assigned	Not Assigned	Not Assigned	Off	Not Assigned	Off	21-12-01(SysA)
						On	On	21-12-01(SysA)
						Assigned	Off	21-12-01(SysA)
					On	On	21-12-01(SysA)	
					Not Assigned	Off	21-12-01(SysA)	
					Assigned	On	21-12-01(SysA)	
				Assigned	Off	Not Assigned	Off	21-13-01(SysA:VE)
						On	On	21-13-01(SysA:VE)
						Assigned	Off	21-13-01(SysA:VE)
					On	Not Assigned	Off	21-13-01(SysA:VE)
						On	On	21-13-01(SysA:VE)
						Assigned	Off	21-13-01(SysA:VE)
		Assigned	Not Assigned	Off	Not Assigned	Not Assigned	Off	21-13-01 (SysA:terminal)
						On	On	21-13-01 (SysA:terminal)
						Assigned	Off	21-13-01 (SysA:terminal)
				On		On	21-13-01 (SysA:terminal)	
				Not Assigned		Off	21-13-01 (SysA:terminal)	
				Assigned		On	21-13-01 (SysA:terminal)	
			Assigned	Off	Not Assigned	Off	21-13-01 (SysA:terminal)	
					On	On	21-13-01 (SysA:terminal)	
					Assigned	Off	21-13-01 (SysA:terminal)	
				On	Not Assigned	Off	21-13-01 (SysA:terminal)	
					On	On	21-13-01 (SysA:terminal)	
					Assigned	Off	21-13-01 (SysA:terminal)	

Table 2-30 CPN for CCIS VE 911 Calls (Continued)

System A					System B			CPN: PRG	
PRG 99-01-58	PRG 20-08-13	PRG 21-12-01	PRG 21-13-01		PRG 20-08-13	PRG 21-12-01	PRG 14-01-24		
			Terminal	VE					
On	On	Not Assigned	Not Assigned	Not Assigned	Off	Not Assigned	Off	None *	
						Assigned	On	None *	
						Assigned	Off	21-12-01(SysB)	
					Assigned	On	21-12-01(SysB)		
					Not Assigned	Off	None *		
					Assigned	On	None *		
				Assigned	Off	Not Assigned	Off	21-12-01(SysB)	
						Assigned	On	21-12-01(SysB)	
						Assigned	On	21-12-01(SysB)	
					On	Not Assigned	Off	21-13-01(SysA:VE)	
						Assigned	On	21-13-01(SysA:VE)	
						Assigned	On	21-13-01(SysA:VE)	
		Assigned	Not Assigned	Not Assigned	Not Assigned	Off	Not Assigned	Off	21-13-01(SysA:terminal)
							Assigned	On	21-13-01(SysA:terminal)
							Assigned	Off	21-13-01(SysA:terminal)
						On	Not Assigned	On	21-13-01(SysA:terminal)
							Assigned	Off	21-13-01(SysA:terminal)
							Assigned	On	21-13-01(SysA:terminal)
				Assigned	Off	Not Assigned	Off	21-13-01(SysA:terminal)	
						Assigned	On	21-13-01(SysA:terminal)	
						Assigned	On	21-13-01(SysA:terminal)	
					On	Not Assigned	Off	21-13-01(SysA:terminal)	
						Assigned	On	21-13-01(SysA:terminal)	
						Assigned	On	21-13-01(SysA:terminal)	

Table 2-30 CPN for CCIS VE 911 Calls (Continued)

System A					System B			CPN: PRG
PRG 99-01-58	PRG 20-08-13	PRG 21-12-01	PRG 21-13-01		PRG 20-08-13	PRG 21-12-01	PRG 14-01-24	
			Terminal	VE				
On	On	Assigned	Not Assigned	Not Assigned	Off	Not Assigned	Off	21-12-01(SysA)
						Assigned	On	21-12-01(SysA)
						Assigned	Off	21-12-01(SysA)
					On	Not Assigned	On	21-12-01(SysA)
						Assigned	Off	21-12-01(SysA)
						Assigned	On	21-12-01(SysA)
				Assigned	Off	Not Assigned	Off	21-13-01(SysA:VE)
						Assigned	On	21-13-01(SysA:VE)
						Assigned	Off	21-13-01(SysA:VE)
					On	Not Assigned	On	21-13-01(SysA:VE)
						Assigned	Off	21-13-01(SysA:VE)
						Assigned	On	21-13-01(SysA:VE)
		Assigned	Assigned	Not Assigned	Off	Not Assigned	Off	21-13-01 (SysA:terminal)
						Assigned	On	21-13-01 (SysA:terminal)
						Assigned	Off	21-13-01 (SysA:terminal)
					On	Not Assigned	On	21-13-01 (SysA:terminal)
						Assigned	Off	21-13-01 (SysA:terminal)
						Assigned	On	21-13-01 (SysA:terminal)
				Assigned	Off	Not Assigned	Off	21-13-01 (SysA:terminal)
						Assigned	On	21-13-01 (SysA:terminal)
						Assigned	Off	21-13-01 (SysA:terminal)
					On	Not Assigned	On	21-13-01 (SysA:terminal)
						Assigned	Off	21-13-01 (SysA:terminal)
						Assigned	On	21-13-01 (SysA:terminal)

\* The CPN provided is from the service provider.



CPN sent when making a 911 call from a terminal by pressing a CO Line Key and then dialing 911.

Table 2-31 CPN for Line Key+911 Calls

PRG 99-01-58	PRG 20-08-13	PRG 21-12-01	PRG 21-13-01	CPN: PRG
Off	Off	Not Assigned	Not Assigned	None *
			Assigned	None *
		Assigned	Not Assigned	21-12-01
			Assigned	21-12-01
	On	Not Assigned	Not Assigned	None *
			Assigned	21-13-01
		Assigned	Not Assigned	21-12-01
			Assigned	21-13-01
On	Off	Not Assigned	Not Assigned	None *
			Assigned	None *
		Assigned	Not Assigned	21-12-01
			Assigned	21-12-01
	On	Not Assigned	Not Assigned	None *
			Assigned	21-13-01
		Assigned	Not Assigned	21-12-01
			Assigned	21-13-01

\* The CPN provided is from the service provider.

### Default Settings

Disabled

### System Availability

#### Terminals

None

#### Required Component(s)

None

## Related Features

- **Automatic Route Selection (ARS)**
- **Central Office Calls, Placing**
- **T1 Trunking (with ANI/DNIS Compatibility)**
- **ISDN Compatibility**

## Guide to Feature Programming

The **Level 1**, **Level 2** and **Level 3** columns indicate the programs that are assigned when programming this feature in the order they are most commonly used. These levels are used with PCPro and WebPro wizards for feature programming.

- Level 1 – these are the most commonly assigned programs for this feature.
- Level 2 – these are the next most commonly assigned programs for this feature.
- Level 3 – these programs are not often assigned and require an expert level working knowledge of the system to be properly assigned.

Program Number	Program Name/Description	Input Data	Default	Level		
				1	2	3
11-12-56	<b>Service Code Setup (for Service Access) – E911 Alarm Shut Off</b> Select the Service Code (normally 786) that an extension user can dial to shut off the E911 Alarm Ring. ➤ <i>The EXIT key must be used to clear the E911 Display Alarm.</i>	MLT 0 ~ 9, *, # Maximum of eight digits	786		✓	
14-05-01	<b>Trunk Group – Trunk Group Number</b> Assign the outbound trunks you want to use for E911 service to the same Trunk Group.	Trunk Port 1 ~ 400 Group Number 0 ~ 100 Priority 1 ~ 400	Default = Trunks 1 ~ 400 assigned to trunk group 1 with priorities equal to the trunk number. Trunk 1 = Priority 1 Trunk 400 = Priority 400.		✓	
14-06-01	<b>Trunk Group Routing – Priority Order Number</b> Set the priority order number 1 ~ 4.	0 = Not Set 001 ~ 100 = Trunk group No. 101 ~ 150 = 100 + Networking System No. 1001 ~ 1100 = 1000 + Route Table No.	Route 1, Order Number 1 = 1 (Trunk Group 1) Order Numbers 2, 3, 4 = 0 (Not Specified) All Other Routes (2 ~ 100) and Order Numbers (1 ~ 4) = 0 (Not Specified).	✓		

Program Number	Program Name/Description	Input Data	Default	Level		
				1	2	3
20-06-01	<b>Class of Service for Extensions</b> Assign a Class of Service to an extension (1 ~ 15).	Day Night/Mode: 1 ~ 8 Class of Service of Extensions (1 ~ 15)	Extension port 101 = Class 15 All other extension port = Class 1		✓	
20-08-16	<b>Class of Service Options (Outgoing Call Service) – Display E911 Dialed Extension Name and Number</b> Turn Off or On an extension ability to display the name and number of the extension that dialed 911.	0 = Off 1 = On	COS 1 ~ 15 = 0		✓	
21-01-12	<b>System Options for Outgoing Calls – Dial E911 Routing Without Trunk Access</b> If Enabled (1), an extension user can dial 911 without first dialing a trunk access code or pressing a line key. If Disabled (0), an extension user must dial a trunk access code (e.g., 9) or press a line key before dialing 911. If enabled, dialing 9+911 # still dials out.	0 = Trunk Access Code Required 1 = Trunk Access Code Not Required	1		✓	
21-01-13	<b>System Options for Outgoing Calls – Alarm Ring Timer (E911)</b> Set the duration of the E911 Alarm Ring Time. If set to 0, the E911 Alarm does not ring.	0 ~ 64800 seconds	0		✓	
21-02-01	<b>Trunk Group Routing for Extensions</b> Assign the routes set in Program 14-06 to extensions. This program and Program 14-06 are the minimum required if E911 must seize a line to dial.	1 ~ 100 (Trunk Groups) 0 ~ 100 (0 = No Setting)	1	✓		

**Calling Party Number Presentation:**

Program Number	Program Name/Description	Input Data	Default	Level		
				1	2	3
10-03-05	<b>ETU Setup (PRTA Pkg Setup) – CLIP Information</b> Based on this setting, the system includes a Presentation Allowed (1) or Presentation Restricted (0) in the Setup message to allow/deny the Calling Party Number. Program 15-01-04 must also be set to 1 if this option is enabled.	0 = Disable 1 = Enable	1		✓	
15-01-04	<b>Basic Extension Data Setup – ISDN Caller ID</b> If both Program 15-01-04 and Program 10-03-05 are Enabled, the system includes Caller ID in the Setup message as Presentation Allowed. If these options are Disabled, it is Presentation Restricted.	0 = Disable 1 = Enable	1		✓	

Program Number	Program Name/Description	Input Data	Default	Level		
				1	2	3
20-06-01	<b>Class of Service for Extensions</b> Assign a Class of Service (1 ~ 15) to an extension.	Day Night/Mode: 1 ~ 8 Class of Service of Extensions (1 ~ 15)	Extension port 101 = Class 15 All other extension port = Class 1	✓		
20-08-13	<b>Class of Service Options (Outgoing Call Service) – ISDN CLIP</b> Determine if the ISDN calling line identity presentation and screening indicators should be allowed.	0 = Off 1 = On	0	✓		
21-12-01	<b>ISDN Calling Party Number Setup for Trunks</b> Assign Calling Party Numbers for each trunk (maximum 16 digits per entry). When a call is made by an extension which does not have an Extension Calling Number assigned (Program 21-13), the system sends the calling number for the ISDN trunk defined in 21-12. If the Calling Party Number is assigned in both Program 21-12 and Program 21-13, the system sends the data in Program 21-13.	0 ~ 9, *, # Maximum of 16 digits	All Trunks = No Setting	✓		
21-13-01	<b>ISDN Calling Party Number Setup for Extensions</b> Assign each extension a Calling Party Number (maximum 16 digits per entry). The calling number is the subscriber number of the dial-in number. When a call is made by an extension which does not have an Extension Calling Number assigned (Program 21-12), the system sends the calling number for the ISDN trunk defined in Program 21-13. If a Calling Party Number is assigned in both Program 21-12 and Program 21-13, the system sends the data in Program 21-13.	0 ~ 9, *, # Maximum of 16 digits	No Setting	✓		

## Operation

### To place an emergency 911 call

When Dial 911 Routing Without Trunk Access is enabled:

1. Go to any telephone.
2. Lift the handset or press **Speaker**.
3. Dial **911**.

**When Dial 911 Routing Without Trunk Access is disabled:**

1. Go to any telephone.
2. Lift the handset or press **Speaker**.
3. Dial a trunk access code (e.g., 9) or press a line key.
4. Dial **911**.

**To turn off the E911 Alarm at your telephone:**

1. Lift the handset or press **Speaker**.
2. Dial **786**.
  - ◇ *The alarm goes off.*
  - **OR** - (if you have a display telephone)
1. Press the **Exit** key once to turn off the alarm.
2. Press the **Exit** key again to clear the alarm display.



## Facsimile CO Branch Connection



### Description

The UNIVERGE SV9100 system provides branch connection of locally provided facsimile machines to CO/PBX lines. Additional dedicated CO/PBX lines are not required for a facsimile to operate. The facsimile shares any CO/PBX line on the COI Package and Power Failure (PF) circuit.

### Conditions

- This function requires a GCD-4COTB Blade to connect a facsimile in branch to a direct CO/PBX line.
- A PF circuit is required. The GCD-4COTB has PF circuits on the first two ports.
- PF and FAX branch connection do not work together at the same port. Select either way in Program 14-02-21.
- For the FAX Branch Line, Incoming Group or DIL should be programmed.
- The systems cannot distinguish between an incoming facsimile call and a CO/PBX call. Incoming call may be automatically answered by FAX Machine. Ringing assignments should be turned off for fax lines.
- When the facsimile is used, the associated CO line key indicates Busy LED on a multiline terminal.
- When the facsimile is not used, the FAX Branch CO/PBX line can be used as an outside line.
- Code restriction does not apply to outgoing calls from the FAX machine.
- Connection of the facsimile machine does not require extra system ports.
- The GPZ-4COTF daughter board does not contain any Power Fail or FAX Branch Exchange circuits.
- Power Fail and FAX CO Branch Connection cannot be used on the same CO port at the same time.
- Program 14-02-21 must be used to set a CO port to use this feature.

### Default Settings

None

## System Availability

### Terminals

None

### Required Component(s)

GCD-4COTB

## Related Features

None

## Guide to Feature Programming

The **Level 1**, **Level 2** and **Level 3** columns indicate the programs that are assigned when programming this feature in the order they are most commonly used. These levels are used with PCPro and WebPro wizards for feature programming.

- Level 1 – these are the most commonly assigned programs for this feature.
- Level 2 – these are the next most commonly assigned programs for this feature.
- Level 3 – these programs are not often assigned and require an expert level working knowledge of the system to be properly assigned.

Program Number	Program Name/Description	Input Data	Default	Level		
				1	2	3
14-02-14	<b>Analog Trunk Data Setup – Loop Start/ Ground Start</b> Select Loop start or Ground start for the trunk.	0 = Loop Start (Loop) 1 = Ground Start (Ground)	0		✓	
14-02-21	<b>FAX Branch Connection</b> Set CO for Fax Branch Connection. ➡ <i>If FAX Branch is selected, Program 14-10 Power Failure Telephone Setting is NOT valid.</i>	0 = No 1 = Yes	0	✓		
14-05-01	<b>Trunk Group</b> Assign trunks to trunk groups (1 ~ 100).	Trunk Port 1 ~ 400 Group Number 0 ~ 100 Priority 1 ~ 400	Default = Trunks 1 ~ 400 assigned to trunk group 1 with priorities equal to the trunk number. Trunk 1 = Priority 1 Trunk 400 = Priority 400.		✓	



Program Number	Program Name/Description	Input Data	Default	Level		
				1	2	3
22-01-04	<p><b>System Options for Incoming Calls – DIL No Answer Recall Time</b></p> <p>A DIL that rings its programmed destination longer than this time, diverts to the DIL No Answer Ring Group (set in Program 22-08).</p>	0 ~ 64800 seconds	0		✓	
22-04-01	<p><b>Incoming Extension Ring Group Assignment</b></p> <p>Assign extensions (up to 48) to Ring Groups. Calls ring extensions according to Ring Group programming. There are 100 available ring groups.</p>	Maximum of eight digits.	Extensions 101 ~ 108 (first eight ports) ring for incoming Ring Group 1 calls. No other extensions ring for incoming Ring Group 1 calls.		✓	
22-05-01	<p><b>Incoming Trunk Ring Group Assignment</b></p> <p>To have the trunks ring extensions, assign trunks to a Ring Group. The incoming ring group assignment programmed in Program 41-03-01 overrides the setting in this program.</p>	Trunks 1 ~ 400 Incoming Group Number for Day/Night Mode (1 ~ 8): 0 = (No Setting) 001 ~ 100 = (Incoming Group) 102 = (In-Skin/ External Voice Mail or InMail)	1		✓	
22-08-01	<p><b>DIL/IRG No Answer Destination</b></p> <p>A DIL that rings its programmed destination longer than this time. diverts to the DIL No Answer Ring Group (set in Program 22-08).</p>	0 = (No Setting) 001 ~ 100 = Incoming Ring Group 102 = (In-Skin/ External Voice Mail or InMail)	1		✓	

## Operation

None

## Description

Flash allows an extension user to access certain CO and PBX features by interrupting the trunk loop current. Flash lets an extension user take full advantage of whatever features the connected Telco or PBX offers. You must set the Flash parameters for compatibility with the connected Telco or PBX.

### Conditions

- The system does not provide a ground flash.
- A Flash (Recall) key can be placed on a line key.

### Default Settings

Enabled

## System Availability

### Terminals

All Terminals

### Required Component(s)

None

## Related Features

- ➔ **Drop Key**
- ➔ **PBX Compatibility**
- ➔ **InMail**

## Guide to Feature Programming

The **Level 1**, **Level 2** and **Level 3** columns indicate the programs that are assigned when programming this feature in the order they are most commonly used. These levels are used with PCPro and WebPro wizards for feature programming.

- Level 1 – these are the most commonly assigned programs for this feature.
- Level 2 – these are the next most commonly assigned programs for this feature.
- Level 3 – these programs are not often assigned and require an expert level working knowledge of the system to be properly assigned.

Program Number	Program Name/Description	Input Data	Default	Level		
				1	2	3
11-12-42	<b>Service Code Setup (for Service Access) – Flash on Trunk Lines</b> Customize the Service Codes for flash on trunk lines.	SLT 0 ~ 9, *, # Maximum of eight digits	#3		✓	
14-02-03	<b>Analog Trunk Data Setup – Flash Type</b> Make sure this item is set for open loop Flash.	0 = Open Loop Flash 1 = Ground	0			✓
14-02-04	<b>Analog Trunk Data Setup – Hooking Type</b> For each trunk, select Timed Flash or open loop Disconnect.	0 = Timed Flash (Hooking) 1 = Disconnect (Cut)	0		✓	
14-04-01	<b>Behind PBX Setup</b> For each trunk, indicate if the trunk is installed behind a PBX.	0 = Stand Alone (Trunk) 1 = Behind PBX (PBX) 2 = Not Used 3 = CTX assume 9	0		✓	
15-02-05	<b>Multiline Telephone Basic Data Setup – Transfer Key Operation Mode</b> For the Cordless Lite/Cordless Lite II telephone user to use the flash function, this option must be set to 2. This changes the Transfer key to a Flash key.	0 = Transfer 1 = Serial Call 2 = Flash	0		✓	
15-03-04	<b>Single Line Telephone Basic Data Setup – Flashing</b> Enable/Disable Flash for single line (500/2500 type) telephones.	0 = No 1 = Yes	1		✓	

Program Number	Program Name/Description	Input Data	Default	Level		
				1	2	3
81-10-07	<b>COT Initial Data Setup – Hookflash Time Selection 1</b> Set the Flash duration (16 ~ 4080ms) for analog trunk GCD-4COTB circuits in Program 81-10-07.	0 = 20ms 1 = 40ms 2 = 60ms 3 = 80ms 4 = 100ms 5 = 140ms 6 = 160ms 7 = 200ms 8 = 400ms 9 = 600ms 10 = 800ms 11 = 1.0 seconds 12 = 1.5 seconds 13 = 2.0 seconds 14 = 3.0 seconds 15 = 5.0 seconds	9 = 600ms			✓
81-10-08	<b>COT Initial Data Setup – Hookflash Time Selection 2</b> Set the open loop disconnect duration (16 ~ 4080ms) for analog trunk GCD-4COTB circuits Program 81-10-08.	0 = 20ms 1 = 40ms 2 = 60ms 3 = 80ms 4 = 100ms 5 = 140ms 6 = 160ms 7 = 200ms 8 = 400ms 9 = 600ms 10 = 800ms 11 = 1.0 seconds 12 = 1.5 seconds 13 = 2.0 seconds 14 = 3.0 seconds 15 = 5.0 seconds	14 = 3.0 seconds			✓

## Operation

To flash the trunk you are on:

### From a Multiline Terminal

1. Press **Recall**.

### From a Single Line Telephone

1. Hookflash.
2. Dial **#3**.

## Flexible System Numbering

### Description

Flexible System Numbering lets you reassign the system port-to-extension assignments. This allows an employee to retain their extension number if they move to a different office. In addition, factory technicians can make comprehensive changes to your system number plan. You can have factory technicians:

- Set the number of digits in internal (Intercom) functions. For example, extension numbers can have up to eight digits.
- Change your system Service Code numbers.
- Assign single digit access to selected Service Codes.

Talk to your sales representative to find out if this program is available to you.

You can also use Flexible System Numbering to change the system Trunk Group Routing code. Although the default code of 9 is suitable for most applications, you can alter the code if needed.

The system provides a completely flexible system numbering plan. Refer to the chart below and the UNIVERGE SV9100 Programming Manual for more details.

Flexible System Numbering	
Program	Description
11-01-01 System Numbering	Set the system internal (Intercom) numbering plan. The numbering plan includes the digits an extension user must dial to access features and other extensions.
11-09-01 Trunk Access Code	Assign the single-digit trunk access code (normally 9). This is the code users dial to access Automatic Route Selection (ARS) or Trunk Group Routing.
11-20-01 Dial Extension Analyze Table	Use tables 01~128 to assign the digits to be dialed using the Dial Extension Analyze Tables. These tables are used when Program 11-01-01 is set to option 9 = Dial Extension Analyze. (Up to eight digits can be assigned and the valid entries are: 0, 1 ~ 9, #, *)
11-20-02 Dial Extension Analyze Table	Assign the Type of Dial for the Dial Extension Analyze Table from Program 11-20-01. (Svc Code, Intercom, Operator, or F-Route)

Flexible System Numbering (Continued)	
Program	Description
11-10 Service Code Setup (for System Administrator) 11-11 Service Code Setup (for Setup/Entry Operation) 11-12 Service Code Setup (for Service Access) 11-13 Service Code Setup (for ) 11-14 Service Code Setup (for Hotel) 11-15 Service Code Setup, Administrative (for Special Access)	Customize the Service Codes.
11-16 Single Digit Service Code Setup	Assign the Single Digit Service Codes. these are the post-dialing codes a user can dial after placing an Intercom call to a co-worker.

### Conditions

- Programming follows a telephone extension number, not the port number in most cases. If you relocate a telephone, you may need to change additional programming. For example, if you change the extension assigned to a port in Program 11-02, the line key programming does not follow. However, if you move the extension using the Station Relocation Feature, the line key programming does follow.
- Since making changes in Program 11-01 does not automatically make any other changes in any other program, changing the number plan after the system is in operation may cause problems in the following programs:

	Program 11-01 Type 2 (Extension Number)			Program 11-01 Type 1 (Service Codes)		
11-02	11-08	15-12	22-11	11-10	11-14	21-11
11-04	11-17	16-01-01	25-06	11-11	11-15	30-03
11-06	15-01-01	15-14	30-03	11-12	15-07	
11-07	15-07	21-11		11-13	15-14	
	0507, 0515, 0516, 0920, 1207, 2402, 2902, 2905, 2908			2402		

- Any feature which requires dialing a code or extension number can be affected.
- When the system searches the Dial Extension Analyze Table (Program 11-20-01), the system uses prefix searching, giving the lower table number the higher priority. For example, the user programs 211 in table 1 and 2113 in table 2, then dials 2113, the system selects table 1.

Example for 310X	Example for 3100X
10s Group (4-digit)	100s Group (5-digit)
11-01-01 = Dial 3 31 Digit 4 = (9)Dial Extension Analyze Table	11-01-01 = Dial 3 31 Digit 7 = (9)Dial Extension Analyze Table
11-20-01 Table 1 = Dial 310	11-20-01 Table 1 = Dial 3100
11-20-02 Table 1 = Intercom	11-20-02 Table 1 = Intercom

Example for 31000X	Example for 310000X
1000s Group (6-digit)	10,000s Group (7-digit)
11-01-01 = Dial 3 31 Digit 4 = (9)Dial Extension Analyze Table	11-01-01 = Dial 3 31 Digit 7 = (9)Dial Extension Analyze Table
11-20-01 Table 1 = Dial 31000	11-20-01 Table 1 = Dial 310000
11-20-02 Table 1 = Intercom	11-20-02 Table 1 = Intercom

### Default Settings

Extensions and Virtuals are numbered in the following order:

Program 11-02-01 and Program 11-04-01

- Physical Extensions:
  - Extn Port 1 = 101 ~ Extn Port 99 = 199
  - Extn Port 100 = 3101 ~ Extn Port 199 = 3200
  - Extn Port 200 = 3201 ~ Extn Port 960 = 3961
- Virtual Extensions/CAR Keys:
  - VE Port 1 = 201 ~ VE Port 99 = 299
  - VE Port 100 ~ 512 = No Setting

### System Availability

#### Terminals

All Terminals

## Required Component(s)

None

## Related Features

None

## Guide to Feature Programming

The **Level 1**, **Level 2** and **Level 3** columns indicate the programs that are assigned when programming this feature in the order they are most commonly used. These levels are used with PCPro and WebPro wizards for feature programming.

- Level 1 – these are the most commonly assigned programs for this feature.
- Level 2 – these are the next most commonly assigned programs for this feature.
- Level 3 – these programs are not often assigned and require an expert level working knowledge of the system to be properly assigned.

Program Number	Program Name/Description	Input Data	Default	Level		
				1	2	3
11-01-01	<b>System Numbering – Service Code</b> Customize the system internal (Intercom) numbering plan.		Refer to the Programming Manual for default values.	✓		
11-02-01	<b>Extension Numbering</b> Assign extension numbers to extension ports. The telephone programming identity follows the port number – not the extension number	Maximum of eight digits	1 ~ 99 : 101 ~ 199 100 ~ 199 : 3101 ~ 3200 200 ~ 960 : 3201 ~ 3961	✓		
11-04-01	<b>Virtual Extension Numbering</b> Assign virtual extension numbers.	Maximum of eight digits	Virtual Extension Port No. 1 ~ 99 = Virtual Extension Number 201 ~ 299 Other Virtual Extension Port = No Setting	✓		
11-06-01	<b>ACI Extension Numbering</b> Define the virtual extension number to be used for the ACI extension numbering.	Maximum of eight digits. ACI Ports: 1 ~ 96	No Setting		✓	
11-07-01	<b>Department Group Pilot Numbers – Dial</b> Assign pilot numbers to each Department Group set up.	Dial (maximum of eight digits)	No Setting	✓		



Program Number	Program Name/Description	Input Data	Default	Level		
				1	2	3
11-08-01	<b>ACI Group Pilot Number</b> Assign pilot numbers to ACI groups. When a user dials the pilot number, they reach an available ACI software port within the group.	Dial (maximum of eight digits). ACI Groups 1 ~ 16	No Setting		✓	
11-09-01	<b>Trunk Access Code</b> If required, change the single-digit Trunk Access Code (normally 9). If you change this code, you must also review the settings in Program 11-01-01 for the new code selected.	Dial (maximum of four digits)	9		✓	
11-09-02	<b>Trunk Access Code – 2nd Trunk Route Access Code</b> Assign the Service Code set up in Program 11-01-01 for Alternate Trunk Route Access.	Dial (maximum of four digits)	No Setting		✓	
11-10-01	<b>Service Code Setup (for System Administrator) – Night Mode Switching</b> Customize the night mode switching Service Codes for the System Administrator.	MLT, SLT 0 ~ 9, *, # Maximum of eight digits	718		✓	
11-10-03	<b>Service Code Setup (for System Administrator) – Setting the System Time</b> Customize the system time Service Codes for the System Administrator.	MLT 0 ~ 9, *, # Maximum of eight digits	728		✓	
11-10-04	<b>Service Code Setup (for System Administrator) – Storing Common Speed Dialing Numbers</b> Store common speed dialing Service Codes for the System Administrator.	MLT 0 ~ 9, *, # Maximum of eight digits	753		✓	
11-10-05	<b>Service Code Setup (for System Administrator) – Storing Group Speed Dialing Numbers</b> Store group speed dialing numbers for the System Administrator.	MLT 0 ~ 9, *, # Maximum of eight digits	754		✓	
11-10-06	<b>Service Code Setup (for System Administrator) – Setting the Automatic Transfer for Each Trunk Line</b> Set the service code for setting automatic transfer for each trunk line.	MLT 0 ~ 9, *, # Maximum of eight digits	733		✓	
11-10-07	<b>Service Code Setup (for System Administrator) – Canceling the Automatic Transfer for Each Trunk Line</b> Set the service code for canceling automatic transfer for each trunk line.	MLT 0 ~ 9, *, # Maximum of eight digits	734		✓	
11-10-08	<b>Service Code Setup (for System Administrator) – Setting the Destination for Automatic Trunk Transfer</b> Set the service code for setting the destination for automatic trunk transfer.	MLT 0 ~ 9, *, # Maximum of eight digits	735		✓	

Program Number	Program Name/Description	Input Data	Default	Level		
				1	2	3
11-10-12	<b>Service Code Setup (for System Administrator) – Night Mode Switching for Other Group</b> Customize the night mode switching for other group Service Codes for the System Administrator.	MLT 0 ~ 9, *, # Maximum of eight digits	618		✓	
11-10-16	<b>Service Code Setup (for System Administrator) – Leaving Message Waiting (Requires CPU to be licensed for Hotel/Motel)</b> Customize the leave message waiting Service Codes for the System Administrator (requires CPU to be licensed for Hotel/Motel).	MLT 0 ~ 9, *, # Maximum of eight digits	626		✓	
11-10-17	<b>Service Code Setup (for System Administrator) – Dial Block by Supervisor</b> Customize the supervisor dial block Service Codes for the System Administrator.	MLT 0 ~ 9, *, # Maximum of eight digits	601		✓	
11-10-18	<b>Service Code Setup (for System Administrator) – Off-Premise Call Forward by Door Box</b> Customize the night mode switching Service Codes for the System Administrator.	MLT 0 ~ 9, *, # Maximum of eight digits	722		✓	
11-10-20	<b>Service Code Setup (for System Administrator) – VRS - Record/Erase Message</b> Customize the night mode switching Service Codes for the System Administrator.	MLT, SLT 0 ~ 9, *, # Maximum of eight digits	616		✓	
11-10-21	<b>Service Code Setup (for System Administrator) – VRS - General Message Playback</b> Customize the VRS general message playback for the System Administrator.	MLT, SLT 0 ~ 9, *, # Maximum of eight digits	611		✓	
11-10-22	<b>Service Code Setup (for System Administrator) – VRS - Record or Erase General Message</b> Customize the VRS record or erase general message for the System Administrator.	MLT, SLT 0 ~ 9, *, # Maximum of eight digits	612		✓	
11-10-23	<b>Service Code Setup (for System Administrator) – SMDR - Extension Accumulated Printout Code</b> Customize the SMDR extension accumulated printout codes for the System Administrator.	MLT 0 ~ 9, *, # Maximum of eight digits	621		✓	
11-10-24	<b>Service Code Setup (for System Administrator) – SMDR - Group Accumulated Printout Code</b> Customize the SMDR group accumulated printouts for the System Administrator.	MLT 0 ~ 9, *, # Maximum of eight digits	622		✓	

Program Number	Program Name/Description	Input Data	Default	Level		
				1	2	3
11-10-25	<b>Service Code Setup (for System Administrator) – Account Code Accumulated Printout Code</b> Customize the account code accumulated printout Service Codes for the System Administrator.	MLT 0 ~ 9, *, # Maximum of eight digits	623		✓	
11-10-26	<b>Service Code Setup (for System Administrator) – Forced Trunk Disconnect</b> Customize the forced trunk disconnect Service Codes for the System Administrator.	MLT, SLT 0 ~ 9, *, # Maximum of eight digits	No Setting		✓	
11-10-27	<b>Service Code Setup (for System Administrator) – Trunk Port Disable for Outgoing Calls</b> Define the service code which should be used by an extension user to block a trunk from being used for outgoing calls.	MLT, SLT 0 ~ 9, *, # Maximum of eight digits	645		✓	
11-10-32	<b>Service Code Setup (for System Administrator) – Set Private Call Refuse</b> Customize the set private call refuse Service Codes for the System Administrator.	MLT, SLT 0 ~ 9, *, # Maximum of eight digits	No Setting		✓	
11-10-33	<b>Service Code Setup (for System Administrator) – Entry Caller ID Refuse</b> Customize the entry caller ID Service Codes for the System Administrator.	MLT 0 ~ 9, *, # Maximum of eight digits	No Setting		✓	
11-10-34	<b>Service Code Setup (for System Administrator) – Set Caller ID Refuse</b> Customize the set caller ID refuse Service Codes for the System Administrator.	MLT, SLT 0 ~ 9, *, # Maximum of eight digits	No Setting		✓	
11-10-35	<b>Service Code Setup (for System Administrator) – Dial-In Mode Switching</b> Customize the forced trunk disconnect Service Codes for the System Administrator.	MLT, SLT 0 ~ 9, *, # Maximum of eight digits	No Setting		✓	
11-10-36	<b>Service Code Setup (for System Administrator) – Change the Guidance Message Number on Voice Mail Auto Attendant</b> Change the guidance message number on voice mail auto attendant Service Codes for the System Administrator.	MLT, SLT 0 ~ 9, *, # Maximum of eight digits	No Setting		✓	
11-11-01	<b>Service Code Setup (for Setup/Entry Operation) – Call Forward – All</b> Set the service code for setting call forwarding all calls.	MLT, SLT 0 ~ 9, *, # Maximum of eight digits	741		✓	
11-11-02	<b>Service Code Setup (for Setup/Entry Operation) – Call Forward – Busy</b> Set the service code for setting call forwarding for busy calls.	MLT, SLT 0 ~ 9, *, # Maximum of eight digits	742		✓	

Program Number	Program Name/Description	Input Data	Default	Level		
				1	2	3
11-11-03	<b>Service Code Setup (for Setup/Entry Operation) – Call Forward – No Answer</b> Set the service code for setting call forwarding for no answer.	MLT, SLT 0 ~ 9, *, # Maximum of eight digits	743		✓	
11-11-04	<b>Service Code Setup (for Setup/Entry Operation) – Call Forward – Busy/No Answer</b> Set the service code for setting call forwarding for busy or no answer.	MLT, SLT 0 ~ 9, *, # Maximum of eight digits	744		✓	
11-11-05	<b>Service Code Setup (for Setup/Entry Operation) – Call Forward – Both Ring</b> Set the service code for setting call forwarding for busy or no answer.	MLT, SLT 0 ~ 9, *, # Maximum of eight digits	745		✓	
11-11-07	<b>Service Code Setup (for Setup/Entry Operation) – Call Forwarding – Follow Me</b> Set the service code for setting call forwarding for follow me.	MLT, SLT 0 ~ 9, *, # Maximum of eight digits	746		✓	
11-11-08	<b>Service Code Setup (for Setup/Entry Operation) – Do Not Disturb</b> Set the service code for setting call forwarding for Do Not Disturb.	MLT, SLT 0 ~ 9, *, # Maximum of eight digits	747		✓	
11-11-09	<b>Service Code Setup (for Setup/Entry Operation) – Answer Message Waiting</b> Customize the answer message waiting used for registration and setup.	MLT, SLT 0 ~ 9, *, # Maximum of eight digits	*0		✓	
11-11-10	<b>Service Code Setup (for Setup/Entry Operation) – Cancel All Messages Waiting</b> Cancel all messages waiting used for registration and setup.	MLT, SLT 0 ~ 9, *, # Maximum of eight digits	773		✓	
11-11-11	<b>Service Code Setup (for Setup/Entry Operation) – Cancel Message Waiting</b> Cancel message waiting used for registration and setup.	MLT, SLT 0 ~ 9, *, # Maximum of eight digits	771		✓	
11-11-12	<b>Service Code Setup (for Setup/Entry Operation) – Alarm Clock</b> Customize the alarm clock used for registration and setup.	MLT, SLT 0 ~ 9, *, # Maximum of eight digits	727		✓	
11-11-13	<b>Service Code Setup (for Setup/Entry Operation) – Display Language Selection for Multiline Terminal</b> Customize the display language for multiline terminal used for registration and setup.	MLT 0 ~ 9, *, # Maximum of eight digits	678		✓	
11-11-14	<b>Service Code Setup (for Setup/Entry Operation) – Text Message Setting</b> Customize the text message setting used for registration and setup.	MLT 0 ~ 9, *, # Maximum of eight digits	No Setting		✓	

Program Number	Program Name/Description	Input Data	Default	Level		
				1	2	3
11-11-15	<b>Service Code Setup (for Setup/Entry Operation) – Enable Handsfree Incoming Intercom Calls</b> Customize the enable handsfree incoming intercom calls used for registration and setup.	MLT 0 ~ 9, *, # Maximum of eight digits	721		✓	
11-11-16	<b>Service Code Setup (for Setup/Entry Operation) – Force Ringing of Incoming Intercom Calls</b> Customize the force ringing of incoming intercom calls used for registration and setup.	MLT 0 ~ 9, *, # Maximum of eight digits	723		✓	
11-11-17	<b>Service Code Setup (for Setup/Entry Operation) – Programmable Function Key Programming (2-Digit Service Codes)</b> Set the service code (default 751) to assign 2-digit function codes to the Function keys.	MLT 0 ~ 9, *, # Maximum of eight digits	751		✓	
11-11-18	<b>Service Code Setup (for Setup/Entry Operation) – BGM On/Off</b> Customize the BGM On/Off used for registration and setup.	MLT 0 ~ 9, *, # Maximum of eight digits	725		✓	
11-11-19	<b>Service Code Setup (for Setup/Entry Operation) – Key Touch Tone On/Off</b> Customize the key touch tone Off/On used for registration and setup.	MLT 0 ~ 9, *, # Maximum of eight digits	724		✓	
11-11-20	<b>Service Code Setup (for Setup/Entry Operation) – Change Incoming CO and ICM Ring Tones</b> Customize the change incoming CO and ICM ring tones used for registration and setup.	MLT 0 ~ 9, *, # Maximum of eight digits	720		✓	
11-11-21	<b>Service Code Setup (for Setup/Entry Operation) – Check Incoming Ring Tones</b> Check incoming ring tones used for registration and setup.	MLT 0 ~ 9, *, # Maximum of eight digits	711		✓	
11-11-22	<b>Service Code Setup (for Setup/Entry Operation) – Extension Name Programming</b> Customize the Extension name programming used for registration and setup.	MLT 0 ~ 9, *, # Maximum of eight digits	700		✓	
11-11-23	<b>Service Code Setup (for Setup/Entry Operation) – Second Call for DID/DISA/DIL</b> Customize the second call of DID/DISA/DIL used for registration and setup.	MLT 0 ~ 9, *, # Maximum of eight digits	679		✓	
11-11-24	<b>Service Code Setup (for Setup/Entry Operation) – Change Station Class of Service</b> Allow an extension user to change the COS of another extension. Must be allowed in Program 20-13-28.	MLT 0 ~ 9, *, # Maximum of eight digits	677		✓	

Program Number	Program Name/Description	Input Data	Default	Level		
				1	2	3
11-11-25	<b>Service Code Setup (for Setup/Entry Operation) – Automatic Transfer Setup for Each Extension Group</b> Customize the service code used to set the Automatic Trunk Forwarding feature for a Department Group.	MLT, SLT 0 ~ 9, *, # Maximum of eight digits	602		✓	
11-11-26	<b>Service Code Setup (for Setup/Entry Operation) – Automatic Transfer Cancellation for Each Extension Group</b> Customize the service code used to cancel the Automatic Trunk Forwarding feature for a Department Group.	MLT, SLT 0 ~ 9, *, # Maximum of eight digits	603		✓	
11-11-27	<b>Service Code Setup (for Setup/Entry Operation) – Destination of Automatic Transfer Each Extension Group</b> Customize the service code used to set the destination for the Automatic Trunk Forwarding feature for a Department Group.	MLT 0 ~ 9, *, # Maximum of eight digits	604		✓	
11-11-28	<b>Service Code Setup (for Setup/Entry Operation) – Delayed Transfer for Every Extension Group</b> Customize the delayed transfer for every extension group used for registration and setup.	MLT, SLT 0 ~ 9, *, # Maximum of eight digits	605		✓	
11-11-29	<b>Service Code Setup (for Setup/Entry Operation) – Delayed Transfer Cancellation for Each Extension Group</b> Customize the delayed transfer cancellation for each extension group used for registration and setup.	MLT, SLT 0 ~ 9, *, # Maximum of eight digits	606		✓	
11-11-30	<b>Service Code Setup (for Setup/Entry Operation) – DND Setup for Each Extension Group</b> Customize the Service Codes which are used for registration and setup.	MLT, SLT 0 ~ 9, *, # Maximum of eight digits	607		✓	
11-11-31	<b>Service Code Setup (for Setup/Entry Operation) – DND Cancellation for Each Extension Group</b> Customize the DND cancellation for each extension group used for registration and setup.	MLT, SLT 0 ~ 9, *, # Maximum of eight digits	608		✓	
11-11-33	<b>Service Code Setup (for Setup/Entry Operation) – Dial Block</b> Customize the dial block used for registration and setup.	MLT, SLT 0 ~ 9, *, # Maximum of eight digits	600		✓	
11-11-34	<b>Service Code Setup (for Setup/Entry Operation) – Temporary Toll Restriction Override</b> Customize the temporary toll restriction override used for registration and setup.	MLT, SLT 0 ~ 9, *, # Maximum of eight digits	775		✓	

Program Number	Program Name/Description	Input Data	Default	Level		
				1	2	3
11-11-35	<b>Service Code Setup (for Setup/Entry Operation) – Pilot Group Withdrawing</b> Customize the Service Codes which are used for registration and setup.	MLT, SLT 0 ~ 9, *, # Maximum of eight digits	650		✓	
11-11-36	<b>Service Code Setup (for Setup/Entry Operation) – Toll Restriction Override</b> Customize the toll restriction override used for registration and setup.	MLT, SLT 0 ~ 9, *, # Maximum of eight digits	663		✓	
11-11-37	<b>Service Code Setup (for Setup/Entry Operation) – Ring Volume Set</b> Customize the ring volume set used for registration and setup.	MLT 0 ~ 9, *, # Maximum of eight digits	729		✓	
11-11-38	<b>Service Code Setup (for Setup/Entry Operation) – Programmable Function Key Programming (3-Digit Service Codes)</b> Set the service code (default 752) to assign 3-digit function codes to the Function keys.	MLT 0 ~ 9, *, # Maximum of eight digits	752		✓	
11-11-39	<b>Service Code Setup (for Setup/Entry Operation) – Station Speed Dial Number Entry</b> Customize the station speed dial entry used for registration and setup.	MLT, SLT 0 ~ 9, *, # Maximum of eight digits	755		✓	
11-11-41	<b>Service Code Setup (for Setup/Entry Operation) – Tandem Ringing</b> Customize the tandem ringing used for registration and setup.	MLT, SLT 0 ~ 9, *, # Maximum of eight digits	No Setting		✓	
11-11-43	<b>Service Code Setup (for Setup/Entry Operation) – Headset Mode Switching</b> Customize the headset mode switching used for registration and setup.	MLT, SLT 0 ~ 9, *, # Maximum of eight digits	688		✓	
11-11-44	<b>Service Code Setup (for Setup/Entry Operation) – Auto Attendant</b> Customize the auto attendant used for registration and setup.	MLT, SLT 0 ~ 9, *, # Maximum of eight digits	No Setting		✓	
11-11-45	<b>Service Code Setup (for Setup/Entry Operation) – Set/Cancel Call Forward All (Split)</b> Assign the Call Forward All Split Service Code.	MLT, SLT 0 ~ 9, *, # Maximum of eight digits	No Setting		✓	
11-11-46	<b>Service Code Setup (for Setup/Entry Operation) – Set/Cancel Call Forward Busy (Split)</b> Assign the Call Forward Busy Split Service Code.	MLT, SLT 0 ~ 9, *, # Maximum of eight digits	No Setting		✓	
11-11-47	<b>Service Code Setup (for Setup/Entry Operation) – Set/Cancel Call Forward No Answer (Split)</b> Assign the Call Forward No Answer Split Service Code.	MLT, SLT 0 ~ 9, *, # Maximum of eight digits	No Setting		✓	



Program Number	Program Name/Description	Input Data	Default	Level		
				1	2	3
11-11-48	<b>Service Code Setup (for Setup/Entry Operation) – Set/Cancel Call Forward Busy No Answer (Split)</b> Assign the Call Forward Busy No Answer Split Service Code.	MLT, SLT 0 ~ 9, *, # Maximum of eight digits	No Setting		✓	
11-11-49	<b>Service Code Setup (for Setup/Entry Operation) – Set/Cancel Call Forward Both Ring (Split)</b> Assign the Call Forward Both Ring Split Service Code.	MLT, SLT 0 ~ 9, *, # Maximum of eight digits	No Setting		✓	
11-11-50	<b>Service Code Setup (for Setup/Entry Operation) – Set Message Waiting Indication</b> Customize the set message waiting indication used for registration and setup.	SLT 0 ~ 9, *, # Maximum of eight digits	No Setting		✓	
11-11-51	<b>Service Code Setup (for Setup/Entry Operation) – Cancel Message Waiting Indication</b> Customize the cancel message waiting indication used for registration and setup.	SLT 0 ~ 9, *, # Maximum of eight digits	No Setting		✓	
11-11-52	<b>Service Code Setup (for Setup/Entry Operation) – Set/Cancel Call Forward All Destination (No Split)</b> Assign the Call Forward All for any Extension Service Code.	MLT, SLT 0 ~ 9, *, # Maximum of eight digits	790		✓	
11-11-53	<b>Service Code Setup (for Setup/Entry Operation) – Set/Cancel Call Forward Busy Destination (No Split)</b> Assign the Call Forward Busy for any Extension Service Code.	MLT, SLT 0 ~ 9, *, # Maximum of eight digits	791		✓	
11-11-54	<b>Service Code Setup (for Setup/Entry Operation) – Set/Cancel Call Forward No Answer Destination (No Split)</b> Assign the Call Forward No Answer for any Extension Service Code.	MLT, SLT 0 ~ 9, *, # Maximum of eight digits	792		✓	
11-11-55	<b>Service Code Setup (for Setup/Entry Operation) – Call Forward Busy No Answer Destination (No Split)</b> Set/Cancel the call forward busy or no answer destination with no split.	MLT, SLT 0 ~ 9, *, # Maximum of eight digits	793		✓	
11-11-57	<b>Service Code Setup (for Setup/Entry Operation) – Set Do Not Call Table</b> Customize the set do not call table used for registration and setup.	MLT, SLT 0 ~ 9, *, # Maximum of eight digits	No Setting		✓	
11-11-58	<b>Service Code Setup (for Setup/Entry Operation) – Call Forward with Personal Greeting</b> Set the service code for setting call forwarding with Personal Greeting.	MLT, SLT 0 ~ 9, *, # Maximum of eight digits	713		✓	



Program Number	Program Name/Description	Input Data	Default	Level		
				1	2	3
11-12-01	<b>Service Code Setup (for Service Access) – Bypass Call</b> Set the service code for Activating Call Forwarding/Do Not Disturb Override. This code is available only if you disable the voice mail Single Digit dialing code in Program 11-16-09.	MLT, SLT 0 ~ 9, *, # Maximum of eight digits	707		✓	
11-12-02	<b>Service Code Setup (for Service Access) – Conference</b> Customize the conference Service Codes used for service access.	MLT, SLT 0 ~ 9, *, # Maximum of eight digits	#1		✓	
11-12-03	<b>Service Code Setup (for Service Access) – Override (Off-Hook Signaling)</b> Customize the override (off-hook signaling) used for service access.	MLT, SLT 0 ~ 9, *, # Maximum of eight digits	709		✓	
11-12-04	<b>Service Code Setup (for Service Access) – Set Camp-On</b> Customize the Service Code, used for setting Camp-On.	MLT, SLT 0 ~ 9, *, # Maximum of eight digits	750		✓	
11-12-05	<b>Service Code Setup (for Service Access) – Cancel Camp-On</b> Customize the Service Code, used for cancelling Camp-On.	MLT, SLT 0 ~ 9, *, # Maximum of eight digits	770		✓	
11-12-06	<b>Service Code Setup (for Service Access) – Switching of Voice Call and Signal Call</b> Customize the switching of voice call and signal call used for service access.	MLT, SLT 0 ~ 9, *, # Maximum of eight digits	712		✓	
11-12-07	<b>Service Code Setup (for Service Access) – Step Call</b> Customize the step call used for service access.	MLT, SLT 0 ~ 9, *, # Maximum of eight digits	708		✓	
11-12-08	<b>Service Code Setup (for Service Access) – Barge-In</b> Determine what the service code should be for an internal party to use the Barge-In feature.	MLT, SLT 0 ~ 9, *, # Maximum of eight digits	710		✓	
11-12-09	<b>Service Code Setup (for Service Access) – Change to STG (Department Group) All Ring</b> Set the service code for ringing all members of a Department Group.	MLT, SLT 0 ~ 9, *, # Maximum of eight digits	No Setting		✓	
11-12-10	<b>Service Code Setup (for Service Access) – Station Speed Dialing</b> Assign Service code for accessing System Speed Dial bins.	MLT, SLT 0 ~ 9, *, # Maximum of eight digits	#2		✓	
11-12-11	<b>Service Code Setup (for Service Access) – Group Speed Dialing</b> Customize the group speed dialing Service Codes used for service access.	MLT, SLT 0 ~ 9, *, # Maximum of eight digits	#4		✓	

Program Number	Program Name/Description	Input Data	Default	Level		
				1	2	3
11-12-12	<b>Service Code Setup (for Service Access) – Last Number Dial</b> Assign a service code to use Last Number Dial.	MLT, SLT 0 ~ 9, *, # Maximum of eight digits	#5		✓	
11-12-13	<b>Service Code Setup (for Service Access) – Saved Number Dial</b> Customize the service code used for dialing a saved number.	MLT, SLT 0 ~ 9, *, # Maximum of eight digits	715		✓	
11-12-14	<b>Service Code Setup (for Service Access) – Trunk Group Access</b> Customize the Service Codes used for service access.	MLT, SLT 0 ~ 9, *, # Maximum of eight digits	704		✓	
11-12-15	<b>Service Code Setup (for Service Access) – Specified Trunk Access</b> Customize the Service Codes used for specified trunk access.	MLT, SLT 0 ~ 9, *, # Maximum of eight digits	#9		✓	
11-12-16	<b>Service Code Setup (for Service Access) – Trunk Access Via Networking</b> Customize the Service Codes used for trunk access via networking.	MLT, SLT 0 ~ 9, *, # Maximum of eight digits	No Setting		✓	
11-12-17	<b>Service Code Setup (for Service Access) – Clear Last Number Dialing Data</b> Assign a service code to clear the Last Number Dial.	MLT, SLT 0 ~ 9, *, # Maximum of eight digits	776		✓	
11-12-18	<b>Service Code Setup (for Service Access) – Clear Saved Number Dialing Data</b> Define the service code for Clear Save Number Dialing List if it is not acceptable.	MLT, SLT 0 ~ 9, *, # Maximum of eight digits	785		✓	
11-12-19	<b>Service Code Setup (for Service Access) – Internal Group Paging</b> Define the service code for accessing an internal paging group.	MLT, SLT 0 ~ 9, *, # Maximum of eight digits	701		✓	
11-12-20	<b>Service Code Setup (for Service Access) – External Paging</b> External paging access code. Service code setup.	MLT, SLT 0 ~ 9, *, # Maximum of eight digits	703		✓	
11-12-21	<b>Service Code Setup (for Service Access) – Meet-Me Answer to Specified Internal Paging Group</b> Customize the Service Codes used for meet-me answer to specified internal paging group service access.	MLT, SLT 0 ~ 9, *, # Maximum of eight digits	764		✓	
11-12-22	<b>Service Code Setup (for Service Access) – Meet-Me Answer to External Paging</b> Customize the Service Codes used for meet-me answer to external paging service access.	MLT, SLT 0 ~ 9, *, # Maximum of eight digits	765		✓	

Program Number	Program Name/Description	Input Data	Default	Level		
				1	2	3
11-12-23	<b>Service Code Setup (for Service Access) – Meet-Me Answer in Same Paging Group</b> Customize the Service Codes used for meet-me answer in same paging group service access.	MLT, SLT 0 ~ 9, *, # Maximum of eight digits	763		✓	
11-12-24	<b>Service Code Setup (for Service Access) – Combined Paging</b> Combined paging, internal/external access code. Service code setup.	MLT, SLT 0 ~ 9, *, # Maximum of eight digits	*1		✓	
11-12-25	<b>Service Code Setup (for Service Access) – Direct Call Pickup - Own Group</b> Customize the Service Codes for direct call pickup – own group which are used for service access.	MLT, SLT 0 ~ 9, *, # Maximum of eight digits	756		✓	
11-12-26	<b>Service Code Setup (for Service Access) – Call Pickup for Specified Group</b> Customize the Service Codes for call pickup for specified group which are used for service access.	MLT, SLT 0 ~ 9, *, # Maximum of eight digits	768		✓	
11-12-27	<b>Service Code Setup (for Service Access) – Call Pickup</b> Customize the Service Codes for call pickup which are used for service access.	MLT, SLT 0 ~ 9, *, # Maximum of eight digits	*#		✓	
11-12-28	<b>Service Code Setup (for Service Access) – Call Pickup for Another Group</b> Customize the Service Codes for call pickup for another group which are used for service access.	MLT, SLT 0 ~ 9, *, # Maximum of eight digits	769		✓	
11-12-29	<b>Service Code Setup (for Service Access) – Direct Extension Call Pickup</b> Customize the Service Codes for direct extension call pickup which are used for service access.	MLT, SLT 0 ~ 9, *, # Maximum of eight digits	**		✓	
11-12-30	<b>Service Code Setup (for Service Access) – Specified Trunk Answer</b> If required, redefine the service code used to answer a specific trunk which is either ringing or on hold.	MLT, SLT 0 ~ 9, *, # Maximum of eight digits	672		✓	
11-12-31	<b>Service Code Setup (for Service Access) – Park Hold</b> Set the service code which should be used for placing a call in Park.	MLT, SLT 0 ~ 9, *, # Maximum of eight digits	#6		✓	
11-12-32	<b>Service Code Setup (for Service Access) – Answer for Park Hold</b> Set the service code which should be used for answering a call in Park.	MLT, SLT 0 ~ 9, *, # Maximum of eight digits	*6		✓	

Program Number	Program Name/Description	Input Data	Default	Level		
				1	2	3
11-12-33	<b>Service Code Setup (for Service Access) – Group Hold</b> If required, redefine the service code used to answer a specific trunk which is either ringing or on hold.	MLT, SLT 0 ~ 9, *, # Maximum of eight digits	732		✓	
11-12-34	<b>Service Code Setup (for Service Access) – Answer for Group Hold</b> If required, redefine the service code used to answer a specific trunk which is either ringing or on hold.	MLT, SLT 0 ~ 9, *, # Maximum of eight digits	762		✓	
11-12-35	<b>Service Code Setup (for Service Access) – Station Park Hold</b> Set the service code used for placing a call in a Personal Park.	MLT, SLT 0 ~ 9, *, # Maximum of eight digits	757		✓	
11-12-36	<b>Service Code Setup (for Service Access) – Door Box Access</b> If the service code for Doorphone Access is not acceptable, change it here.	MLT, SLT 0 ~ 9, *, # Maximum of eight digits	702		✓	
11-12-37	<b>Service Code Setup (for Service Access) – Common Canceling Service Code</b> Customize the Service Codes used for common canceling service code access.	MLT, SLT 0 ~ 9, *, # Maximum of eight digits	620		✓	
11-12-38	<b>Service Code Setup (for Service Access) – General Purpose Indication</b> Customize the Service Codes used for general purpose indication access.	MLT 0 ~ 9, *, # Maximum of eight digits	783		✓	
11-12-40	<b>Service Code Setup (for Service Access) – Station Speed Dialing</b> Customize the station speed access Service Codes.	MLT 0 ~ 9, *, # Maximum of eight digits	#7		✓	
11-12-41	<b>Service Code Setup (for Service Access) – Voice Over</b> The service code used for the Voice Over feature.	MLT 0 ~ 9, *, # Maximum of eight digits	690		✓	
11-12-42	<b>Service Code Setup (for Service Access) – Flash on Trunk lines</b> Customize the Service Codes used for flash on trunk lines.	SLT 0 ~ 9, *, # Maximum of eight digits	#3		✓	
11-12-43	<b>Service Code Setup (for Service Access) – Answer No-Ring Line (Universal Answer)</b> Customize the service code used to manually answer a Universal Night Answer.	MLT, SLT 0 ~ 9, *, # Maximum of eight digits	#0		✓	
11-12-44	<b>Service Code Setup (for Service Access) – Callback Test for SLT</b> If required, redefine the service code used for single line telephone Callback Test.	SLT 0 ~ 9, *, # Maximum of eight digits	799		✓	

Program Number	Program Name/Description	Input Data	Default	Level		
				1	2	3
11-12-45	<b>Service Code Setup (for Service Access) – Enabled On Hook When Holding (SLT)</b> Customize the Service Codes used for the enabled on hook when holding (single line telephone).	SLT 0 ~ 9, *, # Maximum of eight digits	749		✓	
11-12-46	<b>Service Code Setup (for Service Access) – Answer On Hook When Holding (SLT)</b> Customize the Service Codes used for the answer on hook when holding (single line telephone).	SLT 0 ~ 9, *, # Maximum of eight digits	759		✓	
11-12-47	<b>Service Code Setup (for Service Access) – Call Waiting Answer/Split Answer</b> If required, use this program to change the code users dial to Split while on a call.	SLT 0 ~ 9, *, # Maximum of eight digits	794		✓	
11-12-48	<b>Service Code Setup (for Service Access) – Account Code</b> Use to customize the Service Codes used for the account code.	SLT 0 ~ 9, *, # Maximum of eight digits	##		✓	
11-12-50	<b>Service Code Setup (for Service Access) – General Purpose Relay</b> Define the service code used for turning the general purpose relay on and off.	MLT, SLT 0 ~ 9, *, # Maximum of eight digits	780		✓	
11-12-51	<b>Service Code Setup (for Service Access) – VM Access (SV9100 InMail and VMS)</b> Customize the Service Codes used for the VM access (InMail and VMS).	MLT, SLT 0 ~ 9, *, # Maximum of eight digits	*8		✓	
11-12-52	<b>Service Code Setup (for Service Access) – Live Monitoring (SV9100 InMail)</b> Define access code used for InMail Live Monitoring (VRS). At default this program is not set.	MLT 0 ~ 9, *, # Maximum of eight digits	No Setting		✓	
11-12-53	<b>Service Code Setup (for Service Access) – Live Recording at SLT</b> Customize the Service Codes used for live recording at single live telephone.	MLT, SLT 0 ~ 9, *, # Maximum of eight digits	654		✓	
11-12-54	<b>Service Code Setup (for Service Access) – VRS Routing for ANI/DNIS</b> Define the service code to use when setting up ANI/DNIS Routing to the VRS Automated Attendant. Using the Transfer feature, this also allows a call to be transferred to the VRS.	MLT, SLT 0 ~ 9, *, # Maximum of eight digits	782		✓	
11-12-56	<b>Service Code Setup (for Service Access) – E911 Alarm Shut Off</b> Select the Service Code that an extension user can dial to shut off the E911 Alarm Ring.	MLT, SLT 0 ~ 9, *, # Maximum of eight digits	786		✓	

Program Number	Program Name/Description	Input Data	Default	Level		
				1	2	3
11-12-57	<b>Service Code Setup (for Service Access) – Tandem Trunking</b> With two trunks in Conference press the Hold key and dial #8 and the Conference/Tandem happens.	MLT, SLT 0 ~ 9, *, # Maximum of eight digits	#8		✓	
11-12-58	<b>Service Code Setup (for Service Access) – Transfer Into Conference</b> If required, change the service code used to transfer a call into a Conference call.	MLT, SLT 0 ~ 9, *, # Maximum of eight digits	624		✓	
11-12-59	<b>Service Code Setup (for Service Access) – Trunk Drop Operation for SLT</b> Customize the trunk drop operation for SLT Service Codes which are used for service access.	SLT 0 ~ 9, *, # Maximum of eight digits	No Setting		✓	
11-13-01	<b>Service Code Setup (for) – LogIn/Log Out (for KTS)</b> Assign for multiline terminals and single line telephones.	MLT, SLT 0 ~ 9, *, # Maximum of eight digits	* 5		✓	
11-13-02	<b>Service Code Setup (for) – Log Out (for SLT)</b> Assign for single line telephones.	SLT 0 ~ 9, *, # Maximum of eight digits	655		✓	
11-13-03	<b>Service Code Setup (for) – Set Wrap-Up Time (for SLT)</b> Assign for single line telephones.	SLT 0 ~ 9, *, # Maximum of eight digits	656		✓	
11-13-04	<b>Service Code Setup (for) – Cancel</b> Assign for single line telephones.	SLT 0 ~ 9, *, # Maximum of eight digits	657		✓	
11-13-05	<b>Service Code Setup (for) – Set Off Duty (for SLT)</b> Assign for single line telephones.	SLT 0 ~ 9, *, # Maximum of eight digits	658		✓	
11-13-06	<b>Service Code Setup (for) – Cancel Off Duty (for SLT)</b> Assign for single line telephones.	SLT 0 ~ 9, *, # Maximum of eight digits	659		✓	
11-13-08	<b>Service Code Setup (for) – Agent ID Code Login</b> Assign to allow an AIC Agent to log into a group.	MLT 0 ~ 9, *, # Maximum of eight digits	No Setting		✓	
11-13-09	<b>Service Code Setup (for) – Agent ID Code Logout</b> Assign to allow an AIC Agent to log out of a group.	MLT 0 ~ 9, *, # Maximum of eight digits	No Setting		✓	
11-13-10	<b>Service Code Setup (for) – Agent Login by Supervisor</b> Assign to allow a Supervisor to log into a group.	MLT 0 ~ 9, *, # Maximum of eight digits	667		✓	

Program Number	Program Name/Description	Input Data	Default	Level		
				1	2	3
11-13-11	<b>Service Code Setup (for) – Agent Logout by Supervisor</b> Assign to allow a Supervisor to log out of a group.	MLT 0 ~ 9, *, # Maximum of eight digits	668		✓	
11-13-12	<b>Service Code Setup (for) – Change Agent Group by Supervisor</b> When using service code 669 to change an agent group, the supervisor must enter a 2-digit number for the group. For example, to change to group 4, the entry would be 669 04.	MLT 0 ~ 9, *, # Maximum of eight digits	669		✓	
11-13-13	<b>Service Code Setup (for) – Agent Changing Own Group</b> When this service code is used, an Agent can reassign themselves to another Group.	MLT 0 ~ 9, *, # Maximum of eight digits	670		✓	
11-14-01	<b>Service Code Setup (for Hotel) – Set DND for Own Extension</b> Customize the set DND for own extension used with the Hotel/Motel feature.	MLT, SLT 0 ~ 9, *, # Maximum of eight digits	627		✓	
11-14-02	<b>Service Code Setup (for Hotel) – Cancel DND for Own Extension</b> Customize the cancel DND for own extension used with the Hotel/Motel feature.	MLT, SLT 0 ~ 9, *, # Maximum of eight digits	628		✓	
11-14-03	<b>Service Code Setup (for Hotel) – Set DND for Other Extension</b> Customize the set DND for other extension used with the Hotel/Motel feature.	MLT, SLT 0 ~ 9, *, # Maximum of eight digits	629		✓	
11-14-04	<b>Service Code Setup (for Hotel) – Cancel DND for Other Extension</b> Customize the cancel DND for other extension used with the Hotel/Motel feature.	MLT, SLT 0 ~ 9, *, # Maximum of eight digits	630		✓	
11-14-05	<b>Service Code Setup (for Hotel) –Set Wake Up Call for Own Extension</b> Customize the set wake up call for own extension used with the Hotel/Motel feature.	MLT, SLT 0 ~ 9, *, # Maximum of eight digits	631		✓	
11-14-06	<b>Service Code Setup (for Hotel) – Cancel Wake Up Call for Own Extension</b> Customize the cancel wake up call for own extension used with the Hotel/Motel feature.	MLT, SLT 0 ~ 9, *, # Maximum of eight digits	632		✓	
11-14-07	<b>Service Code Setup (for Hotel) – Set Wake Up Call for Other Extension</b> Customize the set wake up call for other extension used with the Hotel/Motel feature.	MLT, SLT 0 ~ 9, *, # Maximum of eight digits	633		✓	
11-14-08	<b>Service Code Setup (for Hotel) – Cancel Wake Up Call for Other Extension</b> Customize the cancel wake up call for other extension used with the Hotel/Motel feature.	MLT, SLT 0 ~ 9, *, # Maximum of eight digits	634		✓	

Program Number	Program Name/Description	Input Data	Default	Level		
				1	2	3
11-14-09	<b>Service Code Setup (for Hotel) – Set Room to Room Call Restriction</b> Customize the set room to room call extension used with the Hotel/Motel feature.	MLT, SLT 0 ~ 9, *, # Maximum of eight digits	635		✓	
11-14-10	<b>Service Code Setup (for Hotel) –Cancel Room to Room Call Restriction (Hotel)</b> Customize the cancel room to room call restriction (hotel) used with the Hotel/Motel feature.	MLT, SLT 0 ~ 9, *, # Maximum of eight digits	636		✓	
11-14-11	<b>Service Code Setup (for Hotel) – Change Toll Restriction Class for Other Extension</b> Customize the change toll restriction class for other extension used with the Hotel/Motel feature.	MLT, SLT 0 ~ 9, *, # Maximum of eight digits	637		✓	
11-14-12	<b>Service Code Setup (for Hotel) – Check-In</b> Customize the check-in Service Codes used with the Hotel/Motel feature.	MLT, SLT 0 ~ 9, *, # Maximum of eight digits	638		✓	
11-14-13	<b>Service Code Setup (for Hotel) – Check-Out</b> Customize the check-out Service Codes used with the Hotel/Motel feature.	MLT, SLT 0 ~ 9, *, # Maximum of eight digits	639		✓	
11-14-14	<b>Service Code Setup (for Hotel) – Room Status Change for Own Extension</b> Customize the room status change for own extension Service Codes used with the Hotel/Motel feature.	MLT, SLT 0 ~ 9, *, # Maximum of eight digits	640		✓	
11-14-15	<b>Service Code Setup (for Hotel) – Room Status Change for Other Extension</b> Customize the room status change for other extension Service Codes used with the Hotel/Motel feature.	MLT, SLT 0 ~ 9, *, # Maximum of eight digits	641		✓	
11-14-16	<b>Service Code Setup (for Hotel) – Room Status Output</b> Customize the room status output Service Codes used with the Hotel/Motel feature.	MLT 0 ~ 9, *, # Maximum of eight digits	642		✓	
11-14-17	<b>Service Code Setup (for Hotel) – Hotel Room Monitor</b> Customize the hotel room monitor Service Codes used with the Hotel/Motel feature.	MLT, SLT 0 ~ 9, *, # Maximum of eight digits	675		✓	
11-14-18	<b>Service Code Setup (for Hotel) – Set Hotel PMS Code Restriction</b> Customize the set hotel PMS code restriction Service Codes used with the Hotel/Motel feature.	MLT 0 ~ 9, *, # Maximum of eight digits	666		✓	
11-15-01	<b>Service Code Setup, Administrative (for Special Access) – Remote Maintenance</b> Customize the remote maintenance Service Codes used by the administrator in the Hotel/Motel feature.		730		✓	



Program Number	Program Name/Description	Input Data	Default	Level		
				1	2	3
11-15-02	<p><b>Service Code Setup, Administrative (for Special Access) – Access in Dial-In Conversion Table</b></p> <p>Customize the access in dial-in conversion table Service Codes used by the administrator in the Hotel/Motel feature.</p>		760		✓	
11-15-03	<p><b>Service Code Setup, Administrative (for Special Access) – Backup Data Save</b></p> <p>This service code is used to back up the programmed data on the SRAM and Call History to the Flash ROM. While saving the database, it may cause system lock up.</p>	MLT 0 ~ 9, *, # Maximum of eight digits	##9		✓	
11-15-05	<p><b>Service Code Setup, Administrative (for Special Access) – System Programming Mode, Log-On</b></p> <p>Customize the system programming mode, log-on Service Codes used by the administrator in the Hotel/Motel feature.</p>	MLT 0 ~ 9, *, # Maximum of eight digits	###		✓	
11-15-06	<p><b>Service Code Setup, Administrative (for Special Access) – Wake on LAN to APSU Unit</b></p> <p>Customize the wake on LAN to APSU unit Service Codes.</p>	MLT 0 ~ 9, *, # Maximum of eight digits	No Setting		✓	
11-15-09	<p><b>Service Code Setup, Administrative (for Special Access) – Transfer to Incoming Ring Group</b></p> <p>When a call is transferred using this service code, it is transferred to the ring group destination for that incoming trunk. For example, trunk 2 is in Ring Group 4. When the call is transferred using this service code, the trunk rings all extensions programmed for Ring Group 4 or ring the External Paging Group for Ring Group 4, depending on how the system is programmed.</p>		No Setting		✓	
11-15-11	<p><b>Service Code Setup, Administrative (for Special Access) – Ethernet Port Reset</b></p> <p>Customize the Ethernet port reset Service Codes.</p>		No Setting		✓	
11-15-12	<p><b>Service Code Setup, Administrative (for Special Access) – Extension Data Swap</b></p> <p>Ext. Data Swap = xxx (service code in accordance with Program 11-01).</p>	MLT 0 ~ 9, *, # Maximum of eight digits	No Setting		✓	
11-15-13	<p><b>Service Code Setup, Administrative (for Special Access) – Remote Access from DISA</b></p> <p>Customize the service code for Remote Access for DISA.</p>	SLT	No Setting		✓	

Program Number	Program Name/Description	Input Data	Default	Level		
				1	2	3
11-15-14	<b>Service Code Setup, Administrative (for Special Access) – Modem Access</b> Assign the service code used to access the internal modem on the GCD-CP10.		740		✓	
11-16-01	<b>Single Digit Service Code Setup – Step Call</b> Assign the Single Digit (post-dialing) Service Codes.	0 ~ 9, *, # Maximum of one digit	2		✓	
11-16-02	<b>Single Digit Service Code Setup – Barge-In</b> Set up Item 02 for single digit Barge-In. For example, you can assign Item 02 to use digit 5 for Barge-In. This would allow you to program a function key with an extension number plus the Barge-In code (i.e., 5). This allows one-touch access to the Barge-In feature for extension.	0 ~ 9, *, # Maximum of one digit	No Setting		✓	
11-16-03	<b>Single Digit Service Code Setup – Switching of Voice/Signal Call</b> Customize the switching of Voice/Signal call Service Codes used when a busy or ring back signal is heard.	0 ~ 9, *, # Maximum of one digit	1		✓	
11-16-04	<b>Single Digit Service Code Setup – Intercom Off-Hook Signaling</b> Assign a one-digit service code to be used for off-hook Signaling.	0 ~ 9, *, # Maximum of one digit	*		✓	
11-16-05	<b>Single Digit Service Code Setup – Camp-On</b> Customize the 1-digit Service Code used for setting Camp-On.	0 ~ 9, *, # Maximum of one digit	#		✓	
11-16-06	<b>Single Digit Service Code Setup – DND/Call Forward Override Bypass</b> Customize the 1-digit Service Code used for DND/Call Forward Override.	0 ~ 9, *, # Maximum of one digit	No Setting		✓	
11-16-07	<b>Single Digit Service Code Setup – Message Waiting</b> Customize the message waiting Service Codes used when a busy or ring back signal is heard.	0 ~ 9, *, # Maximum of one digit	0		✓	
11-16-08	<b>Single Digit Service Code Setup – Voice Over</b> Service code used for the Voice Over feature.	0 ~ 9, *, # Maximum of one digit	6		✓	
11-16-09	<b>Single Digit Service Code Setup – Access to Voice Mail</b> Customize the access to voice mail Service Codes used when a busy or ring back signal is heard.	0 ~ 9, *, # Maximum of one digit	8		✓	
11-16-10	<b>Single Digit Service Code Setup – (Department) STG All Ring Mode</b> Assign the Single Digit (post-dialing) Service Code for All Member Ring.	0 ~ 9, *, # Maximum of one digit	No Setting		✓	

Program Number	Program Name/Description	Input Data	Default	Level		
				1	2	3
11-16-11	<b>Single Digit Service Code Setup – Station Park Hold</b> Customize the one-digit service code used when placing a call in Personal Park.	0 ~ 9, *, # Maximum of one digit	No Setting		✓	
11-20-01	<b>Dial Extension Analyze Table – Dial Digits</b> Use tables 01 ~ 128 to assign the digits to be dialed using the Dial Extension Analyze Tables. These tables are used when Program 11-01-01 is set to option 9 = Dial Extension Analyze. Up to eight digits can be assigned.	Dial maximum of eight digits (0 ~ 9, #, *, @)	No Setting	✓		
11-20-02	<b>Dial Extension Analyze Table – Type of Dials</b> Assign the Type of Dial for the Extension Analyze Table from Program 11-20-01.	Type of Dials: 0 = Not used 1 = Service Code 2 = Extension Number 5 = Operator Access 6 = F-Route Access	No Setting	✓		

## Operation

None

## Flexible Timeouts

### Description

The Flexible Timeouts feature provides a variety of timers in the Resident System Program to allow the system to operate without initial programming. The system timers can be changed to meet customer needs according to the system application requirements.

A Timer Class is used to allow terminals and trunks to have different timers for the same feature. There are 16 timer Classes (0~15). The following table shows the Programs that are used depending on the Timer Class used:

Timer Class 0	Timer Class 1~15	Title	Comment
20-01-08	20-31-01	Trunk Queuing Callback Time	Trunk Queuing callback rings an extension for this time. Station Timer Class is referred by the station that sets trunk queuing.
20-01-09	20-31-02	Callback / Trunk Queuing Cancel Time	The system cancels an extension Callback or Trunk Queuing request after this time. Station Timer Class is referred by the station that sets an extension Callback or Trunk Queuing.
20-04-03	20-31-03	CAR/SIE/Virtual Extension Delay Interval	If CAR/VE is set for Delayed Ringing (Program 15-11-01), ring the covering extension after this time. Station Timer Class is referred by the station assigned to CAR/VE.
21-01-02	20-31-04	Intercom Interdigits Time	When placing Intercom calls, users must dial each digit in this time. Station Timer Class is referred by stations. Trunk Timer Class is referred by DID/ Automatic Answer Trunk/E&M trunks.
21-01-03	20-31-05	Trunk Interdigits Time	When placing CO calls, users must dial each digit in this time. Station Timer Class is referred by stations. Trunk Timer Class is referred by DID/Automatic Answer Trunk/E&M trunks.
21-01-09	20-31-06	Hotline Time Start Time	A Ringdown extension automatically calls its programmed destination after this time. Station Timer Class is referred by the stations which sets Hotline.
22-01-03	20-31-07	Ring No Answer Alarm Time	If a trunk rings a key telephone longer than this time, the system changes the ring cadence. This indicates to the user that the call was ringing too long. Trunk Timer Class is referred by the trunk.
22-01-04	20-31-08	DIL No Answer Recall Time	A DIL that rings its programmed destination longer than this time diverts to the DIL No Answer Ring Group (Program 22-08-01). Trunk Timer Class is referred by the trunk.

Timer Class 0	Timer Class 1~15	Title	Comment
22-01-06	20-31-09	DID Ring-No-Answer Time	In systems with DID Ring No Answer Intercept, this time sets the Ring No Answer time. This time is how long a DID call rings the destination extension before rerouting to the intercept ring group. Trunk Timer Class is referred by DID trunk.
24-01-01	20-31-10	Hold Recall Time (Non Exclusive Hold)	A call on Hold recalls the extension that placed it on Hold after this time. Station Timer Class is referred by held call.
24-01-02	20-31-11	Hold Recall Callback Time (Non Exclusive Hold)	A Hold recall rings an extension for this time. Station Timer Class is referred by held call.
24-01-03	20-31-12	Exclusive Hold Recall Time	A call on Hold recalls the extension that placed it on Hold after this time. Station Timer Class is referred by held call.
24-01-04	20-31-13	Exclusive Hold Recall Callback Time	An Exclusive Hold Recall rings an extension for this time. If not picked up, the call goes back on Non exclusive Hold. Station Timer Class is referred by held call.
24-01-06	20-31-14	Park Hold Time – Normal	A call left parked longer than this time recalls the extension that initially parked it. Trunk or Station Timer Class is referred by held call.
24-02-03	20-31-15	Delayed Call Forwarding Time	If activated at an extension, No Answer Call Forwarding occurs after this time. Station Timer Class is referred by the station sets No Answer Call Forward.
24-02-04	20-31-16	Transfer Recall Time	A transferred call recalls to the extension that initially transferred it after this time. Station Timer Class is referred by transferred call.
25-07-02	20-31-17	VRS/DISA No Answer Time	After this time expires, the call follows the programmed Ring No Answer routing (Program 25-03 and 25-04-01). Trunk Timer Class is referred.
25-07-03	20-31-18	Disconnect after VRS/DISA Re-transfer to IRG	Disconnect after re-transfer to Incoming Ring Group. Trunk Timer Class is referred.
25-07-07	20-31-19	Long Conversation Warning Tone Time	Determine the time trunk-to-trunk conversation can talk before the Long Conversation tone is heard. Trunk Timer Class is referred.
25-07-08	20-31-20	Long Conversation Disconnect Time	This timer determines how long the system waits before disconnecting a trunk-to-trunk conversation call after the Long Conversation tone is heard. Trunk Timer Class is referred.
25-07-09	20-31-21	DISA Internal Paging Time	This is the maximum length of an Internal Page placed by a DISA caller. If the Page continues longer than this time, the system terminates the DISA call. Trunk Timer Class is referred.

Timer Class 0	Timer Class 1~15	Title	Comment
25-07-10	20-31-22	DISA External Paging Time	This is the maximum length of an External Page placed by a DISA caller. If the Page continues longer than this time, the system terminates the DISA call. Trunk Timer Class is referred.
31-01-02	20-31-23	Page Announcement Duration	This timer sets the maximum length of External Page announcements. Station or Trunk Timer Class is referred by the caller makes announcement.

### Conditions

- Timer Classes are also used for CAR/VE.
- When Timer Class is set to 0 it uses the system-wide timers.
- All stations and trunks are assigned to Timer Class 0 at default.
- Both system-wide timers (Timer Class 0) and Timer Class timers (Timer Class 1~15) can be used in the same system.

### Default Settings

Timer Class set to 0 for all trunks and extensions.

## System Availability

### Terminals

All Multiline Terminals

### Required Component(s)

None

## Related Features

None

## Guide to Feature Programming

The **Level 1**, **Level 2** and **Level 3** columns indicate the programs that are assigned when programming this feature in the order they are most commonly used. These levels are used with PCPro and WebPro wizards for feature programming.

- Level 1 – these are the most commonly assigned programs for this feature.
- Level 2 – these are the next most commonly assigned programs for this feature.
- Level 3 – these programs are not often assigned and require an expert level working knowledge of the system to be properly assigned.

Program Number	Program Name/Description	Input Data	Default	Level		
				1	2	3
20-01-08	<b>System Options – Trunk Queuing Callback Time</b> Set the Trunk Queuing callback time. A Trunk Queuing Callback rings an extension for this interval.	0 ~ 64800 seconds	15		✓	
20-01-09	<b>System Options – Callback/Trunk Queuing Cancel Time</b> The system cancels an extension Callback or Trunk Queuing request after this interval.	0 ~ 64800 seconds	64800		✓	
20-04-03	<b>System Options for Virtual Extensions – CAR/SIE/Virtual Extension Delay Interval</b> CAR Keys/SIE Keys/Virtual Extensions set for Delayed Ringing (see Program 15-11) ring the extension after this interval.	0 ~ 64800 seconds	10		✓	
20-29-01	<b>Timer Class for Extensions</b> Assign the timer class (0 ~ 15) to each extension for each Night mode. This entry includes virtual extension number.	0 ~ 15 0 = Not assigned	0		✓	
20-30-01	<b>Timer Class for Trunks</b> Assign the timer class (0 ~ 15) to each trunk for each Night mode.	0 ~ 15, #, * 0 = Not assigned	0		✓	
20-31-01	<b>Timer Class Timer Assignment – Trunk Queuing Callback Duration Time</b> Trunk Queuing Callback rings an extension for this time.	0 ~ 64800 seconds	15		✓	
20-31-02	<b>Timer Class Timer Assignment – Callback / Trunk Queuing Cancel Time</b> The system cancels an extension Callback or Trunk Queuing request after this time.	0 ~ 64800 seconds	648000		✓	
20-31-03	<b>Timer Class Timer Assignment – CAR/SIE/ Virtual Extension Delay Interval</b> CAR Keys/SIE Keys/Virtual Extensions set for Delayed Ringing (refer to <a href="#">15-11: Virtual Extension Delayed Ring Assignment</a> ) ring the extension after this time.	0 ~ 64800 seconds	10		✓	

Program Number	Program Name/Description	Input Data	Default	Level		
				1	2	3
20-31-04	<b>Timer Class Timer Assignment – Intercom Interdigits Time (Intercom I/D Timer)</b> When placing Intercom calls, extension users must dial each digit during this time.	0 ~ 64800 seconds	10		✓	
20-31-05	<b>Timer Class Timer Assignment – Trunk Interdigits Time (Trunk I/D Timer)</b> The system waits for this time to expire before placing the call in a talk state (Call Timer starts after time expires, Voice Over and Barge-In are not allowed until after time expires).	0 ~ 64800 seconds	5		✓	
20-31-06	<b>Timer Class Timer Assignment – Hotline Time Start Time (Hotline Start)</b> A Ringdown extension automatically calls its programmed destination after this time.	0 ~ 64800 seconds	5		✓	
20-31-07	<b>Timer Class Timer Assignment – Ring No Answer Alarm Time</b> If a trunk rings a multiline telephone longer than this time, the system changes the ring cadence. This indicates to the user that the call has been ringing too long.	0 ~ 64800 seconds	60		✓	
20-31-08	<b>Timer Class Timer Assignment – DIL/ Incoming Ring Group No Answer Time</b> A DIL that rings its programmed destination longer than this time diverts to the DIL No Answer Ring Group (set in Program 22-08).	0 ~ 64800 seconds	0		✓	
20-31-09	<b>Timer Class Timer Assignment – DID Ring-No-Answer Time</b> In systems with DID Ring-No-Answer Intercept, this time sets the Ring-No-Answer time. This is the time a DID call rings the destination extension before rerouting to the intercept ring group.	0 ~ 64800 seconds	20		✓	
20-31-10	<b>Timer Class Timer Assignment – Hold Recall Time (Non Exclusive Hold)</b> A call on Hold recalls the extension that placed it on Hold after this time. This time works with the Hold Recall Callback Time (Program 24-01-02).	0 ~ 64800 seconds	90		✓	
20-31-11	<b>Timer Class Timer Assignment – Hold Recall CallBack Time (Non Exclusive Hold)</b> A trunk recalling from Hold or Park rings an extension for this time. This time works with Hold Recall Time or Park Hold Time. After this time, the system invokes the Hold Recall Time again. Cycling between time Program 24-01-01 and 24-01-02 and Program 24-01-06 and 24-01-07 continues until a user answers the call.	0 ~ 64800 seconds	30		✓	



Program Number	Program Name/Description	Input Data	Default	Level		
				1	2	3
20-31-12	<b>Timer Class Timer Assignment – Exclusive Hold Recall Time</b> A call on Exclusive Hold recalls the extension that placed it on Hold after this time.	0 ~ 64800 seconds	90		✓	
20-31-13	<b>Timer Class Timer Assignment – Exclusive Hold Recall Callback Time</b> An Exclusive Hold Recall rings an extension for this time. If not picked up, the call goes back on System Hold.	0 ~ 64800 seconds	30		✓	
20-31-14	<b>Timer Class Timer Assignment – Park Hold Time – Normal</b> A call left parked longer than this time, recalls the extension that initially parked it.	0 ~ 64800 seconds	90		✓	
20-31-15	<b>Timer Class Timer Assignment – Delayed Call Forwarding Time (Call Forward No Answer)</b> If activated at an extension, Delayed Call Forwarding occurs after this time. This also sets how long a Transferred call waits at an extension forwarded to Voice Mail before routing to the called extension mailbox.	0 ~ 64800 seconds	10		✓	
20-31-16	<b>Timer Class Timer Assignment – Transfer Recall Time</b> An unanswered transferred call recalls after this time to the extension that initially transferred it.	0 ~ 64800 seconds	30		✓	
20-31-17	<b>Timer Class Timer Assignment – VRS/DISA No Answer Time (Disconnect or IRG or VM)</b> A VRS/DISA caller can ring an extension for this time before the system sets the call as a Ring No Answer. After this time expires, the call follows the programmed Ring No Answer routing (set in Program 25-03 and 25-04).	0 ~ 64800 seconds	00		✓	
20-31-18	<b>Timer Class Timer Assignment – Disconnect after Re-transfer to IRG</b> Assign Disconnect after Re-transfer to IRG time.	0 ~ 64800 seconds	60		✓	
20-31-19	<b>Timer Class Timer Assignment – Long Conversation Warning Tone Time (Trunk to Trunk)</b> Determine the time a DISA caller or any trunk-to-trunk (such as Tandem Trunking) conversation can last before the Long Conversation tone is heard.	0 ~ 64800 seconds	3600		✓	
20-31-20	<b>Timer Class Timer Assignment – Long Conversation Disconnect (Trunk to Trunk)</b> Determine the time the system waits before disconnecting a DISA caller or any trunk-to-trunk (such as Tandem Trunking) conversation call after the Long Conversation tone is heard.	0 ~ 64800 seconds	10		✓	

Program Number	Program Name/Description	Input Data	Default	Level		
				1	2	3
20-31-21	<b>Timer Class Timer Assignment – DISA Internal Paging Time</b> Set the maximum time of an Internal Page placed by a DISA caller. If the Page continues longer than this time, the system terminates the DISA call.	0 ~ 64800 seconds	30		✓	
20-31-22	<b>Timer Class Timer Assignment – DISA External Paging Time</b> Set the maximum time of an External Page placed by a DISA caller. If the Page continues longer than this time, the system terminates the DISA call.	0 ~ 64800 seconds	30		✓	
20-31-23	<b>Timer Class Timer Assignment – Page Announcement Duration</b> Set the maximum time for Page announcements. (Affects External Paging only).	0 ~ 64800 seconds	1200		✓	
21-01-02	<b>System Options for Outgoing Calls – Intercom Interdigit Time</b> Set the time-out time for DID callers that do not dial. After this time, the DID call routes according to Vacant Number Intercept programming.	0 ~ 64800 seconds	10		✓	
21-01-03	<b>System Options for Outgoing Calls – Trunk Interdigit Time (External)</b> Program the time an extension user must wait before the Barge-In feature can be used on a call (this time expires before a call is put in a talk state). This time also affects Voice Over.	0 ~ 64800 seconds	5		✓	
21-01-09	<b>System Options for Outgoing Calls – Ringdown Extension Timer (Hotline Start)</b> After the user lifts the handset, the extension automatically calls the ringdown destination after this time. A setting of 0 immediately rings the programmed extension. Any other setting delays the ringdown the time programmed.	0 ~ 64800 seconds	5		✓	
22-01-03	<b>System Options for Incoming Calls – Ring No Answer Alarm Time</b> Set the Ring No Answer Alarm time. If a trunk rings a multiline terminal longer than this time, the system changes the ring cadence.	0 ~ 64800 seconds	60		✓	
22-01-04	<b>System Options for Incoming Calls – DIL No Answer Recall Time</b> A DIL that rings its programmed destination longer than this time, diverts to the DIL No Answer Ring Group (set in Program 22-08).	0 ~ 64800 seconds	0		✓	

Program Number	Program Name/Description	Input Data	Default	Level		
				1	2	3
22-01-06	<p><b>System Options for Incoming Calls – DID Ring-No-Answer Time</b></p> <p>Set the DID Ring No Answer (RNA) Intercept time (0 ~ 64800 seconds). In systems with RNA Intercept, the DID call rings the destination extension for this time, and then rings Intercept Ring Group.</p>	0 ~ 64800 seconds	20		✓	
24-01-01	<p><b>System Options for Hold – Hold Recall Time</b></p> <p>Set the Hold Recall Time. A call on Hold recalls the extension that placed it on Hold after this time.</p>	0 ~ 64800 seconds	90		✓	
24-01-02	<p><b>System Options for Hold – Hold Recall Callback Time</b></p> <p>Set the Hold Recall Callback Time. A trunk recalling from Hold rings an extension for this time.</p>	0 ~ 64800 seconds	30		✓	
24-01-03	<p><b>System Options for Hold – Exclusive Hold Recall Time</b></p> <p>Set the Exclusive Hold Recall Time. A call on Exclusive Hold recalls the extension that placed it on Hold after this time.</p>	0 ~ 64800 seconds	90		✓	
24-01-04	<p><b>System Options for Hold – Exclusive Hold Recall Callback Time</b></p> <p>Set the Hold Recall Time. A trunk recalling from Hold rings an extension for this time. If still unanswered, the call changes to System Hold.</p>	0 ~ 64800 seconds	30		✓	
24-01-06	<p><b>System Options for Hold – Park Hold Time - Normal</b></p> <p>Set the Park Hold Time (0 ~ 64800 seconds). A call that is parked longer than the programmed time recalls the extension where it was initially parked.</p> <p>Refer to <a href="#">Flexible System Numbering on page 2-545</a> for setting Flexible Timeouts for Class of Service.</p>	0 ~ 64800 seconds	90		✓	
24-02-03	<p><b>System Options for Transfer – Delayed Call Forwarding Time</b></p> <p>Set the Delayed Call Forwarding time. For an unanswered call, Call Forward No Answer occurs after this time.</p>	0 ~ 64800 seconds	10		✓	
24-02-04	<p><b>System Options for Transfer – Transfer Recall Time</b></p> <p>Set the Transfer Recall Time. An unanswered transferred call recalls to the extension that initially transferred it after this time. This also sets the time a transferred call camps-on to a busy extension.</p>	0 ~ 64800 seconds	30		✓	

Program Number	Program Name/Description	Input Data	Default	Level		
				1	2	3
25-07-02	<b>System Timers for VRS/DISA – VRS/DISA No Answer Time</b> A VRS/DISA caller can ring an extension for this time before the system sets the call as a Ring No Answer. After this time expires, the call follows the programmed Ring No Answer routing (set in Program 25-03 and Program 25-04).	0 ~ 64800 seconds	0		✓	
25-07-03	<b>System Timers for VRS/DISA – Disconnect after VRS/DISA retransfer to IRG</b> Define the system timers which affect DID and DISA after VRS/DISA retransfer to IRG.	0 ~ 64800 seconds	60		✓	
25-07-07	<b>System Timers for VRS/DISA – Long Conversation Warning Tone Time</b> Determine the time a DISA caller or any trunk-to-trunk (such as Tandem Trunking) conversation can talk before the Long Conversation tone is heard.	0 ~ 64800 seconds	3600		✓	
25-07-08	<b>System Timers for VRS/DISA – Long Conversation Disconnect Time</b> Determine the time the system waits before disconnecting a DISA caller or any trunk-to-trunk (such as Tandem Trunking) conversation call after the Long Conversation tone is heard.	0 ~ 64800 seconds	10		✓	
25-07-09	<b>System Timers for VRS/DISA – DISA Internal Paging Time</b> Set the maximum time for an Internal Page placed by a DISA caller. If the Page continues longer than this time, the system terminates the DISA call.	0 ~ 64800 seconds	30		✓	
25-07-10	<b>System Timers for VRS/DISA – DISA External Paging Time</b> Set the maximum time for an External Page placed by a DISA caller. If the Page continues longer than this time, the system terminates the DISA call.	0 ~ 64800 seconds	30		✓	
31-01-02	<b>System Options for Internal/External Paging – Page Announcement Duration</b> Set the maximum allowable time for a Paging announcement.	0 ~ 64800 seconds	1200		✓	

## Operation

None

## Forced Trunk Disconnect

### Description

Forced Trunk Disconnect allows an extension user to disconnect (release) another extension active outside call. The user can then place a call on the released trunk. Forced Trunk Disconnect lets a user access a busy trunk in an emergency, when no other trunk is available. Maintenance technicians can also use Forced Trunk Disconnect to release a trunk on which there is no conversation. This can happen if a trunk does not properly disconnect when the outside party hangs up.



*Forced Trunk Disconnect abruptly terminates the active call on the line. Only use this feature in an emergency and when no other lines are available.*

### Conditions

This feature only works on an analog trunk. ISDN and IP trunks do not have the Forced Trunk Disconnect available.

### Default Setting

- COS 15 = Enabled
- COS 1~14 = Disabled

### System Availability

#### Terminals

All Terminals

#### Required Component(s)

Analog Trunks

### Related Features

➔ [Central Office Calls, Placing](#)

## Guide to Feature Programming

The **Level 1**, **Level 2** and **Level 3** columns indicate the programs that are assigned when programming this feature in the order they are most commonly used. These levels are used with PCPro and WebPro wizards for feature programming.

- Level 1 – these are the most commonly assigned programs for this feature.
- Level 2 – these are the next most commonly assigned programs for this feature.
- Level 3 – these programs are not often assigned and require an expert level working knowledge of the system to be properly assigned.

Program Number	Program Name/Description	Input Data	Default	Level		
				1	2	3
11-10-26	<b>Service Code Setup (for System Administrator) – Forced Trunk Disconnect</b> Assign the Service Code.	MLT, SLT 0 ~ 9, *, # Maximum of eight digits	No Setting	✓		
20-06-01	<b>Class of Service for Extensions</b> Assign a Class of Service (COS) to an extension. There are 15 Classes of Service that can be assigned. Assign eight entries, one for each Night Service Mode.	Day Night/Mode: 1 ~ 8 Class of Service of Extensions (1 ~ 15)	Extension port 101 = Class 15 All other extension port = Class 1	✓		
20-07-11	<b>Class of Service Options (Administrator Level) – Forced Trunk Disconnect (analog trunk only)</b> Turn Off or On an extension ability to use Forced Trunk Disconnect. This allows the extension to disconnect an Unsupervised Conference in progress.	0 = Off 1 = On	COS 1 ~ 14 = 0 COS 15 = 1	✓		
21-01-18	<b>System Options for Outgoing Calls – Reset Dial After Failure of Trunk Access</b> Enable/Disable an extension user ability to continue to dial codes or extensions after receiving Trunk Busy. This must be Enabled for this feature to work.	0 = Enable (On) 1 = Disable (Off)	1	✓		

## Operation

### To disconnect a busy trunk:

#### Multiline Terminal

1. Press line key for trunk.  
- OR -  
Dial trunk access code (**#9** + trunk number).  
◇ *You hear busy tone. Trunk numbers are 001~400.*
2. Dial the Service Code (not set at default).  
◇ *You hear confirmation beeps as the system disconnects the trunk.*  
◇ *You can now place a call on the free trunk.*
3. Press the line key for the trunk disconnected in Step 2.  
- OR -  
Dial the trunk access code (**#9** + trunk number) for the trunk disconnected in Step 2.

#### Single Line Telephone

1. Dial trunk access code (**#9** + trunk number).  
◇ *You hear busy tone. Trunk numbers are 001~400.*
2. Dial Service Code (not set at default).  
◇ *You hear confirmation beeps as the system disconnects the line.*
3. Hookflash.  
◇ *You can now place a call on the free line.*
4. Dial the trunk access code (**#9** + trunk number) for the trunk disconnected in Step 2.





### Description

The system allows up to eight general purpose relays using PGD(2)-U10 ADP's (four relays per PGD unit) and one general purpose relay built into the GCD-CP10 for a maximum of nine relays. These relays are normally opened and can be closed by dialing an access code on any terminal or pressing a preprogrammed function key on any multiline terminal.

The relays can then be set back to an open state by dialing an access code on any terminal or by pressing a preprogrammed function key on any multiline terminal. A relay can also be set back to an open state after a drive timer expires. Each relay can have a separate drive timer, when the relay is in a closed state, and this timer expires, the relay is automatically placed back into an open state.

*Table 2-32 General Purpose Relay Specifications*

General Purpose Relay Specifications	
Contact Configuration	Normally Open
Maximum Load	500mA @24 VDC
Maximum Initial Contact Resistance	50m Ohms

### Conditions

- When relays 5 & 6 of a PGD(2)-U10 are assigned as General Purpose Relays, they cannot be used for Door Box/Page Relays. Therefore it is recommended to first use relays 7 & 8 for General Purpose Relay function allowing relays 5 & 6 to be used for Door Box/Page Relays.
- All General Purpose Relays can be programmed with a drive timer. The drive timer allows the relay to return to the normally opened position after a timer expires not requiring a user to dial a service code or press a line key to set the relay back to the open position.
- The drive timer on a General Purpose Relay can be bypassed by dialing an access code on any terminal or pressing a preprogrammed line key on any multi line terminal.
- Multiline telephones can activate the General Purpose Relay while in a talking state (call must be answered not just a voice announce) by pressing a preprogrammed line key. All other terminal types cannot activate the relay while a call is in progress.
- The General Purpose Relay cannot be activated by DISA.

- With Version 4000 or higher software, General Purpose Relay can be enabled or disabled automatically or by manually dialing the service code.

### Default Settings

Disabled

## System Availability

### Terminals

All Multiline Terminals (using access code)

Multiline Terminal (using line key)

### Required Component(s)

PGD(2)-U10 ADP

GCD-CP10

## Related Features

- ↳ **Analog Communications Interface (ACI)**
- ↳ **Door Box**
- ↳ **Paging, External**

## Guide to Feature Programming

The **Level 1**, **Level 2** and **Level 3** columns indicate the programs that are assigned when programming this feature in the order they are most commonly used. These levels are used with PCPro and WebPro wizards for feature programming.

- Level 1 – these are the most commonly assigned programs for this feature.
- Level 2 – these are the next most commonly assigned programs for this feature.
- Level 3 – these programs are not often assigned and require an expert level working knowledge of the system to be properly assigned.

Program Number	Program Name/Description	Input Data	Default	Level		
				1	2	3
10-03-01 (1)	<b>ETU Setup (DLCA PKG Setup) – Terminal Type (B1)</b> Set up and confirm the Basic Configuration data for terminal type (B1). When using a PGD-U10 for general purpose relay functionality the digital port must be set to one of the valid PGD settings.	0 = Not Set 1 = Multiline Terminal 3 = Bluetooth Cordless Handset 6 = PGD (Paging) 7 = PGD (Tone Ringer) 8 = PGD (Door Box) 9 = PGD (ACI) 10 = DSS Console 11 = --Not Used--	0	✓		
10-03-06	<b>ETU Setup (DLCA PKG Setup) – Terminal Type (B2)</b> Set up and confirm the Basic Configuration data for terminal type (B2). When using a PGD-U10 for general purpose relay functionality the digital port must be set to one of the valid PGD settings.	0 = Not Set 6 = PGD(2)-U10 ADP (Paging) 7 = PGD(2)-U10 ADP (Tone Ringer) 8 = PGD(2)-U10 ADP (Door Box) 9 = PGD(2)-U10 ADP (ACI) 12 = APR (B2 Mode)	0	✓		
10-05-01	<b>General Purpose Relay Setup – Slot No. Physical Port of DLCA Sensor Circuit No.</b> Define which relay circuits (5 ~ 8) on the PGD(2)-U10 ADP are used for General Purpose Relays. A maximum of (8) general purpose relay can be assigned using PGD's. Relay Circuits 5 ~ 8 can be assigned on multiple PGD's. Ex. PGD 1 has relay circuits 5 ~ 8 assigned to system Relay 1 ~ 4. PGD 2 can have relay circuits 5 ~ 8 assigned to system Relay 5 ~ 8.	Slot No: 0 ~ 24 DLCA Port: 0 ~ 16 Relay No: 0, 5 ~ 8 ➤ <i>After each entry, press Transfer to advance to the next entry.</i>	0 - 0 - 0	✓		
10-05-02	<b>General Purpose Relay Setup – Drive Timer Setup</b> The drive timer controls how long the relay is in a closed state before automatically changing back to an open state.	0-64800 0 = No drive timer 1 = 0.1 seconds 2 = 0.2 seconds 3 = 0.3 seconds . . 64800 = 6480 (seconds)	0		✓	
10-21-05	<b>GCD-CP10 Hardware Setup – General Purpose Relay Switch on GCD-CP10</b> Used to enable/disable the General Purpose Relay that is built into the GCD-CP10.	0 = Off 1 = Relay 1 on GCD-CP10 2 = Relay 2 on GCD-CP10	0		✓	
10-21-06	<b>GCD-CP10 Hardware Setup – Drive Timer Setup on GCD-CP10</b> The drive timer controls how long the relay is in a closed state before automatically changing back to an open state.	0-64800 0 = No drive timer 1 = 0.1 seconds 2 = 0.2 seconds 3 = 0.3 seconds . . 64800 = 6480 (seconds)	0		✓	

Program Number	Program Name/Description	Input Data	Default	Level		
				1	2	3
11-12-50	<p><b>Service Code Setup (for Service Access) – General Purpose Relay</b></p> <p>This is the access code to enable/disable the General Purpose relays.</p> <p>After dialing the service code the user must then dial the relay (0 ~ 8) to enable/disable the relays.</p> <p>0 = Relay on GCD-CP10 1 ~ 8 = Relay assigned on PGD</p>	<p>MLT, SLT</p> <p>0 ~ 9, *, # Maximum of eight digits</p>	780		✓	
15-07-01	<p><b>Programmable Function Keys</b></p> <p>Assign a function key for General Purpose Relay (Code 51 Add; Relay number 0 ~ 8).</p>	<p>Line Key 1 ~ 48</p> <p>0 ~ 99 (Normal Function Code 751 by default)</p> <p>*00 ~ *99 (Appearance Function Code) (Service Code 752 by default)</p>	Refer to the Programming Manual for default values.		✓	

## Operation

### To Activate a Relay:

#### Multiline Terminal

1. Press **Speaker**.
2. Dial **780**.
3. Dial Relay Number (**0~8**).
  - ◇ 0 is for the relay on the GCD-CP10, 1~8 are relays on the PGD(2)-U10 ADP.

**- OR -**

- 1. Press the Line Key assigned as a General Purpose Relay (the key is lit).

#### Single Line Telephone

1. Lift the handset.
2. Dial **780**.
3. Dial Relay Number (**0~8**).
  - ◇ 0 is for the relay on the GCD-CP10, 1~8 are relays on the PGD(2)-U10 ADP.

### To Cancel a Relay:

#### Multiline Terminal

1. Press **Speaker**.

2. Dial **780**.
3. Dial Relay Number (**0~8**).
  - ◇ 0 is for the relay on the GCD-CP10, 1~8 are relays on the PGD(2)-U10 ADP.
  - OR -
1. Press the Line Key assigned as a General Purpose Relay (the key is not lit).
  - OR -
1. Wait for the drive timer to expire.

**Single Line Telephone**

1. Press **Speaker**.
2. Dial **780**.
3. Dial Relay Number (**0~8**).
  - ◇ 0 is for the relay on the GCD-CP10, 1~8 are relays on the PGD(2)-U10 ADP.
  - OR -
1. Wait for the drive timer to expire.

## Group Call Pickup

### Description

Group Call Pickup allows an extension user to answer a call ringing another extension in a Pickup Group. This permits co-workers in the same work area to easily answer each other's calls. The user can dial a code or press a programmed Group Call Pickup key to intercept the ringing call. If several extensions in the group are ringing at the same time, Group Call Pickup intercepts the call based on the extension priority in the Pickup Group.

With Group Call Pickup, a user can intercept the following calls:

- A call ringing the user's own pickup group
- A call ringing another pickup group when the user knows the group number
- A call ringing another pickup group when the user does not know the group number

There are 64 Call Pickup Groups available.

### Conditions

- A Call Pickup Group cannot have an associated name.
- Group Call Pickup can be used to answer calls recalling from Hold or Park.
- Group Call Pickup can be used to answer calls ringing Call Arrival Keys or Virtual Extensions.
- Virtual Extensions can use Group Call Pickup to answer calls ringing a multiline terminal or single line telephone.
- Users can pickup calls regardless of their access map programming.
- Directed Call Pickup provides another way of answering a co-worker's call.
- Function keys simplify Group Call Pickup operation.

### Default Settings

Enabled

### System Availability

#### Terminals

All Terminals

### Required Component(s)

None

### Related Features

- ➔ [Central Office Calls, Answering](#)
- ➔ [Directed Call Pickup](#)
- ➔ [Programmable Function Keys](#)

### Guide to Feature Programming

The **Level 1**, **Level 2** and **Level 3** columns indicate the programs that are assigned when programming this feature in the order they are most commonly used. These levels are used with PCPro and WebPro wizards for feature programming.

- Level 1 – these are the most commonly assigned programs for this feature.
- Level 2 – these are the next most commonly assigned programs for this feature.
- Level 3 – these programs are not often assigned and require an expert level working knowledge of the system to be properly assigned.

Program Number	Program Name/Description	Input Data	Default	Level		
				1	2	3
11-12-25	<b>Service Code Setup (for Service Access) – Direct Call Pickup - Own Group</b> Customize the Service Codes for direct call pickup – own group.	MLT, SLT 0 ~ 9, *, # Maximum of eight digits	756	✓		
11-12-26	<b>Service Code Setup (for Service Access) – Call Pickup for Specified Group</b> Customize the Service Codes for call pickup for specified group.	MLT, SLT 0 ~ 9, *, # Maximum of eight digits	768	✓		
11-12-27	<b>Service Code Setup (for Service Access) – Call Pickup</b> Customize the Service Codes for call pickup.	MLT, SLT 0 ~ 9, *, # Maximum of eight digits	<b>*#</b>	✓		
11-12-28	<b>Service Code Setup (for Service Access) – Call Pickup for Another Group</b> Customize the Service Codes for call pickup for another group.	MLT, SLT 0 ~ 9, *, # Maximum of eight digits	769	✓		

Program Number	Program Name/Description	Input Data	Default	Level		
				1	2	3
15-07-01	<b>Programmable Function Keys</b> Assign Group Call Pickup keys: Code 24 for an extension Pickup Group and ring group calls (Service Code <b>*#</b> ). Code 25 for a telephone ringing in another Pickup Group when the caller does not know the group number (Service Code 769). Code 26 (+ group) for a telephone ringing in another specific Pickup Group (Service Code 768).	Line Key 1 ~ 48 0 ~ 99 (Normal Function Code 751 by default) <b>*00 ~ *99</b> (Appearance Function Code) (Service Code 752 by default)	Refer to the Programming Manual for default values.	✓		
20-06-01	<b>Class of Service for Extensions</b> Assign a Class of Service (1 ~ 15) to an extension.	Day Night/Mode: 1 ~ 8 Class of Service of Extensions (1 ~ 15)	Extension port 101 = Class 15 All other extension port = Class 1		✓	
20-10-01	<b>Class of Service Options (Answer Service) – Group Call Pickup (Within Group)</b> Enable/Disable an extension user ability to pick up calls ringing into a pickup group (service code <b>*#</b> ).	0 = Off 1 = On	COS 1 ~ 15 = 1	✓		
20-10-02	<b>Class of Service Options (Answer Service) – Group Call Pickup (Another Group)</b> Turn Off or On Group Call Pickup for calls ringing outside a group (Service Code 769).	0 = Off 1 = On	COS 1 ~ 15 = 1	✓		
20-10-03	<b>Class of Service Options (Answer Service) – Group Call Pickup for Specific Group</b> Turn Off or On Group Call Pickup for a specific group using service code 768.	0 = Off 1 = On	COS 1 ~ 15 = 1	✓		
20-10-04	<b>Class of Service Options (Answer Service) – Telephone Call Pickup</b> Enable or Disable the group call pick up.	0 = Off 1 = On	COS 1 ~ 15 = 1	✓		
20-10-05	<b>Class of Service Options (Answer Service) – Directed Call Pickup for Own Group</b> Turn Off or On Directed Call Pickup for calls ringing an extension Pickup Group (Service Code 756).	0 = Off 1 = On	COS 1 ~ 15 = 1	✓		
23-02-01	<b>Call Pickup Groups</b> Assign extensions to Pickup Groups. Also, assign an extension priority in a Pickup Group (Priority Number 1 ~ 9999).	Call Pickup Groups: 1 ~ 9 or 01 ~ 64	1 – xxx	✓		



## Operation

### To answer a call ringing another telephone in your Pickup Group:

1. Pick up the handset or press **Speaker**.
2. At multiline terminal only, press the **Group Call Pickup** key (Program 15-07 or SC 751: 24).

- OR -

Dial **756** or **\*#**.

◇ *Service Code **\*#** can pick up any call in the group, plus any Ring Group calls. Service Code 756 cannot pick up Ring Group calls.*

### To answer a call ringing a telephone in another Pickup Group when you do not know the group number:

1. Pick up the handset or press **Speaker**.
2. At multiline terminal only, press the **Group Call Pickup** key (Program 15-07 or SC 751: 25).

- OR -

Dial **769**.

### To answer a call ringing a telephone in another Pickup Group when you know the group number:

1. Pick up the handset or press **Speaker**.
2. At multiline terminal only, press the **Group Call Pickup** key (Program 15-07 or SC 751: 26 + group).

- OR -

Dial **768** and the group number (1~9 or 01~64).

## Group Listen

### Description

Group Listen permits a multiline terminal user to talk on the handset and have their caller's voice broadcast over the telephone speaker. This lets the multiline terminal user's co-workers listen to the conversation. Group Listen turns off the multiline terminal handsfree microphone so the caller does not pick the co-worker's voices during a Group Listen.

#### Conditions

- An extension in the headset mode cannot use Group Listen.
- Group Listen is not available to single line telephones.

#### Default Settings

Disabled

### System Availability

#### Terminals

All Multiline Terminals

#### Required Component(s)

None

### Related Features

➔ **Headset Operation**

## Guide to Feature Programming

The **Level 1**, **Level 2** and **Level 3** columns indicate the programs that are assigned when programming this feature in the order they are most commonly used. These levels are used with PCPro and WebPro wizards for feature programming.

- Level 1 – these are the most commonly assigned programs for this feature.
- Level 2 – these are the next most commonly assigned programs for this feature.
- Level 3 – these programs are not often assigned and require an expert level working knowledge of the system to be properly assigned.

Program Number	Program Name/Description	Input Data	Default	Level		
				1	2	3
20-06-01	<b>Class of Service for Extensions</b> Assign a Class of Service (1 ~ 15) to an extension.	Day Night/Mode: 1 ~ 8 Class of Service of Extensions (1 ~ 15)	Extension port 101 = Class 15 All other extension port = Class 1		✓	
20-13-26	<b>Class of Service Options (Supplementary Service) – Group Listen</b> Turn Off or On an extension user ability to use Group Listen.	0 = Off 1 = On	COS 1 ~ 15 = 1		✓	

## Operation

### To initiate Group Listen:

1. Place or answer call using the handset.
2. Press **Speaker** twice (but do not hang up).
  - ◇ *Speaker flashes slowly.*
  - ◇ *You can talk to the caller through your handset. Your co-workers hear your caller's voice over your telephone speaker after pressing **Speaker** twice. Press **Speaker** a third time to turn off Group Listening.*

### To talk Handsfree after initiating Group Listen:

1. Hang up the handset.

### To cancel Group Listen (without hanging up your call):

1. Do not hang up.
2. Press the flashing **Speaker**.
  - ◇ *You can talk to the caller over the handset. Your co-workers can no longer hear the caller's voice.*





### Description

Handset Mute is provided to most terminals connected to the UNIVERGE SV9100 system. While talking on the multiline terminal handset, a station user can dial a feature code or press Mic to mute the transmit speech path. The station user can still hear the outside (or intercom) voice.

#### Conditions

- The Mic key or Handset Transmission Cut Off key flashes when active.
- Two service set tones are heard when Handset Mute is activated or deactivated.
- The called party must have answered using handset or speakerphone for the mute feature to work.

#### Default Settings

None

### System Availability

#### Terminals

All Multiline Terminals

#### Required Component(s)

None

### Related Features

↪ **Programmable Function Keys**

## Guide to Feature Programming

The **Level 1**, **Level 2** and **Level 3** columns indicate the programs that are assigned when programming this feature in the order they are most commonly used. These levels are used with PCPro and WebPro wizards for feature programming.

- Level 1 – these are the most commonly assigned programs for this feature.
- Level 2 – these are the next most commonly assigned programs for this feature.
- Level 3 – these programs are not often assigned and require an expert level working knowledge of the system to be properly assigned.

Program Number	Program Name/Description	Input Data	Default	Level		
				1	2	3
<b>15-07-01</b>	<b>Programmable Function Keys</b> Assign a function key for Handset Transmission Cut Off (code 40).	Line Key 1 ~ 48 0 ~ 99 (Normal Function Code 751 by default) *00 ~ *99 (Appearance Function Code) (Service Code 752 by default)	Refer to the Programming Manual for default values.		✓	
<b>80-01-01</b>	<b>Service Tone Setup – Repeat Count</b> Customize the system basic tones and system service tones. The system must be reset for the changes to take effect.	0 ~ 255 (0 = until On-Hook)	Refer to <a href="#">Table 2-33 Service Tone Setup Defaults, Program 80-01-01</a> on <a href="#">page 2-594</a> .			✓
<b>80-01-02</b>	<b>Service Tone Setup – Basic Tone Number</b> The following features require that the system tones listed below be changed to match the table. After changing these settings the system must be reset for the changes to take effect. <ul style="list-style-type: none"> <li>○ Call Screening</li> <li>○ Call Holding</li> <li>○ Busy Greeting</li> <li>○ Await Answer Transfer</li> </ul>	1 ~ 33 (0 = No Tone) (33 = Default Time Slot)	(33 = Default Time Slot) Refer to <a href="#">Table 2-34 Service Tone Setup, Program 80-01-02</a> on <a href="#">page 2-598</a> .			✓

Table 2-33 Service Tone Setup Defaults, Program 80-01-01

Service Tone No.	Service Tone	Repeat Count	Unit Count	Basic Tone No.	Duration	Gain Level (dB)
1	No Tone	0	Basic 1	0	10	32 (0dB)
2	Internal Dial Tone	0	Basic 1	9	10	32 (0dB)
3	Stutter Dial Tone	0	Basic 6	0 9 0 9 0 9	2 1 1 1 1 77	32 (0dB)

Table 2-33 Service Tone Setup Defaults, Program 80-01-01 (Continued)

Service Tone No.	Service Tone	Repeat Count	Unit Count	Basic Tone No.	Duration	Gain Level (dB)
4	Internal Recall Dial Tone	2	Basic 2	9 0	1 1	32 (0dB) 32 (0dB)
5	Trunk Dial Tone	0	Basic 1	9	10	32 (0dB)
6	Internal Busy Tone	0	Basic 2	0 11	5 5	20 (-6dB) 20 (-6dB)
7	DND Busy Tone	0	Basic 2	0 1	2 2	32 (0dB) 32 (0dB)
8	B-Busy Tone	0	Basic 2	0 11	5 5	20 (-6dB) 20 (-6dB)
9	Internal Reorder Tone	0	Basic 2	11 0	3 2	20 (-6dB) 20 (-6dB)
10	Internal Interrupt Tone	0	Basic 2	0 1	1 1	32 (0dB) 32 (0dB)
11	Internal Confirmation Tone	3	Basic 2	0 6	5 1	32 (0dB) 32 (0dB)
12	Internal Hold Tone	0	Basic 0	0	0	32 (0dB)
13	External Hold Tone	0	Basic 0	0	0	32 (0dB)
14	Intercom Ringback Tone	0	Basic 2	9 0	10 20	32 (0dB) 32 (0dB)
15	Override Tone	1	Basic 1	12	5	32 (0dB)
16	Lock-Out Tone	0	Basic 2	0 6	1 1	32 (0dB) 32 (0dB)
17	Clock Alarm Tone	0	Basic 4	6 0 6 0	1 1 1 7	32 (0dB) 32 (0dB) 32 (0dB) 32 (0dB)
18	BGM	0	Basic 0	0	0	32 (0dB)
19	Door Box Chime 1	3	Basic 6	4 4 2 2 2 0	2 2 3 4 6 5	38 (+3dB) 26 (-3dB) 38 (+3dB) 26 (-3dB) 14 (-9dB) 32 (0dB)
20	Door Box Chime 2	3	Basic 6	7 7 5 5 5 0	2 2 3 4 6 5	38 (+3dB) 26 (-3dB) 38 (+3dB) 26 (-3dB) 14 (-9dB) 32 (0dB)
21	Door Box Chime 3	3	Basic 6	8 8 6 6 6 0	2 2 3 4 6 5	38 (+3dB) 26 (-3dB) 38 (+3dB) 26 (-3dB) 14 (-9dB) 32 (0dB)

Table 2-33 Service Tone Setup Defaults, Program 80-01-01 (Continued)

Service Tone No.	Service Tone	Repeat Count	Unit Count	Basic Tone No.	Duration	Gain Level (dB)
22	Door Box Chime 4	3	Basic 6	4	1	38 (+3dB)
				4	1	26 (-3dB)
				2	2	38 (+3dB)
				2	2	26 (-3dB)
				2	3	14 (-9dB)
				0	2	32 (0dB)
23	Door Box Chime 5	3	Basic 6	7	1	38 (+3dB)
				7	1	26 (-3dB)
				5	2	38 (+3dB)
				5	2	26 (-3dB)
				5	3	14 (-9dB)
				0	2	32 (0dB)
24	Door Box Chime 6	3	Basic 6	8	1	38 (+3dB)
				8	1	26 (-3dB)
				6	2	38 (+3dB)
				6	2	26 (-3dB)
				6	3	14 (-9dB)
				0	2	32 (0dB)
25	Service Set Tone	3	Basic 2	0	1	32 (0dB)
				9	1	32 (0dB)
26	Service Clear Tone	3	Basic 2	0	1	32 (0dB)
				9	1	32 (0dB)
27	Talkback Tone	2	Basic 2	0	1	32 (0dB)
				6	1	32 (0dB)
28	Speaker Monitor Tone This tone is what the originator hears when placing a handsfree speaker ICM call.	1	Basic 2	0	1	32 (0dB)
				6	1	32 (0dB)
29	Door Relay Tone	1	Basic 2	0	1	32 (0dB)
				6	1	32 (0dB)
30	Door Box Call Tone	1	Basic 2	0	1	32 (0dB)
				6	1	32 (0dB)
31	Paging Tone	2	Basic 2	0	1	32 (0dB)
				6	1	32 (0dB)
32	Splash Tone 1	1	Basic 2	0	1	32 (0dB)
				6	1	32 (0dB)
33	Splash Tone 2	2	Basic 2	0	1	32 (0dB)
				6	1	32 (0dB)
34	Splash Tone 3	3	Basic 2	0	1	32 (0dB)
				6	1	32 (0dB)
35	1 Second Signal Tone	1	Basic 1	6	10	32 (0dB)
36	External Audible Ring Tone	0	Basic 2	7	2	32 (0dB)
				0	2	32 (0dB)
37	External Reorder Tone	0	Basic 2	7	5	32 (0dB)
				0	5	32 (0dB)



Table 2-33 Service Tone Setup Defaults, Program 80-01-01 (Continued)

Service Tone No.	Service Tone	Repeat Count	Unit Count	Basic Tone No.	Duration	Gain Level (dB)
38	External Busy Tone	0	Basic 2	7 0	7 7	32 (0dB) 32 (0dB)
39	Special Audible Ring Busy Tone	0	Basic 6	0 11 0 11 10 0	5 5 5 5 10 20	32 (0dB) 32 (0dB) 32 (0dB) 32 (0dB) 32 (0dB) 32 (0dB)
40	Internal Call Waiting Tone	1	Basic 1	12	2	32 (0dB)
41	Intrusion Tone	1	Basic 1	12	5	32 (0dB)
42	Conference Tone	0	Basic 0	0	0	32 (0dB)
43	Intrusion Tone 2	0	Basic 1	2	8	32 (0dB)
44	External Dial Tone	0	Basic 1	9	1	26 (-3dB)
45	External Ring Back Tone	0	Basic 2	10 0	10 30	32 (0dB) 32 (0dB)
46	DID Error Tone	0	Basic 2	11 0	5 5	32 (0dB) 32 (0dB)
47	External Busy Tone	0	Basic 1	11	0	32 (0dB)
48	Voice Mail Message Indication Tone	0	Basic 2	9 0	1 1	32 (0dB) 32 (0dB)
49	--- Not Used ---					
50	External Special Audible Ring Tone	0	3	10 12 0	10 2 30	32 (0dB) 32 (0dB) 32 (0dB)
51	External Intercept Tone	0	2	12 4	3 2	32 (0dB) 32 (0dB)
52	External Call Waiting Tone	1	1	12	3	32 (0dB)
53	External Executive Override Tone	1	1	12	10	32 (0dB)
54	Progress Tone	0	2	0 1	6 1	32 (0dB) 32 (0dB)
55	Generate tone for TAPI2.1	0	Basic 1	3	0	32 (0dB)
56	Warning Beep Tone Signaling	1	Basic 1	2	8	32 (0dB)
57	Headset Ear Piece Ringing Tone	0	Basic 5	0 2 0 2 0	2 1 1 1 20	32 (0dB) 32 (0dB) 32 (0dB) 32 (0dB) 32 (0dB)

Table 2-33 Service Tone Setup Defaults, Program 80-01-01 (Continued)

Service Tone No.	Service Tone	Repeat Count	Unit Count	Basic Tone No.	Duration	Gain Level (dB)
58	Opening Chime Tone	1	Basic 8	2	2	32 (0dB)
				2	2	26 (-3dB)
				14	2	32 (0dB)
				14	2	26 (-3dB)
				15	2	32 (0dB)
				15	2	26 (-3dB)
				16	6	32 (0dB)
16	4	26 (-3dB)				
59	Ending Chime Tone	1	Basic 8	20	2	32 (0dB)
				20	2	26 (-3dB)
				19	2	32 (0dB)
				19	2	26 (-3dB)
				18	2	32 (0dB)
				18	2	26 (-3dB)
				17	6	32 (0dB)
17	4	26 (-3dB)				
60	Splash Tone 1 (Mute)	1	Basic 2	0	1	8 (-12dB)
				6	1	8 (-12dB)
61	Splash Tone 2 (Mute)	2	Basic 2	0	1	8 (-12dB)
				6	1	8 (-12dB)
62	Splash Tone 3 (Mute)	3	Basic 2	0	1	8 (-12dB)
				6	1	8 (-12dB)
63	EXT SPK Ring-back Tone	0	Basic 2	10	10	32 (0dB)
				0	30	32 (0dB)
64	Music on Hold (MOH)	0	0	0	0	32 (0dB)

Table 2-34 Service Tone Setup, Program 80-01-02

Item No.	Item	Repeat Count
02	Basic Tone Number	0~33 (0 = No Tone) (33=Default Time Slot)
03	Duration Count	0~255 (100~25500ms)
04	Gain Level (dB)	0~57 (-15.5 ~ +12.5)

## Operation

### While talking on a terminal handset:

1. Press **MIC**.  
- OR -
2. Press **Feature** + dial **1**.  
- OR -
3. Press the **Handset Transmission Cut-Off** key (Program15-07-01; Key 40 or SC 751 Key Code 40).

## Handsfree and Monitor

### Description

Handsfree allows a multiline terminal user to process calls using the speaker and microphone in the telephone instead of the handset. Handsfree is a convenience for workers who do not have a free hand to pick up the handset. For example, a terminal operator could continue to enter data with both hands while talking on the telephone.

Three variations of Handsfree are available:

- Handsfree  
The user can press Speaker to place and answer calls instead of using the handset.
- Automatic Handsfree  
The user can press a trunk line key or virtual extension key without lifting the handset or press Speaker. An extension can have Automatic Handsfree for outgoing calls or for both outgoing calls and incoming calls.
- Monitor  
User can place a call without lifting the handset, but must lift the handset to speak.

### Conditions

- Handsfree and Monitor are not available for single line telephones.
- Prime Line Selection affects how incoming and outgoing calls are handled and thus determines what happens when the user presses Speaker.
- Monitoring volume may be adjusted using the volume control on the multiline terminal.
- When a multiline terminal user lifts the handset, the monitoring condition is automatically released, and the Speaker LED goes off.
- A multiline terminal is considered off-hook by the system when this feature is used.

### Default Settings

Enabled

## System Availability

### Terminals

All Multiline Terminals

### Required Component(s)

None

## Related Features

- ➔ **Central Office Calls, Answering**
- ➔ **Central Office Calls, Placing**
- ➔ **Microphone Cutoff**
- ➔ **Prime Line Selection**

## Guide to Feature Programming

The **Level 1**, **Level 2** and **Level 3** columns indicate the programs that are assigned when programming this feature in the order they are most commonly used. These levels are used with PCPro and WebPro wizards for feature programming.

- Level 1 – these are the most commonly assigned programs for this feature.
- Level 2 – these are the next most commonly assigned programs for this feature.
- Level 3 – these programs are not often assigned and require an expert level working knowledge of the system to be properly assigned.

Program Number	Program Name/Description	Input Data	Default	Level		
				1	2	3
15-02-08	<b>Multiline Telephone Basic Data Setup – Automatic Handsfree</b> Set whether pressing a key accesses a One-Touch Key or preselects the key.	0 = Preselect 1 = One-Touch (Automatic Handsfree)	1		✓	
15-02-16	<b>Multiline Telephone Basic Data Setup – Handsfree Operation</b> Enable/Disable an extension user ability to use the speakerphone on outside calls. When disabled, the user can hear the conversation, but cannot respond handsfree.	0 = Disable 1 = Enable	1		✓	

Program Number	Program Name/Description	Input Data	Default	Level		
				1	2	3
20-02-12	<b>System Options for Multiline Telephones – Forced Intercom Ring (ICM Call Type)</b> Enable/Disable Forced Intercom Ringing. If enabled, incoming Intercom calls normally ring. If disabled, Intercom calls voice-announce.	0 = Disable (Voice) 1 = Enable (Signal)	0		✓	
20-06-01	<b>Class of Service for Extensions</b> Assign Class of Service (1 ~ 15) for extensions.	Day Night/Mode: 1 ~ 8 Class of Service of Extensions (1 ~ 15)	Extension port 101 = Class 15 All other extension port = Class 1		✓	
20-09-05	<b>Class of Service Options (Incoming Call Service) – Signal/Voice Call</b> Turn Off or On an extension user ability to enable Handsfree Answerback or Forced Intercom Ringing for their incoming Intercom calls.	0 = Off 1 = On	COS 1 ~ 15 = 1		✓	

## Operation

### To talk Handsfree:

1. Press **Speaker, Trunk Line** key or **Virtual Extension** key.
2. Place the call.
3. Speak toward the telephone when the called party answers.

### To change a handset call to a Handsfree call:

1. Press **Speaker** and hang up the handset.
2. Press **Speaker** again to hang up.

### To change a Handsfree call to a handset call:

1. Lift the handset.

### To turn on/off Monitor:

1. Press **MIC**, Feature + 1, or the Microphone Function Key (Program 15-07 or SC 751 : 02) to turn on or off the Microphone.
  - ◇ *Monitor is off when **MIC LED** is lit, the Microphone Function Key is lit, or the handset is lifted.*

## *Handsfree Answerback/Forced Intercom Ringing*

### Description

Handsfree Answerback permits an extension user to respond to a voice-announced Intercom call by speaking toward the telephone, without lifting the handset. Like Handsfree, this is a convenience for workers who do not have a free hand to pick up the handset.

### Conditions

- Handsfree Answerback does not require the Speaker phone to be enabled (Program 15-02-16).
- A multiline terminal user can process calls using the speaker and microphone in the telephone (instead of the handset).
- With Microphone Cutoff enabled, Handsfree Answerback callers to an extension hear a single beep (instead of two).
- Incoming Intercom calls always ring single line telephones.
- The extension you are calling must be set to Voice for this feature to work.

### Default Setting

Enabled

### System Availability

#### Terminals

All Multiline Terminals

#### Required Component(s)

None

### Related Features

- ➔ **Handsfree and Monitor**
- ➔ **Microphone Cutoff**

## Guide to Feature Programming

The **Level 1**, **Level 2** and **Level 3** columns indicate the programs that are assigned when programming this feature in the order they are most commonly used. These levels are used with PCPro and WebPro wizards for feature programming.

- Level 1 – these are the most commonly assigned programs for this feature.
- Level 2 – these are the next most commonly assigned programs for this feature.
- Level 3 – these programs are not often assigned and require an expert level working knowledge of the system to be properly assigned.

Program Number	Program Name/Description	Input Data	Default	Level		
				1	2	3
11-11-15	<b>Service Code Setup (for Setup/Entry Operation) – Enable Handsfree Incoming Intercom Calls</b> If required, change the service code used for setting an extension to voice announce for incoming ICM calls.	MLT 0 ~ 9, *, # Maximum of eight digits	721		✓	
11-11-16	<b>Service Code Setup (for Setup/Entry Operation) – Force Ringing of Incoming Intercom Calls</b> If required, change the service code used for setting an extension to forced ringing for incoming ICM calls.	MLT 0 ~ 9, *, # Maximum of eight digits	723		✓	
11-12-06	<b>Service Code Setup (for Service Access) – Switching of Voice Call and Signal Call</b> If required, change the service code used for toggling an outgoing ICM call between a voice call and signal call.	MLT, SLT 0 ~ 9, *, # Maximum of eight digits	712		✓	
15-02-16	<b>Multiline Telephone Basic Data Setup – Handsfree Operation</b> Enable/Disable an extension user ability to use the speakerphone on outside calls. When disabled, the user can hear the conversion, but cannot respond handsfree.	0 = Disable 1 = Enable	1		✓	
20-02-12	<b>System Options for Multiline Telephones – Forced Intercom Ring (ICM Call Type)</b> Enable/Disable Forced Intercom Ringing. If enabled, incoming Intercom calls normally ring. If disabled, Intercom calls voice-announce.	0 = Disable (Voice) 1 = Enable (Signal)	0		✓	
20-06-01	<b>Class of Service for Extensions</b> Assign a Class of Service (1 ~ 15) to an extension.	Day Night/Mode: 1 ~ 8 Class of Service of Extensions (1 ~ 15)	Extension port 101 = Class 15 All other extension port = Class 1		✓	



Program Number	Program Name/Description	Input Data	Default	Level		
				1	2	3
20-08-10	<b>Class of Service Options (Outgoing Call Service) – Signal/Voice Call</b> Enable/Disable an extension user ability to toggle between Handsfree Answerback and Forced Intercom Ringing for outgoing Intercom calls (dial 1 or Service Code 712).	0 = Off 1 = On	COS 1 ~ 15 = 1		✓	
20-09-05	<b>Class of Service Options (Incoming Call Service) – Signal/Voice Call</b> Turn Off or On an extension user ability to enable Handsfree Answerback or Forced Intercom Ringing for their incoming Intercom calls.	0 = Off 1 = On	COS 1 ~ 15 = 1		✓	

## Operation

### To enable Handsfree Answerback for your incoming Intercom calls:

1. Press idle **Speaker**.
2. Dial **721**.
3. Press **Speaker** to hang up.  
 ◇ *This disables Forced Intercom Ringing.*

### To enable Forced Intercom Ringing for your incoming Intercom calls:

1. Press idle **Speaker**.
2. Dial **723**.
3. Press **Speaker** to hang up.  
 ◇ *This disables Handsfree Answerback.*

### To change the way your Intercom call signals the extension you are calling:

1. Dial **1**.  
 - OR -  
 Dial **712**.  
 ◇ *If ringing, your call voice-announces. If voice-announced, your call starts to ring the destination. This option is also available at single line telephones.*

## Headset Operation

### Description

A multiline terminal user can use a customer-provided headset in place of the handset. Like using Handsfree, using the headset frees up the user's hands for other work. However, Headset Operation provides privacy not available from Handsfree.

As the headset plugs in a separate jack on the bottom of the telephone, the handset can still be connected to the telephone. This gives you the option to use the handset, headset or the speakerphone for calls.

### Conditions

- While using the headset, the Headset function key becomes a release (disconnect) key and no dial tone is heard from the speaker.
- While in the headset mode, the hook switch is not functional.
- The Headset Programmable Function key (05) and Headset service code (688) are not available for the Electra Professional telephones.
- An extension with a headset can receive voice-announced Intercom calls and respond handsfree when idle.
- A Headset Function key is required to answer or place a call in headset mode.
- The Electronic Headset Switch (EHS) is only supported on the ITL/DTL-8LD, ITL/DTL-12/24 and ITL-320C terminals.
- The EHS only functions with the Plantronics® CX5xx and Savi® 700 family of wireless headsets.
- For EHS, the Headset key needs to be programmed on LK 25 on the ITL/DTL-12/24 and LK 33 on the ITL/DTL-8LD and ITL-320C terminals.
- The EHS and 8LK are not supported on the same SV9100 terminal.
- Ambient noise and/or conversations close to the headset microphone may trigger beeps heard in the headset. Also, the reorder tone results in beeps heard in the headset.
- When the feature: Headset Operation (with Automatic Answer) is enabled, EHS is not supported.

### Default Setting

Disabled

## System Availability

### Terminals

None

### Required Component(s)

Headset

## Related Features

- ↳ **Handsfree Answerback/Forced Intercom Ringing**
- ↳ **Programmable Function Keys**

## Guide to Feature Programming

The **Level 1**, **Level 2** and **Level 3** columns indicate the programs that are assigned when programming this feature in the order they are most commonly used. These levels are used with PCPro and WebPro wizards for feature programming.

- Level 1 – these are the most commonly assigned programs for this feature.
- Level 2 – these are the next most commonly assigned programs for this feature.
- Level 3 – these programs are not often assigned and require an expert level working knowledge of the system to be properly assigned.

Program Number	Program Name/Description	Input Data	Default	Level		
				1	2	3
11-11-62	<b>Service Code Setup (for Setup/Entry Operation) – Headset Ring Volume Adjustment</b> If needed, change the service code used to adjust the Headset Ring Volume.	MLT 0 ~ 9, *, # Maximum of eight digits	662	✓		
11-11-65	<b>Service Code Setup (for Setup/Entry Operation) – Headset Mode Switching</b> Enable/Disable headset mode.	MLT 0 ~ 9, *, # Maximum of eight digits	No Setting	✓		
15-02-41	<b>Multiline Telephone Basic Data Setup – Incoming Ring Setup</b> Determine if incoming calls ring the speaker or headset.	0 = Speaker Normal Ring 1 = Headset Ring	0		✓	
15-02-42	<b>Multiline Telephone Basic Data Setup – Incoming Off-Hook Ring Setup</b> Determine if incoming off-hook ringing rings the speaker or the headset.	0 = Speaker Off-Hook Ring 1 = Headset Off-Hook Ring	0		✓	

Program Number	Program Name/Description	Input Data	Default	Level		
				1	2	3
15-02-43	<p><b>Multiline Telephone Basic Data Setup – Headset Ring Duration</b></p> <p>If incoming ringing is set for headset, set the duration the call rings the headset before ringing the speaker.</p>	0 = No Switch to Speaker Ring 1 = 10 seconds 2 = 20 seconds 3 = 30 seconds 4 = 40 seconds 5 = 50 seconds 6 = 1 minute	0		✓	
15-07-01	<p><b>Programmable Function Keys</b></p> <p>Assign a function key for Headset Operation (code 05).</p>	Line Key 1 ~ 48 0 ~ 99 (Normal Function Code 751 by default) *00 ~ *99 (Appearance Function Code) (Service Code 752 by default)	Refer to the Programming Manual for default values.	✓		
20-02-05	<p><b>System Options for Multiline Telephones – Headset Busy Mode</b></p> <p>Set the conditions under which a headset extension is busy to incoming callers:</p> <ul style="list-style-type: none"> <li>○ The Headset extension is busy to incoming callers when only one extension appearance is busy (0).</li> <li>- OR -</li> <li>○ Headset extension is busy to incoming callers only when both extension appearances are busy (1).</li> </ul>	0 = No 1 = Yes	0		✓	
20-02-12	<p><b>System Options for Multiline Telephones – Forced Intercom Ring (ICM Call Type)</b></p> <p>Determine whether intercom calls should ring or voice-announce extensions.</p>	0 = Disable (Voice) 1 = Enable (Signal)	0		✓	
20-09-07	<p><b>Class of Service Options (Incoming Call Service) – Call Queuing</b></p> <p>Turn Off or On an extension ability to have calls queued if a call rings the extension when it is busy.</p> <p>➤ Program 20-13-06 must be set to 0 (Off) for this feature to work.</p>	0 = Off 1 = On	COS 1 ~ 15 = 1		✓	
20-13-06	<p><b>Class of Service Options (Supplementary Service) – Automatic Off-Hook Signaling (Automatic Override)</b></p> <p>Allow a busy extension user to Manually (0) or Automatically (1) receive off-hook signals.</p> <p>➤ This setting is to receive incoming call signaling information during call queuing.</p>	0 = Off 1 = On	COS 1 ~ 15 = 1		✓	

## Operation

### To enable the headset:

1. Plug in the headset in the headset jack on the bottom of the telephone.
2. Program a **Headset** key (Program 15-07 or SC 751: 05).
  - ◇ You hear a confirmation beep.

### To use the headset:



- *The Headset key lights when on a call. To disconnect, press the The Headset key lights when on a call. To disconnect, press the Headset key.*
- *You can use the handset for calls or respond to voice-announced Intercom calls with the headset plugged in. The headset only activates when the Headset key is pressed.*

- Press the Headset key to answer a ringing call.
  - OR -
- Press the **Headset** key and then a line key or press **Speaker** then **9** to make an outgoing call.
  - OR -
- Press the **Headset** key to get intercom dial tone.
  - OR -
- If on a call, press the **Headset** key to hang up.

## Description

Hold lets an extension user put a call in a temporary waiting state. The caller on Hold hears silence or Music on Hold, not conversation in the extension user's work area. While the call waits on Hold, the extension user may process calls or use a system feature. Calls left on Hold too long recall the extension that placed them on Hold. Four types of Hold are available:

- System Hold**  
An outside call a user places on Hold flashes the line key (if programmed) at all other multiline terminals. Any multiline terminal user with the flashing line key can pick up the call.
- Exclusive Hold**  
When a user places a call on Exclusive Hold, only that user can pick up the call from Hold. The trunk appears busy to all other multiline terminals that have a key for the trunk. Exclusive hold is important if a user does not want a co-worker picking up their call on Hold.
- Group Hold**  
If a user places a call on Group Hold, another user in the Department Group can dial a code to pick up the call. This lets members of a department easily pick up each other's calls.
- Intercom Hold**  
A user can place an Intercom call on Hold. The Intercom call on Hold does not indicate at any other extension.

### Hold Recall to Operator

Hold Recall to Operator enhances how the system handles calls that are left on hold too long. With Hold Recall to Operator:

- A trunk call recalls the extension that placed it on Hold after the Hold/Exclusive Hold Recall Time.
- The recalling trunk rings the extension that placed it on Hold for the Hold/Exclusive Hold Recall Callback Time.
- After the Hold/Exclusive Hold Recall Callback Time, the trunk call rings the operator.

Hold Recall to Operator applies to trunk calls placed on System Hold, Exclusive Hold or Group Hold. It does not apply to Intercom calls.

### Conditions

- The called extension must lift the handset or press Speaker before the call can be placed on hold.
- Callers on Hold hear Music on Hold, if programmed.
- An extension can have function keys for System Hold and Exclusive Hold.

- Analog single line telephones can use only Exclusive Hold or Group Hold.
- If station A calls station B, and station A puts station B on hold and then calls station C, station C cannot transfer the call.
- For a station to retrieve a held ICM call, the station must have an ICM key assigned in Program 15-07 (\*00).
- The Exclusive Hold Recall Timer is used when an internal call from a Single Line Telephone or 3rd Party SIP telephone is placed on hold.
- On extensions, **Hold Recall to Operator is not supported.**

### Default Setting

Enabled

## System Availability

### Terminals

All Terminals

### Required Component(s)

None

## Related Features

- ➔ **Music on Hold**
- ➔ **Programmable Function Keys**
- ➔ **Single Line Telephones, Analog 500/2500 Sets**

## Guide to Feature Programming

The **Level 1**, **Level 2** and **Level 3** columns indicate the programs that are assigned when programming this feature in the order they are most commonly used. These levels are used with PCPro and WebPro wizards for feature programming.

- Level 1 – these are the most commonly assigned programs for this feature.
- Level 2 – these are the next most commonly assigned programs for this feature.
- Level 3 – these programs are not often assigned and require an expert level working knowledge of the system to be properly assigned.

Program Number	Program Name/Description	Input Data	Default	Level		
				1	2	3
11-12-30	<b>Service Code Setup (for Service Access) – Specified Trunk Answer</b> If required, redefine the service code used to answer a specific trunk which is either ringing or on hold.	MLT, SLT 0 ~ 9, *, # Maximum of eight digits	672		✓	
11-12-33	<b>Service Code Setup (for Service Access) – Group Hold</b> If required, redefine the service code used to answer a specific trunk which is either ringing or on hold.	MLT, SLT 0 ~ 9, *, # Maximum of eight digits	732		✓	
11-12-34	<b>Service Code Setup (for Service Access) – Answer for Group Hold</b> If required, redefine the service code used to answer a specific trunk which is either ringing or on hold.	MLT, SLT 0 ~ 9, *, # Maximum of eight digits	762		✓	
14-01-16	<b>Basic Trunk Data Setup – Forced Release of Held Call</b> Enable/Disable Forced Release of Held Call.	0 = Disable 1 = Enable	0		✓	
14-07-01	<b>Trunk Access Map Setup</b> Set up the Trunk Access Maps. This sets the access options for trunks.	0 = No access 1 = Outgoing access only 2 = Incoming access only 3 = Access only when trunk on Hold 4 = Outgoing access and access when trunk on Hold 5 = Incoming access and access when trunk on Hold 6 = Incoming and Outgoing access 7 = Incoming access, outgoing access and access when trunk on Hold Trunk Access Maps: 1 ~ 400	Access Maps 1 ~ 400 = Trunk Ports 1 ~ 400 assigned with option 7 access (incoming and outgoing access and access when trunk is on Hold).		✓	
15-02-06	<b>Multiline Telephone Basic Data Setup – Hold Key Operating Mode</b> Set the function of the Multiline Hold key.	0 = Normal (Common) 1 = Exclusive Hold	0		✓	



Program Number	Program Name/Description	Input Data	Default	Level		
				1	2	3
15-02-07	<b>Multiline Telephone Basic Data Setup – Automatic Hold for CO Lines</b> When talking on a CO call, and another line key is pressed, the original trunk is placed on Hold or disconnected.	0 = Hold 1 = Disconnect (Cut)	1		✓	
15-02-11	<b>Multiline Telephone Basic Data Setup – Callback Automatic Answer</b> Enable/Disable Callback Automatic Answer.	0 = Disable 1 = Enable	1		✓	
15-06-01	<b>Trunk Access Map for Extensions</b> Assign Trunk Access Maps to extensions.	Trunk Access Maps: 1 ~ 400	1		✓	
15-07-01	<b>Programmable Function Keys</b> Assign a function key for Exclusive Hold (code 45). If an extension has its fixed Hold key reassigned in Program 15-02-06, assign a function key for System Hold (code 44).	Line Key 1 ~ 48 0 ~ 99 (Normal Function Code 751 by default) *00 ~ *99 (Appearance Function Code) (Service Code 752 by default) (*03 + ICM = VE or CAR where ICM is the extension number of the VE or CAR)	Refer to the Programming Manual for default values.		✓	
16-02-01	<b>Department Group Assignment for Extensions</b> Set up the Department Group called by the pilot number and the extension priority when a group is called. Call Pickup Groups are set up in Program 23-02.	Department Groups 1 ~ 64 Priority 1 ~ 9999	Default = 1 extensions in Department Group 1 with priority in port order: Port 1 priority = 1 Port 960 priority = 960		✓	
20-06-01	<b>Class of Service for Extensions</b> Assign a Class of Service (1 ~ 15) to extensions.	Day Night/Mode: 1 ~ 8 Class of Service of Extensions (1 ~ 15)	Extension port 101 = Class 15 All other extension port = Class 1		✓	
20-11-09	<b>Class of Service Options (Hold/Transfer Service) – Group Hold Initiate</b> Turn Off or On an extension user ability to initiate Group Hold (Service Code 732).	0 = Off 1 = On	COS 1 ~ 15 = 1		✓	
20-11-10	<b>Class of Service Options (Hold/Transfer Service) – Group Hold Answer</b> Turn Off or On an extension user ability to pick up a call placed on Group Hold (Service Code 762).	0 = Off 1 = On	COS 1 ~ 15 = 1		✓	
20-11-13	<b>Class of Service Options (Hold/Transfer Service) – Operator Transfer After Hold Callback</b> Turn Off or On an extension user ability to have a call, which recalls from Hold, transfer to the operator.	0 = Off 1 = On	COS 1 ~ 15 = 0		✓	

Program Number	Program Name/Description	Input Data	Default	Level		
				1	2	3
20-17-01	<b>Operator Extension – Operator’s Extension Number</b> Define the extension numbers used by operators.	Maximum of eight digits	101		✓	
24-01-01	<b>System Options for Hold – Hold Recall Time</b> Set the Hold Recall Time. A call on Hold recalls the extension that placed it on Hold after this time.	0 ~ 64800 seconds	90		✓	
24-01-02	<b>System Options for Hold – Hold Recall Callback Time</b> Set the Hold Recall Callback Time. A trunk recalling from Hold rings an extension for this time.	0 ~ 64800 seconds	30		✓	
24-01-03	<b>System Options for Hold – Exclusive Hold Recall Time</b> Set the Exclusive Hold Recall Time. A call on Exclusive Hold recalls the extension that placed it on Hold after this time.	0 ~ 64800 seconds	90		✓	
24-01-04	<b>System Options for Hold – Exclusive Hold Recall Callback Time</b> Set the Hold Recall Time. A trunk recalling from Hold rings an extension for this time. If still unanswered, the call changes to System Hold.	0 ~ 64800 seconds	30		✓	
24-01-05	<b>System Options for Hold – Forced Release of Held Call</b> Set the Forced Release of Held Calls time. If enabled in Program 14-01-16, the system disconnects a call if on Hold longer than this Time.	0 ~ 64800 seconds	1800		✓	

## Operation

### System Hold

#### To place an outside call on System Hold:

Press **Hold**.

#### To pick up an outside call on System Hold:

Press the flashing **CAP** key.

- OR -

If you know the specific line number, dial **672** + Line number (**001~400**).

**Exclusive Hold**

**To place an outside call on Exclusive Hold:**

Press the **Exclusive Hold** key (Program 15-07-01 or SC 751: 45).

- OR -

Press **Feature + Hold**.

Single Line Telephone

1. Hookflash.
2. Dial **749**.

**To pick up an outside call on Exclusive Hold:**

Press flashing **CAP** key.

Single Line Telephone

Dial **759**.

**Group Hold**

**To place a call on Hold so anyone in your Department Group can pick it up:**

1. Press **Hold**.
2. Dial **732**.
3. Press **Speaker** to hang up.

Single Line Telephone

1. Hookflash.
2. Dial **732**.
3. Hang up.

**To pick up a call on Group Hold:**

1. Press **Speaker**.
2. Dial **762**.

**Single Line Telephone**

1. Lift the handset.
2. Dial **762**.

## Intercom Hold

### To place an Intercom call on Intercom Hold:

1. Press **Hold**.
2. Press **Speaker** to hang up.

### To pick up an Intercom call on Intercom Hold:

1. Press **Speaker**.
2. Press flashing ICM Key (\*00).

## Hotel/Motel

### Description

Your UNIVERGE SV9100 telephone system provides Hotel/Motel services in addition to the many features available to business users. These Hotel/Motel services help you run your facility more efficiently, save you time and money **and** provide your guests with more responsive service.

Hotel/Motel features include:

#### Wake Up Call/Snooze Callback

Wake Up Call is like having an alarm clock in each room – with some unique advantages:

- Guests can set or cancel Wake Up Calls for themselves, or you can set and cancel Wake Ups for them.
- Unanswered Wake Up Calls can automatically call the operator and print on the Room Status Printout report.
- Use Wake Up Call as a meeting reminder (e.g., for convention attendees).
- When used with the VRS feature, the destination is a single line room telephone Wake Up call providing a pre-recorded greeting to the guest.
- Guests can set Snooze Callback (Version 3.00 or higher required).

#### Single Digit Dialing

Single Digit Dialing gives your guests one-touch access to your important Hotel/Motel services. They can lift the handset and press a single key for:

- Extensions such as the front desk, reservation services, housekeeping or the maitre d' of your restaurant.
- Feature Access Codes for one-button access to selected features and outside lines.
- Voice Mail, so your guests can leave requests even when your service providers are unavailable.

#### A Department Calling Group

A Department Calling Group, allowing, for example, your guests to reach the first available agent in your reservation desk group.

#### Message Waiting

If you call a guest while they are away from their room, leave them a Message Waiting. When the guest returns, they see the lamp on their phone flashing and can automatically call you back. You can use Message Waiting when you have parcels for a guest dropped off at your front desk. Do not keep redialing the guest if they are not in – just send them a Message Waiting. (Your DSS Console can show all the rooms that have messages waiting.)

## PMS Integration

The UNIVERGE SV9100 can support third party Property Management System (PMS) applications. This requires either the PVA PMS blade or, if running Version 5.00.00 or higher software, the Lua PMS application can be installed on the GCD-CP10. The PVA PMS and Lua PMS serve as a gateway between the PMS application, the UNIVERGE SV9100 and UM8000 Mail voice mail.

When using UM8000 Mail voice mail with the PVA PMS, you must have the PVA PMS VM Interface adapter (stock number 670534) and the USB to Serial Adapter (stock number 670545). When using the UM8000 with Lua PMS you will need PMS VM Interface adapter (stock number 670534) and a locally provided serial to IP converter. This will allow the UM8000 to connect via the LAN to the Lua PMS which only supports IP connections.

Additionally, any voice mail used must be licensed for the Hotel feature and have PMS enabled. Refer to the appropriate voice mail installation manual for information on configuring the voice mail.

- With Version 11.9.0.12 or higher, the UM8000 Mail supports IP integration to Lua PMS for hotel features when properly licensed.
- When the SV9100 is interfaced with an external PMS application, the first operator extension set in Program 20-17-01 must be a physical phone connected to the phone system for all PMS features to work.
- The UNIVERGE SV9100 and UM8000 Mail must be licensed for Hotel/Motel for this feature to work.
- The supported Lua PMS and PVA PMS protocols are NEAX 90-K, NEAX 60-K, KTSi and KTSi with ENQ.
- The chassis to PVA PMS connection is via the LAN and an IP port only (default is 5129).
- The PVA PMS to voice mail connection is via serial port COM 2 only using a NULL MODEM or reverse cable.
- The Lua PMS Application does not support serial connections.
- Room name can only be displayed on terminals set to 0 (Normal) in Program 42-02-01.
- All COM ports on the PVA PMS are fixed at 9600 baud, eight data bits, one stop bit, and no parity.
- The NEAX-90 with and without NAK protocol is compatible with property management systems that support NEAX-90 protocol. Note that not all messages or functionality supported by NEAX Model 90 protocol is implied or provided by the NEC PMS. The NEC PMS in conjunction with the UNIVERGE SV9100 provides a subset of features supported by NEAX Model 90 protocol.



— *Refer to the UNIVERGE SV9100 Hotel/Motel Services Guide for complete programming information.*

### Station Name Display via a Virtual Loopback

With Version 5000 or higher, station name sent by PMS can be displayed on Multiline Terminal display when an incoming call to Contact Center Group comes through the virtual loopback from a hotel terminal.

Figure 2-26 Station Name Display via Virtual Loopback

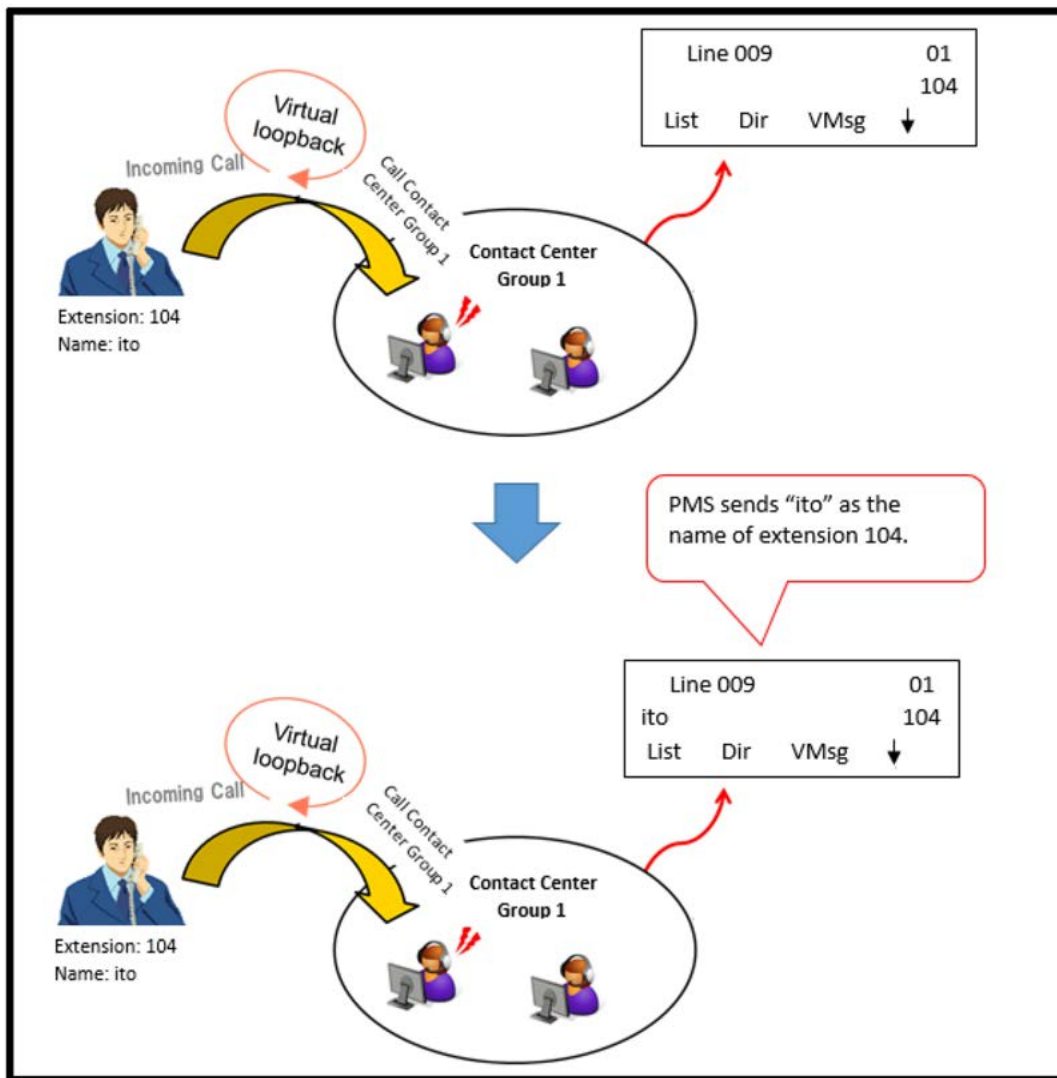

- The name sent by PMS is displayed on Multiline Terminal (member of Contact Center group) if caller is a hotel terminal.
- The name of caller is displayed when incoming call starts ringing.
- When there are many terminals in the Contact Center Group and the representative terminal is not answered and goes to OFF duty mode, the other terminal rings and the name of the caller is displayed.

- The name of the caller is not displayed when the incoming call comes to the Contact center group through a virtual loopback if it is not checked-in with PMS.
- The name sent by PMS displays a maximum of 12 characters if Program 20-02-15 is set to **Name and number**.
- The name sent by PMS displays a maximum of 20 characters if Program 20-02-15 is set to **Name**.
- The name sent by PMS can not be displayed if Program 20-02-15 is set to **Number**.
- The name sent by PMS is displayed if the Caller ID is registered for a speed dial.



— Refer to the *UNIVERGE SV9100 Hotel/Motel Services Guide for complete programming information.*

### Room to Room Calling Restriction

Prevent guests in one room from calling guests in another – a handy feature for guests that want to maintain their privacy. If you need to, you can always allow inter-room calling (e.g., for families or groups that have separate rooms).

### Toll Restriction (When Checked In)

Control a guest's long distance dialing automatically when they check in. Use this feature to set up two different Toll Restriction modes. The first mode is for you and your staff when the room is checked out. The second mode is for your guests when they check in. You may want to restrict the outside numbers guests can dial, but allow your staff to call vendors and suppliers.

### Room Status

Your phone and DSS Console can set and monitor the status of all your guest rooms: *Checked In*, *Checked Out*, *Maid Required* and *Maid in Room*. Maximize room usage by coordinating your cleaning staff and reservation desk. For example, you can dial simple codes to set a room status.

### Room Status Printouts

The Room Status Printouts give you a concise overview of the status of all your guest rooms at a glance. The printouts provide up to the minute reports showing Room Status, Room Call Restriction, Do Not Disturb, Message Waiting and Wake Up Calls. If your cleaning staff needs to know which rooms to clean, for example, just print out the report showing Room Status. This printout requires a connection to the system using an IP post on the CPU.

### DSS Console Monitoring

Your DSS Console provides room monitoring abilities. You can see at a glance which rooms have Wake Up Calls set or messages waiting. In addition, you can still use your console for business mode features.

### Do Not Disturb

A guest can activate DND anytime they need privacy (for example, if they need to work uninterrupted). Do Not Disturb (DND) blocks the room telephone incoming calls and Paging announcements. This can be set from the room phone or attendant phone.



## Flexible Numbering Plan

To simplify dialing guests and services in your facility, customize your system to have room numbers match phone extension numbers. For example, if the rooms on the first floor are numbered 100~120, the corresponding room extensions should also be 100~120.

### Enhancements

- With Version 3000 (3.00 or higher), guests have the ability to set Wake Up Call/Snooze Callback.
- With Version 4.00.53 or higher, Standard SIP phones are supported as hotel room phones.
- With Version 5.00.00 or higher, Lua PMS is supported via IP.

### Conditions

- Lua PMS and CD-PVAA with the PVA PMS application cannot be installed at the same time.
- Standard SIP phones do not support the Hotel Room Monitor feature.
- Support of standard SIP phones for Hotel Motel requires SV9100 Version 4.00.53 or higher.
- Standard SIP Hotel phones do not receive confirmation tones when setting or canceling room options such as Wakeup Calls.
- Standard SIP room phones will show the name provided by PMS on check in when calling other Standard SIP room phones.
- Standard SIP phones must support RFC 3842 (Message Waiting) to receive Message Waiting Lamp indications from voice mail, PMS or the front desk phone.
- The ability to set room status codes \* or # from a Standard SIP phone depends on the SIP phone's dial plan settings.
- The ability to dial access codes that start with \* or # from a Standard SIP phone depends on the SIP phone's dial plan settings.
- Standard SIP phones are not recommended as front desk phones due to possible issues dialing \* and # for room status and dial access codes.
- Wakeup Call status messages do not display on Standard SIP phones.
- The following features are supported:
  - View current room status in Program 42-02-03 via Web Pro and Phone Pro.
  - Use Program 42-01-06 to enable (1) or disable (0) the ability to change any room status to another room status.
  - Set room status on check out using Programs 42-06-07 and 42-06-08.

- When setting room status automatically on check out, you cannot set a room to **Room Clean (Occupied)** from the room using access code 640. This status can only be changed from the front desk telephone (access code 641).
- When Program 42-01-06 is disabled, valid room status changes are limited. Refer to the PMS Developer Guide for information on valid status changes.
- The current room status in Program 42-02-03 cannot be checked via PCPro.
- When the system is configured for the VRS feature, Wake Up call greetings to single line room telephones are supported.
- Wakeup calls to multiline room telephones do not provide a wake up call greeting and can not set Snooze Callback.
- Wake Up call greetings to single line room telephones require the VRS feature and licensing.
- Wake Up Call/Snooze Callback is set automatically if a user answers and no DTMF receiver is available.
- After a user answers a Wake Up Call, the VRS Message is repeated three times. A busy tone is played and Wake Up Call/Snooze Callback is canceled if the digit set in Program 42-01-08 is not pressed.
- When the SV9100 is interfaced with an external PMS application, the first operator extension set in Program 20-17-01 must be a physical phone connected to the phone system for all PMS features to work.
- The SV9100 supports only one CD-PVAA with the PVA PMS application.
- The CD-PVAA is chassis specific. A UX5000 CD-PVAA cannot be used in a SV9100 chassis. Conversely, a SV9100 CD-PVAA cannot be used in a UX5000 chassis.
- The PVA PMS web interface supports Windows Internet Explorer 8 run on any Windows 7 operating system.
- Function codes 92 and 93 can be assigned only to a DSS Console that is in Hotel Mode. These features do not work when programmed on multiline telephone line keys or on a DSS Console in Business mode.
- When multiple DSS Consoles are used for Hotel/Motel, function keys must be assigned to each DSS console for Wake Up Call Indication and Room Status Indication.
- The Message Waiting status of a room cannot be seen when the console is in Wake Up Call or Room Status mode.
- The BLF indication for each room is always available no matter what mode the console is assigned.
- To check the version number (while the application is running) press ALT + V.
- Standard SIP telephones are not supported for Hotel/Motel when using Version 4.00.50 or lower.

- The Hotel/Motel feature requires the GCD-CP10 be licensed for Hotel. The following dial access codes can be used only if the GCD-CP10 is licensed for the Hotel/Motel Feature:

Dial Access Codes that Require GCD-CP10 Hotel License		
Program	Dial Access Code	Description
11-10-16	626	Leaving Message Waiting (Requires CPU to be licensed for Hotel/Motel)
11-14-01	627	Set DND for Own Extension
11-14-02	628	Cancel DND for Own Extension
11-14-03	629	Set DND for Other Extension
11-14-04	630	Cancel DND for Other Extension
11-14-05	631	Set Wake Up Call for Own Extension
11-14-06	632	Cancel Wake Up Call for Own Extension
11-14-07	633	Set Wake Up Call for Other Extension
11-14-08	634	Cancel Wake Up Call for Other Extension
11-14-09	635	Set Room to Room Call Restriction
11-14-10	636	Cancel Room to Room Call Restriction (Hotel)
11-14-11	637	Change Toll Restriction Class for Other Extension
11-14-12	638	Check In
11-14-13	639	Check Out
11-14-14	640	Room Status Change for Own Extension
11-14-15	641	Room Status Change for Other Extension
11-14-16	642	Room Status Output
11-14-17	675	Hotel Room Monitor
11-14-18	666	Set Hotel PMS Code Restriction

Refer to the tables below for valid status code changes when Program 42-01-06 is enabled or disabled.

Table 2-35 Valid Room Status Changes when Program 42-01-06 is set to 1 (Enabled)

Change Status	Code 1	Code 2	Code 3	Code 4	Code 5	Code 6	Code 7	Code 8	Code 9	Code 0	Code *	Code #
Original Status												
Code 1	Y	Y	Y	Y	Y	Y	Y	Y	Y	Y	Y	Y
Code 2	Y	Y	Y	Y	Y	Y	Y	Y	Y	Y	Y	Y
Code 3	Y	Y	Y	Y	Y	Y	Y	Y	Y	Y	Y	Y
Code 4	Y	Y	Y	Y	Y	Y	Y	Y	Y	Y	Y	Y
Code 5	Y	Y	Y	Y	Y	Y	Y	Y	Y	Y	Y	Y

Table 2-35 Valid Room Status Changes when Program 42-01-06 is set to 1 (Enabled) (Continued)

Code 6	Y	Y	Y	Y	Y	Y	Y	Y	Y	Y	Y	Y
Code 7	Y	Y	Y	Y	Y	Y	Y	Y	Y	Y	Y	Y
Code 8	Y	Y	Y	Y	Y	Y	Y	Y	Y	Y	Y	Y
Code 9	Y	Y	Y	Y	Y	Y	Y	Y	Y	Y	Y	Y
Code 0	Y	Y	Y	Y	Y	Y	Y	Y	Y	Y	Y	Y
Code *	Y	Y	Y	Y	Y	Y	Y	Y	Y	Y	Y	Y
Code #	Y	Y	Y	Y	Y	Y	Y	Y	Y	Y	Y	Y

Table 2-36 Valid Room Status Changes when Program 42-01-06 is set to 0 (Disabled)

Change Status	Code 1	Code 2	Code 3	Code 4	Code 5	Code 6	Code 7	Code 8	Code 9	Code 0	Code *	Code #
Original Status												
Code 1	N	Y	N	N	Y	Y	Y	Y	Y	N	Y	Y
Code 2	Y	N	Y	Y	Y	Y	Y	Y	Y	Y	Y	Y
Code 3	Y	Y	N	Y	Y	Y	Y	Y	Y	Y	Y	Y
Code 4	Y	Y	N	N	Y	Y	Y	Y	Y	Y	Y	Y
Code 5	Y	Y	Y	Y	N	Y	Y	Y	Y	Y	Y	Y
Code 6	Y	Y	Y	Y	Y	N	Y	Y	Y	Y	Y	Y
Code 7	Y	Y	Y	Y	Y	Y	N	Y	Y	Y	Y	Y
Code 8	Y	Y	Y	Y	Y	Y	Y	N	Y	Y	Y	Y
Code 9	Y	Y	Y	Y	Y	Y	Y	Y	N	Y	Y	Y
Code 0	Y	Y	N	N	Y	Y	Y	Y	Y	N	Y	Y
Code *	Y	Y	Y	Y	Y	Y	Y	Y	Y	Y	N	Y
Code #	Y	Y	Y	Y	Y	Y	Y	Y	Y	Y	Y	N

## Default Settings

Not Enabled

## System Availability

### Terminals

Multiline IP and TDM terminals, Analog and Standard SIP Terminals

## Required Component(s)

DSS Console

When using the PMS integration in the following licenses affect this feature:

- 0007 – SV9100 HM Lic  
0046 – SV9100 PMS Lic, spare On/Off PMS license

The above licenses are required to enable the Hotel feature in the SV9100 for the PVA PMS and Lua PMS application.

- 3513 – SV9100 Lua PMS Lic

The above license is only required when using the Lua PMS application for PMS integration.

- 6201 – SV9100 PVA-PMS US Lic

The above license is only required when using the PVA PMS for PMS integration.

- 1407 – SV91/93 UM8000 Hospitality & PMS Lic

The above license is only required when using the UM8000 Mail hotel features such as PMS integration and Hotel Guest room mailboxes.

- 0413 – SV9100 Version Lic (R3)

The above license is required for the Wake Up Call/Snooze Callback feature.

- Lua Application Manager 1.1.5 (Required for Lua PMS).

## Related Features

- [Code Restriction](#)
- [Department Calling](#)
- [Do Not Disturb](#)
- [Flexible System Numbering](#)

## Guide to Feature Programming

The **Level 1**, **Level 2** and **Level 3** columns indicate the programs that are assigned when programming this feature in the order they are most commonly used. These levels are used with PCPro and WebPro wizards for feature programming.

- Level 1 – these are the most commonly assigned programs for this feature.
- Level 2 – these are the next most commonly assigned programs for this feature.
- Level 3 – these programs are not often assigned and require an expert level working knowledge of the system to be properly assigned.

◇ *The items highlighted in gray are read only and cannot be changed.*



— *Refer to the UNIVERGE SV9100 Hotel/Motel Services Manual for complete programming information.*

Program Number	Program Name/Description	Input Data	Default	Level		
				1	2	3
10-20-01	<b>LAN Setup for External Equipment – TCP Port</b> Define the TCP port (0 ~ 65535) when communicating to the SMDR (type 5).	0 ~ 65535	External Device 1 (CTI Server) = 0 External Device 2 ( MIS) = 4000 External Device 5 (SMDR Output) = 0 External Device 6 (DIM Output) = 0 External Device 11 (O&M Server) = 8010 External Device 12 (Traffic Report Output) = 0 External Device 13 (Room Data Output for Hotel Service ) = 0		✓	
11-10-16	<b>Service Code Setup (for System Administrator) – Leaving Message Waiting (Requires CPU to be licensed for Hotel/Motel)</b> Customize the leave message waiting Service Codes for the System Administrator (GCD-CP10 must be licensed for Hotel/Motel).	MLT 0 ~ 9, *, # Maximum of eight digits	626		✓	

Program Number	Program Name/Description	Input Data	Default	Level		
				1	2	3
11-14-01	<b>Service Code Setup (for Hotel) – Set DND for Own Extension</b> Customize the set DND for own extension used with the Hotel/Motel feature (GCD-CP10 must be licensed for Hotel/Motel).	MLT, SLT 0 ~ 9, *, # Maximum of eight digits	627		✓	
11-14-02	<b>Service Code Setup (for Hotel) – Cancel DND for Own Extension</b> Customize the cancel DND for own extension used with the Hotel/Motel feature (GCD-CP10 must be licensed for Hotel/Motel).	MLT, SLT 0 ~ 9, *, # Maximum of eight digits	628		✓	
11-14-03	<b>Service Code Setup (for Hotel) – Set DND for Other Extension</b> Customize the set DND for other extension used with the Hotel/Motel feature (GCD-CP10 must be licensed for Hotel/Motel).	MLT, SLT 0 ~ 9, *, # Maximum of eight digits	629		✓	
11-14-04	<b>Service Code Setup (for Hotel) – Cancel DND for Other Extension</b> Customize the cancel DND for other extension used with the Hotel/Motel feature (GCD-CP10 must be licensed for Hotel/Motel).	MLT, SLT 0 ~ 9, *, # Maximum of eight digits	630		✓	
11-14-05	<b>Service Code Setup (for Hotel) – Set Wake Up Call for Own Extension</b> Customize the set wake up call for own extension used with the Hotel/Motel feature (GCD-CP10 must be licensed for Hotel/Motel).	MLT, SLT 0 ~ 9, *, # Maximum of eight digits	631		✓	
11-14-06	<b>Service Code Setup (for Hotel) – Cancel Wake Up Call for Own Extension</b> Customize the cancel wake up call for own extension used with the Hotel/Motel feature (GCD-CP10 must be licensed for Hotel/Motel).	MLT, SLT 0 ~ 9, *, # Maximum of eight digits	632		✓	
11-14-07	<b>Service Code Setup (for Hotel) – Set Wake Up Call for Other Extension</b> Customize the set wake up call for other extension used with the Hotel/Motel feature (GCD-CP10 must be licensed for Hotel/Motel).	MLT, SLT 0 ~ 9, *, # Maximum of eight digits	633		✓	
11-14-08	<b>Service Code Setup (for Hotel) – Cancel Wake Up Call for Other Extension</b> Customize the cancel wake up call for other extension used with the Hotel/Motel feature (GCD-CP10 must be licensed for Hotel/Motel).	MLT, SLT 0 ~ 9, *, # Maximum of eight digits	634		✓	
11-14-09	<b>Service Code Setup (for Hotel) – Set Room to Room Call Restriction</b> Customize the set room to room call extension used with the Hotel/Motel feature (GCD-CP10 must be licensed for Hotel/Motel).	MLT, SLT 0 ~ 9, *, # Maximum of eight digits	635		✓	

Program Number	Program Name/Description	Input Data	Default	Level		
				1	2	3
11-14-10	<b>Service Code Setup (for Hotel) –Cancel Room to Room Call Restriction (Hotel)</b> Customize the cancel room to room call restriction (hotel) used with the Hotel/Motel feature (GCD-CP10 must be licensed for Hotel/Motel).	MLT, SLT 0 ~ 9, *, # Maximum of eight digits	636		✓	
11-14-11	<b>Service Code Setup (for Hotel) – Change Toll Restriction Class for Other Extension</b> Customize the change toll restriction class for other extension used with the Hotel/Motel feature (GCD-CP10 must be licensed for Hotel/Motel).	MLT, SLT 0 ~ 9, *, # Maximum of eight digits	637		✓	
11-14-12	<b>Service Code Setup (for Hotel) – Check-In</b> Customize the check-in Service Codes which are used with the Hotel/Motel feature.	MLT, SLT 0 ~ 9, *, # Maximum of eight digits	638		✓	
11-14-13	<b>Service Code Setup (for Hotel) – Check-Out</b> Customize the check-out Service Codes used with the Hotel/Motel feature (GCD-CP10 must be licensed for Hotel/Motel).	MLT, SLT 0 ~ 9, *, # Maximum of eight digits	639		✓	
11-14-14	<b>Service Code Setup (for Hotel) – Room Status Change for Own Extension</b> Customize the room status change for own extension Service Codes used with the Hotel/Motel feature (GCD-CP10 must be licensed for Hotel/Motel).	MLT, SLT 0 ~ 9, *, # Maximum of eight digits	640		✓	
11-14-15	<b>Service Code Setup (for Hotel) – Room Status Change for Other Extension</b> Customize the room status change for other extension Service Codes which are used with the Hotel/Motel feature (GCD-CP10 must be licensed for Hotel/Motel).	MLT, SLT 0 ~ 9, *, # Maximum of eight digits	641		✓	
11-14-16	<b>Service Code Setup (for Hotel) – Room Status Output</b> Customize the room status output Service Codes used with the Hotel/Motel feature (GCD-CP10 must be licensed for Hotel/Motel).	MLT 0 ~ 9, *, # Maximum of eight digits	642		✓	
11-14-17	<b>Service Code Setup (for Hotel) – Hotel Room Monitor</b> Customize the hotel room monitor Service Codes used with the Hotel/Motel feature (GCD-CP10 must be licensed for Hotel/Motel).	MLT, SLT 0 ~ 9, *, # Maximum of eight digits	675		✓	
11-14-18	<b>Service Code Setup (for Hotel) – Set Hotel PMS Code Restriction</b> Customize the set hotel PMS code restriction Service Codes used with the Hotel/Motel feature (GCD-CP10 must be licensed for Hotel/Motel).	MLT 0 ~ 9, *, # Maximum of eight digits	666		✓	



Program Number	Program Name/Description	Input Data	Default	Level		
				1	2	3
15-03-01	<p><b>Single Line Telephone Basic Data Setup – SLT Signaling Type</b></p> <p>Select the type of dialing the connected telephone uses.</p> <p>For the UNIVERGE SV9100 Wireless telephones to function correctly, this must be set to 0. If this option is set for DTMF, after an outside call is placed, the system cannot dial any additional digit.</p> <p>This program change is automatically performed when the UNIVERGE SV9100 Wireless telephone is registered. When upgrading software from prior versions, the previous default of 1 is saved from the prior database so this option must be changed manually.</p>	<p>0 = DP 1 = DTMF</p>	1		✓	
15-03-04	<p><b>Single Line Telephone Basic Data Setup – Flashing</b></p> <p>Enable/Disable Flash for single line (500/2500 type) telephones.</p>	<p>0 = No 1 = Yes</p>	1		✓	
20-06-01	<p><b>Class of Service for Extensions</b></p> <p>Assign a Class of Service (1 ~ 15) to extensions.</p>	<p>Day Night/Mode: 1 ~ 8 Class of Service of Extensions (1 ~ 15)</p>	<p>Extension port 101 = Class 15 All other extension port = Class 1</p>	✓		
20-13-11	<p><b>Class of Service Options (Supplementary Service) – Room Monitor, Initiating Extension</b></p> <p>Turn Off or On an extension user ability to Room Monitor other extensions.</p>	<p>0 = Off 1 = On</p>	COS 1 ~ 15 = 0			✓
20-13-13	<p><b>Class of Service Options (Supplementary Service) – Continued Dialing (DTMF) Signal on ICM Call</b></p> <p>Turn Off or On an extension user ability to use Continued Dialing, which allows DTMF signal sending while talking on extension.</p>	<p>0 = Off 1 = On</p>	COS 1 ~ 15 = 1		✓	
20-13-16	<p><b>Class of Service Options (Supplementary Service) – Barge-In, Receive</b></p> <p>Turn Off or On Barge-In at the receiving extension (i.e., Barge-In receive).</p>	<p>0 = Off 1 = On</p>	COS 1 ~ 15 = 0			✓
20-13-17	<p><b>Class of Service Options (Supplementary Service) – Barge-In Tone/Display (Intrusion Tone)</b></p> <p>Turn Off or On the Barge-In (Intrusion) Tone. If disabled, this also turns off the Barge-In display at the called extension.</p>	<p>0 = Off 1 = On</p>	COS 1 ~ 15 = 1			✓
20-13-40	<p><b>Class of Service Options (Supplementary Service) – Do Not Disturb</b></p> <p>Turn Off or On an extension user ability to set or cancel Do Not Disturb.</p>	<p>0 = Off 1 = On</p>	COS 1 ~ 15 = 1			✓

Program Number	Program Name/Description	Input Data	Default	Level		
				1	2	3
20-15-10	<b>Ring Cycle Setup – Alarm for SLT</b> Define the ring cycle for Alarm for SLT terminals.	Ringing Cycle = 1 ~ 13	5		✓	
20-17-01	<b>Operator Extension – Operator’s Extension Number</b> Define the extension numbers used by operators.	Maximum of eight digits	101		✓	
20-35-01	<b>Extension’s Operator Setting</b> Assign an extension to an operator group.	0 ~ 15	0			✓
30-01-01	<b>DSS Console Operating Mode</b> Set the mode of the system DSS Consoles. This option applies to all system DSS Consoles.	0 = Business Mode 1 = Hotel Mode 2 = Monitor Mode 3 = Business/ Mode	0	✓		
30-02-01	<b>DSS Console Extension Assignment – Extension Number</b> Define the extension number for the multiline terminal connected with the DSS console (up to eight digits).	Maximum of eight digits	No Setting		✓	
30-03-01	<b>DSS Console Key Assignment</b> Customize DSS Console keys to function as DSS keys, Service Code keys, Programmable Function Keys, and One-Touch Calling keys. The key [when defined as a DSS/One-Touch key (code 01)] can have any function up to four digits (e.g., extension number or Service Code). The function information (such as extension number or Service Code) would then be entered as the additional data.	Key Number 001 ~ 114 0 ~ 99 (General Functional Level) 97 = Door Box Access key (additional data: 1 ~ 8 Door Box No.) * 00 ~ * 99 (Appearance Functional Level)	Refer to the Programming Manual for default values.	✓		
42-01-01	<b>System Options for Hotel/Motel – Answering Message Mode for Wake Up Call (Hotel Mode)</b> Assign the answering message mode for wake up call options for Hotel/Motel Service.	0 = MOH (Hold Time) 1 = VRS Message 2 = VRS Message + Time	0		✓	
42-01-02	<b>System Options for Hotel/Motel – Wake Up Call Message Assignment</b> VRS Message for Wake Up Calls. You must make an entry for this program if you have selected 1 or 2 in Item 1 above.	0 ~ 100 (0 = No Setting)	0		✓	
42-01-03	<b>System Options for Hotel/Motel – Wake Up Call No Answer</b> Assign the wake up call no answer options for Hotel/Motel Service.	0 = No Transfer 1 = Transfer to the Operator	0		✓	
42-01-04	<b>System Options for Hotel/Motel – Setup Message Mode for Wake Up Call (Hotel Mode)</b> Assign the setup message mode for wake up call (hotel mode) options for Hotel/Motel Service.	0 = Fixed Message 1 = VRS Message 2 = Time Information and VRS	0		✓	

Program Number	Program Name/Description	Input Data	Default	Level		
				1	2	3
42-01-05	<b>System Options for Hotel/Motel – Wake Up Call Message Assignment</b> Assign the wake up call message assignment options for Hotel/Motel Service.	0 ~ 100 (0 = No Setting)	0		✓	
42-01-06	<b>System Options for Hotel/Motel – Flexible Room Status</b> Use this option to enable (1) or disable (0) for the system to change from any status code to any other status code. Refer to <a href="#">Table 2-36 Valid Room Status Changes when Program 42-01-06 is set to 0 (Disabled) on page 2-624</a> above and in the PMS Developer Guide for valid status code changes when this program is disabled.	0 = Disabled 1 = Enabled	0	✓		
42-01-07	<b>System Options for Hotel/Motel – Snooze Callback Timer</b> Assign the number of minutes before a Snooze Callback is performed.	0 = Not Activated 1 = (1 ~ 30) Minutes	10		✓	
42-01-08	<b>System Options for Hotel/Motel – Snooze Callback Setting Dial</b> Snooze Callback Setting Dial Assign the digit dialed by user to set Snooze Callback.	0 ~ 9, *, # (Up to one digit)	1		✓	
42-02-01	<b>Hotel/Motel Telephone Setup – Hotel Mode</b> If you want an extension to operate in the Hotel/Motel mode, enter 1. If you want the telephone to operate in the business mode, enter 0.	0 = Normal 1 = Hotel	0	✓		
42-02-02	<b>Hotel/Motel Telephone Setup – Toll Restriction Class When Check In</b> Assign an extension Toll Restriction Class when it is checked in. The system has 15 Toll Restriction Classes (1 ~ 15). The entry you make in this option affects the telephone in all Night Service modes. (Refer to Programs 21-05 and 21-06 to set up the Toll Restriction dialing options.) When the extension is checked out, it uses the Toll Restriction Class set in Program 21-04.	1 ~ 15	1		✓	
42-02-03	<b>Hotel/Motel Telephone Setup – Room Status</b> This is a read only program that shows the current room status setting.	1 = Room Clean (Occupied) 2 = Maid Required 3 = Maid in Room 4 = Inspection Required 5 = Maintenance Request 6 = Out of Order 7 = Reserve 1 8 = Reserve 2 9 = Reserve 3 0 = Room Clean (Vacant) * = Reserve 5 # = Reserve 6	No Setting			✓

Program Number	Program Name/Description	Input Data	Default	Level		
				1	2	3
42-03-01	<b>Class of Service Options (Hotel/Motel) – Check-In Operation</b> Set the Hotel/Motel check-in operation COS options.	0 = Off 1 = On	COS 1 ~ 15 = 0	✓		
42-03-02	<b>Class of Service Options (Hotel/Motel) – Check-Out Operation</b> Set the Hotel/Motel check-out operation COS options.	0 = Off 1 = On	COS 1 ~ 15 = 0	✓		
42-03-03	<b>Class of Service Options (Hotel/Motel) – Room Status Output</b> Set the Hotel/Motel room status output COS options.	0 = Off 1 = On	COS 1 ~ 15 = 0	✓		
42-03-04	<b>Class of Service Options (Hotel/Motel) – DND Setting for Other Extension</b> Set the Hotel/Motel DND setting for other extension COS options.	0 = Off 1 = On	COS 1 ~ 15 = 0	✓		
42-03-05	<b>Class of Service Options (Hotel/Motel) – Wake up Call Setting for Other Extension</b> Set the Hotel/Motel wake up call setting for other extension COS options.	0 = Off 1 = On	COS 1 ~ 15 = 0	✓		
42-03-06	<b>Class of Service Options (Hotel/Motel) – Room Status Change for Other Extension</b> Set the Hotel/Motel room status change for other extension COS options.	0 = Off 1 = On	COS 1 ~ 15 = 0	✓		
42-03-07	<b>Class of Service Options (Hotel/Motel) – Restriction Class Changing for Other Extension</b> Set the Hotel/Motel restriction class changing for other extension COS options.	0 = Off 1 = On	COS 1 ~ 15 = 0	✓		
42-03-08	<b>Class of Service Options (Hotel/Motel) – Room to Room Call Restriction</b> Set the Hotel/Motel room to room call restriction COS options.	0 = Off 1 = On	COS 1 ~ 15 = 0	✓		
42-03-09	<b>Class of Service Options (Hotel/Motel) – DND Setting for Own Extension</b> Set the Hotel/Motel DND setting for own extension COS options.	0 = Off 1 = On	COS 1 ~ 15 = 0	✓		
42-03-10	<b>Class of Service Options (Hotel/Motel) – Wake Up Call Setting for Own Extension</b> Set the Hotel/Motel wake up call setting for own extension COS options.	0 = Off 1 = On	COS 1 ~ 15 = 0	✓		
42-03-11	<b>Class of Service Options (Hotel/Motel) – Change Room Status for Own Extension</b> Set the Hotel/Motel change room status for own extension COS options.	0 = Off 1 = On	COS 1 ~ 15 = 0	✓		

Program Number	Program Name/Description	Input Data	Default	Level		
				1	2	3
42-03-12	<b>Class of Service Options (Hotel/Motel) – SLT Room Monitor</b> Enable/Disable a single line telephone ability to use Room Monitor.	0 = Off 1 = On	COS 1 ~ 15 = 0	✓		
42-03-13	<b>Class of Service Options (Hotel/Motel) – PMS Restriction Level</b> Enable/Disable the attendant's ability to change the outgoing restriction class for hotel phones.	0 = Off 1 = On	COS 1 ~ 15 = 0	✓		
42-04-01	<b>Hotel Mode One-Digit Service Codes</b> Set up the Hotel Mode one-digit service codes assigned in Program 42-02-01.	1 ~ 64 (Calling Group) Maximum of eight digits 1 ~ 9, 0, *, #	No Setting			✓
42-05-01	<b>Hotel Room Status Printer – Output Port Type</b> Set the LAN port to output the Hotel Data (Check-Out sheet, Room Status, etc.) and the output port type options for the Hotel/ Motel feature.	0 = No Setting 1 = Not Used 3 = LAN	0			✓
42-05-03	<b>Hotel Room Status Printer – Wake Up Call No Answer Data</b> Set the LAN port to output the Hotel Data (Check-Out sheet, Room Status, etc.) and the wake up call no answer data options for the Hotel/ Motel feature.	0 = Not Output 1 = Output	0			✓
42-05-04	<b>Hotel Room Status Printer – Check-Out Sheet</b> Set the LAN port to output the Hotel Data (Check-Out sheet, Room Status, etc.) and the check-out sheet options for the Hotel/ Motel feature.	0 = Not Output 1 = Output	0			✓
42-06-01	<b>PMS Service Setting – PMS Port Number</b> Set the PMS port number when using the PMS feature.	0 ~ 65535	5129			✓
42-06-02	<b>PMS Service Setting – 3:00 AM Auto Room Scan</b> Set maid required status for all checked-in rooms at 3:00 AM.	0 = Off 1 = On	0			✓
42-06-03	<b>PMS Service Setting – CheckIn Message Type</b> Used to enable PMS integration.	0 = Off 1 = On	0	✓		
42-06-04	<b>PMS Service Setting – CheckOut Auto Status Change</b> Set the checkout auto status change when using the PMS feature.	0 = Off 1 = On	0			✓
42-06-05	<b>PMS Service Setting – AREYUTHERE/LINETEST Send Timing</b> Set the AREYUTHERE/LINETEST send timing when using the PMS feature.	1 ~ 128 (seconds)	10			✓

Program Number	Program Name/Description	Input Data	Default	Level		
				1	2	3
42-06-06	<b>PMS Service Setting – AREYUTHERE/LINETEST Send Count</b> Set the AREYUTHERE/LINETEST send count when using the PMS feature.	0 ~ 20 (times)	3			✓
42-06-07	<b>PMS Service Setting – Check-Out Auto Flexible Status Change</b> When Programs 42-06-07 and 42-06-04 are both enabled, the status programmed in Program 42-06-08 is set upon checkout regardless of the previous room status.	0 = Disabled 1 = Enabled	0		✓	
42-06-08	<b>PMS Service Setting – Status for Check-Out Auto Flexible Status Change</b> When Program 42-06-07 is enabled the status programmed in 42-06-08 is set upon checkout.	1 = Room Clean (Occupied) 2 = Maid Required 3 = Maid in Room 4 = Inspection Required 5 = Maintenance Request 6 = Out of Order 7 = Reserve 1 8 = Reserve 2 9 = Reserve 3 0 = Room Clean (Vacant) * = Reserve 5 # = Reserve 6	4		✓	
42-07-01	<b>PMS Restriction Level Conversion Table</b> Change the default Toll Restriction class on check in for a room (Program 42-02-02).	1 ~ 15	Level 0 = 10 Level 1 = 11 Level 2 = 12 Level 3 = 13		✓	
42-09-01	<b>Flexible Setup for Room Status</b> When Program 42-01-06 is enabled dial room status codes can be defined in this program. Note the code definitions only apply to the system itself, when sending room status messages to the PMS Application the status codes are always sent as defined in the PMS Developer Guide.	1 = Room Clean (Occupied) 2 = Maid Required 3 = Maid in Room 4 = Inspection Required 5 = Maintenance Request 6 = Out of Order 7 = Reserve 1 8 = Reserve 2 9 = Reserve 3 0 = Room Clean (Vacant) * = Reserve 5 # = Reserve 6	No Setting		✓	
84-34-01	<b>VoIPDB DTMF Setup – DTFMF Relay Mode</b> When using Standard SIP phones as room phones, the DTMF Relay Mode for Type 4 SIP Extension must be defined as RFC2833.	0 = Disable 1 = RFC2833 2 = H.245	0		✓	
84-34-02	<b>VoIPDB DTMF Setup – DTMF Payload Number</b> When using Standard SIP phones as room phones, the DTMF Payload used by the Standard SIP extensions must be defined.	96 ~ 127	110		✓	

## Operation



— *Refer to the UNIVERGE SV9100 Hotel/Motel Services Manual for complete operation information*

## Description

Hotline gives a multiline terminal user one-button calling and Transfer to another extension (the Hotline partner). Hotline helps co-workers that work closely together. The Hotline partners can call or Transfer calls to each other just by pressing a single key.

Hotline has two applications.

- Hotline (Hotline partner)
- Ringdown Extension, Internal/External (Refer to [Ringdown Extension, Internal/External on page 2-1367.](#))

In addition, the Hotline key shows the status of the partner’s extension.

When the key is . . .	The extension is . . .
Off	Idle
On	Busy or ringing
Fast Flash	DND – All calls (option 3) or Intercom calls (option 2)
Double Wink On	Agent logged onto the group
Wink Off	Agent logged off

There are 960 internal Hotline extensions available.

## Conditions

- An extension user cannot use Hotline to pick up a call ringing their partner’s extension.
- If a station is a agent, the Hotline key blinks to indicate the agent’s status.
- Hotline keys can be assigned to the DSS consoles.
- Hotline does not override Do Not Disturb.
- Hotline always follows the Handsfree Answerback/Forced Intercom Ringing mode set at the called extension. The Hotline caller can override the setting, if desired.
- External Hotline automatically dials a telephone number or Speed Dial - System/Group/ Station number when the handset is lifted.
- If the partner’s extension is busy, Hotline does not automatically activate Off-Hook Signaling.
- A Hotline is a uniquely programmed function key.



## Default Setting

Disabled

## Related Features

- ↳ [Contact Center](#)
- ↳ [Direct Station Selection \(DSS\) Console](#)
- ↳ [Distinctive Ringing, Tones and Flash Patterns](#)
- ↳ [Do Not Disturb](#)
- ↳ [Handsfree Answerback/Forced Intercom Ringing](#)
- ↳ [Off-Hook Signaling](#)
- ↳ [Programmable Function Keys](#)
- ↳ [Ringdown Extension, Internal/External](#)

## Guide to Feature Programming

The **Level 1**, **Level 2** and **Level 3** columns indicate the programs that are assigned when programming this feature in the order they are most commonly used. These levels are used with PCPro and WebPro wizards for feature programming.

- Level 1 – these are the most commonly assigned programs for this feature.
- Level 2 – these are the next most commonly assigned programs for this feature.
- Level 3 – these programs are not often assigned and require an expert level working knowledge of the system to be properly assigned.

Program Number	Program Name/Description	Input Data	Default	Level		
				1	2	3
15-07-01	<b>Programmable Function Keys</b> Assign a function key for Hotline (code 01 + partner's extension number).	Line Key 1 ~ 48 0 ~ 99 (Normal Function Code 751 by default) *00 ~ *99 (Appearance Function Code) (Service Code 752 by default)	Refer to the Programming Manual for default values.	✓		

Program Number	Program Name/Description	Input Data	Default	Level		
				1	2	3
15-02-22	<p><b>Multiline Telephone Basic Data Setup – Multiple Incoming From Intercom and Trunk</b></p> <p>When this option is Disabled, incoming calls to an extension indicate on any Hotline key for that extension as solid (busy). When this option is Enabled, lighting is determined by the setting of Program 22-01-01 Incoming Call Priority. If set to trunk (1), the Hotline key lights solid when a trunk call rings in. If set to intercom (0), the Hotline key does not light for incoming trunk calls, but lights solid for intercom calls.</p>	0 = Disable 1 = Enable	1		✓	
20-06-01	<p><b>Class of Service for Extensions</b></p> <p>Assign a Class of Service to extensions (1 ~ 15).</p>	Day Night/Mode: 1 ~ 8 Class of Service of Extensions (1 ~ 15)	Extension port 101 = Class 15 All other extension port = Class 1		✓	
20-08-09	<p><b>Class of Service Options (Outgoing Call Service) – Hotline/Extension Ringdown</b></p> <p>Turn Off or On Hotline (Ringdown). If disabled in COS, the settings in Program 21-11 below have no effect.</p>	0 = Off 1 = On	COS 1 ~ 15 = 0		✓	
20-08-19	<p><b>Class of Service Options (Outgoing Call Service) – Hotline for SPK</b></p> <p>Turn Off or On an extension user ability to press Speaker to activate hotline or ringdown.</p>	0 = Off 1 = On	COS 1 ~ 15 = 0		✓	
20-11-06	<p><b>Class of Service Options (Hold/Transfer Service) – Unscreened Transfer (Ring Inward Transfer)</b></p> <p>Turn Off or On an extension user ability to use Unscreened Transfer.</p>	0 = Off 1 = On	COS 1 ~ 15 = 1		✓	
20-11-11	<p><b>Class of Service Options (Hold/Transfer Service) – Automatic On-Hook Transfer</b></p> <p>Turn Off or On an extension user ability to use Automatic On-Hook Transfer.</p>	0 = Off 1 = On	COS 1 ~ 15 = 0		✓	
20-13-06	<p><b>Class of Service Options (Supplementary Service) – Automatic Off-Hook Signaling (Automatic Override)</b></p> <p>Program 20-02-03 and Program 20-13-06 set the conditions under which a Hotline, Reverse Voice Over or DSS Console key indicates that an extension is busy. With condition 1 in the following chart, the BLF LED is on only when both extension line appearances are busy. In conditions 2 ~ 4, the BLF LED is on when one line appearance is busy.</p>	0 = Off 1 = On	COS 1 ~ 15 = 1  Refer to <a href="#">Table 2-37 Extension Busy Setup on page 2-641</a> .		✓	
21-01-09	<p><b>System Options for Outgoing Calls – Ringdown Extension Timer (Hotline Start)</b></p> <p>A Ringdown extension automatically calls its programmed destination after this time.</p>	0 ~ 64800 seconds	5 seconds		✓	

Program Number	Program Name/Description	Input Data	Default	Level		
				1	2	3
21-11-01	<p><b>Extension Ringdown (Hotline) Assignment</b>                      Define the Hotline destination number for each extension number.                      Program the ringdown (Hotline) source and destination (target) number, up to 24 digits (960 Hotline assignments). Include the trunk access code (usually 9) in front of the number when dialing outside numbers.                      When programming Speed Dial – System numbers as the destination, the entry should be #2 + bin number (the service code for Speed Dialing and the Speed Dial bin number).</p>	0, *, #, Pause, Hook Flash, @ Maximum of 24 digits (Code to wait for answer supervision)	No Setting		✓	
22-01-01	<p><b>System Options for Incoming Calls – Incoming Call Priority</b>                      Determine if Intercom calls or trunk calls have answer priority when both are ringing simultaneously.</p>	0 = Intercom call priority 1 = Trunk call priority	1		✓	
30-05-02	<p><b>DSS Console Lamp Table – Busy Extension</b>                      Define the LED patterns for busy extensions on the DSS consoles.</p>	0 ~ 7	7 (On)		✓	
30-05-03	<p><b>DSS Console Lamp Table – DND Extension</b>                      Define the LED patterns for DND extensions on the DSS consoles.</p>	0 ~ 7	3 (RW)		✓	
30-05-04	<p><b>DSS Console Lamp Table – Agent Busy</b>                      Define the LED patterns for busy agents function on the DSS consoles.</p>	0 ~ 7	7 (On)		✓	
30-05-05	<p><b>DSS Console Lamp Table – Out of Schedule (DSS)</b>                      Define the LED patterns for out of schedule (/ DSS) on the DSS consoles.</p>	0 ~ 7	0 (Off)		✓	
30-05-06	<p><b>DSS Console Lamp Table – Agent Log Out (DSS)</b>                      Define the LED patterns for agents that are logged out on the DSS consoles.</p>	0 ~ 7	5 (IL)		✓	
30-05-07	<p><b>DSS Console Lamp Table – Agent Log In (DSS)</b>                      Define the LED patterns for agents that are logged in the DSS consoles.</p>	0 ~ 7	4 (IR)		✓	
30-05-08	<p><b>DSS Console Lamp Table – Agent Emergency (DSS)</b>                      Define the LED patterns for agents in emergency on the DSS consoles.</p>	0 ~ 7	6 (IW)		✓	
30-05-09	<p><b>DSS Console Lamp Table – Hotel Status Code 1 (Hotel DSS)</b>                      Define the LED patterns for hotel status code 1 on the DSS consoles.</p>	0 ~ 7	7 (On)		✓	

Program Number	Program Name/Description	Input Data	Default	Level		
				1	2	3
30-05-10	<b>DSS Console Lamp Table – Hotel Status Code 2 (Hotel DSS)</b> Define the LED patterns for hotel status code 2 on the DSS consoles.	0 ~ 7	1 (FL)		✓	
30-05-11	<b>DSS Console Lamp Table – Hotel Status Code 3 (Hotel DSS)</b> Define the LED patterns for hotel status code 3 on the DSS consoles.	0 ~ 7	2 (WK)		✓	
30-05-12	<b>DSS Console Lamp Table – Hotel Status Code 4 (Hotel DSS)</b> Define the LED patterns for hotel status code 4 on the DSS consoles.	0 ~ 7	3 (RW)		✓	
30-05-13	<b>DSS Console Lamp Table – Hotel Status Code 5 (Hotel DSS)</b> Define the LED patterns for hotel status code 5 on the DSS consoles.	0 ~ 7	5 (IL)		✓	
30-05-14	<b>DSS Console Lamp Table – Hotel Status Code 6 (Hotel DSS)</b> Define the LED patterns for hotel status code 6 on the DSS consoles.	0 ~ 7	3 (RW)		✓	
30-05-15	<b>DSS Console Lamp Table – Hotel Status Code 7 (Hotel DSS)</b> Define the LED patterns for hotel status code 7 on the DSS consoles.	0 ~ 7	6 (IW)		✓	
30-05-16	<b>DSS Console Lamp Table – Hotel Status Code 8 (Hotel DSS)</b> Define the LED patterns for hotel status code 8 on the DSS consoles.	0 ~ 7	4 (IR)		✓	
30-05-17	<b>DSS Console Lamp Table – Hotel Status Code 9 (Hotel DSS)</b> Define the LED patterns for hotel status code 9 on the DSS consoles.	0 ~ 7	3 (RW)		✓	
30-05-18	<b>DSS Console Lamp Table – Hotel Status Code 0 (Hotel DSS)</b> Define the LED patterns for hotel status code 0 on the DSS consoles.	0 ~ 7	0 (Off)		✓	
30-05-19	<b>DSS Console Lamp Table – Hotel Status Code * (Hotel DSS)</b> Define the LED patterns for hotel status code * on the DSS consoles.	0 ~ 7	4 (IR)		✓	
30-05-20	<b>DSS Console Lamp Table – Hotel Status Code # (Hotel DSS)</b> Define the LED patterns for hotel status code # on the DSS consoles.	0 ~ 7	5 (IL)		✓	

Program Number	Program Name/Description	Input Data	Default	Level		
				1	2	3
30-05-21	<b>DSS Console Lamp Table – VM Message Indication</b> Define the LED patterns for VM message indication on the DSS consoles.	0 ~ 7	3 (RW)		✓	

Table 2-37 Extension Busy Setup

	Program 20-13-06	Program 20-02-03	BLF <sup>1</sup> Status	Busy Status
1	1	0	Off	No
2	1	1	On	Yes
3	0	0	On	Yes
4	0	1	On	Yes

<sup>1</sup> BLF is on for extension receiving a voice announced Intercom call.

## Operation

### To place a call to your Hotline partner:

1. Press the **Hotline** key (Program 15-07 or SC 751: 01 + partner’s extension number).  
 ◇ *You can optionally lift the handset after this step for privacy.*

### To transfer your outside call to your Hotline partner:

1. Press the **Hotline** key.
2. Announce the call and hang up.

- OR -

Hang up to have the call wait at your Hotline partner unannounced.

◇ *If unanswered, the call recalls like a regular transferred call.*

### To answer a call from your Hotline partner:

1. If you hear two beeps, speak toward the telephone.

- OR -

If your telephone rings, lift the handset.

## Hot Key-Pad

### Description

The Hot Key-Pad feature allows the user to place a call without lifting the handset or pressing Speaker. When the user dials another extension number on an idle telephone with Hot Key-Pad enabled, the Speaker lights and the internal call is made. When the user dials the trunk access code from a telephone with Hot Key-Pad enabled, Speaker lights, a trunk is seized and the outgoing call is made.

### Conditions

- When a user dials any digit on a station with Hot Key-Pad enabled, Speaker LED lights.
- After a user dials the trunk access code on a station with Hot Key-Pad enabled, a trunk is seized when dialing the first digit of the called party number.
- When both Hot Key-Pad and Dialing Number Preview are turned on, Hot Key-Pad has priority and Dialing Number Preview does not work.
- When both Hot Key-Pad and Hotline are turned on, Hot Key-Pad has priority and Hotline does not work.
- When placing an outgoing call with the Hot Key-Pad feature, the user must dial the trunk access code before dialing the called party number.
- The ARS feature can be used when placing outside calls with the Hot Key-Pad feature.
- When both Hot Key-Pad and VRS Fixed Messaging are turned on, VRS fixed messaging does not work.
- The Hot Key-Pad Feature also works when dialing service codes.

### Default Settings

Disabled

### System Availability

#### Terminals

All Multiline Terminals

#### Required Software

None

## Related Features

- ↳ [Central Office Calls, Placing](#)
- ↳ [Class of Service](#)
- ↳ [Dialing Number Preview](#)
- ↳ [Hotline](#)
- ↳ [Intercom](#)
- ↳ [Voice Response System \(VRS\)](#)

## Guide to Feature Programming

The **Level 1**, **Level 2** and **Level 3** columns indicate the programs that are assigned when programming this feature in the order they are most commonly used. These levels are used with PCPro and WebPro wizards for feature programming.

- Level 1 – these are the most commonly assigned programs for this feature.
- Level 2 – these are the next most commonly assigned programs for this feature.
- Level 3 – these programs are not often assigned and require an expert level working knowledge of the system to be properly assigned.

Program Number	Program Name/Description	Input Data	Default	Level		
				1	2	3
20-06-01	<b>Class of Service for Extensions</b> Assign a Class of Service to extensions (1 ~ 15). Any Class of Service assignments you change using Service Code 677 automatically update this program.	Day Night/Mode: 1 ~ 8 Class of Service of Extensions (1 ~ 15)	Extension port 101 = Class 15 All other extension port = Class 1		✓	
20-08-20	<b>Class of Service Options (Outgoing Call Service) – Hot Key Pad</b> Turn Off or On an extension user ability to make a call by dialing the number without going off-hook.	0 = Off 1 = On	COS 1 ~ 15 = 0	✓		

## Operation

### To place an intercom call using Hot Key-Pad:

1. The multiline terminal is idle. There is no need to press Speaker.
2. Dial the extension.
3. Dialed extension rings.

### To place a trunk call using Hot Key-Pad:

1. The multiline terminal is idle. There is no need to press Speaker.
2. Dial the trunk access code, **9** by default, and the external destination number you want to call.



## Howler Tone Service

### Description

Howler Tone Service provides a Howler Tone when a station remains off-hook after a call is completed or when a station is off-hook and digits are not dialed in a programmed time.

#### Conditions

Howler tone is generated 45 seconds after a call is disconnected and the telephone is left off-hook or the telephone is left off-hook without dialing.

#### Default Settings

Enabled

### System Availability

#### Terminals

All Terminals

#### Required Component(s)

None

### Related Features

None

### Guide to Feature Programming

The **Level 1**, **Level 2** and **Level 3** columns indicate the programs that are assigned when programming this feature in the order they are most commonly used. These levels are used with PCPro and WebPro wizards for feature programming.

- Level 1 – these are the most commonly assigned programs for this feature.
- Level 2 – these are the next most commonly assigned programs for this feature.
- Level 3 – these programs are not often assigned and require an expert level working knowledge of the system to be properly assigned.

Program Number	Program Name/Description	Input Data	Default	Level		
				1	2	3
20-18-01	<b>Service Tone Timers – Extension Dial Tone Time</b> After completion of dial tone time Intercom dial tone, a telephone user has this time to dial the first digit of the Intercom call.	0 ~ 64800 seconds	30		✓	
20-18-02	<b>Service Tone Timers – Busy Tone Timer</b> After Program 20-18-01 expires Busy Tone will play for time programmed in this memory block.	0 ~ 64800 seconds	15		✓	
80-01-01	<b>Service Tone Setup – Repeat Count</b> Customize the system basic tones and system service tones. The system must be reset for the changes to take affect.	0 ~ 255 (0 = until On-Hook)	Refer to <a href="#">Table 2-33 Service Tone Setup Defaults, Program 80-01-01</a> on page 2-594.		✓	
80-01-02	<b>Service Tone Setup – Basic Tone Number</b> The following features require that the system tones listed below be changed to match the table. After changing these settings the system must be reset for the changes to take effect. <ul style="list-style-type: none"> <li>○ Call Screening</li> <li>○ Call Holding</li> <li>○ Busy Greeting</li> <li>○ Await Answer Transfer</li> </ul>	1 ~ 33 0 = No Tone 33 = Default Time Slot	Refer to the Programming Manual for default values.		✓	

## Operation

None

### Description

The InControl Call Reporting is a browser-based series of reports that generate sought after business analytics to help management make better business decisions. Three types of reports are available; Detailed, Summary and Other. After the user successfully logs in, all reports are displayed on the opening page.

- Detailed Reports
  - Extension Call Details
  - Phone Number Details (Cradle to grave)
- Summary Reports
  - Department Call Summary
  - Extension Summary by Department
  - Extension Call Summary
- Other Reports
  - Trunk Utilization

The InControl Call Reporting database can hold approximately 2 million calls for every GB of disk storage space.

Summary reports provide the ability to retrieve detailed information in a report. Clicking a hyperlink within a summary report drills down to the next report. Each report can be set to **Run Once** or **Run on a Schedule**. Run on a Schedule allows the user to pick start and stop times, PDF or CSV format, and an Email address to send it to. Email send settings are made in Program 47-18. The Print Page button opens a print dialog allowing the user to select a preferred printer to print the report to.

### Templates

Templates are saved reports, less the data, that can be re-run, duplicated or edited. Templates are separated into two categories; Once-only and Scheduled. Any report that has been run is saved as a template to facilitate re-running the same or a modified report.

### Archived Reports

Archived reports are copies of a scheduled report that has been previously run. These reports contain report data and can be downloaded in the event the original report is deleted.

### Conditions

- InControl Call Reporting users log in using a UC Suite login defined in Program 20-59.
- Departments for reports are defined in the UC Suite directory.
- Email send settings for Emailing reports are defined in Program 47-18.

### Default Settings

The URL for InControl Call Reporting is `http://{IP address of the UC Suite/Contact Center server}/reports`. An example would be: `http://192.168.1.10/reports`

## System Availability

### Terminals

All Terminals

### Required Component(s)

- Contact Center 1.6 (Software only, Contact Center licenses not required.)
- UC Suite 4.0 (Software only, UC Suite licenses not required.)
- InControl Call Reporting is supported on the following Internet Browsers:
  - Internet Explorer 11
  - Mozilla Firefox 44
  - Chrome 48
- 2107 – SV9100 InControl CR PKG Lic
- 2101 – SV9100 Contact Center P-Event Lic
- 5327 – SV9100 InControl AddOn Lic

### Related Features

None

## Guide to Feature Programming

The **Level 1**, **Level 2** and **Level 3** columns indicate the programs that are assigned when programming this feature in the order they are most commonly used. These levels are used with PCPro and WebPro wizards for feature programming.

- Level 1 – these are the most commonly assigned programs for this feature.
- Level 2 – these are the next most commonly assigned programs for this feature.
- Level 3 – these programs are not often assigned and require an expert level working knowledge of the system to be properly assigned.

Program Number	Program Name/Description	Input Data	Default	Level		
				1	2	3
10-12-03	<b>GCD-CP10 Network Setup – Default Gateway</b> Define the default gateway to be used by the GPZ-IPLE interface.	0.0.0.0 ~ 126.255.255.254 128.0.0.1 ~ 191.255.255.254 192.0.0.1 ~ 223.255.255.254	0.0.0.0	✓		
10-12-09	<b>GCD-CP10 Network Setup – IP Address</b> Set IP address for GPZ-IPLE.	0.0.0.0 ~ 126.255.255.254 128.0.0.1 ~ 191.255.255.254 192.0.0.1 ~ 223.255.255.25	172.16.0.10	✓		
10-12-10	<b>GCD-CP10 Network Setup – Subnet Mask</b> Define the Media Gateway Subnet Mask Address.	128.0.0.0   192.0.0.0   224.0.0.0  240.0.0.0   248.0.0.0   252.0.0.0  254.0.0.0   255.0.0.0  255.128.0.0   255.192.0.0  255.224.0.0   255.240.0.0  255.248.0.0   255.252.0.0  255.254.0.0   255.255.0.0  255.255.128.0   255.255.192.0  255.255.224.0   255.255.240.0  255.255.248.0   255.255.252.0  255.255.254.0   255.255.255.0  255.255.255.128  255.255.255.192  255.255.255.224  255.255.255.240  255.255.255.248  255.255.255.252  255.255.255.254  255.255.255.255	255.255.0.0		✓	

Program Number	Program Name/Description	Input Data	Default	Level		
				1	2	3
10-20-01	<b>LAN Setup for External Equipment – TCP Port</b> Define the TCP port number for the LAN CTI and O&M communication between the GCD-CP10 and the UC Suite.	0 ~ 65535	External Device 1 (CTI Server) = 0 External Device 2 (Contact Center and InControl Call Reporting) = 4000 External Device 5 (SMDR Output) = 0 External Device 6 (DIM Output) = 0 External Device 9 (1st Party CTI) = 0 External Device 11 (O&M Server) = 8010 External Device 12 (Traffic Report Output) = 0 External Device 13 (Room Data Output for Hotel Service ) = 0	✓		
10-69-01	<b>UC Server General Settings – UC Server Availability</b> Enable the UC Server if it is to be used.	0 = Disable 1 = Enable	0	✓		
10-69-02	<b>UC Server General Settings – UC Server IP Address</b> Define the IP address of the UC Server.	0.0.0.0 ~ 126.255.255.254 128.0.0.1 ~ 191.254.255.254 192.0.0.1 ~ 223.255.255.254	0.0.0.0	✓		
10-69-03	<b>UC Server General Settings – UC Server Host Name</b> Define the host name of the UC Server.	Any characters	No Setting		✓	
10-69-04	<b>UC Server General Settings – UC Server Port Number</b> Define the port UC Clients will connect to the UC Server on. Recommended port 8888.	0 ~ 65535	0	✓		
10-69-05	<b>UC Server General Settings – UC Server Trace</b> Enable if NTAC requests to turn on. This is used for troubleshooting purposes only.	0 = Disable 1 = Enable	0		✓	
10-69-06	<b>UC Server General Settings – UC Server Use Name for Communication</b> Enable if the clients will communicate with the UC Server via host name (not IP).	0 = Disable 1 = Enable	0		✓	

Program Number	Program Name/Description	Input Data	Default	Level		
				1	2	3
10-71-01	<b>UC Server MIS Settings – MIS Server IP Address</b> If the UC Server will integrate to the Contact Center Server for Abandoned Call Alerts, define the IP address of the Contact Center Server.	0.0.0.0 ~ 126.255.255.254 128.0.0.1 ~ 191.254.255.254 192.0.0.1 ~ 223.255.255.254	0.0.0.0		✓	
10-71-02	<b>UC Server MIS Settings – MIS Server Computer Name</b> If the UC Server will integrate to the Contact Center Server for Abandoned Call Alerts, define the Contact Center Server's computer name.	Any characters	No Setting		✓	
10-71-03	<b>UC Server MIS Settings – MIS Server Port Number</b> If the UC Server will integrate to the Contact Center Server for Abandoned Call Alerts, define the port number it should connect on.  ➡ <i>The Contact Center Server TCP/IP Port in Server Settings should be set to the value (port) in 10-71-03. In most cases 9090 is a suitable port.</i>	0 ~ 65535	0		✓	
20-59-01	<b>UC Server Settings – UC User ID</b> Define the user ID for the UC Suite User	Any character	No Setting	✓		
20-59-02	<b>UC Server Settings – UC User Password</b> Define the password for the UC Suite User.	Any character	No Setting	✓		
41-01-03	<b>System Options for Contact Center – Contact Center Connection Ports</b> Define what port is used for Contact Center connection. Currently only LAN is supported.	0 = None 3 = LAN (Set to LAN for InControl Call Reporting)	0	✓		

## Operation



REFERENCE

Refer to the *UNIVERGE SV9100 UC Suite Manual* for detailed feature information.

## Description

The InMail is a low cost voice mail solution that mounts on the GCD-CP10. Its programming is fully integrated with chassis programming. This system offers most voice mail system features customers expect.

Automated Attendant automatically answers the system incoming calls. After listening to a customized message, an outside caller can dial a system extension or use Voice Mail.

### Start-Up Programming (Default)

Every SV9100 has InMail built in on the system. When a system is defaulted, InMail will be automatically programmed and work in the system. The following settings are made automatically on a defaulted system. If needed, they can be changed but it is recommended that the default values be kept:

- Subscriber Mailboxes are enabled for extensions 101~164. The mailbox numbers are the same as the extension numbers.
- The Automated Attendant does not answer outside calls.
- The Department group pilot for InMail extensions in Program 11-07-01 is 3999.
- All InMail extensions are assigned to Department group 64 in Program 16-02-01.
- The extension numbers for the InMail ports are 3898-3913.
- The voice mail Department group is set to 64 in Program 45-01-01.
- InMail extensions 3898-3913 are set to DP in Program 15-03-01.
- InMail extensions 3898-3913 are set to Special in Program 15-03-03.

#### **Call Forwarding to Voice Mail**

An extension user can forward their calls to Voice Mail. Once forwarded, calls to the extension connect to that extension mailbox. The caller can leave a message in the mailbox instead of calling back later. Forwarding can occur for all calls immediately, for unanswered calls or only when the extension is busy. When a user transfers a call to an extension forwarded to Voice Mail, the call waits for the Delayed Call Forwarding time before routing to the called extension mailbox. This gives the transferring party the option of retrieving the call instead of having it go directly to the mailbox.

#### **Leaving a Message**

Voice Mail lets a multiline terminal extension user easily leave a message at an extension that is unanswered, busy or in Do Not Disturb. The caller presses their Voice Mail key to leave a message in the called extension mailbox. There is no need to call back later.



### **Transferring to Voice Mail**

By using Transfer to Voice Mail, a multiline terminal extension user can Transfer a call to the user's or a co-worker's mailbox. After the Transfer goes through, the caller can leave a message in the mailbox.

A station user transferring a call can transfer the call to the called party voice mail box after an internal station number is dialed while performing a screened transfer, or during intercom calls. The user calls the extension then dials the quick transfer dial access code (default = 8) and hangs up. The call is placed in the mailbox and the caller hears the personal greeting.

### **Live Record**

While on a CO/Trunk call, an extension user can have InMail record the conversation. The multiline terminal user just presses the InMail Record key; the ESL user dials a code. Once recorded, the Voice Messaging System stores the conversation as a new message in the user's mailbox. After calling their mailbox, a user can save, edit or delete the recorded conversation. This feature is supported only on CO, Tie, or DID calls. It is not supported on internal calls. The recording time limit is set by multiplying Program 47-01-03 x 10 with a maximum recording limit of 65 minutes. At the default (120 seconds) this will allow a 20 minute Live Recording message to be made. The initial recording beep is controlled with Program 47-02-07. The repeating beep interval is controlled with Program 45-01-06. Once Live Record is started, dialed DTMF digits are no longer sent to the outside system for the duration of that call.

### **Live Monitor**

A multiline terminal user can have their idle extension emulate a personal answering machine. This lets InMail screen their calls, just like their answering machine at home. If activated, the extension incoming calls route to the user's subscriber mailbox. The Live Monitor feature is supported for external and internal calls. After the mailbox answers, the user's phone changes to show that a caller is leaving a message, no audible tone is provided. The multiline terminal user can then:

- Choose **Exit** to let the call go through to their mailbox.
- Choose **ANSW** to intercept the call before it goes to their mailbox.
- Choose **SCRN** to monitor the message being left by the caller.

### **Personal Answering Machine Emulation**

A multiline terminal user can have their idle extension emulate a personal answering machine. This lets In-Mail screen their calls, just like their answering machine at home. If activated, the extension's incoming calls route to the user's subscriber mailbox. Once the mailbox answers, the user hears the caller's incoming message. The multiline terminal user can then:

- Let the call go through to their mailbox
- Intercept the call before it goes to their mailbox

### ❑ **Voice Mail Overflow**

If Voice Mail automatically answers trunks, Voice Mail Overflow can reroute those trunks to other extensions when all Voice Mail ports do not answer or, with certain software, are busy. During periods of high traffic, this prevents the outside calls from ringing Voice Mail for an inordinate amount of time. There are two types of Voice Mail Overflow: Immediate and Delayed. With immediate overflow, calls immediately reroute to other extensions when all Voice Mail ports do not answer or, with certain software, are busy. With delayed overflow, calls reroute after a preset interval. Without overflow, the outside calls ring Voice Mail until a port becomes available or the outside caller hangs up.

### ❑ **Message Center Mailbox**

A Message Center Mailbox is shared by more than one extension. Any multiline terminal that has a Message Center Key for the shared mailbox can:

- Listen to the messages stored in the shared mailbox
- Transfer calls to the shared mailbox
- Use many other Voice Mail features previously available only at an extension individual mailbox

A Message Center Mailbox helps co-workers that work together closely – such as members of the same Department Hunt Group or Group. For example, a Group Supervisor can send important messages to the shared Message Center Mailbox, to which any Group member can respond when time allows. Each Agent's Message Center Key flashes when messages are waiting. (The Message Center Mailbox can be a mailbox for an installed, uninstalled or virtual extension.)

### ❑ **Voice Mail Caller ID**

InMail can use ANI/Caller ID information to identify the outside caller that left a message in a user's mailbox. When the message recipient presses TI after hearing a message, they hear the time the message was sent and the outside telephone number of the message sender. Refer to [Caller ID on page 2-109](#) and [T1 Trunking \(with ANI/DNIS Compatibility\) on page 2-1601](#) for more information on setting up this feature.

## **Voice Mail Queuing**

When accessing the voice mail, the system provides a voice mail queue. If all the voice mail ports are busy, any call trying to get to the voice mail is placed in queue. As the voice mail port becomes available, the calls are connected to the voice mail in the order in which they were received.

As the Voice Mail Queue follows Department Hunting programming, the queue can hold a maximum of 10 calls. If the queue is full or if the voice mail ports are not assigned to a Department Group, the calls are handled as though no voice mail queuing feature was enabled. The calls either access voice mail if a port is available or they receive a busy signal.



NOTE

*The Voice Mail Queuing feature does not work with the Conversation Record feature.*

### Message Key will Operate as Voice Mail Key

The system enhances a telephone Message key function when connected to a system which has voice mail installed. When an extension receives a voice mail, the MSG key can be used to check the number of messages in voice mail, as well as call the voice mail to listen to the messages. If no Voice Mail Programmable Function Key is defined (Program 15-07-01, code 77), the telephone Message Waiting LED flashes to indicate new messages.



NOTE

*This option is not available with a networked voice mail – the voice mail must be local.*

### InMail Available

InMail is an “in-skin” full-featured, DSP-based integrated Voice Mail with Automated Attendant. It is present on all SV9100 GCD-CP10 and requires mailbox licenses to activate.

The InMail Automated Attendant answers incoming calls and routes them quickly and efficiently. Integrated Voice Mail features include Conversation Record, Answering Machine Emulation, and Caller ID with Return Call. Interactive Softkeys guide the display telephone user through the extensive InMail feature set.

Table 2-38 SV9100 InMail Part Numbers and Capacities

Part Number	Capacity
	<b>All SV9100 systems have the InMail built in with 16 voice ports. Each station mailbox must be licensed (1012). However, Call Routing, Announcement and Group mailboxes Do Not require mailbox licenses (1012).</b>
<b>P/N 640079</b>	<b>S system (1G) SV9100 SD Card (15 hours recording time)</b>
<b>P/N 640080</b>	<b>E system (4G) SV9100 SD Card (120 hours recording time)</b>
<b>P/N 640814</b>	<b>Additional InMail Voice Mailbox User License (1012)</b>
<b>Bundled with Standard and Premium User License</b>	<b>InMail Email Client License (1014)</b>
<b>Mailboxes</b>	<b>Station Mailboxes = 896</b> <b>Routing Mailboxes = 32</b> <b>Group Mailboxes = 32</b> <b>Total Mailboxes = 960</b>

### InMail: External Transfer Available

The software allows the InMail to perform an external transfer. This allows the InMail to route an incoming Automated Attendant call out of the UNIVERGE SV9100 system on a new trunk based on an Speed Dial number stored in a Dial Action Table.

## InMail: Softkey With Security Code Programming

InMail provides softkeys when programming the security code. These softkeys allow a user to select OK, CLEAR or EXIT following an entry of a new code.

## InMail: Internal Message Notification Timer

When Message Notification places a call out, the system waits up to 30 seconds for ringback, reorder, or busy tone from the trunk. If detected, notification call out processing begins normally. If not detected, the system abandons the call and decrements the Ring No Answer (RNA) count.

## InMail: Directory Dialing

Directory Dialing allows an Automated Attendant caller to reach an extension by dialing the first few letters in the extension user's name. With Directory Dialing, the caller does not have to remember the extension number of the person they wish to reach – just the name.

The following conditions apply to InMail Directory Dialing:

- Remote CCIS extensions are not supported in a centralized directory.
- When set for Unscreened Transfer, calls from the InMail ring at the extension like other transferred calls and display the incoming Caller ID data (if provided by Telco and enabled in programming) while the phone is ringing.
- When set for Screened Transfers, calls from the InMail ring like Intercom calls but do not display incoming Caller ID data (if provided by Telco and enabled in programming) until after the call is answered.

The following steps describe Directory Dialing:

1. When the Automated Attendant answers, it sends the call to the Main Greeting box. The caller must dial a digit to access Directory Dialing.
2. The Directory Dialing Mailbox plays the Directory Dialing Message which asks the caller to dial letters for the name of the person they wish to reach.
3. The caller dials the letters for the person's name plus #. They can dial by first name or last name, depending on how the Directory Dialing Message was recorded and the Directory Dialing Mailbox was set up.
4. InMail searches the list of programmed extension names for a match of the caller-entered letters.
5. Voice prompts announce the first three matches, and allow the caller to dial a digit (1~3) to reach one of the announced matches. Additionally, the caller can dial 4 to hear additional matches (if any).
6. The caller dials the digit for the extension they wish to reach, and InMail sends the call to that extension. The call is sent as a Screened or Unscreened transfer, depending on programming.

For callers to use Directory Dialing, the system must have a name programmed for each extension (up to 15 characters, A~Z, using upper and lower case letters). Each extension user should also have a name recorded in their Subscriber Mailbox. In addition, each extension used by Directory Dialing must be installed and have an active Subscriber Mailbox (Personal or Group).

An outside caller can route to a Master Mailbox or a Routing Mailbox programmed as a Directory Dialing Mailbox from:

- The Answer Tables Answer Schedule Override mailbox, Default mailbox, or Routing mailbox.
- A GOTO action in the Dial Action Table of a Call Routing Mailbox.

**InMail: Multiple Greetings**

The mailbox subscriber can record up to three greetings and make any of the three active. When a caller leaves a message in the subscriber’s mailbox, they hear the active greeting. This allows the subscriber, for example, to record a greeting for work hours, after work, and during vacation. Instead of changing their greeting when they leave the office, they can activate the after work greeting instead.

If the active greeting has not been recorded, a caller leaving a message in the subscriber mailbox hears, *“At the tone, you can leave your message for (extension number or name).”*



REFERENCE

*Refer to the InMail System Guide for complete details on setting these features*

**InMail: Message Playback Options**

The following functions are available:

- Auto Play  
If Auto Play is enabled, New Messages play automatically when an extension user accesses their Mailbox without having to dial 5.
- Change Playback Order  
Playback Order (FIFO: Playback from received call order and LIFO: Playback from New Messages First) can be set by UserPro or mailbox setup.
- Ability to mark message as New  
The user can mark a message as "New" after playback of the message is complete.

**InMail: Dialed and Alternate Transfer**

With Version 6000 or higher, each Dial Action Table digit can have two simultaneous assignments: a Dialed Transfer Assignment and an Alternate Transfer Assignment.

- Dialed Transfer Assignment  
The Dialed Transfer Assignment is a Screened or Unscreened Transfer to an extension or Department Group corresponding to the dialed digit. If digits are dialed in succession then Dialed Transfer Assignment is followed.
- Alternate Transfer Assignment  
The Alternate Assignment overlays the Dialed Transfer Assignment. If the caller dials a single digit, after 1.5 seconds they route to the Alternate Assignment.

## Conditions

- Mailbox licenses are consumed in order beginning with mailbox 1. You must assign mailboxes to extensions starting with mailbox 1 in Program 47-02-01.
- All SV9100 systems have the InMail built in with 16 voice ports which do not require resource licenses (0300).
- Each station mailbox must be licensed (1012). However, Call Routing, Announcement and Group mailboxes Do Not require mailbox licenses (1012).
- The Email Notification feature (1014) license is not required for Group Mailboxes.
- Once Live Record is started, dialed DTMF digits are no longer sent to the outside system for the duration of that call.
- Remote CCIS extensions are not supported in a centralized directory.
- When set for Unscreened Transfer, calls from the InMail ring at the extension like other transferred calls and display the incoming Caller ID data (if provided by Telco and enabled in programming) while the phone is ringing.
- When set for Screened Transfers, calls from the InMail ring like Intercom calls but do not display incoming Caller ID data (if provided by Telco and enabled in programming) until after the call is answered.
- When creating a distribution list, do not use blank destinations within the list. The system considers blank entries to be the end of the list and does not use entries following the blank.
- InMail is supported for centralized voice mail in a KTS to KTS CCIS network.
- InMail is supported for centralized voice mail in a NetLink network. However, replication should be scheduled for non-peak hours of operation.
- Email forwarding requires one (1) InMail Email client license (1014) for each mailbox that will use this feature.
- Constant Message Count is displayed on a telephone display until another activity needs the display (i.e., if a call is made or received on the telephone). To have the message count display again, the telephone needs to receive a new voice mail message or a new call into the voice mailbox.
- Constant Message Count is not supported for Group Mailboxes.
- The SV9100 supports a maximum of 16 InMail ports.
- Answering Machine Emulation is only supported on InMail.
- Audible tones are **not** provided to the multiline terminal when using Live Monitor, only visual notifications are provided for incoming monitored calls.
- The Quick Transfer to Voice Mail feature is allowed when:
  - Listening to the Ring Back Tone (RBT).
  - Listening to the Call Waiting Tone (CWT).

- In Handsfree Answerback Mode.
- In Voice Over Mode.
- When Quick Transfer to Voice Mail is accessed, the Voice Over feature is canceled.
- The Quick Transfer to Voice Mail is not allowed when caller is:
  - Listening to the busy tone (BT).
  - Talking on an internal line.
  - Talking on an outside line.
  - Making a conference call.
- The following options must be changed from WebPro, PCPro or system programming for *group subscriber* mailboxes:
  - Email Notification
  - Message Notification
  - Find-Me Follow-Me
  - Auto Play
- The following options can only be changed from UserPro, WebPro, PCPro or system programming for *station subscriber* mailboxes:
  - Email Notification
  - Message Notification
  - Find-Me Follow-Me
  - Auto Play
- While on an intercom (ICM) call, dial the Quick Transfer Access Code (default: 8) to automatically transfer to that station Voice Mail box.
- Extension ID numbers cannot start with 0, 9, \* or #.
- Mailboxes with extension IDs of 10-32 are not supported as these are already used by fixed system resources.
- Distribution List members can only have 2 or 3 digit extension IDs.
- Live Record does not work for monitored calls.
- Live Record does not work for conference calls.
- Fixed Call Forwarding can be used to transfer a user's unanswered calls to their voice mail. Call Forwarding does not have to be programmed manually by each user.
- Off-premise notification and external extensions require access to outside lines.
- When the voice mail places a call on hold, it uses Group Hold. Any line appearances for the trunk shows the hold flash rate, however, a user cannot pick up this call (a busy signal is heard).

- Updating the system time also updates the InMail time.
- InMail and UM8000 Mail cannot be used at the same time in the same system.
- The displayed message count for New and Saved messages does not update until the mailbox user hangs up and calls back into the InMail.
- InMail and Analog Voice Mail cannot be used at the same time in the same system.
- When the system has the Hotel Motel license (0007), the Message Waiting Indication (MWI) on a DSS Console for an extension is a Green LED. Without the Hotel Motel license the MWI on a DSS Console for an extension is a Red LED.
- When using InMail in a CCIS or Netlink network, 8-digit extensions and mailboxes are not supported.
- InMail does not support Unified Messaging.
- Group mailboxes do not provide a constant message count display.
- With Version 6000 or higher, duplicate Alternate Transfer Destinations cannot be assigned.
- With Version 6000 or higher, “Dialed Transfer” in Program 47-13-01 cannot be set by TelPro when “6: Hang Up” is set in “Action” of Program 47-13-01.
- With Version 6000 or higher, Dialed Transfer cannot be assigned to dial digit \*, # and Timeout.
- With Version 6000 or higher, by default Dialed Transfer is set to “None” for all digits (0~9) in Program 47-13-01.
- With Version 6000 or higher, the extension length for the dialed transfer is based upon how the digit length is set for 1x~9x in Program 11-01.

## Default Settings

Disabled

## System Availability

### Terminals

All Terminals

### Required Component(s)

- 1012 – SV9100 InMail VM Box Lic
- 1014 – SV9100 InMail Email Client Lic
- 0411 – SV9100 Version Lic (R1)



- 0416 – SV9100 Version Lic (R6)



NOTE

*Required if Dialed and Alternate Transfer are used.*

## Related Features

- [Barge-In](#)
- [Caller ID](#)
- [Call Forwarding](#)
- [Central Office Calls, Placing](#)
- [Clock/Calendar Display](#)
- [Contact Center](#)
- [Direct Inward Line \(DIL\)](#)
- [Hold](#)
- [Message Waiting](#)
- [One-Touch Calling](#)
- [Programmable Function Keys](#)
- [Transfer](#)

## Guide to Feature Programming

The **Level 1**, **Level 2** and **Level 3** columns indicate the programs that are assigned when programming this feature in the order they are most commonly used. These levels are used with PCPro and WebPro wizards for feature programming.

- Level 1 – these are the most commonly assigned programs for this feature.
- Level 2 – these are the next most commonly assigned programs for this feature.
- Level 3 – these programs are not often assigned and require an expert level working knowledge of the system to be properly assigned.

Program Number	Program Name/Description	Input Data	Default	Level		
				1	2	3
10-09-01	<p><b>DTMF and Dial Tone Circuit Setup</b> Assign at least one circuit for DTMF reception (0 or 1). Use the following as a guide when allocating DTMF receivers:</p> <ul style="list-style-type: none"> <li>○ In light traffic sites, allocate one DTMF receiver for every 10 devices that use them.</li> <li>○ In heavy traffic sites, allocate one DTMF receiver for every five devices that use them.</li> </ul>	0 = Common Use 1 = Extension Only 2 = Trunk Only	Circuit/Resource 01 ~ 08 = 1 (Extensions) Circuit/Resource 09 ~ 32 = 2 (Trunks) Circuit/Resource 33 ~ 144 = 0 (Common) When PZ-BS10 is installed, 81 ~ 144 are available			✓
11-01	<b>System Numbering</b>	Set the system internal (Intercom) numbering plan. The numbering plan assigns the first and second digits dialed and affects the digits an extension user must dial to access other extensions and features, such as service codes and trunk codes. If the default numbering plan does not meet the site requirements, use this program to tailor the system numbering to the site.	Refer to the Programming Manual for default values.	✓		
11-07-01	<p><b>Department Group Pilot Numbers – Dial</b> Assign a Department Group pilot number for the Voice Mail (eight digits maximum). The extensions are assigned to the group in Program 16-02-01.</p>	Maximum of eight digits.	No Setting	✓		
11-12-08	<p><b>Service Code Setup (for Service Access) – Barge-In</b> Customize the Service Codes used for barge-in service.</p>	MLT, SLT 0 ~ 9, *, # Maximum of eight digits	710		✓	
11-12-52	<p><b>Service Code Setup (for Service Access) – Live Monitoring (SV9100 InMail)</b> Define access code used for InMail Live Monitoring (VRS).</p>	MLT 0 ~ 9, *, # Maximum of eight digits	No Setting		✓	
14-01-22	<p><b>Basic Trunk Data Setup – Caller ID to Voice Mail</b> Enable/Disable the system ability to send the Caller ID digits to voice mail.</p>	Trunks 1 ~ 400 0 = Disable 1 = Enable	0	✓		
14-02-10	<p><b>Analog Trunk Data Setup – Caller ID</b> Enable/Disable a trunk ability to receive Caller ID information.</p>	Trunks 1 ~ 400 0 = No 1 = Yes	0	✓		

Program Number	Program Name/Description	Input Data	Default	Level		
				1	2	3
15-02-26	<p><b>Multiline Telephone Basic Data Setup – MSG Key Operation Mode</b></p> <p>Determine whether an extension MSG key should function as a Message key or Voice Mail key. If set as a Message key, the user can press it to call the voice mail only when they have new messages. If set as a Voice Mail key, it functions as a normal Voice Mail key (it is not active if Centralized Voice Mail is used).</p>	<p>0 = Message Key 1 = Voice Mail Key</p>	0		✓	
15-02-28	<p><b>Multiline Telephone Basic Data setup – Message Waiting Lamp Color</b></p> <p>Determine whether an extension Message Waiting Lamp lights Green or Red when a message is received.</p>	<p>0 = Green 1 = Red</p>	1		✓	
15-02-37	<p><b>Multiline Telephone Basic Data Setup – Voice Mail Message Wait Lamp Color</b></p> <p>Select the color of the large LED when a voice mail message is waiting at the extension.</p>	<p>0 = Green 1 = Red</p>	1		✓	
15-03-01	<p><b>Single Line Telephone Basic Data Setup – SLT Signaling Type</b></p> <p>For each UNIVERGE SV9100 voice mail extension, set this option to 0.</p>	<p>0 = DP 1 = DTMF</p>	1		✓	
15-03-03	<p><b>Single Line Telephone Basic Data Setup – Terminal Type</b></p> <p>Enter 1 for this option to allow a single line port to receive DTMF tones after the initial call setup. Enter 0 to have the port ignore DTMF tones after the initial call setup. For Voice Mail, always enter 1 (e.g., receive DTMF tones).</p>	<p>0 = Normal 1 = Special</p>	0		✓	
15-03-09	<p><b>Single Line Telephone Basic Data Setup – Caller ID Function – for External Module</b></p> <p>This option <i>must</i> be 0 when voice mail is used or the integration code for the disconnect function is incorrect.</p>	<p>0 = Disable (Off) 1 = Enable (On)</p>	0		✓	

Program Number	Program Name/Description	Input Data	Default	Level		
				1	2	3
15-07-01	<p><b>Programmable Function Keys</b></p> <p>Assign a Voice Mail key to an extension. You must enter the Voice Mail key code (code 77) followed by:</p> <ul style="list-style-type: none"> <li>○ Your own extension number if you are setting up your own Voice Mail key.</li> <li>○ A virtual extension number if you are setting up a Message Center key for a virtual extension.</li> <li>○ A co-worker’s extension number if you are setting up a Message Center key for an installed extension.</li> <li>○ An uninstalled extension number if you are setting up a Message Center key for an uninstalled extension.</li> </ul> <p>(Optional) Assign a Voice Mail Record key to an extension (code 78).</p> <p>(Optional) Assign a Personal Answering Machine Emulation key (code 16).</p> <p>(Optional) Use a Call Redirect key (49) to allow a user to transfer a call to another extension or voice mail without answering the call.</p>	<p>Line Key 1 ~ 48</p> <p>0 ~ 99 (Normal Function Code 751 by default)</p> <p>*00 ~ *99 (Appearance Function Code) (Service Code 752 by default)</p>	<p>Refer to the Programming Manual for default values.</p>		✓	
16-02-01	<p><b>Department Group Assignment for Extensions</b></p> <p>Set up the Department Group called by the pilot number and the extension priority when a group is called.</p> <p>Call Pickup Groups are set up in 23-02.</p>	<p>Department Groups 1 ~ 64</p> <p>Priority 1 ~ 9999</p>	<p>Default = 1 extensions in Department Group 1 with priority in port order:</p> <p>Port 1 priority = 1</p> <p>Port 256 priority = 256</p>	✓		
20-02-09	<p><b>System Options for Multiline Telephones – Disconnect Supervision</b></p> <p>Enable/Disable disconnect supervision for the system.</p>	<p>0 = Disable</p> <p>1 = Enable</p>	1		✓	
20-06-01	<p><b>Class of Service for Extensions</b></p> <p>Assign a Class of Service (1 ~ 15) to the voice mail extensions. You should use COS 14 for all time modes.</p>	<p>Day Night/Mode: 1 ~ 8</p> <p>Class of Service of Extensions (1 ~ 15)</p>	<p>Extension port 101 = Class 15</p> <p>All other extension port = Class 1</p>		✓	

Program Number	Program Name/Description	Input Data	Default	Level		
				1	2	3
20-09-01	<p><b>Class of Service Options (Incoming Call Service) – Second Call for DID/DISA/DIL/E&amp;M</b></p> <p>Turn Off or On the extension ability to receive a second call from a DID, DISA, DIL, or tie line caller.</p> <p>➡ <i>With this option set to 1, the destination extension must be busy for a second DNIS caller to ring through. If the destination extension does not have a trunk or CAP key available for the second call and a previous call is ringing the extension but has not yet been answered, the second caller hears busy regardless of this program setting.</i></p>	0 = Off 1 = On	COS 1 ~ 15 = 1		✓	
20-09-02	<p><b>Class of Service Options (Incoming Call Service) – Caller ID Display</b></p> <p>Turn Off or On the Caller ID display at an extension.</p>	0 = Off 1 = On	COS 1 ~ 15 = 0		✓	
20-11-01	<p><b>Class of Service Options (Hold/Transfer Service) – Call Forward All</b></p> <p>Turn Off or On an extension user ability to set Call Forward Immediate.</p>	0 = Off 1 = On	COS 1 ~ 15 = 1		✓	
20-11-02	<p><b>Class of Service Options (Hold/Transfer Service) – Call Forward When Busy</b></p> <p>Turn Off or On an extension user ability to set Call Forwarding when Busy.</p>	0 = Off 1 = On	COS 1 ~ 15 = 1		✓	
20-11-03	<p><b>Class of Service Options (Hold/Transfer Service) – Call Forwarding When Unanswered</b></p> <p>Turn Off or On an extension user ability to set Call Forwarding when Unanswered.</p>	0 = Off 1 = On	COS 1 ~ 15 = 1		✓	
20-11-04	<p><b>Class of Service Options (Hold/Transfer Service) – Call Forwarding (Both Ringing)</b></p> <p>Turn Off or On an extension user ability to set Call Forwarding with Both Ringing.</p>	0 = Off 1 = On	COS 1 ~ 15 = 1		✓	
20-11-05	<p><b>Class of Service Options (Hold/Transfer Service) – Call Forwarding with Follow Me</b></p> <p>Turn Off or On an extension user ability to set Call Forward with Follow Me.</p>	0 = Off 1 = On	COS 1 ~ 15 = 1		✓	
20-11-12	<p><b>Class of Service Options (Hold/Transfer Service) – Call Forwarding Off-Premise (External Call Forwarding)</b></p> <p>Set this option to 0 for voice mail.</p>	0 = Off 1 = On	COS 1 ~ 15 = 0		✓	
20-13-01	<p><b>Class of Service Options (Supplementary Service) – Long Conversation Alarm</b></p> <p>Turn Off or On the Warning Tone for Long Conversation (not for single line telephones).</p>	0 = Off 1 = On	COS 1 ~ 15 = 0		✓	

Program Number	Program Name/Description	Input Data	Default	Level		
				1	2	3
20-13-05	<b>Class of Service Options (Supplementary Service) – Intercom Off-Hook Signaling</b> Turn On or Off an extension ability to send off-hook Signals. ➡ This setting functions with Programs 20-09-07 and 20-13-06 disabled.	0 = Off 1 = On	COS 1 ~ 15 = 1		✓	
20-13-06	<b>Class of Service Options (Supplementary Service) – Automatic Off-Hook Signaling (Automatic Override)</b> Allow a busy extension to Manually (0) or Automatically (1) receive off-hook signals. ➡ This setting is to receive incoming call signaling information during call queuing.	0 = Off 1 = On	COS 1 ~ 15 = 1		✓	
20-13-07	<b>Class of Service Options (Supplementary Service) – Message Waiting</b> Turn Off or On an extension user ability to leave Message Waiting.	0 = Off 1 = On	COS 1 ~ 15 = 1		✓	
20-13-13	<b>Class of Service Options (Supplementary Service) – Continued Dialing (DTMF) Signal on ICM Call</b> Turn Off or On an extension user ability to use Continued Dialing, which allows DTMF signal sending while talking on extension.	0 = Off 1 = On	COS 1 ~ 15 = 1		✓	
20-13-15	<b>Class of Service Options (Supplementary Service) – Barge-In, Initiate</b> You should set this option to 1 for voice mail.	0 = Off 1 = On	COS 1 ~ 15 = 0		✓	
20-13-16	<b>Class of Service Options (Supplementary Service) – Barge-In, Receive</b> Turn Off or On an extension user ability to have other extensions barge-in on calls.	0 = Off 1 = On	COS 1 ~ 15 = 0		✓	
20-13-28	<b>Class of Service Options (Supplementary Service) – Allow Class of Service to be Changed</b> Turn Off or On an extension user ability to change COS via Service Code 677.	0 = Off 1 = On	COS 1 ~ 15 = 0		✓	
20-13-35	<b>Class of Service Options (Supplementary Service) – Block Camp On</b> Set this option to 0 for voice mail.	0 = Off 1 = On	COS 1 ~ 15 = 0		✓	
22-01-04	<b>System Options for Incoming Calls – DIL No Answer Recall Time</b> A DIL that rings its programmed destination longer than this time diverts to the DIL No Answer Ring Group (set in Program 22-08).	0 ~ 64800 seconds	0		✓	

Program Number	Program Name/Description	Input Data	Default	Level		
				1	2	3
22-08-01	<b>DIL/IRG No Answer Destination</b> Assign the DIL No Answer Ring Group.	0 (No Setting) 001 ~ 100 (Incoming Ring Group) 102 (In-Skin/ External Voice Mail or InMail)	1		✓	
24-02-02	<b>System Options for Transfer – MOH or Ringback on Transferred Calls</b> Enable/Disable MOH on Transfer. If set to 0, a transferred caller hears Music on Hold while their call rings the destination extension. If set to 1, a transferred caller hears ringback while their call rings the destination extension. For this option to work with voice mail, the transferred call must be an unscreened transfer.	0 = Hold Tone 1 = Ring Back Tone	0		✓	

**Assign Trunks As Automated Attendant Trunks – Method 1:**

Program Number	Program Name/Description	Input Data	Default	Level		
				1	2	3
22-02-01	<b>Incoming Call Trunk Setup</b> Assign Service Type 4 to each trunk you want to ring into Voice Mail as a Direct Inward Line (DIL).	Trunks 1 ~ 400 0 = Normal 1 = VRS (second dial tone if no VRS installed) 2 = DISA 3 = DID 4 = DIL 5 = E&M Tie line 6 = Delayed VRS 7 = ANI/DNIS 8 = DID(DDI) Mode Switching	0		✓	
22-07-01	<b>DIL Assignment</b> Assign the master/pilot number of the voice mail group from Program 11-07-01 as the DIL destination. If all Voice Mail ports are in the same unique Extension (Department) Group (see Program 16-02 above), the DIL rings another Voice Mail port if its assigned port is busy. <i>For this selection to work, set Program 22-02-01 to 4 (DIL).</i>	Day/Night Modes (1 ~ 8): Extension Number (maximum of eight digits) Pilot Number	No Setting		✓	

### Assign Trunks As Automated Attendant Trunks – Method 2:

Program Number	Program Name/Description	Input Data	Default	Level		
				1	2	3
22-02-01	<b>Incoming Call Trunk Setup</b> Assign Service Type 0 to each trunk you want to ring into Voice Mail as a normal line.	Trunks 1 ~ 400 0 = Normal 1 = VRS (second dial tone if no VRS installed) 2 = DISA 3 = DID 4 = DIL 5 = E&M Tie line 6 = Delayed VRS 7 = ANI/DNIS 8 = DID(DDI) Mode Switching	0		✓	
22-05-01	<b>Incoming Trunk Ring Group Assignment</b> Use this program to assign Normal Ring Trunks (Program 22-02) to Incoming Ring Groups (Program 22-04).	Trunks 1 ~ 400 Incoming Group Number for Day/Night Mode (1 ~ 8): 0 = (No Setting) 001 ~ 100 = (Incoming Group) 102 = (In-Skin/ External Voice Mail or InMail)	1		✓	

### For Either Method:

Program Number	Program Name/Description	Input Data	Default	Level		
				1	2	3
22-04-01	<b>Incoming Extension Ring Group Assignment</b> To enable Voice Mail Overflow, assign selected extensions to a Ring Group that rings for unanswered DILs to Voice Mail ports. In Program 22-06, enter 1 to enable overflow ringing.	Maximum of eight digits.	Extensions 01 ~ 108 (first eight ports) ring for incoming Ring Group 1 calls. No other extensions ring for incoming Ring Group 1 calls.		✓	
22-08-01	<b>DIL/IRG No Answer Destination</b> For Voice Mail Overflow, enter the Ring Group that unanswered DILs to Voice Mail ring after the DIL Call Waiting time (Program 22-01-04).	0 (No Setting) 001 ~ 100 (Incoming Ring Group) 102 (In-Skin/ External Voice Mail or InMail)	1		✓	
24-02-03	<b>System Options for Transfer – Delayed Call Forwarding Time</b> Set the time a transferred call waits at a forwarded extension before routing to the called extension mailbox.	0 ~ 64800 seconds	10		✓	



Program Number	Program Name/Description	Input Data	Default	Level		
				1	2	3
45-01-01	<b>Voice Mail Integration Options – Voice Mail Department Group Number</b> Assign which Extension (Department) Group number is used for the voice mail group.	Department Groups: 0 ~ 64 0 = No Voice Mail	0	✓		
45-01-02	<b>Voice Mail Integration Options – Voice Mail Master Name</b> Assign the Voice Mail master name.	Maximum of 12 characters.	Voice Mail		✓	
45-01-04	<b>Voice Mail Integration Options – Park and Page</b> Enable/Disable the system ability to process the Voice Mail Park and Page (*) commands. You should normally enable this option.	0 = Off 1 = On	1		✓	
45-01-05	<b>Voice Mail Integration Options – Message Wait</b> Enable/Disable the system ability to process the Voice Mail Message Wait (#) commands. You should normally enable this option. If enabled, be sure that the programmed Message Notification strings do not contain the code #9 for trunk access. When using an external voice mail and Centrex transfer, this option should be disabled or the service code #3 in Program 11-12-42 must be changed.	0 = Off 1 = On	1		✓	
45-01-06	<b>Voice Mail Integration Options – Record Alert Tone Interval Time</b> Set the time between Voice Mail Conversation Record alerts.	0 ~ 64800 seconds	30		✓	
45-01-14	<b>Voice Mail Integration Options – CCIS Centralized Voice Mail Number</b> Assign the pilot number to Centralized Voice Mail over CCIS link. Assign only in remote switches.	Dial (maximum of eight digits)	No Setting		✓	
45-01-15	<b>Voice Mail Integration Options – Analog Voice Mail Protocol Selection</b> Assign whether fixed codes or codes used in Program 45-04 are used for analog voice mail protocol.	0: Fixed 1: Program	0		✓	
45-01-16	<b>Voice Mail Integration Options – Voice Mail Fax Digit Add Assignment</b> Assign up to four digits in front of the station number sent to the SLT port when a call is forwarded.	Maximum of four digits.	No Setting		✓	
45-01-17	<b>Voice Mail Integration Options – Reply Mailbox Number</b> Determine Whether or not to include the mailbox number in the analog voice mail protocol.	0 = No 1 = Yes	1	✓		

Program Number	Program Name/Description	Input Data	Default	Level		
				1	2	3
45-01-18	<p><b>Voice Mail Integration Options – Trunk Number Mapping</b></p> <p>Assign the digits of trunk number mapping.</p>	2 ~ 3	2		✓	
47-01-02	<p><b>SV9100 InMail System Options – SV9100 InMail Master Name</b></p> <p>The CHS2UG GW-US must be reset for a change to this program to take effect. Use this option to modify the name for all InMail ports. The system briefly displays this name when a display multiline terminal user calls a Voice Mail port (either by pressing Message, their voice mail key, or by dialing the master number). You should always end the name with the ## characters. The system substitutes the port number for the last #. Using the default name InMail ##, for example, the telephone display shows InMail #1 when calling port 1.</p>	Maximum of 12 characters.	InMail ## (The system substitutes the port number for the # when calling the port).		✓	
47-01-03	<p><b>SV9100 InMail System Options – Subscriber Message Length</b></p> <p>Set the maximum time for recorded messages for:</p> <ul style="list-style-type: none"> <li>○ Subscriber Mailbox users dialing RS to record and send a message.</li> <li>○ Extension users leaving a message in a Subscriber Mailbox.</li> <li>○ Outside Automated Attendant callers accessing a mailbox via a GOTO command and then dialing <b>RS</b> to record and send a message.</li> <li>○ Subscriber Mailbox Greetings.</li> <li>○ Announcement Messages.</li> <li>○ Call Routing Mailbox Instruction Menus.</li> </ul> <p>➡ <i>The Conversation Record time is 10 times the Subscriber Message time. Since the Conversation Record time cannot exceed 4095 seconds, any setting in Subscriber Message time longer than 409 has no effect on the length of recorded conversations.</i></p>	1 ~ 4095 seconds	120		✓	
47-01-04	<p><b>SV9100 InMail System Options – Non-Subscriber Message Length</b></p> <p>Set the maximum time for recorded messages for:</p> <ul style="list-style-type: none"> <li>○ Automated Attendant callers leaving a message or Quick Message in a Subscriber Mailbox.</li> <li>○ Outside callers transferred by an extension user to a Subscriber Mailbox.</li> </ul>	1 ~ 4095 seconds	120		✓	

Program Number	Program Name/Description	Input Data	Default	Level		
				1	2	3
47-01-05	<p><b>SV9100 InMail System Options – Message Backup/Go Ahead Time</b></p> <p>Set the time for how far InMail backs up when a user dials <b>B</b> while listening to a message. This time also sets how far InMail jumps ahead when a user dials <b>G</b> while listening to a message.</p>	1 ~ 60 seconds	5		✓	
47-01-07	<p><b>SV9100 InMail System Options – Digital Pager Callback Number</b></p> <p>Set the <i>Digital Pager Callback Number</i> part of the <i>message Notification callout number</i> for a digital pager. This part of the callout number is appended to the pager service telephone number. Normally, this option should be <b>X*M#</b>, where</p> <ul style="list-style-type: none"> <li>○ <b>X</b> is the number of the extension that generated the notification.</li> <li>○ <b>*</b> is a visual delimiter (to make the pager display easier to read).</li> <li>○ <b>M</b> is the number of new messages in the extension mailbox.</li> <li>○ <b>#</b> is the digit normally used by the pager service for positive disconnect.</li> </ul>	<p><b>Digits</b> (12 maximum, using 0 ~ 9, <b>#</b> and <b>*</b>)</p> <p><b>M</b> (Number of messages – entered by pressing <b>LK1</b>)</p> <p><b>No entry</b> (Entered by pressing <b>HOLD</b>).</p> <p><b>X</b> (Extension number – entered by pressing <b>LK2</b>) InMail automatically replaces the X command with the number of the extension that initially received the message.</p>	X*M#		✓	
47-01-08	<p><b>SV9100 InMail System Options – Delay in Dialing Digital Pager Callback Number</b></p> <p>Set the time delay (0 ~ 99 seconds) that occurs just before InMail dials the Digital Pager Callback Number portion of the Message Notification callout number for a digital pager. Set this delay so the pager service has enough time to connect to the digital pager before sending the callback number. Your pager service may be able to help you determine the best value for this option (0 ~ 99 seconds). When placing a digital pager notification, the system:</p> <ul style="list-style-type: none"> <li>Seizes the trunk specified.</li> <li>Dials the user-entered notification number (in <b>Message + OP + N</b>).</li> <li>Waits the <b>47-01-08: Delay in Dialing Digital Pager Callback Number</b> interval.</li> <li>Dials the number entered in <b>47-01-07: Digital Pager Callback Number</b>.</li> </ul> <p>The system assumes that the notification number completes dialing approximately four seconds after trunk seizure. This means that, by default, the Digital Pager Callback Number is dialed into the pager service about 13 seconds after trunk seizure.</p>	0 ~ 99 seconds	9		✓	

Program Number	Program Name/Description	Input Data	Default	Level		
				1	2	3
47-01-09	<p><b>SV9100 InMail System Options – Wait Between Digital Pager Callout Attempts</b></p> <p>Set the minimum time between unacknowledged or unanswered digital pager Message Notification callouts. (A subscriber acknowledges a digital pager notification by logging onto their mailbox.)</p> <p>After this time expires, InMail tries the callout again (for up to the number of times set in <b>47-01-14: Number of Callout Attempts</b>).</p> <p>If the system dials the callout number and the pager service is busy, it retries the number in one minute.</p>	1 ~ 255 minutes	15		✓	
47-01-10	<p><b>SV9100 InMail System Options – Wait Between Non-Pager Callout Attempts</b></p> <p>Set the minimum time between non-pager Message Notification callouts in which the destination answers, says Hello, dials 1 to acknowledge and then enters the wrong security code.</p>	1 ~ 255 minutes	20		✓	
47-01-11	<p><b>SV9100 InMail System Options – Wait Between Busy Non-Pager Callout Attempts</b></p> <p>Set the time InMail waits after it dials a busy non-pager callout destination, before retrying the callout number.</p>	1 ~ 255 minutes	15		✓	
47-01-12	<p><b>SV9100 InMail System Options – Wait Between RNA Non-Pager Callout Attempts</b></p> <p>Set the time InMail waits, after it dials an unanswered non-pager callout destination, before retrying the callout number.</p> <p>There are three types of unanswered non-pager callouts:</p> <ul style="list-style-type: none"> <li>○ If the callout rings the destination longer than the 47-01-13: Wait for Answer Non-Pager Callout Attempts option.</li> <li>○ If the destination answers, says Hello (or the system detects answer supervision) and then hangs up without dialing 1 to log onto their mailbox. This typically happens if someone unfamiliar with notification answers the callout, or if the callout is picked up by an answering machine.</li> <li>○ If the destination answers, and then hangs up without saying Hello. This typically happens if someone unfamiliar with the notification answers the callout (like the above example), or if the call is picked up by an answering machine with insufficient outgoing message volume.</li> </ul>	1 ~ 255 minutes	30		✓	

Program Number	Program Name/Description	Input Data	Default	Level		
				1	2	3
47-01-13	<p><b>SV9100 InMail System Options – Number of RNA Rings</b></p> <p>If a non-pager callout rings the destination longer than this number of times, InMail marks the call as unanswered (Ring No Answer) and hangs up.</p>	1 ~ 99 (rings)	5		✓	
47-01-14	<p><b>SV9100 InMail System Options – Number of Cascading Attempts</b></p> <p>Set how many times InMail retries an incomplete Message Notification callout. This total includes unacknowledged callouts, callouts to a busy destination, and callouts to an unanswered destination. This option applies to pager and non-pager callouts.</p>	1 ~ 99 (rings)	1		✓	
47-01-15	<p><b>SV9100 InMail System Options – Send Pager Callout Until Acknowledged</b></p> <p>When this option is set to 1, InMail continues to retry a digital pager Message Notification callout until the notification is acknowledged. If this option is set to 0, InMail retries a digital pager Message Notification the number of times specified in <b>47-01-14 Number of Callout Attempts</b>. This option does not apply to Message Notification callouts to telephone numbers.</p> <p>A digital pager notification is acknowledged when the recipient logs onto the mailbox.</p>	0 = No (Disabled) 1 = Yes (Enabled)	0		✓	
47-01-16	<p><b>SV9100 InMail System Options – Name Format</b></p> <p>Specify how names are displayed.</p>	0 = 1st Last 1 = Last 1st	0		✓	
47-02-01	<p><b>SV9100 InMail Station Mailbox Options – Mailbox Type</b></p> <p>Enable/Disable the mailbox. An extension mailbox is not accessible when it is disabled (even though its stored messages and configuration are retained in memory.) If disabled, a user pressing <b>Message</b> initiates a remote Logon and is asked to enter their mailbox number. A voice prompt then announces: <i>That mailbox does not exist.</i></p> <p>To make programming easier, consider associating a mailbox number with a station port. For example, mailbox 1 could correspond to port 1, which in turn corresponds to extension 101.</p>	0 = None 1 = Personal 2 = Group	1	✓		

Program Number	Program Name/Description	Input Data	Default	Level		
				1	2	3
47-02-02	<p><b>SV9100 InMail Station Mailbox Options – Mailbox Number</b></p> <p>Select the extension number associated with the mailbox you are programming. Normally, mailbox 1 should use Mailbox Number 101, mailbox 2 should use Mailbox Number 102, etc. To make programming easier, consider associating a mailbox number with a station port. For example, mailbox 1 could correspond to port 1, which in turn corresponds to extension 101.</p>	Digits (maximum of eight using 0 ~ 9)	Mailbox 1 = 101 Mailboxes 2 ~ 64 = 102 ~ 164 Mailboxes 65 ~ 896 = No Entry	✓		
47-02-03	<p><b>SV9100 InMail Station Mailbox Options – Number of Messages</b></p> <p>Set the maximum number of messages that can be left in the Subscriber Mailbox. If a caller tries to leave a message after this limit is reached, they hear, “<i>That mailbox is full.</i>” InMail then hangs up.</p>	0 ~ 99 messages To conserve storage space, enter 0 for all unused mailboxes.	99 for mailbox 1 20 for all other mailboxes		✓	
47-02-04	<p><b>SV9100 InMail Station Mailbox Options – Message Playback Order</b></p> <p>Set the Subscriber Mailbox message playback order. When a subscriber listens to their messages, InMail can play the oldest message or the newest message first.</p>	0 = FIFO (first-in/ first-out, or oldest messages first). 1 = LIFO (last-in/ first-out, or newest messages first)	0		✓	
47-02-05	<p><b>SV9100 InMail Station Mailbox Options – Auto Erase/Save of Messages</b></p> <p>Determine what happens when a Subscriber Mailbox user listens to a complete new message and then exits the mailbox without either saving (<b>SA</b>) or erasing (<b>E</b>) the message. Depending on the setting of this option, InMail either automatically saves or erases the message. If the mailbox user hangs up before listening to the <i>entire</i> new message, InMail retains the message as a new message.</p>	0 = Erase After the subscriber listens to the entire new message and hangs up, InMail erases the message. 1 = Save After the subscriber listens to the entire new message and hangs up, InMail saves the message.	1		✓	
47-02-06	<p><b>SV9100 InMail Station Mailbox Options – Message Retention</b></p> <p>Determine how long a Subscriber Mailbox retains held and saved messages. If a message is left in a Subscriber Mailbox longer than this interval, InMail deletes it.</p>	1 ~ 99 Days 0 (Indefinite)	0		✓	

Program Number	Program Name/Description	Input Data	Default	Level		
				1	2	3
47-02-07	<p><b>SV9100 InMail Station Mailbox Options – Recording Conversation Beep</b></p> <p>Enable/Disable the Conversation Record beep. If enabled, all parties on a call hear the voice prompt <i>Recording</i> followed by a single beep when the extension user initiates Conversation Record. If disabled, the voice prompt and beep do not occur. When you disable the Conversation Record beep, the following voice prompts do not occur while InMail records the conversation:</p> <p><i>Recording (followed by a beep)</i></p> <p><i>That mailbox is full (if the mailbox message storage capacity is reached)</i></p> <p><i>You have reached the recording limit (if the recorded message is too long)</i></p> <p>The SV9100 telephone system software provides an additional Conversation Record beep. This beep repeats according to the setting of <b>Program 45-01-06: Voice Mail Integration Options: Record Alert Tone Interval Time</b>.</p>	<p>0 = Disable</p> <p>1 = Enable</p>	1		✓	
47-02-08	<p><b>SV9100 InMail Station Mailbox Options – Message Waiting Lamp</b></p> <p>Enable/Disable Message Waiting lamp at the extension associated with the Subscriber mailbox. For Subscriber Mailboxes, you should enable this option. For Guest Mailboxes, you should disable it.</p>	<p>0 = Disable</p> <p>1 = Enable</p>	1		✓	
47-02-09	<p><b>SV9100 InMail Station Mailbox Options – Auto Attendant Direct to Voice Mail</b></p> <p>Enable/Disable Auto Attendant Do Not Disturb. When a subscriber enables this option, an Automated Attendant caller routes directly to the mailbox, hears the greeting, and is asked to leave a message. A subscriber can also enable this option while recording their mailbox greeting.</p>	<p>0 = Disable</p> <p>1 = Enable</p>	0		✓	
47-02-10	<p><b>SV9100 InMail Station Mailbox Options – Forced Unscreened Transfer</b></p> <p>Enable/Disable Automated Attendant Forced Unscreened Transfer for the Subscriber Mailbox. If enabled, each Screened Transfer (TRF) to the extension is converted to an Unscreened Transfer (UTRF). If disabled, Screened Transfers from the Automated Attendant occur normally.</p>	<p>0 = Disable</p> <p>1 = Enable</p>	0		✓	

Program Number	Program Name/Description	Input Data	Default	Level		
				1	2	3
47-02-11	<p><b>SV9100 InMail Station Mailbox Options – Auto Time Stamp</b></p> <p>Enable/Disable Auto Time Stamp for the Subscriber Mailbox. If enabled, after the subscriber listens to a message InMail announces the time and date the message was left. Auto Time Stamp also announces the message sender (if known). A subscriber can also enable Auto Time Stamp from their mailbox.</p>	<p>0 = Disable 1 = Enable</p>	0		✓	
47-02-12	<p><b>SV9100 InMail Station Mailbox Options – System Administrator</b></p> <p>Designate the Subscriber Mailbox as a System Administrator. This allows the subscriber to use the <b>SA</b> options after logging into their mailbox.</p>	<p>0 = No (Disable) 1 = Yes (Enable)</p>	<p>Mailbox 1 (101) = 1 Other mailboxes = 0</p>		✓	
47-02-13	<p><b>SV9100 InMail Station Mailbox Options – Dialing Option</b></p> <p>Dialing Option provides additional dialing options for Next Call Routing Mailbox calls (see <i>Next Call Routing Mailbox</i> below). If enabled, a caller who accesses the Subscriber Mailbox to leave a message can dial any option in the Next Call Routing Mailbox Dial Action Table. If disabled, the caller can dial only 0 (to use the Next Call Routing Mailbox 0 action).</p>	<p>0 = Disable 1 = Enable</p>	0		✓	
47-02-14	<p><b>SV9100 InMail Station Mailbox Options – Next Call Routing Mailbox</b></p> <p>Assign a Next Call Routing Mailbox to the Subscriber Mailbox. This provides callers with additional dialing options while listening to a Subscriber Mailbox recorded or default greeting. The digits the caller can dial depends on the setting of the Next Call Routing Mailbox and Alternate Next Call Routing Mailbox options.</p>	<p>Call Routing Mailbox Number (1 ~ 3 digits, 01 ~ 016) No entry (Entered by pressing CLEAR)</p>	<p>1 (Call Routing Mailbox 01) By default, Call Routing Mailbox numbers are 01 ~ 08</p>		✓	
47-02-15	<p><b>SV9100 InMail Station Mailbox Options – Directory List Number</b></p> <p>Set up a station/extension mailbox directory list.</p>	<p>0 = None 1 ~ 8 = List Number * = All</p>	0		✓	
47-02-26	<p><b>SV9100 InMail Station Mailbox Options – Auto Play</b></p> <p>Use this option to set the Subscriber Mailbox message Auto Play option. When a subscriber logs into their mailbox, InMail can automatically play new messages, or not.</p>	<p>0 = Disabled 1 = Enabled</p>	0		✓	
47-03-02	<p><b>SV9100 InMail Group Mailbox Options – Mailbox Number</b></p> <p>The Group Mailbox Number is the same as the Department Group master (pilot) number. Use this option to select the Department Group master (pilot) number associated with the Master Mailbox you are programming.</p>	<p>Digits (maximum of eight using 0 ~ 9) No Setting (entered by pressing <b>Hold</b>)</p>	No Setting		✓	



Program Number	Program Name/Description	Input Data	Default	Level		
				1	2	3
47-03-03	<b>SV9100 InMail Group Mailbox Options – Mailbox Type</b> Set the Master Mailbox type.	0 = None 1 = Subscriber 2 = Routing	1		✓	
47-06-01	<b>Group Mailbox Subscriber Options – Number of Messages</b> Set the maximum number of messages that can be left in the Subscriber Mailbox. If a caller tries to leave a message after this limit is reached, they hear, “ <i>That mailbox is full</i> ”. InMail then hangs up.	0 ~ 99 messages To conserve storage space, enter 0 for all unused mailboxes.	20		✓	
47-06-02	<b>Group Mailbox Subscriber Options – Message Playback Order</b> Set the Subscriber Mailbox message playback order. When a subscriber listens to their messages, InMail can play the oldest messages or the newest messages first.	0 = FIFO (first-in/first-out, or oldest messages first). 1 = LIFO (last-in/first-out, or newest messages first).	0		✓	
47-06-03	<b>Group Mailbox Subscriber Options – Auto Erase/Save of Messages</b> Determine what happens when a Subscriber Mailbox user completely listens to a new message and then exits the mailbox without either saving (SA) or erasing (E) the message. Depending on the setting of this option, InMail either automatically saves or erases the message. If the mailbox user hangs up before listening to the entire new message, InMail retains the message as a new message.	0 = Erase After the subscriber listens to the entire new message and hangs up, InMail erases the message. 1 = Save After the subscriber listens to the entire new message and hangs up, InMail saves the message.	1		✓	
47-06-04	<b>Group Mailbox Subscriber Options – Message Retention</b> Determine how long a Subscriber Mailbox retains held and saved messages. If a message is left in a Subscriber Mailbox longer than this interval, InMail deletes it.	1 ~ 99 days 0 (Indefinite)	0		✓	

Program Number	Program Name/Description	Input Data	Default	Level		
				1	2	3
47-06-05	<p><b>Group Mailbox Subscriber Options – Recording Conversation Beep</b></p> <p>Enable/Disable the Conversation Record beep. If enabled, all parties on a call hear the voice prompt <i>Recording</i> followed by a single beep when the extension user initiates Conversation Record. If disabled, the voice prompt and beep do not occur. When you disable the Conversation Record beep, the following voice prompts do not occur while InMail records the conversation:</p> <p>Recording (followed by a beep) That mailbox is full (if the mailbox message storage capacity is reached).</p> <p>You have reached the recording limit (if the recorded message is too long).</p> <p>The SV9100 telephone system software provides an additional Conversation Record beep. This beep repeats according to the setting of Program 45-01-06: Voice Mail Integration Options: Record Alert Tone Interval Time.</p>	<p>0 = No (Disable)</p> <p>1 = Yes (Enable)</p>	1		✓	
47-06-06	<p><b>Group Mailbox Subscriber Options – Message Waiting Lamp</b></p> <p>Enable/Disable Message Waiting lamp at the extension associated with the Subscriber mailbox. For Subscriber Mailboxes, you should enable this option. For Guest Mailboxes, you should disable this option.</p>	<p>0 = Disable</p> <p>1 = Enable</p>	1		✓	
47-06-07	<p><b>Group Mailbox Subscriber Options – Auto Attendant Do Not Disturb</b></p> <p>Enable/Disable Auto Attendant Do Not Disturb. When a subscriber enables Auto Attendant Do Not Disturb, an Automated Attendant caller routes directly to the mailbox, hears the greeting, and is asked to leave a message. A subscriber can also enable Auto Attendant Do Not Disturb while recording their mailbox greeting.</p>	<p>0 = Disable</p> <p>1 = Enable</p>	0		✓	
47-06-08	<p><b>Group Mailbox Subscriber Options – Forced Unscreened Transfer</b></p> <p>Enable/Disable Automated Attendant Forced Unscreened Transfer for the Subscriber Mailbox. If enabled, each Screened Transfer (TRF) to the extension is converted to an Unscreened Transfer (UTRF). If disabled, Screened Transfers from the Automated Attendant occur normally.</p>	<p>0 = Disable</p> <p>1 = Enable</p>	0		✓	

Program Number	Program Name/Description	Input Data	Default	Level		
				1	2	3
47-06-09	<p><b>Group Mailbox Subscriber Options – Auto Time Stamp</b></p> <p>Enable/Disable Auto Time Stamp for the Subscriber Mailbox. If enabled, after the subscriber listens to a message InMail announces the time and date the message was left. Auto Time Stamp also announces the message sender (if known). A subscriber can also enable Auto Time Stamp from their mailbox.</p>	<p>0 = Disable 1 = Enable</p>	0		✓	
47-06-10	<p><b>Group Mailbox Subscriber Options – System Administrator</b></p> <p>Designate the Subscriber Mailbox as a System Administrator. This allows the subscriber to use the options after logging into their mailbox.</p>	<p>0 = Disable 1 = Enable</p>	0		✓	
47-06-11	<p><b>Group Mailbox Subscriber Options – Dialing Option</b></p> <p>Dialing Option provides additional dialing options for Next Call Routing Mailbox calls (see <i>Next Call Routing Mailbox</i> below). If enabled, a caller who accesses the Subscriber Mailbox to leave a message can dial any option in the Next Call Routing Mailbox Dial Action Table. If disabled, the caller can dial only 0 (to use the Next Call Routing Mailbox 0 action).</p>	<p>0 = Disable 1 = Enable</p>	0		✓	
47-06-12	<p><b>Group Mailbox Subscriber Options – Next Call Routing Mailbox</b></p> <p>Assign a Next Call Routing Mailbox to the Subscriber Mailbox. This provides callers with additional dialing options while listening to a Subscriber Mailbox recorded or default greeting. The digits the caller can dial depends on the setting of the Next Call Routing Mailbox and Alternate Next Call Routing Mailbox options.</p>	<p>Call Routing Mailbox Number (0 ~ 32) No entry (entered by pressing <b>CLEAR</b>)</p>	(default = 1) (Call Routing Mailbox 01) By default, Call Routing Mailbox numbers are 01 = 16		✓	
47-06-13	<p><b>Group Mailbox Subscriber Options – Directory List Number</b></p> <p>Specify the Directory List Number to which the Group Mailbox belongs. Use to set up a Master Mailbox assigned as a Subscriber Mailbox in 47-03-03.</p>	<p>0 = None 1 ~ 8 = List Number * = All</p>	0		✓	
47-06-24	<p><b>Group Mailbox Subscriber Options – Auto Play</b></p> <p>Use this option to set the Group Subscriber Mailbox message auto play option. When a user logs into the group mailbox, InMail can automatically play new messages, or not.</p>	<p>0 = Disabled 1 = Enabled</p>	0		✓	

Program Number	Program Name/Description	Input Data	Default	Level		
				1	2	3
47-07-02	<p><b>SV9100 InMail Routing Mailbox Options – Routing Mailbox Type</b></p> <p>Set the Routing Mailbox type.</p>	<p>0 = None                      1 = Call Routing                      2 = Announcement                      3 = Directory                      4 = Distribution</p>	<p>Mailboxes                      01 ~ 08 = 1                      (Call Routing)                      Mailboxes                      09 ~ 32 = 2                      (Announcement)</p>		✓	
47-08-01	<p><b>Call Routing Mailbox Options – Dial Action Table</b></p> <p>Assign the Dial Action Table to the Call Routing Mailbox. The Dial Action Table defines the dialing options for the call Routing Mailbox.</p>	<p>1 ~ 32                      (Dial Action Table 1 ~ 32)</p>	<p>1 (Dial Action Table 1)</p>		✓	
47-08-02	<p><b>Call Routing Mailbox Options – Screened Transfer Timeout</b></p> <p>Set the time a Screened Transfer (TRF) from the Automated Attendant rings an unanswered extension before recalling.</p> <p>This option has a similar function as Customize: Mailbox Options: Call Routing: [Call Handling] Options: Delay Rings Before Redirect Transfer in InMail.</p>	<p>0 ~ 255 seconds                      Entering 0 causes immediate recall.</p>	<p>15</p>		✓	
47-08-03	<p><b>Call Routing Mailbox Options – Time Limit for Dialing Commands</b></p> <p>Determine the time InMail waits for an Automated Attendant caller to dial before routing the call to the Timeout destination. <i>Be sure your Dial Action Tables have a Timeout action programmed.</i></p> <p>If the caller waits too long to dial:                      When the associated Dial Action Table has a Timeout action programmed, the caller routes to that destination.                      When the associated Dial Action Table does not have a Timeout action programmed, the Instruction Menu repeats three times and then InMail hangs up.</p>	<p>0 ~ 99 seconds                      Entering 0 causes the Automated Attendant to immediately route callers to the Timeout destination programmed in the active Dial Action Table.</p>	<p>5</p>		✓	
47-08-04	<p><b>Call Routing Mailbox Options – Fax Detection</b></p> <p>Enable/Disable Fax detection for the Call Routing Mailbox. When Enabled, the InMail Automated Attendant (when using this mailbox) detects incoming Fax CNG tone. The Fax then routes to the company Fax Machine according to the setting in Program 47-01-06: Fax Extension. When Disabled, the Automated Attendant does not detect incoming Fax calls.</p>	<p>0 = Disabled                      1 = Enabled</p>	<p>0</p>		✓	

Program Number	Program Name/Description	Input Data	Default	Level		
				1	2	3
47-09-01	<p><b>Announcement Mailbox Options – Next Call Routing Mailbox</b></p> <p>If you set up an Announcement Mailbox to answer Automated Attendant calls, use this option to provide additional routing options to the Automated Attendant callers. This option interacts with <i>Repeat Count</i> and <i>Hang Up After</i> below.</p> <p>For more detail on this interaction, refer to Direct Announcement Mailbox Routing and Routed Announcement Mailbox Routing in the InMail System Guide.</p>	<p>Call Routing Mailbox Number (1 ~ 32)</p> <p>0 = Undefined</p>	0		✓	
47-09-02	<p><b>Announcement Mailbox Options – Repeat Count</b></p> <p>Enter the number of times you want the Announcement Mailbox message to repeat to callers. After an Announcement Mailbox caller initially listens to the message, it repeats the number of times specified in this option. This option interacts with <i>Next Call Routing Mailbox</i> and <i>Hang Up After</i> when providing routing options.</p> <p>For more detail on this interaction, refer to Direct Announcement Mailbox Routing and Routed Announcement Mailbox Routing in the InMail System Guide.</p>	<p>0 (No Repeats)</p> <p>1 ~ 10 (Announcement repeats 1 ~ 10 times)</p>	0		✓	
47-09-03	<p><b>Announcement Mailbox Options – Hang Up After</b></p> <p>Use this option along with <i>Next Call Routing Mailbox</i> and <i>Repeat Count</i> above to provide additional routing options to Automated Attendant callers.</p> <p>For more detail on this interaction, refer to Direct Announcement Mailbox Routing and Routed Announcement Mailbox Routing in the InMail System Guide.</p>	<p>0 = None</p> <p>1 = Goodbye</p> <p>2 = Silent</p>	0		✓	
47-10-01	<p><b>SV9100 InMail Trunk Options – Answer Table Assignment</b></p> <p>Assign an InMail Answer Table to each Direct Inward Line (DIL) the Automated Attendant should answer. The Automated Attendant follows the routing specified by the selected Answer Table.</p>	<p>Answer Table (1 ~ 16)</p>	1		✓	
47-11-01	<p><b>InMail Answer Table Options – Answer Schedule Override</b></p> <p>Enable/Disable Answer Schedule Override for the selected Answer Table. If enabled (and you make an entry for <i>Override Mailbox</i> below), the active Answer Table routes calls to the Override Mailbox.</p>	<p>0 = Disable</p> <p>1 = Enable</p>	0		✓	

Program Number	Program Name/Description	Input Data	Default	Level		
				1	2	3
47-11-02	<p><b>InMail Answer Table Options – Override Mailbox Category</b></p> <p>Specify the category of the mailbox where Automated Attendant calls should route when you enable Answer Schedule Override.</p> <p>InMail mailbox categories are Subscriber Mailbox, Master Mailbox, and Routing Mailbox. InMail handles the routing according to the type of mailbox (Subscriber, Call Routing, or Announcement) within the specified category:</p> <ul style="list-style-type: none"> <li>○ If the Override Mailbox is a Subscriber Mailbox, the outside caller hears the mailbox greeting (if recorded) and can leave a message.</li> <li>○ If the Override Mailbox is an Announcement Mailbox, the outside caller hears the recorded announcement. Depending on how the Announcement Mailbox is programmed, InMail then hangs up, reroutes the call, or provides additional dialing options.</li> <li>○ If the Override Mailbox is a Call Routing Mailbox, the outside caller hears the instruction menu and can dial any option allowed by the associated Dial Action Table.</li> </ul> <p>➔ <i>If any Input Data value is entered, the terminal displays the Override Mailbox Number selection below.</i></p>	<p>0 = Undefined</p> <p>1 = Subscriber Mailbox – STA</p> <p>2 = Group Mailbox</p> <p>3 = Routing Mailbox</p>	0		✓	
	<p><b>Override Mailbox Number</b></p> <p>Specify the mailbox where Automated Attendant calls should route when you enable Answer Schedule Override. The mailbox number you select in this option should match the mailbox category specified in <b>47-11-02: Override Mailbox Category</b> above.</p>	<p>Digits (maximum of three using 0 ~ 9)</p>	No Entry		✓	

Program Number	Program Name/Description	Input Data	Default	Level		
				1	2	3
47-11-03	<p><b>InMail Answer Table Options – Default Mailbox Category</b></p> <p>Specify the category of mailbox used as the Default Mailbox. InMail mailbox categories are Subscriber Mailbox, Master Mailbox, and Routing Mailbox. InMail uses the Default Mailbox when an Answer Schedule is not in effect.</p> <p>InMail handles the routing according to the type of mailbox (Subscriber, Call Routing, or Announcement) within the specified category:</p> <ul style="list-style-type: none"> <li>○ If the Default Mailbox is a Subscriber Mailbox, the outside caller hears the mailbox greeting (if recorded) and can leave a message.</li> <li>○ If the Default Mailbox is an Announcement Mailbox, the outside caller hears the recorded announcement. Depending on how the Announcement Mailbox is programmed, InMail then hangs up, reroutes the call, or provides additional dialing options.</li> <li>○ If the Default Mailbox is a Call Routing Mailbox, the outside caller hears the instruction menu and can dial any option allowed by the associated Dial Action Table.</li> </ul> <p>➡ <i>If any Input Data value is entered, the terminal displays the Default Mailbox Number selection (below).</i></p>	<p>0 = Undefined                      1 = Subscriber Mailbox - STA                      2 = Group Mailbox                      3 = Routing Mailbox</p>	<p>Answer Table 1 = 3                      Answer Table 2 ~ 16 = 0</p>		✓	
	<p><b>InMail Answer Table Options – Default Mailbox Number</b></p> <p>Set the Answer Table Default Mailbox number. InMail uses the Default Mailbox when an Answer Schedule is not in effect. By default, this occurs at all times <i>other than</i> Monday through Friday from 8:30 AM to 5:00 PM.</p>	<p>Digits (maximum of three using 0 ~ 9)</p>	<p>Answer Table 1 = 1                      Answer Table 2 ~ 16 = No Entry</p>		✓	
47-11-04	<p><b>InMail Answer Table Options – Next Answer Table</b></p> <p>When 10 Answer Schedules in an Answer Table are not enough, use this option to link two Answer Tables together. InMail treats the two linked tables as a single 20 entry Answer Table.</p>	<p>Answer Table (1 ~ 16)                      0 = Undefined</p>	<p>0</p>		✓	

Program Number	Program Name/Description	Input Data	Default	Level		
				1	2	3
47-12-01	<p><b>InMail Answer Schedules – Schedule Type</b>                      Assign a Schedule Type to the selected Answer Schedule. The Schedule Type determines how the Answer Schedule answers calls.                      The schedule can be one of the following types:</p> <ul style="list-style-type: none"> <li>○ <b>1. Day of the Week</b> A Type 1 Answer Schedule runs on a specific day of the week. For this type of schedule, you select:                          The day of the week the schedule should run:                          The schedule start time.                          The schedule end time                          The Call Routing or Announcement Mailbox used to answer calls.</li> <li>○ <b>2. Range of Days</b> A Type 2 Answer Schedule runs for a range of days. For this type of schedule, you select:                          The day of the week the schedule should start.                          The day of the week the schedule should stop.                          The time on the start day the schedule should start.                          The time on the stop day the schedule should stop.                          The Call Routing or Announcement Mailbox used to answer the calls.</li> <li>○ <b>3. Date</b> A type 3 Answer Schedule runs only on a specific day of the year. For this type of schedule, you select:                          The specific date the schedule should run.                          On the selected date, the time the schedule should start.                          On the selected date, the time the schedule should stop.                          The Call Routing or Announcement Mailbox used to answer the calls.</li> </ul>	0 = Undefined 1 = Day of the Week 2 = Range of Days 3 = Date	Answer Table 1/ Schedule 1 = 2 All other schedules = 0		✓	



Program Number	Program Name/Description	Input Data	Default	Level		
				1	2	3
47-12-02	<p><b>InMail Answer Schedules – Answering Mailbox Category</b></p> <p>Specify the category of mailbox to which Automated Attendant calls should route when the schedule is in effect. InMail mailbox categories are Subscriber Mailbox, Master Mailbox, or Routing Mailbox.</p> <p>InMail handles the routing according to the exact type of Subscriber, Master, or Routing Mailbox specified.</p> <p>If the Answering Mailbox is a Subscriber Mailbox, the outside caller hears the mailbox greeting (if recorded) and can leave a message.</p> <p>If the Answering Mailbox is an Announcement Mailbox, the outside caller hears the recorded announcement. Depending on how the Announcement Mailbox is programmed, InMail then hangs up, reroutes the call, or provides additional dialing options.</p> <p>If the Answering Mailbox is a Call Routing Mailbox, the outside caller hears the instruction menu and can dial any option allowed by the associated Dial Action Table.</p>	<p>0 = Undefined</p> <p>1 = Subscriber Mailbox - STA</p> <p>2 = Group Mailbox</p> <p>3 = Routing Mailbox</p>	3		✓	
	<p><b>Answering Mailbox Number</b></p> <p>Set the number of the Answering Mailbox the Automated Attendant uses when the selected schedule is in effect. This mailbox is defined in 47-12-02: Answering Mailbox Category.</p>	<p>Digits (maximum of three using 0 ~ 9)</p>	<p>Answer Table 1/ Schedule 1 = 1 All Other Answer Schedules = No Entry</p>		✓	
47-12-03	<p><b>InMail Answer Schedules – Day of the Week</b></p> <p>For Day of the Week (Type 1) Answer Schedules, select the day of the week the Answer Schedule should be active.</p>	<p>1 = Sunday</p> <p>2 = Monday</p> <p>3 = Tuesday</p> <p>4 = Wednesday</p> <p>5 = Thursday</p> <p>6 = Friday</p> <p>7 = Saturday</p>	1		✓	
47-12-04	<p><b>InMail Answer Schedules – Start Day</b></p> <p>For Range of Days (Type 2) Answer Schedules, select the day of the week the Answer Schedule should start.</p>	<p>1 = Sunday</p> <p>2 = Monday</p> <p>3 = Tuesday</p> <p>4 = Wednesday</p> <p>5 = Thursday</p> <p>6 = Friday</p> <p>7 = Saturday</p>	<p>1 Answer Table 1/ Schedule 1 = 2 All Other Schedules = 1</p>		✓	

Program Number	Program Name/Description	Input Data	Default	Level		
				1	2	3
47-12-05	<b>InMail Answer Schedules – End Day</b> For Range of Days (Type 2) Answer Schedules, select the day of the week the Answer Schedule should end.	1 = Sunday 2 = Monday 3 = Tuesday 4 = Wednesday 5 = Thursday 6 = Friday 7 = Saturday	Answer Table 1/ Schedule 1 = 6 All Other Answer Schedules = 1		✓	
47-12-06	<b>InMail Answer Schedules – Date</b> For Date (Type 3) Answer Schedules, select the date the Answer Schedule should be active.	MMDD For example: - 0101 = January 1 - 1231 = December 31 - 0000 = No date set	0000		✓	
47-12-07	<b>InMail Answer Schedules – Schedule Start Time</b> Specify the time the Answer Schedule should start. It applies to Day of the Week (Type 1), Range of Days (Type 2), and Date (Type 3) schedules. (To make a schedule run continuously, make the same entry for 47-12-07: Schedule Start Time and 47-12-08: Schedule End Time.)	HHMM (24-hour clock) For example: - 0130 = 1:30AM - 1700 = 5:00PM	Default: Answer Table 1/ Schedule 1 = 08:30 (8:30AM) All other schedules are 0000		✓	
47-12-08	<b>InMail Answer Schedules – Schedule End Time</b> Specify the time the Answer Schedule should start. It applies to Day of the Week (Type 1), Range of Days (Type 2), and Date (Type 3) schedules. (To make a schedule run continuously, make the same entry for 47-12-07: Schedule Start Time and 47-12-08: Schedule End Time.)	HHMM (24-hour clock) For example: - 0130 = 1:30AM - 1700 = 5:00PM - 0000 = Undefined	Default: Answer Table 1/ Schedule 1 = 1700 All Other Schedules = 0000		✓	
47-13-01	<b>SV9100 InMail Dial Action Tables</b> Refer to the UNIVERGE SV9100 InMail System Guide, for complete programming details.		Refer to the Programming Manual for default values.		✓	
80-03-01	<b>DTMF Tone Receiver Setup – Detect Level</b> Set the criteria for DTMF dial, ringback and busy tones.	0 = 0dBm ~ -25dBm 1 = -5dBm ~ -30dBm 2 = -10dBm ~ -35dBm 3 = -15dBm ~ -40dBm 4 = -20dBm ~ -45dBm 5 = -25dBm ~ -50dBm 6 = -30dBm ~ -55dBm	Type 1 ~ 5 = 0			✓

Program Number	Program Name/Description	Input Data	Default	Level		
				1	2	3
80-04-01	<b>Call Progress Tone Detector Setup – Detect Level</b> Define the various levels and timers for the Call Progress Tone Detector. Use this option to set the Detection Level.	0 = 0dBm ~ -25dBm 1 = -5dBm ~ -30dBm 2 = -10dBm ~ -35dBm 3 = -15dBm ~ -40dBm 4 = -20dBm ~ -45dBm 5 = -25dBm ~ -50dBm 6 = -30dBm ~ -55dBm	Type 1 (DT) – 0 (-25dBm) Type 2 (BT) – 0 (-25dBm) Type 3 (RBT) – 0 (-25dBm) Type 4 (SBT) – 0 (-25dBm) Type 5 – 0			✓

**Delay Announcement:**



*Only use if Announcement Mailboxes are used for Delay Announcements.*

NOTE

Program Number	Program Name/Description	Input Data	Default	Level		
				1	2	3
41-19-01	<b>Voice Mail Delay Announcement – Delay Message Start Timer</b> Determine the time the system waits before playing the Delay Message.	0 ~ 64800 seconds	0	✓		
41-19-02	<b>Voice Mail Delay Announcement – Mailbox Number for 1st Announcement Message</b> Assign Voice Mail Announcement Mailbox as the message source for the 1st Announcement Message.	Dial (maximum of eight digits)	No Setting	✓		
41-19-03	<b>Voice Mail Delay Announcement – 1st Delay Message Sending Count</b> Determine the 1st Delay Message Sending Count. This entry must be set to 1 or higher for the message to play.	0 = No message is played. 1 ~ 255	0		✓	
41-19-04	<b>Voice Mail Delay Announcement – Mailbox Number for 2nd Announcement Message</b> Assign Voice Mail Announcement Mailboxes as the message source for the 2nd Announcement Message.	Dial (maximum of eight digits)	No Setting		✓	
41-19-05	<b>Voice Mail Delay Announcement – 2nd Delay Message Sending Count</b> Determine the 2nd Delay Message Sending Count. This entry must be set to 1 or higher for the message to play.	0 = No message is played. 1 ~ 255	0		✓	
41-19-06	<b>Voice Mail Delay Announcement – Wait Tone Type at Message Interval</b> Determine what the caller hears between the messages.	0 = Ring Back Tone 1 = Music On Hold Tone 2 = Background Music Source	0		✓	

Program Number	Program Name/Description	Input Data	Default	Level		
				1	2	3
41-19-07	<b>Voice Mail Delay Announcement – Forced Disconnect Time after 2nd Announcement</b> Assign the time the system waits after the end of the delay message before disconnecting.	0 ~ 64800 seconds	0		✓	
41-19-08	<b>Voice Mail Delay Announcement – Delayed Message Interval Time</b> Set the time between Delayed Messages.	0 ~ 64800 seconds	20		✓	
47-03-02	<b>SV9100 InMail Group Mailbox Options – Mailbox Number</b> The Group Mailbox Number is the same as the Department Group master (pilot) number. Use this option to select the Department Group master (pilot) number associated with the Group Mailbox you are programming.	Digits (maximum of eight using 0 ~ 9) No Setting (entered by pressing <b>Hold</b> )	No Setting		✓	
47-03-03	<b>SV9100 InMail Group Mailbox Options – Mailbox Type</b> Set the Group Mailbox type.	0 = None 1 = Subscriber 2 = Routing	1		✓	

## Operation

### Calling Your Mailbox

#### To call your mailbox:

*With a multiline terminal, your Voice Mail key flashes green and your Message Center keys flash red when they have messages waiting. If you do not have a Voice Mail key, your Message Waiting LED flashes instead.*

#### Multiline Terminal

1. Press your **Voice Mail** key (Program 15-07 or SC 751: 01 + \*8).

- OR -

Press the **Vmsg** softkey.

- OR -

Press the **Message** key on the telephone, if equipped.

- ◇ *Your mailbox number is normally the same as your extension number. You may optionally dial a co-worker's mailbox - or use this procedure to call your mailbox from a co-worker's telephone.*

- OR -

Press **Speaker** and dial \*8.

2. If requested by Voice Mail, enter your security code.
  - ◇ *Ask your Voice Mail system administrator for your security code.*
  - ◇ *Normally, your Message Waiting (MW) LED goes out (if applicable). If it continues to flash, you have unanswered Message Waiting requests or a new General Message. See “To check your messages” below.*

### Single Line Telephone

1. Lift the handset and dial **\*8**.
  - ◇ *If you are at a co-worker’s telephone, you can dial the Voice Mail master number and your mailbox number instead. You can also use this procedure from your own telephone to call a co-worker’s mailbox.*
2. If requested by Voice Mail, enter your security code.

### Checking Messages

#### If Program 15-02-26 = 0 (Message Key):

1. Press the **Message** key once.
  - ◇ *The user can use the VOL UP and VOL DOWN keys to view the new messages. If there are both voice mail messages and Message Waiting calls, the display indicates the number of new voice mail messages and then each Message Waiting call is shown.*
  - ◇ *When there are new messages, the Message Waiting LED on the telephone will flash red.*
  - ◇ *To return a displayed Message Waiting, press the Speaker key or lift the handset.*
2. To return a displayed Message Waiting, press **Speaker** or lift the handset.

To listen to the voice messages, with Voice Message displayed, press **Speaker** or lift the handset.

  - ◇ *The voice mail is called.*
  - ◇ *The voice mail is only called if there are new messages. If the display indicates Check Messages No Messages, press the Exit key to return the telephone to idle.*

#### If Program 15-02-26 = 1 (Voice Mail Key):

1. Press the **Message** key once.
  - ◇ *The voice mail is called.*
  - ◇ *When there are new messages, the Message Waiting LED on the telephone flashes red.*
  - ◇ *With this option set, the MSG key can be used as a Voice Mail key for any function [calling voice mail or transfer call a to voice mail (Hold + MSG + Extension Number), etc.].*

## Leaving A Message (Multiline Terminal Only)

To leave a message in the mailbox of an unanswered extension (*the extension you call can be busy, in DND or unanswered*):

1. Press the **Voice Mail** key (Program 15-07 or SC 751: code 77 + InMail pilot).

- OR -

Press the **Message** key on telephone, if equipped.

- OR -

Dial **8**.

◇ *The Voice Mail System prompts you to leave a message.*

## Forwarding Calls to Your Mailbox

To activate or cancel Call Forwarding:

1. Press **Speaker** (or lift the handset at the single line telephone) and choose from the following dial access codes:  
741 = Call Forward – Immediate (Program 15-07 or SC 751: code 10)  
742 = Call Forward – Busy (Program 15-07 or SC 751: code 11)  
743 = Call Forward – No Answer (Program 15-07 or SC 751: code 12)  
744 = Call Forward – Busy/No Answer (Program 15-07 or SC 751: code 13)
2. Dial the Voice Mail master number.
3. Press **Speaker** to hang up (or hang up handset at the single line telephone).

## Transferring Calls to a Mailbox

To transfer your active call to a mailbox:

### Multiline Terminal

1. Press **Hold**.
2. Press the **Voice Mail** key (Program 15-07 or SC 751: code 77 + InMail pilot).  
- OR -  
Press the **Message** key on the telephone, if equipped.
3. Dial the number of mailbox to receive the transfer.  
◇ *This number can be a mailbox number or a co-worker's mailbox number.*  
- OR -

Press the **DSS Console** or **One-Touch** key for extension user's mailbox, which receives the transfer.

◇ *If the Transfer destination is an extension forwarded to Voice Mail, the call waits before routing the called user's mailbox. This gives you the option of retrieving the call instead of having it picked up by Voice Mail.*

4. Hang up.

◇ *Voice Mail prompts your caller to leave a message in the mailbox you selected.*

- OR -

1. Dial extension number or press a DSS Console key for the extension mailbox which receives the transfer.

2. Press the Voice Mail key (Program 15-07 or SC 751: code 77 + InMail pilot)

- OR -

Press the **Message** key on the telephone, if equipped.

3. Hang up.

◇ *Voice Mail prompts your caller to leave a message in the mailbox you selected.*

#### Single Line Telephone

1. Hookflash.

Dial Voice Mail master number followed by destination mailbox.

◇ *If the Transfer destination is an extension forwarded to Voice Mail, the call waits before routing the called user's mailbox. This gives you the option of retrieving the call instead of having it picked up by Voice Mail.*

2. Hang up.

## Recording Your Call

### To record your active call in your mailbox:

#### Multiline Terminal

1. Press the **Voice Mail Record** key (Program 15-07 or SC 751: code 78)

◇ *You hear a beep and your Record key flashes. The system beeps periodically to remind you that you are recording.*

◇ *To stop recording, press the Voice Mail Record key again. You can restart and stop recording as required.*

- OR -

1. Press **Hold**.

2. Dial **654**.

◇ *The system automatically reconnects you to your call.*

- ◇ *To stop recording, place the call on hold then pick the call back up. You can restart and stop recording as required.*

### Single Line Telephone

1. Hookflash.
2. Dial **654**.
  - ◇ *The system automatically reconnects you to your call.*
  - ◇ *To stop recording, hookflash twice. You can restart and stop recording as required.*

### Personal Answering Machine Emulation (Multiline Terminal Only)

#### To enable or cancel Personal Answering Machine Emulation:

1. Press **Speaker** (or lift the handset at the single line telephone) and choose from the following dial access codes:
  - 741 = Call Forward – Immediate
  - 742 = Call Forward – Busy
  - 743 = Call Forward – No Answer
  - 744 = Call Forward – Busy/No Answer
  - 745 = Call Forward – Both Ring
  - 746 = Call Forwarding – Follow Me
2. Dial the Voice Mail master number.
3. Press **Speaker** to hang up (or hang up handset at the single line telephone).

#### When Personal Answering Machine Emulation broadcasts your caller's message, you can:

*Your telephone must be idle (not on a call).*

1. Do nothing.
  - ◇ *The message is automatically being recorded in your mailbox. The broadcast stops when your caller hangs up.*

**- OR -**
1. Lift the handset to intercept the call.
  - ◇ *You connect to the caller. The system records the first part of the message in your mailbox. The line key changes from red to green.*

**- OR -**

Press **Speaker** to cut off the message broadcast and send the call to your mailbox.

  - ◇ *Voice Mail records the entire message in your mailbox.*



## Checking Your Messages (Multiline Terminal Only)

### To check your messages:

1. Press the **Message** key.
2. Dial **\*0**.
  - ◇ *You can have any combination of the message types in the table below on your telephone.*

If you see. . .	You have. . .
<b>VOICE MESSAGE n MESSAGES</b>	<b>New messages in your Voice Mail mailbox</b>
<b>CHECK MESSAGE VRS GENERAL MESSAGE</b>	<b>Not listened to the current General Message</b>
<b>CHECK MESSAGE (name)</b>	<b>Message Waiting requests left at your telephone by your co-workers</b>

3. Press VOL ▲ or VOL ▼ to scroll through your display.
4. When you find the message you want to answer, press **Speaker**. You can either:
  - Go to your Voice Mail mailbox.
  - Listen to the new General Message.
  - Automatically call the extension that left you a Message Waiting.

## Directory Dialing

### Recording a Directory Dialing message:

1. Log onto the System Administrator’s mailbox: **SA** (72) or press **0** to play a Help message.
2. Select Instruction Menus: **I** (4).
3. Enter the Directory Dialing Mailbox number or press **#** to go back to the System Administrator Options.
4. Select one of the following options:
  - L** (5) = Listen to the current Directory Dialing Message (if any)
  - #** = Exit listen mode
  - R** (7) = Record a new Directory Dialing Message
    - **\*** = Pause or restart recording
    - **E** (3) = Erase recording
    - **#** = Exit recording mode
  - E** (3) = Erase the Directory Dialing Message
  - #** = Go back to the System Administrator options

**Using Directory Dialing:**

1. After the Automated Attendant answers, wait for the Directory Dialing Message. The Automated Attendant may ask you to dial a digit for Directory Dialing.
2. Dial the letters that correspond to the name of the person you wish to reach + #.
  - The Directory Dialing Message tells you how many letters you need to dial, and whether you should enter the person's first name or last name.
  - To exit Directory Dialing without selecting a name, dial #.
3. The Automated Attendant announces the name matches, and tells you which digit to dial (1~3) to reach each of the announced names.
  - To hear additional name matches (if any), dial 6 instead.
4. After you make your selection, the Automated Attendant routes your call to the name you select.

## InMail – Automatic Access to VM by Caller ID

### Description

Before, when a user outside the system accessed their InMail mailbox, they dialed voice mail, then entered an access code followed by their mailbox number and password (if enabled). An InMail mailbox can be associated with a specific caller ID (CID) number. When the CID number is presented to the InMail it will automatically log the user into their mailbox. This enhancement improves VM accessibility for outside callers, allowing them to simply dial the main voice mail number and be automatically logged into their mailbox.

Two types of voice mail access modes exist for this feature.

1. Specifying the VM Pilot number as a DID/DIL/DISA/VRS destination.
  - OR -
  - Dialing the VM pilot number after calling in from a Mobile Extension.
2. Program to forward a call to VM (102) by any of following Programs.
  - Program 22-05-01 (Incoming Ring Group)
  - Program 22-11-05 (Transfer Target number -1)
  - Program 22-11-06 (Transfer Target number -2)
  - Program 25-03-01 (Incoming Ring Group No.)
  - Program 25-04-01 (VRS/DISA Transfer Ring Group at No answer/Busy)

Figure 2-27 Example – User Access to Voice Mail

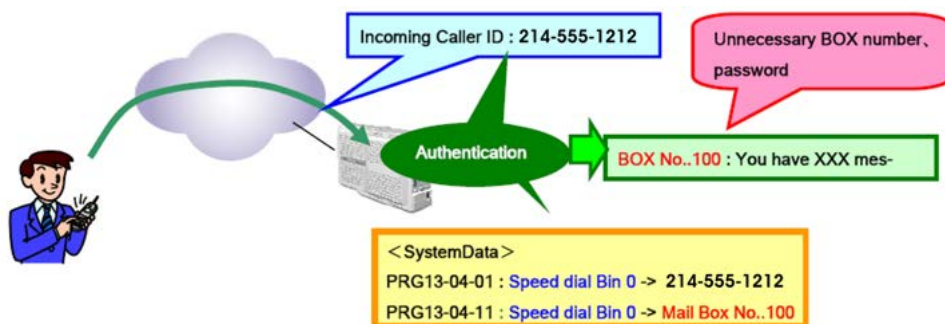

### Conditions

- When using this feature the InMail does not prompt for a password on a call from the set CID number.
- Incoming calls across CCIS are not supported.

- Two different mailboxes can not be tied to the same inbound CID number. If two mailboxes are set for the same inbound CID number the system uses the first match it finds.
- To use this feature, the phone number must be set in Program 13-04-01 and the voice mail box number in Program 13-04-11. If both are not set, the system requires the normal log in procedure of entering a valid mailbox number and security code to login.
- This feature is only supported for external calls to the InMail.
- Mobile Extension users can use this feature by setting the VM box number in Program 13-04-11 which corresponds to the Speed Dial number registered in Program 15-22-01.
- Common Speed Dial area is used for this feature. Group or Station Speed Dial areas are not supported with this feature.
- When a number in the Common Speed Dial includes a trunk access code or end code (#), the Redial name indication will work if the number matches completely.
- If the same number is registered in the Common Speed Dial bin, the latest Speed Dial number is used.
- The Flexible ringing feature has priority over the InMail – Automatic Access to VM by Caller ID feature.
- The UM8000 does not support setting this feature in SV9100 system programming. To set this feature for the UM8000, refer to the on line UM8000 system administration guide.
- To enable this feature, Program 14-01-22 (Caller ID to Voice Mail) must be set to 1.

## Default Settings

Disabled

## System Availability

### Terminals

All Multiline Terminals

### Trunks

The following Trunks support sending Caller ID:

- Analog Line
- ISDN Line (BRI)
- ISDN Line (PRI)
- SIP Line
- H.323 Line

Required Component(s)

- 1012 – SV9100 InMail VM Box Lic
- 0411 – SV9100 Version Lic (R4)

Related Features

- ↳ **Caller ID – Flexible Ringing**
- ↳ **Mobile Extension**
- ↳ **Speed Dial – System/Group/Station**
- ↳ **InMail**

Guide to Feature Programming

The **Level 1**, **Level 2** and **Level 3** columns indicate the programs that are assigned when programming this feature in the order they are most commonly used. These levels are used with PCPro and WebPro wizards for feature programming.

- Level 1 – these are the most commonly assigned programs for this feature.
- Level 2 – these are the next most commonly assigned programs for this feature.
- Level 3 – these programs are not often assigned and require an expert level working knowledge of the system to be properly assigned.

Program Number	Program Name/Description	Input Data	Default	Level		
				1	2	3
13-04-01	<b>Speed Dialing Number and Name – Speed Dialing Data</b> This program stores Speed Dial data into the Speed Dial areas, and defines the Speed Dial names.	Maximum of 24 digits (0 ~ 9, *, #, @, P, R) @ = Wait for Answer Supervision - ISDN trunks only P = Pause - Analog Trunk Only R = Hook flash - Analog Trunk Only	No Setting	✓		
13-04-02	<b>Speed Dialing Number and Name – Name</b> Assign a name to each System Speed Dial bin.	Maximum of 12 Characters (Use dial pad to enter name).	No Setting		✓	
13-04-11	<b>Speed Dialing Number and Name – Automatic Access to Voice Mail by Caller ID</b> Per Speed dial Bin No. (0000-9999), set the VM BOX number (0 ~ 896). Incoming Caller ID number will be checked against Speed Dial data (Program 13-04-01). From matched Speed Dial Bin No, system then finds the associated VM Box number with this Program.	Mailbox Number 0 ~ 896, 900 ~ 931	0	✓		

Program Number	Program Name/Description	Input Data	Default	Level		
				1	2	3
14-01-22	<b>Basic Trunk Data Setup – Caller ID to Voice Mail</b> Enable/Disable the system ability to send the Caller ID digits to voice mail.	Trunks 1 ~ 400 0 = Disable 1 = Enable	0	✓		
15-22-01	<b>Mobile Extension Setup – Mobile Extension Target Setup</b> For each Mobile Extension number, select the Abbreviated Dial bin number to be associated with it. When using this feature with Mobile Extension, set the associated VM Box number in Program 13-04-11. The incoming Extension number will be checked with Program 15-22-01. From matched Speed Dial Bin No, system finds the VM Box number with Program 13-04-11.	0 ~ 9999 (0 = No setting 1 ~ 9999 = target of mobile extension)	0	✓		
22-02-01	<b>Incoming Call Trunk Setup</b> Assign the incoming trunk type for each trunk.	Incoming Type for Day/Night Mode (1 ~ 8): 0 = Normal 1 = VRS (second dial tone if no VRS installed) 2 = DISA 3 = DID 4 = DIL 5 = E&M Tie line 6 = Delayed VRS 7 = ANI/DNIS 8 = DID(DDI) Mode Switching	0		✓	
22-05-01	<b>Incoming Trunk Ring Group Assignment</b> Assign trunks to incoming Ring Groups. Use this program to assign Normal Ring Trunks (Program 22-02) to Incoming Ring Groups (Program 22-04). It sets arriving group of the outside line set by Program 22-02 as "General arrival call".	Trunks 1 ~ 400 Incoming Group Number for Day/Night Mode (1 ~ 8): 0 = (No Setting) 001 ~ 100 = (Incoming Group) 102 = (In-Skin/ External Voice Mail or InMail)	1		✓	
22-11-05	<b>DID Translation Table Number Conversion – Transfer Destination Number 1</b> For each DID Translation Table entry (1 ~ 4000), specify the first and second Transfer Destinations if the callers receives a busy or no answer (action defined in Program 22-11-04). ➤ <i>If the Transfer Destinations are busy or receive no answer, those calls are transferred to the final transfer destination (Program 22-10).</i>	0 = No Setting 1 ~ 100 = Incoming Group 101 = (Not Used) 102 = In-Skin/External Voice Mail or InMail 201~264 = Department Group 400 = DUD 401 = DISA 501 ~ 599 = DISA/VRS Message 1000 ~ 1999 = Speed Number (000 ~ 999)	0	✓		

Program Number	Program Name/Description	Input Data	Default	Level		
				1	2	3
22-11-06	<p><b>DID Translation Table Number Conversion – Transfer Destination Number 2</b></p> <p>For each DID Translation Table entry (1 ~ 4000), specify the first and second Transfer Destinations if the callers receives a busy or no answer (action defined in Program 22-11-04).</p> <p>➡ <i>If the Transfer Destinations are busy or receive no answer, those calls are transferred to the final transfer destination (Program 22-10).</i></p>	0 = No Setting 1 ~ 1 00 = Incoming Group 101 = (Not Used) 102 = In-Skin/External Voice Mail or InMail 201~264 = Department Group 400 = DUD 401 = DISA 501 ~ 599 = DISA/VRS Message 1000 ~ 1999 = Speed Number (000 ~ 999)	0	✓		
25-03-01	<p><b>VRS/DISA Transfer Ring Group With Incorrect Dialing</b></p> <p>For each trunk port, set what happens to a call when the DISA or Automated Attendant caller dials incorrectly or waits too long to dial. The call can either disconnect (0) or Transfer to an alternate destination (a ring group, In-Skin/External, Centralized). When setting the DISA and DID Operating Mode, you make an entry for each Night Service mode.</p> <p>This program defines the Incoming Ring Group when dial tone is timed-out or the wrong dialing is received in DID, DISA.</p>	Ring Groups: 1 ~ 100 Trunk Ports: 001 ~ 400 Day/Night Mode: 1 ~ 8 0 = Disconnect 1 ~ 100 = Incoming Ring Group 101 = DSPDB-VM 102 = In-Skin/External Voice Mail or InMail 104 = Speed Dial Bin (table Program 25-15-01)	0		✓	
25-04-01	<p><b>VRS/DISA Transfer Ring Group With No Answer/Busy</b></p> <p>For each trunk port (001 ~ 400), set the operating mode of each DISA trunk. This sets what happens to the call when the DISA or Automated Attendant caller calls a busy or unanswered extension. The call can either disconnect (0) or Transfer to an alternate destination (a ring group, In-Skin/External, Centralized). When setting the DISA and DID Operating Mode, you make an entry for each Night Service mode.</p> <p>This program defines the Incoming Ring Group when Target extension has no answer or is busy in DID.</p>	Ring Groups: 1 ~ 100 Trunk Ports: 001 ~ 400 Day/Night Mode: 1 ~ 8 0 (Disconnect) 1 ~ 100 (Incoming Ring Group) 101 DSPDB-VM 102 (In-Skin/External Voice Mail or InMail) 104 (Speed Dial table Program 25-15-01)	0		✓	

## Operation

### Retrieve VM Messages

#### To retrieve VM messages from outside of office:

If incoming analog trunks are used in the system:

Main Number: 214-555-5678

Outside party number: 214-555-1212

- Program 22-02-01: Trunk 1 DIL
- Program 22-07-01: VM Pilot number, 200
- Program 13-04-01: Speed Dial area No.0 -> 2145551212
- Program 13-04-11: Speed Dial area No.0 -> 001 (VM BOX number, not extension number)
  1. Call the main number from 214-555-1212.
  2. After the VM answers the user can listen to and manage voice messages or change mailbox settings.

If incoming DID trunks are used in the system:

Main Number: 214-555-5678

Outside party number: 214-555-1212

- Program 22-02-01: Trunk 1 DID
- Program 22-11-05: Set transfer destination, 102 InMail
- Program 13-04-01: Speed Dial area No.0 -> 2145551212
- Program 13-04-11: Speed Dial area No.0 -> 001 (VM BOX number, not extension number)
  1. Call the main number from 214-555-1212.
  2. After the VM answers the user can listen to and manage voice messages or change mailbox settings.



## *InMail – Cascade Message Notification*

### Description

If an extension user receives a new message in their mailbox, Cascading Message Notification will call them at up to five preset destinations to let them know a new voice mail message has arrived. A destination can be an outside number (such as a cell phone, pager, or home office) or a co-worker's extension.

The Cascading Message Notification destinations are set up in the Notification Schedule. Each of the five schedule entries can be individually enabled or disabled and provides options for:

- Type: Voice call or pager.
- Start Hour: The time the destinations become active.
- End Hour: The time the destinations become inactive.
- Number: The destination telephone, pager, or extension number.
- Busy Attempts: The number of times the system will try the destination when it is busy. The system cancels notification callouts for this entry when the Busy Attempts number is met.
- RNA Attempts: The number of times the system will try the destination when it is unanswered. The system cancels notification callouts for this entry when the RNA Attempts number is met.
- Security: Enables or disables the Security Code requirement for the notification destinations. For example, you may want to disable the Security Code when the destinations is your cell phone and it may be inconvenient to dial digits after answering the notification callout.

When the extension user enables Cascading Message Notification, the system will try each enabled destination that is active for the current day and time (i.e., in-schedule). The system will not try any destinations that are disabled or are not in-schedule. When the retries for a particular destination have been met the system will immediately move to the next destination.

With SV9100 software, each mailbox can be set to queue notification options. When this feature is enabled, messages received when destinations are not in-schedule are queued until a destination is in-schedule at which time the notification process will start.

### Conditions

- When a mailbox has a new message and the message is deleted using the User Pro interface, the MWI of the mailbox is turned off but Message Notification is not cancelled.
- The Message Notification Queue feature can be changed using system programming only.
- The Message Notification Queue feature is set on a per mailbox basis.
- Retry Interval timers are set on a system wide basis only.
- The pager dial string is set on a system wide basis only.

- Notification settings can be changed using the Telephone Mailbox Option Interface or system programming only.
- When the retries for a particular destination have been met the system will immediately move to the next destination even if there is only one destination active.
- Once the notification process begins, a new message does not restart the process if it is already in progress. Once the process ends (e.g., if the message is acknowledged or the maximum number of callout attempts is reached), the next new message will restart the process.
- The system determines which numbers are internal extensions or external numbers by the system dial plan settings.
- Depending on the system ARS routing maybe needed to properly route external calls.
- If no trunks are available when an outside destination is attempted it is counted as a Busy No Answer attempt.
- Program 47-02-28 is used to enable or disable message notification queuing. If enabled, message notification is stored in queue when there is no active notification destination. Once the destination becomes active the queued notification is processed.

Figure 2-28 Cascade Message Notification Flow Chart-1

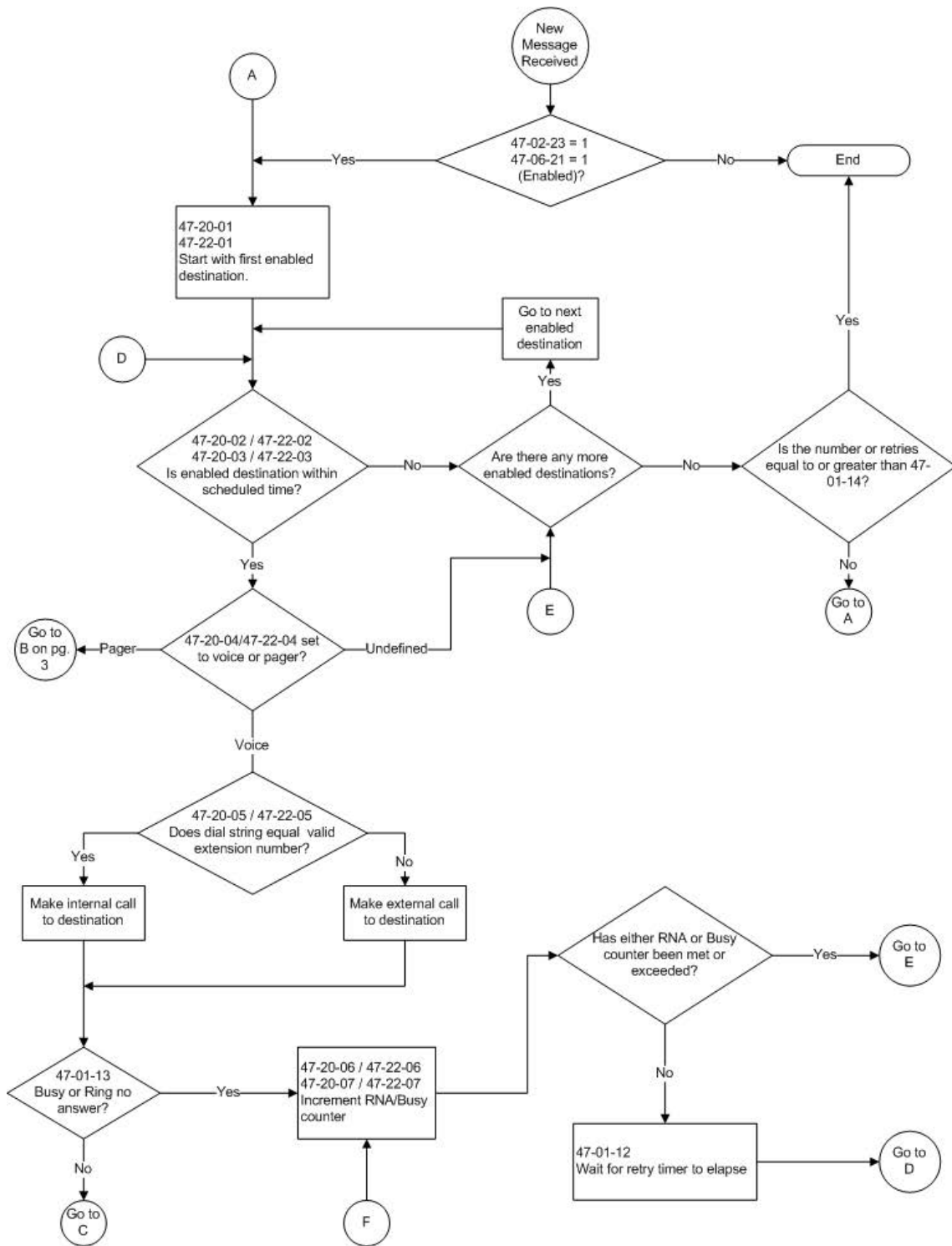

Figure 2-29 Cascade Message Notification Flow Chart-2

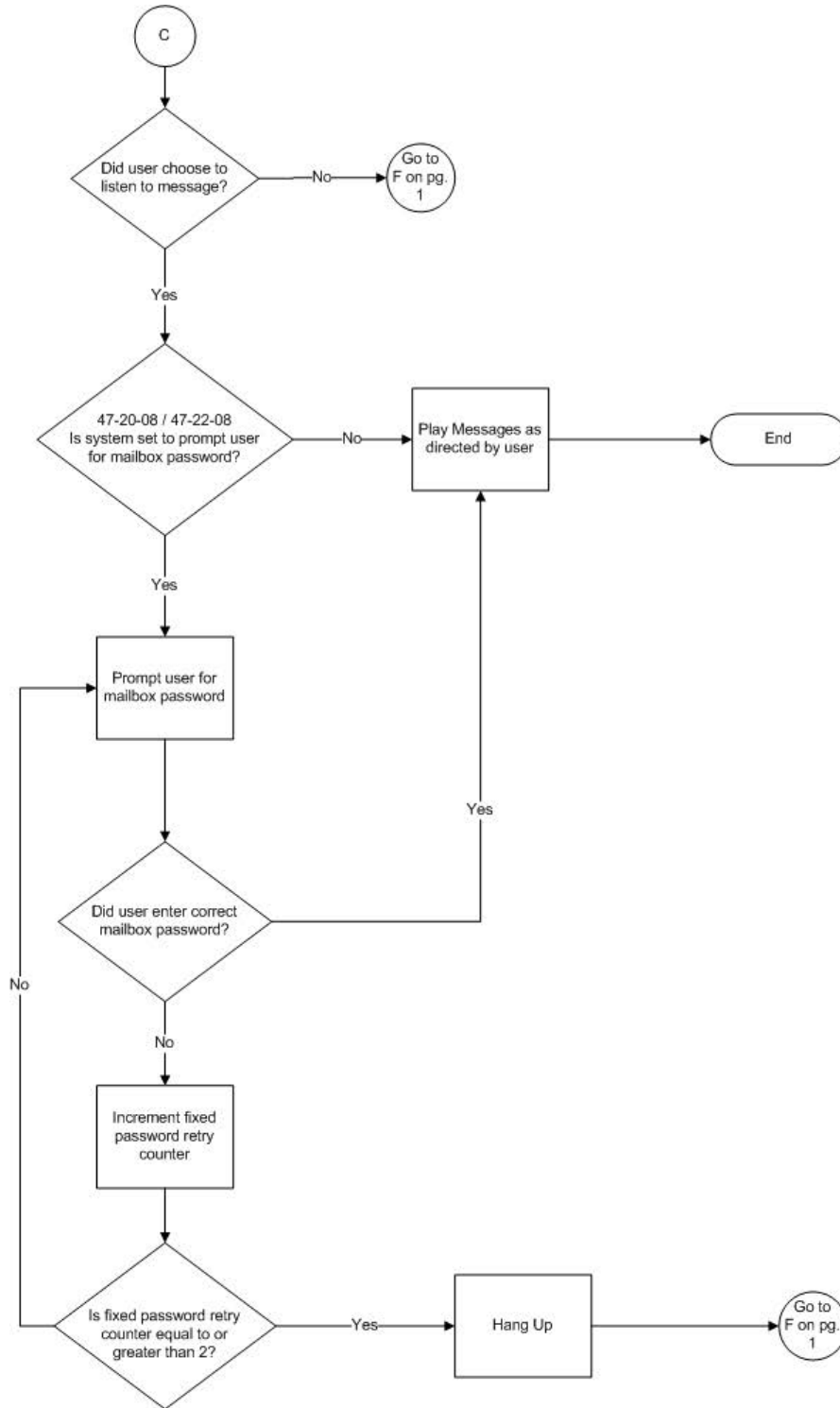
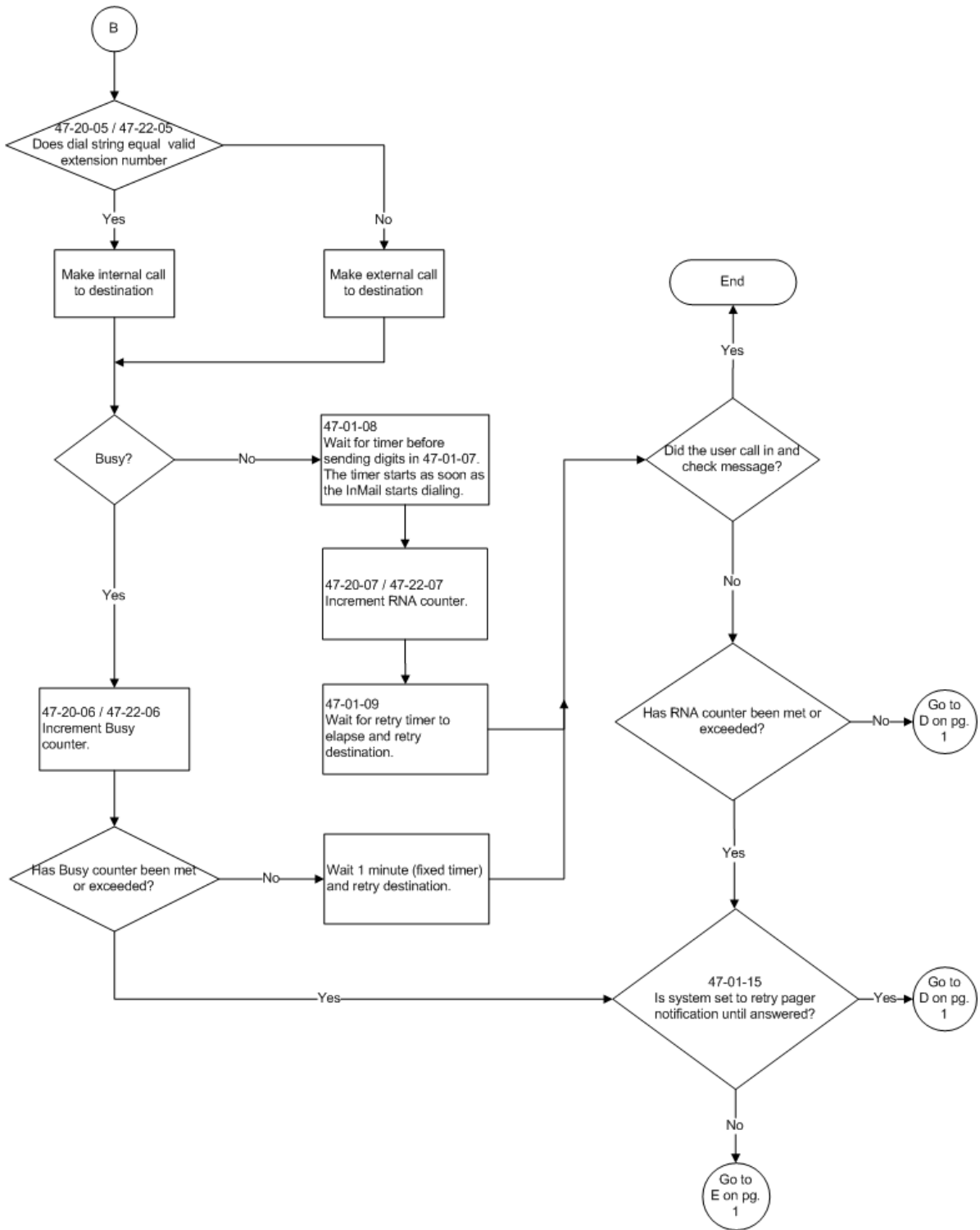

Figure 2-30 Cascade Message Notification Flow Chart-3



## Message Notification to Normal Telephone Numbers

This is a basic overview of how Message Notification works to phone numbers assuming the retry attempts are at default. The system determines which numbers are internal extensions or external numbers by the system dial plan settings. Depending on the system, ARS routing maybe needed to properly route external calls.

1. The subscriber activates Message Notification for their mailbox.
2. When the subscriber receives a new message, the InMail dials the first active destination in the cascade that should receive the Message Notification.
  - InMail waits up to 30 seconds (approximately five rings) for ringback, reorder, busy or voice activity from the called number. If nothing is detected, the callout is considered unanswered (RNA).
3. If the recipient answers, InMail plays the notification message (“Hello, I have a message for”) and asks the recipient to dial 1 to log onto their mailbox. The recipient hears the notification message if:
  - They say “Hello” after answering the callout, or
  - The system receives answer supervision from the telco after the recipient answers the call. (Note that the recipient can skip the announcement by dialing 1 to log onto their mailbox after answering the callout – without saying “Hello”)., or
  - The notification is to a system extension.
4. Once the recipient logs onto the mailbox, the notification is considered acknowledged and will not reoccur until the subscriber receives new messages.
5. If the recipient doesn’t answer, the system follows the Cascading Message Notification retry attempt settings and notification will eventually stop if the call is not answered.
6. Once the notification process begins, a new message does not restart the process if it is already in progress. Once the process ends (e.g., if the message is acknowledged or the maximum number of callout attempts is reached), the next new message will restart the process.

## Message Notification to Pager Numbers

This a basic overview of how Message Notification works to pager numbers assuming the retry attempts are at default. The system determines which numbers are internal extensions or external numbers by the system dial plan settings. Depending on the system, ARS routing maybe needed to properly route external calls.

1. The subscriber activates Message Notification for their mailbox.
2. When the subscriber receives a new message, InMail immediately dials the pager service.
  - InMail waits up to 30 seconds (approximately five rings) for ringback, reorder, busy or voice activity from the called number. If nothing is detected, the callout is considered unanswered.
3. After the pager service answers, InMail waits for the timer 47-01-08 then sends the dial string in 47-01-07 which causes the pager display to show the subscriber’s mailbox number as well as the number of new messages in the mailbox.

- The notification is considered acknowledged if the subscriber logs onto their mailbox.
- If the notification is not acknowledged (within a programmable time frame, 47-01-12) the pager notification is repeated (up to the RNA attempts count, 47-20-07).
- If the pager service doesn't answer, the system follows the Cascading Message Notification rules and notification will eventually stop if the call is not answered.

## Default Settings

None

## System Availability

### Terminals

All Multiline Terminals

### Required Component(s)

- 1012 – SV9100 InMail VM Box Lic
- 0411 – SV9100 Version Lic (R1)

## Related Features

None

## Guide to Feature Programming

The **Level 1**, **Level 2** and **Level 3** columns indicate the programs that are assigned when programming this feature in the order they are most commonly used. These levels are used with PCPro and WebPro wizards for feature programming.

- Level 1 – these are the most commonly assigned programs for this feature.
- Level 2 – these are the next most commonly assigned programs for this feature.
- Level 3 – these programs are not often assigned and require an expert level working knowledge of the system to be properly assigned.

Program Number	Program Name/Description	Input Data	Default	Level		
				1	2	3
47-01-07	<p><b>SV9100 InMail System Options – Digital Pager Callback Number</b></p> <p>Set the <i>Digital Pager Callback Number</i> part of the message Notification callout number for a digital pager. This part of the callout number is appended to the pager service telephone number. Normally, this option should be <b>X*M#</b>, where</p> <ul style="list-style-type: none"> <li>○ <b>X</b> is the number of the extension that generated the notification.</li> <li>○ <b>*</b> is a visual delimiter (to make the pager display easier to read).</li> <li>○ <b>M</b> is the number of new messages in the extension mailbox.</li> <li>○ <b>#</b> is the digit normally used by the pager service for positive disconnect.</li> </ul>	<p><b>Digits</b> (12 maximum, using 0 ~ 9, # and *)</p> <p><b>M</b> (Number of messages – entered by pressing <b>LK1</b>)</p> <p><b>No entry</b> (Entered by pressing <b>HOLD</b>).</p> <p><b>X</b> (Extension number – entered by pressing <b>LK2</b>) InMail automatically replaces the X command with the number of the extension that initially received the message.</p>	X*M#		✓	
47-01-08	<p><b>SV9100 InMail System Options – Delay in Dialing Digital Pager Callback Number</b></p> <p>Set the delay that occurs just before SV9100 InMail dials the Digital Pager Callback Number portion of the Message Notification callout number for a digital pager. Set this delay so the pager service has enough time to connect to the digital pager before sending the callback number.</p>	0 ~ 99 seconds	30		✓	
47-01-09	<p><b>SV9100 InMail System Options – Wait Between Digital Pager Callout Attempts</b></p> <p>Use this option to set the minimum time (1 ~ 255 minutes) between unacknowledged or unanswered digital pager Message Notification callouts. (A subscriber acknowledges a digital pager notification by logging onto their mailbox.) After this interval expires, InMail will try the callout again.</p>	1 ~ 255 minutes	15		✓	
47-01-11	<p><b>SV9100 InMail System Options – Wait Between Busy Non-Pager Callout Attempts</b></p> <p>Callout Attempts (Notify Busy Intvl)</p> <p>Set the time SV9100 InMail waits after it dials a busy non-pager callout destination, before retrying the callout number.</p>	1 ~ 255 minutes	15		✓	
47-01-12	<p><b>SV9100 InMail System Options – Wait Between RNA Non-Pager Callout Attempts</b></p> <p>Wait Between RNA Non-Pager Callout Attempts (Notify RNA Intvl) Set the time SV9100 InMail waits, after it dials an unanswered non-pager callout destination, before retrying the callout number.</p>	1 ~ 255 minutes	30		✓	



Program Number	Program Name/Description	Input Data	Default	Level		
				1	2	3
47-01-13	<p><b>SV9100 InMail System Options – Number of RNA Rings</b></p> <p>Wait for Answer Non-Pager Callout Attempts (Notify RNA Rings)</p> <p>If a non-pager callout rings the destination longer than this number of rings, SV9100 InMail marks the call as unanswered (Ring No Answer) and hangs up.</p>	1 ~ 99 (rings)	5		✓	
47-01-14	<p><b>SV9100 InMail System Options – Number of Cascading Attempts</b></p> <p>Notify Call Attempt</p> <p>With Cascade Pager Notification: Set how many times a mailboxes enabled pager notification destinations are tried. For example if 47-01-14 is set to 10 and a mailbox has 5 enabled pager destinations and each destination has three retries for BNA/RNA (47-20-06 and 47-20-07). The InMail will call each destination three times and will retry all the enabled destinations 10 times. This means each enabled destination will be called a total of 30 times (10 x 3). With Normal Pager Notification Set how many attempts SV9100 InMail retries an incomplete Message Notification callout. This total includes unacknowledged callouts, callouts to a busy destination, and callouts to an unanswered destination. This option applies to pager and non-pager callouts.</p>	1 ~ 99 (rings)	1	✓		
47-02-23	<p><b>SV9100 InMail Station Mailbox Options – All Message Notification Enabled</b></p> <p>Use this option to enable or disable notification for the subscriber mailbox. If disabled, enabling the individual notification entries has no effect.</p>	0 = Disabled 1 = Enabled	1		✓	
47-02-28	<p><b>SV9100 InMail Station Mailbox Options – Message Notification Queuing Option</b></p> <p>Use this option to enable or disable message notification queuing. If enabled, message notification is stored in queue when there is no active notification destination. Once the destination becomes active the queued notification is processed.</p>	0 = Disabled 1 = Enabled	0		✓	
47-06-21	<p><b>Group Mailbox Subscriber Options – All Message Notification Enabled</b></p> <p>Use this option to enable or disable notification for the group mailbox. If disabled, enabling the individual notification entries has no effect.</p>	0 = Disabled 1 = Enabled	1		✓	

Program Number	Program Name/Description	Input Data	Default	Level		
				1	2	3
47-06-26	<p><b>Group Mailbox Subscriber Options – Message Notification Queuing Option</b></p> <p>Use this option to enable or disable message notification queuing. If enabled, message notification is stored in queue when there is no active notification destination.</p>	0 = Disabled 1 = Enabled	0		✓	
47-20-01	<p><b>Station Mailbox Message Notification – Notification</b></p> <p>For the selected entry (1-5), use this option to enable or disable Message Notification. If enabled, notification will occur when the mailbox receives a new message according to the settings for Type, Start Hour, End Hour, and notification Phone Number. If disabled, Message Notification will not occur.</p> <p>➤ <i>There are five separately programmed Message notification entries for each Subscriber Mailbox.</i></p>	0 = Disabled 1 = Enabled	0	✓		
47-20-02	<p><b>Station Mailbox Message Notification – Notification Begin Hour</b></p> <p>For the selected entry (1-5), use this option to set the hour when Message Notification will start. Notification will occur only for new messages received between this setting and the End Hour setting. This entry is in 24-hour (military time). For example, 08 is 8:00 AM and 20 is 8:00 PM. For 24-hour notification, make the Start Hour the same as the End Hour.</p> <p>➤ <i>There are five separately programmed Message notification entries for each Subscriber Mailbox.</i></p>	0 ~ 23 (24 Hour Clock)	0	✓		
47-20-03	<p><b>Station Mailbox Message Notification – Notification End Hour</b></p> <p>For the selected entry (1-5), use this option to set the hour when Message Notification will stop. Notification will occur only for new messages received between the Start Hour and this setting. This entry is in 24-hour (military time). For example, 08 is 8:00 AM and 20 is 8:00 PM. For 24-hour notification, make the Start Hour the same as the End Hour.</p> <p>➤ <i>There are five separately programmed Message notification entries for each Subscriber Mailbox.</i></p>	0 ~ 23 (24 Hour Clock)	0	✓		
47-20-04	<p><b>Station Mailbox Message Notification – Notification Type</b></p> <p>For the selected entry (1-5), use this option to set the Message Notification type. The choices are Voice and Pager. Choose Voice when the Phone Number entry is to a regular office, home, or mobile telephone. Choose Pager when you want to deliver the notification to a digital pager.</p> <p>➤ <i>There are five separately programmed Message notification entries for each Subscriber Mailbox.</i></p>	0 = Undefined 1 = Voice 2 = Pager	1	✓		

Program Number	Program Name/Description	Input Data	Default	Level		
				1	2	3
47-20-05	<p><b>Station Mailbox Message Notification – Notification Number</b></p> <p>For the selected entry (1-5), use this option to set the telephone number (16 digits maximum) Message Notification will dial to notify the subscriber of new messages. Enter the number exactly as you want the system to dial it (including a leading 1 for toll calls, if required), but do not include a line access code (such as 9). If the number you enter is extension number, it will be an Intercom call. Otherwise, it will be an outside call. (The system decides by referring its numbering plan.)</p> <p>➤ <i>There are five separately programmed Message notification entries for each Subscriber Mailbox.</i></p>	Valid number (maximum of 16 digits).	No Setting	✓		
47-20-06	<p><b>Station Mailbox Message Notification – Notification Busy Attempts</b></p> <p>For the selected entry (1-5), use this option to set how many times InMail will retry an incomplete Message Notification callout to a busy destination. This option applies to pager and non-pager callouts. If the Busy Attempts and RNA Attempts are both met, the notification callout to the selected entry is cancelled.</p> <p>➤ <i>There are five separately programmed Message notification entries for each Subscriber Mailbox.</i></p>	1 ~ 99 Attempts	5	✓		
47-20-07	<p><b>Station Mailbox Message Notification – Notification RNA Attempts</b></p> <p>For the selected entry (1-5), use this option to set how many times InMail will retry an incomplete Message Notification callout when the destination does not answer. This option applies to pager and non-pager callouts. If the Busy Attempts and RNA Attempts are both met, the notification callout to the selected entry is cancelled.</p> <p>➤ <i>There are five separately programmed Message notification entries for each Subscriber Mailbox.</i></p>	1 ~ 99 Attempts	5	✓		
47-20-08	<p><b>Station Mailbox Message Notification – Notification Security</b></p> <p>For the selected entry (1-5), use this option to enable or disable Security Code protection for the callout. If enabled, the user is required to enter their security in order to log on and hear the new message. If disabled, the Security Code is not required.</p> <p>➤ <i>There are five separately programmed Message notification entries for each Subscriber Mailbox.</i></p>	0 = Security code not required 1 - Security code required	1	✓		

Program Number	Program Name/Description	Input Data	Default	Level		
				1	2	3
47-20-09	<p><b>Station Mailbox Message Notification – Day of Week Sunday</b></p> <p>For the selected entry (1-5), use this option to enable or disable Message Notification on Sunday.</p> <p>➤ <i>There are five separately programmed Message notification entries for each Subscriber Mailbox.</i></p>	0 = Disabled 1 = Enabled	1		✓	
47-20-10	<p><b>Station Mailbox Message Notification – Day of Week Monday</b></p> <p>For the selected entry (1-5), use this option to enable or disable Message Notification on Monday.</p> <p>➤ <i>There are five separately programmed Message notification entries for each Subscriber Mailbox.</i></p>	0 = Disabled 1 = Enabled	1		✓	
47-20-11	<p><b>Station Mailbox Message Notification – Day of Week Tuesday</b></p> <p>For the selected entry (1-5), use this option to enable or disable Message Notification on Tuesday.</p> <p>➤ <i>There are five separately programmed Message notification entries for each Subscriber Mailbox.</i></p>	0 = Disabled 1 = Enabled	1		✓	
47-20-12	<p><b>Station Mailbox Message Notification – Day of Week Wednesday</b></p> <p>For the selected entry (1-5), use this option to enable or disable Message Notification on Wednesday.</p> <p>➤ <i>There are five separately programmed Message notification entries for each Subscriber Mailbox.</i></p>	0 = Disabled 1 = Enabled	1		✓	
47-20-13	<p><b>Station Mailbox Message Notification – Day of Week Thursday</b></p> <p>For the selected entry (1-5), use this option to enable or disable Message Notification on Thursday.</p> <p>➤ <i>There are five separately programmed Message notification entries for each Subscriber Mailbox.</i></p>	0 = Disabled 1 = Enabled	1		✓	
47-20-14	<p><b>Station Mailbox Message Notification – Day of Week Friday</b></p> <p>For the selected entry (1-5), use this option to enable or disable Message Notification on Friday.</p> <p>➤ <i>There are five separately programmed Message notification entries for each Subscriber Mailbox.</i></p>	0 = Disabled 1 = Enabled	1		✓	
47-20-15	<p><b>Station Mailbox Message Notification – Day of Week Saturday</b></p> <p>For the selected entry (1-5), use this option to enable or disable Message Notification on Saturday.</p> <p>➤ <i>There are five separately programmed Message notification entries for each Subscriber Mailbox.</i></p>	0 = Disabled 1 = Enabled	1		✓	

Program Number	Program Name/Description	Input Data	Default	Level		
				1	2	3
47-22-01	<p><b>Group Mailbox Notification Options – Notification</b></p> <p>For the selected entry (1-5), use this option to enable or disable Message Notification. If enabled, notification will occur when the mailbox receives a new message according to the settings for Type, Start Hour, End Hour, and notification Phone Number. If disabled, Message Notification will not occur.</p> <p>➤ <i>There are five separately programmed Message notification entries for each Group Mailbox.</i></p>	<p>0 = Disabled 1 = Enabled</p>	0		✓	
47-22-02	<p><b>Group Mailbox Notification Options – Notification Begin Hour</b></p> <p>For the selected entry (1-5), use this option to set the hour when Message Notification will start. Notification will occur only for new messages received between this setting and the End Hour setting. This entry is in 24-hour (military time). For example, 08 is 8:00 AM and 20 is 8:00 PM. For 24-hour notification, make the Start Hour the same as the End Hour.</p> <p>➤ <i>There are five separately programmed Message notification entries for each Group Mailbox.</i></p>	0 ~ 23 (24 Hour Clock)	0		✓	
47-22-03	<p><b>Group Mailbox Notification Options – Notification End Hour</b></p> <p>For the selected entry (1-5), use this option to set the hour when Message Notification will stop. Notification will occur only for new messages received between the Start Hour and this setting. This entry is in 24-hour (military time). For example, 08 is 8:00 AM and 20 is 8:00 PM. For 24-hour notification, make the Start Hour the same as the End Hour.</p> <p>➤ <i>There are five separately programmed Message notification entries for each Group Mailbox.</i></p>	0 ~ 23 (24 Hour Clock)	0		✓	
47-22-04	<p><b>Group Mailbox Notification Options – Notification Type</b></p> <p>For the selected entry (1-5), use this option to set the Message Notification type. The choices are Voice and Pager. Choose Voice when the Phone Number entry is to a regular office, home, or mobile telephone. Choose Pager when you want to deliver the notification to a digital pager.</p> <p>➤ <i>There are five separately programmed Message notification entries for each Group Mailbox.</i></p>	<p>0 = Undefined (Disabled) 1 = Voice 2 = Pager</p>	1		✓	

Program Number	Program Name/Description	Input Data	Default	Level		
				1	2	3
47-22-05	<p><b>Group Mailbox Notification Options – Notification Number</b></p> <p>For the selected entry (1-5), use this option to set the telephone number (16 digits maximum) Message Notification will dial to notify the subscriber of new messages. Enter the number exactly as you want the system to dial it (including a leading 1 for toll calls, if required), but do not include a line access code (such as 9). If the number you enter is extension number, it will be an Intercom call. Otherwise, it will be an outside call. (The system decides by referring its numbering plan.)</p> <p>➤ <i>There are five separately programmed Message notification entries for each Group Mailbox.</i></p>	Valid number (maximum of 16 digits)	No Setting		✓	
47-22-06	<p><b>Group Mailbox Notification Options – Notification Busy Attempts</b></p> <p>For the selected entry (1-5), use this option to set how many times InMail will retry an incomplete Message Notification callout to a busy destination. This option applies to pager and non-pager callouts. If the Busy Attempts and RNA Attempts are both met, the notification callout to the selected entry is cancelled.</p> <p>➤ <i>There are five separately programmed Message notification entries for each Group Mailbox.</i></p>	1 ~ 99 Attempts	5		✓	
47-22-07	<p><b>Group Mailbox Notification Options – Notification RNA Attempts</b></p> <p>For the selected entry (1-5), use this option to set how many times InMail will retry an incomplete Message Notification callout when the destination does not answer. This option applies to pager and non-pager callouts. If the Busy Attempts and RNA Attempts are both met, the notification callout to the selected entry is cancelled.</p> <p>➤ <i>There are five separately programmed Message notification entries for each Group Mailbox.</i></p>	1 ~ 99 Attempts	5		✓	
47-22-08	<p><b>Group Mailbox Notification Options – Notification Security</b></p> <p>For the selected entry (1-5), use this option to enable or disable Security Code protection for the callout. If enabled, the user is required to enter their security in order to log on and hear the new message. If disabled, the Security Code is not required.</p> <p>➤ <i>There are five separately programmed Message notification entries for each Group Mailbox.</i></p>	0 = Security code not required 1 - Security code required	1		✓	

Program Number	Program Name/Description	Input Data	Default	Level		
				1	2	3
47-22-09	<p><b>Group Mailbox Notification Options – Day of Week Sunday</b></p> <p>For the selected entry (1-5), use this option to enable or disable Message Notification on Sunday.</p> <p>➤ <i>There are five separately programmed Message notification entries for each Subscriber Mailbox.</i></p>	<p>0 = Disabled</p> <p>1 = Enabled</p>	1		✓	
47-22-10	<p><b>Group Mailbox Notification Options – Day of Week Monday</b></p> <p>For the selected entry (1-5), use this option to enable or disable Message Notification on Monday.</p> <p>➤ <i>There are five separately programmed Message notification entries for each Subscriber Mailbox.</i></p>	<p>0 = Disabled</p> <p>1 = Enabled</p>	1		✓	
47-22-11	<p><b>Group Mailbox Notification Options – Day of Week Tuesday</b></p> <p>For the selected entry (1-5), use this option to enable or disable Message Notification on Tuesday.</p> <p>➤ <i>There are five separately programmed Message notification entries for each Subscriber Mailbox.</i></p>	<p>0 = Disabled</p> <p>1 = Enabled</p>	1		✓	
47-22-12	<p><b>Group Mailbox Notification Options – Day of Week Wednesday</b></p> <p>For the selected entry (1-5), use this option to enable or disable Message Notification on Wednesday.</p> <p>➤ <i>There are five separately programmed Message notification entries for each Subscriber Mailbox.</i></p>	<p>0 = Disabled</p> <p>1 = Enabled</p>	1		✓	
47-22-13	<p><b>Group Mailbox Notification Options – Day of Week Thursday</b></p> <p>For the selected entry (1-5), use this option to enable or disable Message Notification on Thursday.</p> <p>➤ <i>There are five separately programmed Message notification entries for each Subscriber Mailbox.</i></p>	<p>0 = Disabled</p> <p>1 = Enabled</p>	1		✓	
47-22-14	<p><b>Group Mailbox Notification Options – Day of Week Friday</b></p> <p>For the selected entry (1-5), use this option to enable or disable Message Notification on Friday.</p> <p>➤ <i>There are five separately programmed Message notification entries for each Subscriber Mailbox.</i></p>	<p>0 = Disabled</p> <p>1 = Enabled</p>	1		✓	
47-22-15	<p><b>Group Mailbox Notification Options – Day of Week Saturday</b></p> <p>For the selected entry (1-5), use this option to enable or disable Message Notification on Saturday.</p> <p>➤ <i>There are five separately programmed Message notification entries for each Subscriber Mailbox.</i></p>	<p>0 = Disabled</p> <p>1 = Enabled</p>	1		✓	

## Operation

### To set up Cascade Notification:

1. Access the All Message Notification Setting menu.  
Log onto Subscriber Mailbox.

V	m	a	i	l	-	M	a	i	l	b	o	x	:	1	0	1						
M	s	g	s		N	e	w	:	0			A	r	c	h	:	0					
	L	s	t	n		G	r	e	e	t		L	v	M	s	g		M	o	r	e	>

↓ Dial OP(67) / Press "More >" → "Setup"

Mailbox Options menu.

C	o	n	f	i	g	u	r	e		M	b	o	x		1	0	1						
	C	o	d	e		N	o	t	f	y		C	a	l	l	H			M	o	r	e	>

↓ Dial N(6) / Press "Notify"

Notification Type Selection menu.

M	e	s	s	a	g	e		N	o	t	i	f	i	c	a	t	i	o	n				
	P	h	o	n	e		E	m	a	i	l									B	a	c	k

↓ Dial P(7) / Press "Phone"

All Message Notifications Setting menu.

P	h	o	n	e		N	o	t	i	f	i	c	a	t	i	o	n	:		O	f	f	
		O	n			O	f	f				D	e	s	t				B	a	c	k	

2. All message Notifications Setting menu.

P	h	o	n	e		N	o	t	i	f	i	c	a	t	i	o	n	:		O	f	f	
		O	n			O	f	f				D	e	s	t				B	a	c	k	



↓ Dial O(6) / Press "On"    ↑Dial O(6) / Press "Off"

P	h	o	n	e		N	o	t	i	f	i	c	a	t	i	o	n	:		O	n		
		O	n			O	f	f				D	e	s	t			B	a	c	k		

- Soft key Operation (3-Line Phone/Super Display Phone)
  - On/On Turn                      All Notifications on
  - Off/Off                            Turn All Notifications off
  - Dest/Destinations            Proceed to Notification Destination Selection menu
  - Back/Back                        Go back to Notification Type Selection menu
  
- Key Operation
  - Key 3                              Proceed to Notification Destination Selection menu
  - Key 6                              Toggle All Notifications on/off
  - Key 9                              Exit from mailbox
  - Key #                              Go back to Notification Type Selection menu

3. Notification Destination Selection menu.

P	h	o	n	e		N	o	t	i	f	i	c	a	t	i	o	n	:		O	n		
D	e	s	t	1		D	e	s	t	2		D	e	s	t	3			M	o	r	e	>

↓ Press "More>"    ↑Press "More>"

P	h	o	n	e		N	o	t	i	f	i	c	a	t	i	o	n	:		O	n		
D	e	s	t	4		D	e	s	t	5			B	a	c	k			M	o	r	e	>

- Soft key Operation (3-Line Phone/Super Display Phone)
  - Dest1/Destination1            Proceed to Phone Notification Destination 1 menu
  - Dest2/Destination2            Proceed to Phone Notification Destination 2 menu
  - Dest3/Destination3            Proceed to Phone Notification Destination 3 menu
  - Dest4/Destination4            Proceed to Phone Notification Destination 4 menu
  - Dest5/Destination5            Proceed to Phone Notification Destination 5 menu
  - Back                                Go back to All Message Notifications Setting menu
  
- Key Operation
  - Key 1                              Proceed to Phone Notification Destination 1 menu
  - Key 2                              Proceed to Phone Notification Destination 2 menu
  - Key 3                              Proceed to Phone Notification Destination 3 menu
  - Key 4                              Proceed to Phone Notification Destination 4 menu
  - Key 5                              Proceed to Phone Notification Destination 5 menu
  - Key 9                              Exit from mailbox
  - Key #                              Go back to All Message Notifications Setting menu

4. Message Notification main menu  
InMail plays a summary of your Message Notification settings.

D	e	s	t		1		D	i	s	a	b	l	d		1	2	A	M	-	1	2	A	M
P	h	o	n	e	:																		
	E	n	b	l			D	i	s	b	l		C	h	n	g	e			B	a	c	k

If phone number already exists

D	e	s	t		1		D	i	s	a	b	l	d		0	8	A	M	-	0	6	P	M
P	h	o	n	e	:	2	0	3	9	2	6	5	4	0	0								
	E	n	b	l			D	i	s	b	l		C	h	n	g	e			B	a	c	k

↓ Dial E(3) / Press "Enbl"    ↑Dial D(3) / Press "Disbl"

D	e	s	t		1		E	n	a	b	l	e	d		0	8	A	M	-	0	6	P	M
P	h	o	n	e	:	2	0	3	9	2	6	5	4	0	0								
	E	n	b	l			D	i	s	b	l		C	h	n	g	e			B	a	c	k

- Soft key Operation (3-Line Phone/Super Display Phone)
  - Enbl/Enable    Turn destination[x] notifications on
  - Disbl/Disable    Turn destination[x] notifications off
  - Chnge/Change    Go to destination[x] notification setting menus
  - Back/Back    Go back to Notification Destination Selection menu
- Key Operation
  - Key 2    Go to destination[x] notification setting menus
  - Key 3    Toggle destination[x] notifications on/off.
  - Key #    Go back to Notification Destination Selection menu

5. Message Notification Programming (Begin Hour)

N	o	t	i	f	i	c	a	t	i	o	n		B	e	g	i	n	:		1	2	A	M
													N	e	x	t				E	x	i	t

6. Message Notification Programming (End Hour)

N	o	t	i	f	i	c	a	t	i	o	n		E	n	d	:		1	2	A	M		
													N	e	x	t				E	x	i	t

7. Message Notification Programming (Notification Type)

N	o	t	i	f	y		V	i	a	:		N	u	m	b	e	r						
	N	u	m			P	a	g	e	r			N	e	x	t			E	x	i	t	

8. Message Notification Programming (Number)

N	u	m	b	e	r	:																	
		O	K			C	l	e	a	r			N	e	x	t			E	x	i	t	

9. Message Notification Programming (Security Code Required)

S	e	c	u	r	i	t	y		C	o	d	e		O	p	t	i	o	n				
	R	e	q			N	o	R	e	q			N	e	x	t			E	x	i	t	

- Soft key Operation (3-Line Phone/Super Display Phone)
  - Req/Required Turn "Security Code Required" flag On
  - NoReq/Not Required Turn "Security Code Required" flag Off
  - Next/Next Keep current setting and proceed to Busy Attempt count menu
  - Exit/Exit Keep current setting and return to main Notification menu
- Key Operation
  - Key 7 Turn "Security Code Required" flag On
  - Key 6 Turn "Security Code Required" flag Off
  - Key \* Keep current setting and proceed to Busy Attempt count menu
  - Key # Keep current setting and return to main Notification menu

10. Message Notification Programming (Busy Attempt count)

B	u	s	y		A	t	t	e	m	p	t	s	:		0	5							
														N	e	x	t			E	x	i	t

- Soft key Operation (3-Line Phone/Super Display Phone)
  - Next/Next Keep current setting and proceed to RNA Attempt menu.
  - Exit/Exit Keep current setting and return to main Notification menu
- Key Operation
  - Key 0-9 Set Busy Attempt count
  - Key \* Keep current setting and proceed to RNA Attempt count menu
  - Key # Keep current setting and return to main Notification menu

11. Message Notification Programming (RNA Attempt count)

R	N	A		A	t	t	e	m	p	t	s	:		0	5							
													N	e	x	t			E	x	i	t

- Soft key Operation (3-Line Phone/Super Display Phone)
  - Next/Next      Keep current setting and proceed to main Notification menu
  - Exit/Exit      Keep current setting and return to main Notification menu
  
- Key Operation
  - Key 0-9      Set RNA Attempt count
  - Key \*      Keep current setting and proceed to main Notification menu
  - Key #      Keep current setting and return to main Notification menu

Figure 2-31 Cascade Message Flow Chart 1

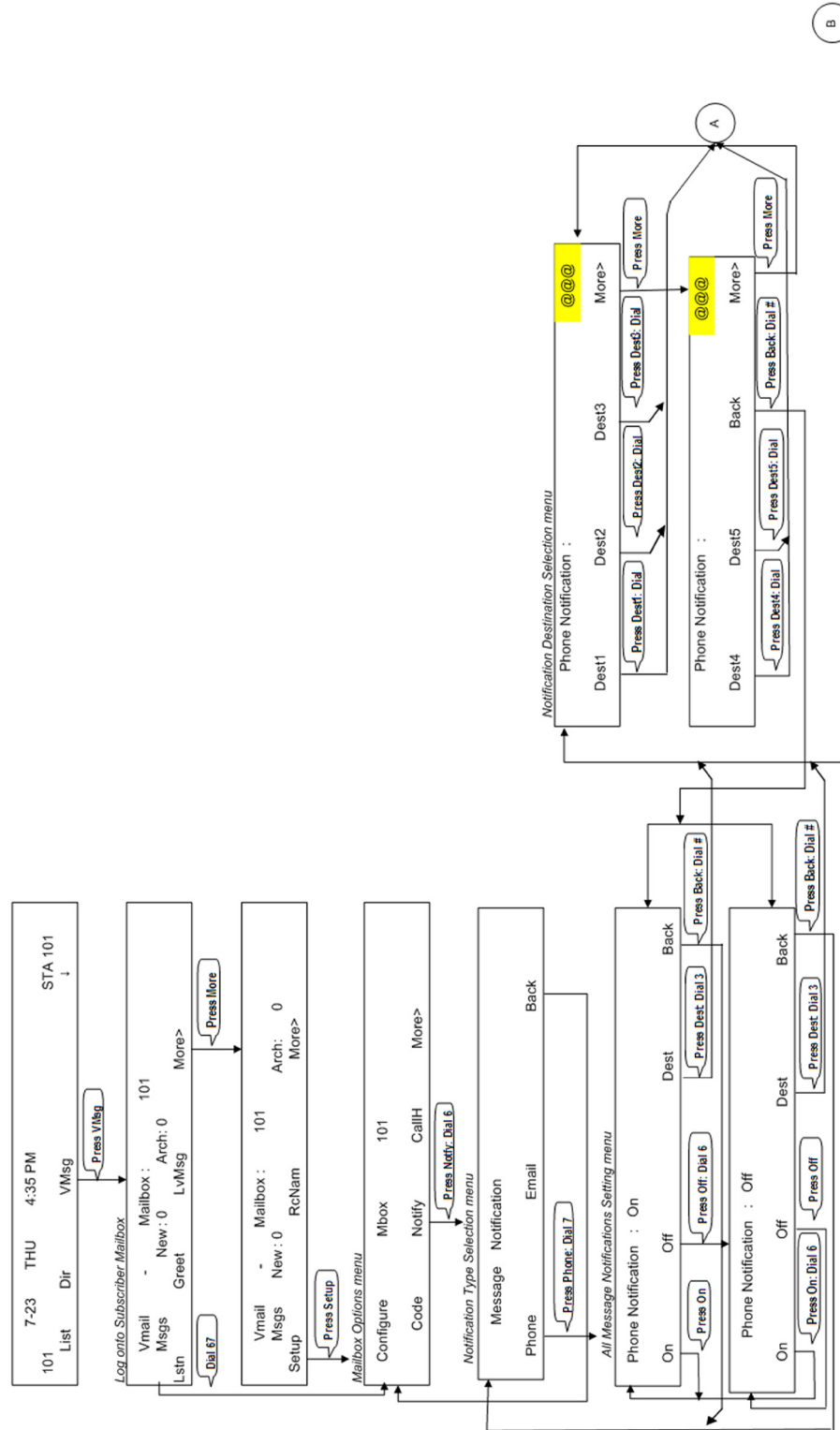
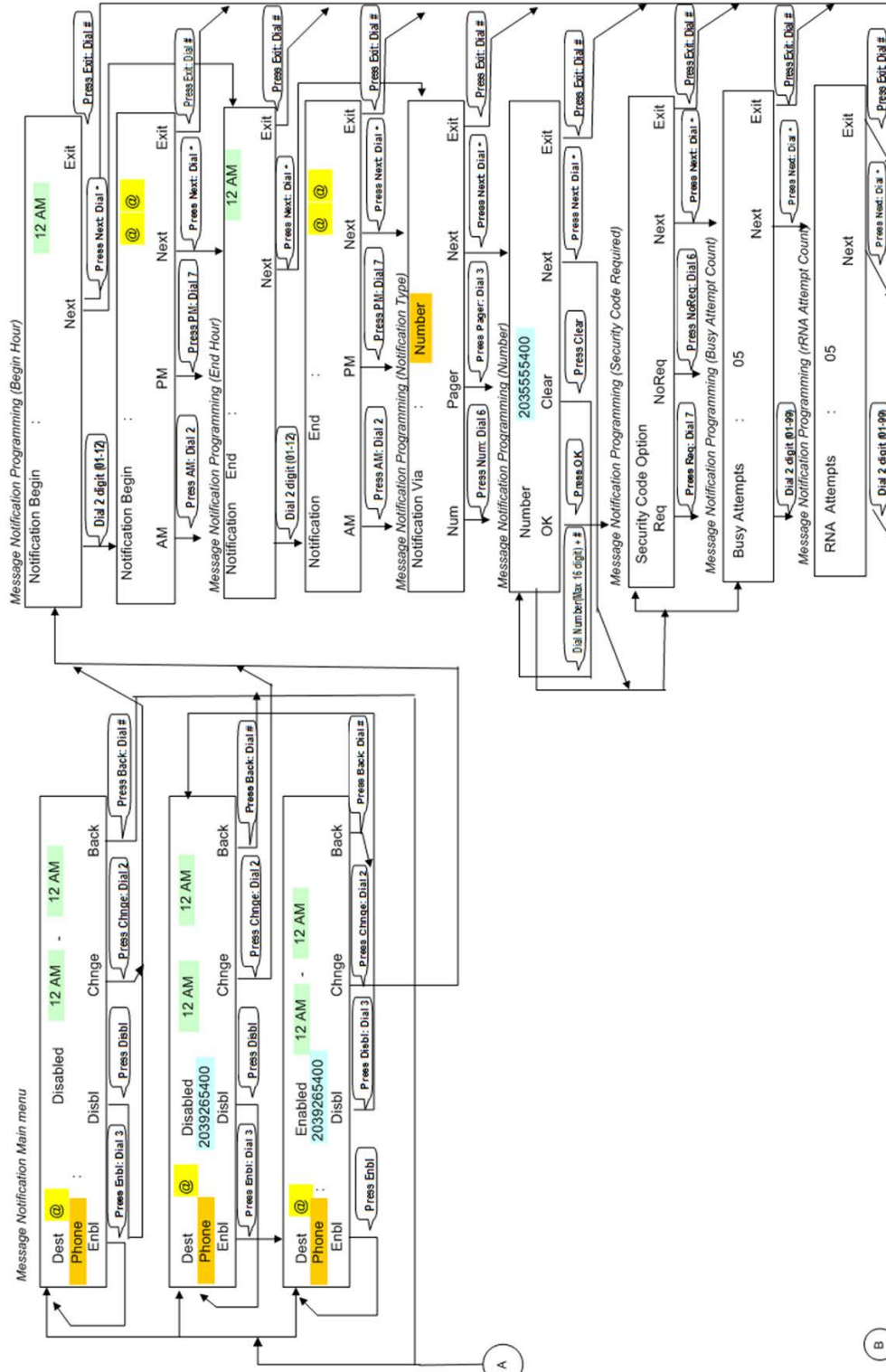

Figure 2-32 Cascade Message Flow Chart 2



## InMail – Email Notification

### Description

Email Notification automatically sends an email notification when a Subscriber Mailbox receives a new message. The email can optionally include the recorded message as a .wav file attachment. To hear the message, the email recipient double-clicks the .wav attachment to have the message play in their wav player (such as Windows Media Player).

Email Notification uses SMTP (Simple Mail Transfer Protocol) to deliver messages to the recipient's email account. If the message recipient has a mobile telephone service provider with an SMS (Short Message Service) portal, they can optionally choose to have text messages delivered right to their cell phone. In either case, Email Notification does not provide synchronization – the email account and the voice mailbox operate independently. For example, deleting the voice mail message does not automatically delete the email and visa-versa.

If Email Notification tries to deliver an email and it doesn't go through because of a connection problem (i.e., no connection or a dropped connection), it will retry every 15 minutes for 24 hours. If the email still can't go through, Email Notification cancels the delivery. Email deliveries that fail because authentication fails or the encryption mode is incorrect are immediately cancelled.

### Collecting the Email Notification Data

In order for the installation site's InMail to send email notifications, it must have a valid SMTP email account assigned. To save time during programming, use the following table to help collect the system's email account information. The email account provider can supply this information. See Programming in this feature for more.

Table 2-39 InMail Email Account Information

Item	Description	System's Email Account Data
SMTP Email Account	The email account that will handle notifications sent from the InMail (e.g., <i>yourname@emailserver.com</i> ).	
SMTP Server Name	The SMTP server (email provider) that will handle email for the SMTP email account. The SMTP server name is typically similar to <i>smtp.emailserver.com</i> .	
SMTP Port Number	The port the SMTP server uses for SMTP delivery.	
SMTP Encryption	Determines whether or not the SMTP server accepts plain text (unencrypted) or encrypted email (Yes or No).	
SMTP Authentication	Enter Yes if the SMTP server requires the <i>SMTP Email Account's</i> user name and password each time the system logs on. Otherwise, enter No.	
SMTP User Name	In the <i>SMTP Email Account</i> , this is normally the <i>your-name</i> portion of <i>yourname@emailserver.com</i> .	

Table 2-39 InMail Email Account Information (Continued)

Item	Description	System's Email Account Data
SMTP Password	This is the password for the account specified in <i>SMTP Email Account</i> above.	
Email Reply To	If a notification recipient replies to a notification email, this is the address to which the reply is sent.	

### Explanation of the Message Sender (From) Field

Like any other email client, Email Notification uses the *From* field to identify the person that left the message being delivered. In the email message, the data in the *From* field is formatted as *Name [Reply To]*, where:

- Name* identifies the person that left the message.
- Reply To*<sup>2</sup> is the email address used when the email recipient replies to the message.
  - ◇ *This information is not provided in the recipient's inbox – just the actual email message.*

For messages left by **Intercom** callers:

- Name* is:
  - The extension name (if programmed).
  - **OR** -
  - The extension number (if there is no name programmed).
- Reply To*<sup>4</sup> is:
  - The email address of the person that left the message (if programmed).
  - **OR** -
  - The *Reply To Email Address* data from Program 47-18-09.
  - **OR** -
  - The *Send From Email Address* data from Program 47-18-09.

For messages left by **Outside** callers:

- Name* is always the text "Outside Caller".
- Reply To*<sup>3</sup> is:
  - The *Reply To Email Address* data from Program 47-18-09.
  - **OR** -
  - The *Send From Email Address* data from Program 47-18-09.

2. The recipient's inbox only shows the Name portion of the From field. The Reply To portion is not included.  
 3. The recipient's inbox only shows the Name portion of the From field. The Reply To portion is not included.



### SMS Text Message Delivery to a Cell Phone

The table below shows the basic format of a InMail email notification delivered to a cell phone as an SMS Text Message. The information is much the same as that delivered to an email account. There may be more than one text message for each notification, depending on the number of characters the provider allows in each text message (typically 120-160 characters). SMS will not send the wav file attachment, even if enabled in programming.



*An extension set up for notification via SMS Text Messaging should have the Email Message as Attachment option disabled in system programming. Attempting to deliver a wav file attachment to an SMS messaging service may have undesirable results.*

SMS Text Message Notification

The following shows a typical SMS Text Message when the InMail is set up to provide email notification only (no wav file of the actual message). In this case, the provider divided the message into two parts: one for the message header and one for the message body. This is only an example – your provider may handle similar content differently.

Table 2-40 Typical SMS Notification (No Wav File)

Description	Text
<b>Text Message for Message Header</b>	
Text Message Inbox:	InMail [2 OF 2]
Text Message Body: <sup>1</sup>	MESSAGE FROM: InMail [2 OF 2] SENT: 3:51PM 9/17
<b>Text Message for Message Body</b>	
Text Message Inbox:	SBJ:VOICE MESSAGE
Text Message Body: <sup>1</sup>	MESSAGE FROM: XXXX SUBJ: VOICE MESSAGE FROM XXXX- (0M6S) VOICE MESSAGE ARRIVED ON MONDAY, SEPT 17@3:51 PMDURATION: 0M 6S -----NEC [1 OF 2] SENT: 3:51PM 09/17

1 Your cell phone display will automatically break the text lines to best fit the screen.

### POP3 Login

InMail Email Notification supports POP3 Login. The logic of this method is that it allows a user to send e-mail from any location, as long as they can demonstrably also fetch their mail from the same place. Check with your email provider to see if this type of login is required.

## Some Common SMTP Settings

Table 2-41 Common Email Notification SMTP Server Settings

Provider	Server Name and Account (1105-02, 08)	SMTP Port (1105-03)	Encryption (1105-04)	Authentication (1105-05, 06, 07)	Updated	Comments
Yahoo	smtp.mail.yahoo.com	465	Yes	Yes	6/28/07	Requires POP Yahoo! Mail Plus
GMail	smtp.gmail.com	465	Yes	Yes	6/28/09	
Optimum Online	mail.optonline.net	587	Yes	Yes	6/28/07	
AOL	smtp.aol.com	587	Yes	Yes	6/28/07	

## Some Common SMS Portals

Table 2-42 Some Common Mobile Telephone Service Provider SMS Portals

Provider	Email Address for SMS Text Message
<b>Some Popular Provider-Specific SMS Portals</b>	
Alltel	yourcellphonenumber@message.alltel.com
AT&T Wireless	yourcellphonenumber@mobile.att.net OR yourcellphonenumber@mmode.net
Boost Mobile	yourcellphonenumber@myboostmobile.com
Cingular	yourcellphonenumber@mobile.mycingular.com OR yourcellphonenumber@cingularme.com
Nextel	yourcellphonenumber@messaging.nextel.com OR yourcellphonenumber@page.nextel.com
Sprint PCS	yourcellphonenumber@messaging.sprintpcs.com
T-Mobile	yourcellphonenumber@tmail.com OR yourcellphonenumber@tmomail.net
Verizon	yourcellphonenumber@vtext.com
Virgin Mobile	yourcellphonenumber@vmobl.com
<b>A Universal SMS Portal</b>	
Teleflip	yourcellphonenumber@teleflip.com
<b>A More Complete SMS Portal Listing</b>	
For a more complete SMS portal list, see <a href="http://www.livejournal.com/tools/textmessage.bml?mode=details">http://www.livejournal.com/tools/textmessage.bml?mode=details</a> .	

### Conditions

- SV9100 software required to support this feature.
- The Email Notification feature (1014) is licensed on a per mailbox basis.
- The Email Notification feature (1014) license is not required for Group Mailboxes.
- Refer to the InMail System Guide for more information about this feature.
- A mailbox set for E-mail Notification can use the following settings for the forwarded message:
  - Save: A forwarded voice message is archived and kept in the mailbox.
  - Delete: A forwarded voice message is deleted from the Mail Box.
  - No Change: A forwarded voice message is kept as "New" in the mailbox.
- Email Notification options can only be changed from WebPro, PCPro or system programming for *group subscriber* mailboxes.
- Email Notification options can only be changed from UserPro, WebPro, PCPro or system programming for *station subscriber* mailboxes.

### Default Settings

Disabled

## System Availability

### Terminals

All Multiline Terminals

### Required Component(s)

- 1014 – SV9100 InMail Email Client Lic
- 1012 – SV9100 InMail VM Box Lic
- 0411 – SV9100 Version Lic (R1)

### Related Features

None

## Guide to Feature Programming

The **Level 1**, **Level 2** and **Level 3** columns indicate the programs that are assigned when programming this feature in the order they are most commonly used. These levels are used with PCPro and WebPro wizards for feature programming.

- Level 1 – these are the most commonly assigned programs for this feature.
- Level 2 – these are the next most commonly assigned programs for this feature.
- Level 3 – these programs are not often assigned and require an expert level working knowledge of the system to be properly assigned.

Program Number	Program Name/Description	Input Data	Default	Level		
				1	2	3
47-02-20	<b>SV9100 InMail Station Mailbox Options – Enable E-mail Notification</b> Enables the email notification feature on a per mailbox basis.	0 = Off 1 = On	0	✓		
47-02-21	<b>SV9100 InMail Station Mailbox Options – E-mail Address</b> Assigns the destination email address on a per mailbox basis.	Maximum of 48 characters.	No Setting	✓		
47-02-22	<b>SV9100 InMail Station Mailbox Options – Include Message as Attachment</b> Determines if the email notification includes the voice message as a WAV file attachment. This should be set to 0 if sending an SMS text message to a cell phone.	0 = Off 1 = On	0	✓		
47-02-27	<b>SV9100 InMail Station Mailbox Options – Email Message Save/Delete Option</b> When email notification is enabled, use this option to set how notification handles new voice mail message content. If <b>No Change</b> is selected, the message remains New in their mailbox after a successful SMTP delivery. If <b>Save</b> is selected, the message is marked as “Saved” in their mailbox after a successful SMTP delivery. If <b>Delete</b> is selected, the message will be deleted from their mailbox after a successful SMTP delivery.	0 = No Change 1 = Save 2 = Delete	0		✓	
47-06-18	<b>Group Mailbox Subscriber Options – Enable E-mail Notification</b> Enables email notification feature on a per mailbox basis.	0 = Off 1 = On	0		✓	
47-06-19	<b>Group Mailbox Subscriber Options – E-mail Address</b> Assigns the destination email address on a per mailbox basis.	Maximum of 48 characters.	No Setting		✓	

Program Number	Program Name/Description	Input Data	Default	Level		
				1	2	3
47-06-20	<p><b>Group Mailbox Subscriber Options – Include Message as Attachment</b></p> <p>Determines if the email notification includes the voice message as a WAV file attachment. This should be set to 0 if sending an SMS text message to a cell phone.</p>	<p>0 = Off 1 = On</p>	1		✓	
47-06-25	<p><b>Group Mailbox Subscriber Options – Email Message Save/Delete Option</b></p> <p>When email notification is enabled, use this option to set how notification handles new voice mail message content.</p> <p>If <b>No Change</b> is selected, the message remains New in their mailbox after a successful SMTP delivery.</p> <p>If <b>Save</b> is selected, the message is marked as “Saved” in their mailbox after a successful SMTP delivery.</p> <p>If <b>Delete</b> is selected, the message will be deleted from their mailbox after a successful SMTP delivery.</p>	<p>0 = No Change 1 = Save 2 = Delete</p>	0		✓	
47-18-01	<p><b>InMail SMTP Setup – SMTP Enabled</b></p> <p>Enables the SMTP forwarding feature for the system.</p>	<p>0 = No 1 = Yes</p>	0	✓		
47-18-02	<p><b>InMail SMTP Setup – Server Name</b></p> <p>Sets the SMTP server name. If the DNS server setting is not assigned in Program 90-11-11, the IP Address must be used instead of the name.</p>	Maximum of 48 characters.	No Setting	✓		
47-18-03	<p><b>InMail SMTP Setup – SMTP Port</b></p> <p>Sets the SMTP server port.</p>	0 ~ 65535	25		✓	
47-18-04	<p><b>InMail SMTP Setup – Encryption</b></p> <p>Enable SSL Encryption.</p>	<p>0 = No 1 = Yes</p>	0		✓	
47-18-05	<p><b>InMail SMTP Setup – Authentication</b></p> <p>Enables authentication, when set to 2 (POP3) refer to Programs 47-19-xx.</p>	<p>0 = No 1 = Yes 3 = POP3</p>	0		✓	
47-18-06	<p><b>InMail SMTP Setup – User Name</b></p> <p>Set the user name for SMTP authentication.</p>	Maximum of 48 characters.	No Setting		✓	
47-18-07	<p><b>InMail SMTP Setup – Password</b></p> <p>Set the password for SMTP authentication.</p>	Maximum of 48 characters.	No Setting		✓	
47-18-08	<p><b>InMail SMTP Setup – E-mail Address</b></p> <p>Set the email address for the system. This is the “from address” for outgoing emails.</p>	Maximum of 48 characters.	No Setting	✓		
47-18-09	<p><b>InMail SMTP Setup – Reply to Address</b></p> <p>Set the email address for replies to outgoing emails. This email account is not monitored by the system and must be checked manually.</p>	Maximum of 48 characters.	No Setting	✓		

Program Number	Program Name/Description	Input Data	Default	Level		
				1	2	3
47-19-01	<b>InMail POP3 Setup – Server Name</b> Set the POP3 server name. If the DNS server setting is not assigned in Program 90-11-11 the IP Address must be used instead of the name.	Maximum of 48 characters.	No Setting		✓	
47-19-02	<b>InMail POP3 Setup – POP3 Port</b> Set the POP3 server port.	0 ~ 65535	110		✓	
47-19-03	<b>InMail POP3 Setup – SSL Encryption</b> Enable SSL encryption.	0 = No 1 = Yes	0		✓	
47-19-04	<b>InMail POP3 Setup – User Name</b> Set the user name for POP3 authentication.	Maximum of 48 characters.	No Setting		✓	
47-19-05	<b>InMail POP3 Setup – Password</b> Set the password for POP3 authentication.	Maximum of 48 characters.	No Setting		✓	
90-11-11	<b>System Alarm Report – DNS Primary Address</b> Assign the primary DNS IP Address. If this setting is not assigned, the IP Address must be used in Program 47-18-02 and 47-19-01 instead of the name.	0.0.0.0 ~ 255.255.255.255	0.0.0.0	✓		
90-11-12	<b>System Alarm Report – DNS Secondary Address</b> Assign the secondary DNS server IP Address.	0.0.0.0 ~ 255.255.255.255	0.0.0.0	✓		

Operation



REFERENCE

Refer to the InMail System Guide for more information about this feature.

Table 2-43 Turn Email Notification On or Off

To Turn Email Notification On or Off		
1.	Log onto Subscriber Mailbox	
2.	<b>[Setup]</b>	Select Mailbox Options. ○ Alternately dial <b>OP</b> (67)
3.	<b>[Notfy]</b>	Select Notification. ○ Alternately dial <b>N</b> (6)
4.	<b>[Email]</b>	Select Email. ○ Alternately dial <b>E</b> (3)
5.	Do one of the following:	
	a.	<b>[On]</b> Select to turn email notification on. ○ Alternately dial <b>O</b> (6)
	b.	<b>[Off]</b> Select to turn email notification off. ○ Alternately dial <b>O</b> (6)
	c.	<b>[Back]</b> Select to exit without making any changes. ○ Alternately dial <b>#</b>

## *InMail – Find-Me Follow-Me*

### Description

Find-Me Follow-Me helps an outside caller locate an extension user who is not at their desk. If their call is unanswered and is picked up by voice mail, the caller has the option of dialing a digit to try up to three alternate Find-Me Follow-Me destinations. A destination can be an outside number (such as a cell phone or home office) or a co-worker's extension.

The Find-Me Follow-Me destinations are set up in the Notification Schedule. Each of the three entries can be individually enabled or disabled and provides options for:

- Start Hour: Time the destinations become active.
- End Hour: Time the destinations become inactive.
- Number: The destination telephone, pager or extension number.
- Days of Week: Days of the week the destinations are active or inactive.

If the caller chooses the Find-Me Follow-Me option, the system will try each enabled entry that is active for the current date and time (i.e., in-schedule). The system will not try any entries that are disabled or are not in-schedule.

When trying the destinations, Find-Me Follow-Me skips an active, in-schedule number that is busy, in DND, or is unanswered. If a destination is answered the party must dial 1 and if enabled enter the security code to hear new messages. If the system is forwarded to a voice mail system since the destination does not enter a 1 it will be counted as a failed attempt and the system will move on to the next destination. When all active in-schedule destinations have been tried the caller can then choose to try Find-Me Follow-Me again or select another option.

You can set up Find-Me Follow-Me for an extension in system programming. In addition, an extension user can set up Find-Me Follow-Me from their Mailbox Options.

### Conditions

- Find-Me Follow-Me settings can be changed using the Telephone Mailbox Option Interface and system programming only.
- Find-Me Follow-Me can be used for standard subscriber mailboxes and Group Mailboxes set to subscriber in Program 47-03-03.
- Find-Me Follow-Me does not work for internal callers.
- Find-Me Follow-Me does not work for calls forwarded to InMail, this includes DID/DIL calls.
- Find-Me Follow-Me requires that Tandem Trunking be enabled on the line that rings into the Automated Attendant. If Tandem Trunking is not enabled, the Find-Me Follow-Me options are not available.



## Default Settings

Enabled

## System Availability

### Terminals

All Multiline Terminals

### Required Component(s)

- 1012 – SV9100 InMail VM Box Lic
- 0411 – SV9100 Version Lic (R1)

## Related Features

None

## Guide to Feature Programming

The **Level 1**, **Level 2** and **Level 3** columns indicate the programs that are assigned when programming this feature in the order they are most commonly used. These levels are used with PCPro and WebPro wizards for feature programming.

- Level 1 – these are the most commonly assigned programs for this feature.
- Level 2 – these are the next most commonly assigned programs for this feature.
- Level 3 – these programs are not often assigned and require an expert level working knowledge of the system to be properly assigned.

Program Number	Program Name/Description	Input Data	Default	Level		
				1	2	3
14-01-13	<b>Basic Trunk Data Setup – Trunk-to-Trunk Transfer</b> Enable/Disable loop supervision for the trunk.	0 = Disabled 1 = Enabled	1		✓	
20-11-14	<b>Class of Service Options (Hold/Transfer Service) – Trunk-to-Trunk Transfer Restriction</b> Make sure this option is disabled or Find-Me Follow-Me will not work for CO calls.	0 = Disabled 1 = Enabled	0			✓

Program Number	Program Name/Description	Input Data	Default	Level		
				1	2	3
47-02-24	<p><b>SV9100 InMail Station Mailbox Options – All Find-Me Follow-Me Enabled</b></p> <p>Use this option to enable or disable Find-Me Follow-Me for the extension. If disabled, enabling the individual notification entries has no effect.</p>	<p>0 = Disabled 1 = Enabled</p>	0	✓		
47-06-22	<p><b>Group Mailbox Subscriber Options – All Find-Me Follow-Me Enabled</b></p> <p>Use this option to enable or disable Find-Me Follow-Me for the group mailbox. If disabled, enabling the individual notification entries has no effect.</p>	<p>0 = Disabled 1 = Enabled</p>	0		✓	
47-21-01	<p><b>Station Mailbox Find-Me Follow-Me Options – Find-Me Follow-Me</b></p> <p>Use this option to enable or disable a Find-Me Follow-Me destination. If enabled, Find-Me Follow-Me will occur according to the settings for Start Hour, End Hour, days of week and Find-Me Follow-Me Phone Number. If disabled, Find-Me Follow-Me will not occur.</p>	<p>0 = Disabled 1 = Enabled</p>	0	✓		
47-21-02	<p><b>Station Mailbox Find-Me Follow-Me Options – Find-Me Follow-Me Begin Hour</b></p> <p>Use this option to set the hour when Find-Me Follow-Me will start. Find-Me Follow-Me will occur only between this setting and the End Hour setting.</p>	0 ~ 23 (24 Hour Clock)	No Setting	✓		
47-21-03	<p><b>Station Mailbox Find-Me Follow-Me Options – Find-Me Follow-Me End Hour</b></p> <p>Use this option to set the hour when Find-Me Follow-Me will end. Find-Me Follow-Me will occur only between this the Start Hour and this setting.</p>	0 ~ 23 (24 Hour Clock)	No Setting	✓		
47-21-04	<p><b>Station Mailbox Find-Me Follow-Me Options – Find-Me Follow-Me Number</b></p> <p>Use this option to set the telephone number Find-Me Follow-Me will dial. Enter the number exactly as you want the system to dial it (including a leading 1 for toll calls, if required), but do not include a line access code (such as 9). If the number you enter is extension number, it will be an Intercom call. Otherwise, it will be an outside call. (The system decides by referring its numbering plan.)</p>	Maximum of 16 digits.	No Setting	✓		
47-21-05	<p><b>Station Mailbox Find-Me Follow-Me Options – Day of Week Sunday</b></p> <p>For the selected entry (1-3), use this option to enable or disable Find-Me Follow-Me on Sunday.</p> <p>➡ <i>There are three separately programmed Find-Me Follow-Me entries for each Subscriber Mailbox.</i></p>	<p>0 = Disabled 1 = Enabled</p>	1		✓	

Program Number	Program Name/Description	Input Data	Default	Level		
				1	2	3
47-21-06	<p><b>Station Mailbox Find-Me Follow-Me Options – Day of Week Monday</b></p> <p>For the selected entry (1-3), use this option to enable or disable Find-Me Follow-Me on Monday.</p> <p>➤ <i>There are three separately programmed Find-Me Follow-Me entries for each Subscriber Mailbox.</i></p>	<p>0 = Disabled</p> <p>1 = Enabled</p>	1		✓	
47-21-07	<p><b>Station Mailbox Find-Me Follow-Me Options – Day of Week Tuesday</b></p> <p>For the selected entry (1-3), use this option to enable or disable Find-Me Follow-Me on Tuesday.</p> <p>➤ <i>There are three separately programmed Find-Me Follow-Me entries for each Subscriber Mailbox.</i></p>	<p>0 = Disabled</p> <p>1 = Enabled</p>	1		✓	
47-21-08	<p><b>Station Mailbox Find-Me Follow-Me Options – Day of Week Wednesday</b></p> <p>For the selected entry (1-3), use this option to enable or disable Find-Me Follow-Me on Wednesday.</p> <p>➤ <i>There are three separately programmed Find-Me Follow-Me entries for each Subscriber Mailbox.</i></p>	<p>0 = Disabled</p> <p>1 = Enabled</p>	1		✓	
47-21-09	<p><b>Station Mailbox Find-Me Follow-Me Options – Day of Week Thursday</b></p> <p>For the selected entry (1-3), use this option to enable or disable Find-Me Follow-Me on Thursday.</p> <p>➤ <i>There are three separately programmed Find-Me Follow-Me entries for each Subscriber Mailbox.</i></p>	<p>0 = Disabled</p> <p>1 = Enabled</p>	1		✓	
47-21-10	<p><b>Station Mailbox Find-Me Follow-Me Options – Day of Week Friday</b></p> <p>For the selected entry (1-3), use this option to enable or disable Find-Me Follow-Me on Friday.</p> <p>➤ <i>There are three separately programmed Find-Me Follow-Me entries for each Subscriber Mailbox.</i></p>	<p>0 = Disabled</p> <p>1 = Enabled</p>	1		✓	
47-21-11	<p><b>Station Mailbox Find-Me Follow-Me Options – Day of Week Saturday</b></p> <p>For the selected entry (1-3), use this option to enable or disable Find-Me Follow-Me on Saturday.</p> <p>➤ <i>There are three separately programmed Find-Me Follow-Me entries for each Subscriber Mailbox.</i></p>	<p>0 = Disabled</p> <p>1 = Enabled</p>	1		✓	

Program Number	Program Name/Description	Input Data	Default	Level		
				1	2	3
47-23-01	<p><b>Group Mailbox Find-Me Follow-Me Options – Find-Me Follow-Me</b></p> <p>Use this option to enable or disable a Find-Me Follow-Me destination. If enabled, Find-Me Follow-Me will occur according to the settings for Start Hour, End Hour, days of week and Find-Me Follow-Me Phone Number. If disabled, Find-Me Follow-Me will not occur.</p>	<p>0 = Disabled 1 = Enabled</p>	0		✓	
47-23-02	<p><b>Group Mailbox Find-Me Follow-Me Options – Find-Me Follow-Me Begin Hour</b></p> <p>Use this option to set the hour when Find-Me Follow-Me will start. Find-Me Follow-Me will occur only between this setting and the End Hour setting.</p>	0 ~ 23 (24 Hour Clock)	No Setting		✓	
47-23-03	<p><b>Group Mailbox Find-Me Follow-Me Options – Find-Me Follow-Me End Hour</b></p> <p>Use this option to set the hour when Find-Me Follow-Me will end. Find-Me Follow-Me will occur only between this the Start Hour and this setting.</p>	0 ~ 23 (24 Hour Clock)	No Setting		✓	
47-23-04	<p><b>Group Mailbox Find-Me Follow-Me Options – Find-Me Follow-Me Number</b></p> <p>Use this option to set the telephone number Find-Me Follow-Me will dial. Enter the number exactly as you want the system to dial it (including a leading 1 for toll calls, if required), but do not include a line access code (such as 9). If the number you enter is extension number, it will be an Intercom call. Otherwise, it will be an outside call. (The system decides by referring its numbering plan.)</p>	Maximum of 16 digits.	No Setting		✓	
47-23-05	<p><b>Group Mailbox Find-Me Follow-Me Options – Day of Week Sunday</b></p> <p>For the selected entry (1-3), use this option to enable or disable Find-Me Follow-Me on Sunday.</p> <p>➤ <i>There are three separately programmed Find-Me Follow-Me entries for each Subscriber Mailbox.</i></p>	<p>0 = Disabled 1 = Enabled</p>	1		✓	
47-23-06	<p><b>Group Mailbox Find-Me Follow-Me Options – Day of Week Monday</b></p> <p>For the selected entry (1-3), use this option to enable or disable Find-Me Follow-Me on Monday.</p> <p>➤ <i>There are three separately programmed Find-Me Follow-Me entries for each Subscriber Mailbox.</i></p>	<p>0 = Disabled 1 = Enabled</p>	1		✓	

Program Number	Program Name/Description	Input Data	Default	Level		
				1	2	3
47-23-07	<p><b>Group Mailbox Find-Me Follow-Me Options – Day of Week Tuesday</b></p> <p>For the selected entry (1-3), use this option to enable or disable Find-Me Follow-Me on Tuesday.</p> <p>➤ <i>There are three separately programmed Find-Me Follow-Me entries for each Subscriber Mailbox.</i></p>	<p>0 = Disabled 1 = Enabled</p>	1		✓	
47-23-08	<p><b>Group Mailbox Find-Me Follow-Me Options – Day of Week Wednesday</b></p> <p>For the selected entry (1-3), use this option to enable or disable Find-Me Follow-Me on Wednesday.</p> <p>➤ <i>There are three separately programmed Find-Me Follow-Me entries for each Subscriber Mailbox.</i></p>	<p>0 = Disabled 1 = Enabled</p>	1		✓	
47-23-09	<p><b>Group Mailbox Find-Me Follow-Me Options – Day of Week Thursday</b></p> <p>For the selected entry (1-3), use this option to enable or disable Find-Me Follow-Me on Thursday.</p> <p>➤ <i>There are three separately programmed Find-Me Follow-Me entries for each Subscriber Mailbox.</i></p>	<p>0 = Disabled 1 = Enabled</p>	1		✓	
47-23-10	<p><b>Group Mailbox Find-Me Follow-Me Options – Day of Week Friday</b></p> <p>For the selected entry (1-3), use this option to enable or disable Find-Me Follow-Me on Friday.</p> <p>➤ <i>There are three separately programmed Find-Me Follow-Me entries for each Subscriber Mailbox.</i></p>	<p>0 = Disabled 1 = Enabled</p>	1		✓	
47-23-11	<p><b>Group Mailbox Find-Me Follow-Me Options – Day of Week Saturday</b></p> <p>For the selected entry (1-3), use this option to enable or disable Find-Me Follow-Me on Saturday.</p> <p>➤ <i>There are three separately programmed Find-Me Follow-Me entries for each Subscriber Mailbox.</i></p>	<p>0 = Disabled 1 = Enabled</p>	1		✓	

## Operation

Setting Up Message Notification					
<b>Log On to Subscriber Mailbox.</b>					
OP (67)	Access the Mailbox Options menu. [Setup]				
	N (6)	Access the Message Notification Options Menu. [Notfy]			
		InMail plays a summary of your Message Notification settings. The your telephone display shows your current notification settings (see sample below). For telephone numbers Notify On 8am- 5pm Number: 12039265400 <b>- OR -</b> For Pager Numbers Notify On 8am- 5pm Pager: 12039265400			
		O (6)	Turn Message Notification on or off. [On] [Off]		
		C (2)	Change your Message Notification setup. [Chnge]		
			When you see: Notification Begin		
			Enter the hour you want Message Notification to begin. Enter 2 digits for the hour		
				A (2)	Select AM [AM]
				P (7)	Select PM [PM]
			*	Skip this option without changing your entry. [Next]	
			#	Back up to the previous level without changing your entry. [Exit]	
			<b>When you see: Notification End</b>		
			<b>Enter the hour you want Message Notification to end.</b> o Enter 2 digits for the hour. o For 24-hour notification, make the End Time the same as the Start Time.		
				A (2)	Select AM [AM]
				P (7)	Select PM [PM]

Setting Up Message Notification (Continued)				
			*	Skip this option without changing your entry. [Next]
			#	Back up to the previous level without changing your entry. [Exit]
<b>When you see: Notify Via</b>				
			<b>N (6)</b>	The notification destination is a telephone number. [Num]
			<b>D (3)</b>	The notification destination is a digital pager. [Pager]
			*	Skip this option without changing your entry. [Next]
			#	Back up to the previous level without changing your entry. [Exit]
<b>When you see: Number</b>				
				Enter the Message Notification callout number (16 digits max). <ul style="list-style-type: none"> <li>o Enter the number exactly as you want the system to dial it (including a leading 1 for toll calls, if required).</li> <li>o If the number you enter is 4 digits or less, it is an Intercom call. If it is more than 4 digits, it is an outside call.</li> </ul>
			#	Accept the number entered and back up to the previous level. [OK]
			<b>[Clear]</b>	Erase the number you just entered.
			*	Skip this option without changing your entry. [Next]
			#	Back up to the previous level without changing your entry. [Exit]
		#		Go back to the Mailbox Options menu. [Exit]
	#			Go back to the Main Menu. [Exit]
<b>0</b>	Plays Help message.			

## InMail – Language Setting

### Description

The Language setting feature allows the telephone display language and the InMail mailbox language to be changed from the telephone. This can be used to change either the user's phone or another specified telephones display and InMail language if allowed in system programming. Either a dial access code or Softkey operation is available.

### Conditions

- The telephone display language can be changed using dial access codes or softkeys only.
- The InMail language can be changed using dial access codes or softkeys only.
- The ability to change other extensions language options is allowed on a class of service basis in Program 20-13-53.
- The system will not allow an InMail language to be selected if that language prompt set has not been loaded onto the InMail SD card. When an invalid language is selected an error tone is heard.

### Supported Languages

- 01 (US English)
- 02 (UK English)
- 03 (Australian English)
- 04 (French Canadian)
- 05 (Dutch)
- 06 (Mexican Spanish)
- 07 (Latin America Spanish)
- 08 (Italian)
- 09 (German)
- 10 (Madrid Spanish)
- 11 (Norwegian)
- 12 (Parisian French)
- 13 (Brazilian Portuguese)
- 14 (Japanese)
- 15 (Mandarin Chinese)



- 16 (Korean)
- 17 (Iberian Portuguese)
- 18 (Greek)
- 19 (Danish)
- 20 (Swedish)
- 21 (Thai)
- 22 (Taiwan)
- 23 (Flemish)
- 24 (Turkish)
- 25 (Reserved)
- 26 (Russian)

### Default Settings

Enabled

## System Availability

### Terminals

All Multiline Terminals

### Required Component(s)

- 1012 – SV9100 InMail VM Box Lic
- 0411 – SV9100 Version Lic (R1)

## Related Features

None

## Guide to Feature Programming

The **Level 1**, **Level 2** and **Level 3** columns indicate the programs that are assigned when programming this feature in the order they are most commonly used. These levels are used with PCPro and WebPro wizards for feature programming.

- Level 1 – these are the most commonly assigned programs for this feature.
- Level 2 – these are the next most commonly assigned programs for this feature.
- Level 3 – these programs are not often assigned and require an expert level working knowledge of the system to be properly assigned.

Program Number	Program Name/Description	Input Data	Default	Level		
				1	2	3
11-11-13	<b>Service Code Setup (for Setup/Entry Operation) – Display Language Selection for Multiline Terminal</b> If needed, redefine the service code used to select the language for display multiline terminals.	MLT 0 ~ 9, *, # Maximum of eight digits	678		✓	
11-11-68	<b>Service Code Setup (for Setup/Entry Operation) – IntraMail Language Selection for own Extension</b> This setting is needed if the dial access code to this feature is desired.	MLT 0 ~ 9, *, # Maximum of eight digits	No Setting		✓	
11-11-69	<b>Service Code Setup (for Setup/Entry Operation) – IntraMail Language Selection for Specific Extension</b> This setting is needed if the dial access code to this feature is desired.	MLT 0 ~ 9, *, # Maximum of eight digits	No Setting		✓	
20-13-53	<b>Class of Service Options (Supplementary Service) – Language Selection for Specific Extension</b> This setting must be Enabled (1) for a telephones Class of Service for this feature to function.	0 = Disabled 1 = Enabled	0	✓		

Program Number	Program Name/Description	Input Data	Default	Level		
				1	2	3
40-07-01	<b>Voice Prompt Language Assignment for VRS</b> Specify the language to be used for the InMail prompts.	1 = US English 2 = UK English 3 = AU English 4 = CA French 5 = Dutch 6 = Mex Spanish 7 = LA Spanish 8 = Italian 9 = German 10 = ES Spanish 11 = Norwegian 12 = ParisFrench 13 = BR Portugue 14 = Japanese 15 = MandChinese 16 = Korean 17 = IB Portugue 18 = Greek 19 = Danish 20 = Swedish 21 = Thai 22 = Taiwan 23 = Flemish 24 = Turkish 25 = Reserved 26 = Russian	1		✓	

## Operation

Table 2-44 Language Setting Operation

From an Idle Display Phone	
↓	Press down arrow
Prog	Press Program Softkey
↓	Press down arrow
↓	Press down arrow
Lang	Press Language Softkey
Disp	To change telephone display language press Display Softkey.
Own	To change your own extension display language press Own Softkey.
Choose Lang	Select desired language, press down arrow to advance to next page. Press softkey for desired language.
Press Speaker Exit	
Other	To change another extension display language press Other softkey.
Ext #	Enter the extension number to be changed.
Choose Lang	Select desired language, press down arrow to advance to next page. Press softkey for desired language.
Press Speaker Exit	
VMail	To change spoken InMail mailbox language press VMail Softkey.
Own	To change your own extension display language press Own Softkey.
Choose Lang	Select desired language, press down arrow to advance to next page. Press softkey for desired language.
Press Speaker Exit	
Other	To change another spoken mailbox language press Other softkey.
Ext #	Enter the extension number to be changed.
Choose Lang	Select desired language, press down arrow to advance to next page. Press softkey for desired language.
Press Speaker Exit	

## *InMail – Park and Page*

### Description

InMail – Park and Page can automatically Park a call at an extension and Page the user with a recorded Paging Message announcing the parked call. The called extension user can then go to any telephone and implement Personal Park to pick up the call. With InMail – Park and Page, InMail tries to locate the person instead of just sending the call to their mailbox. Additionally, there is no need for an operator or receptionist to manually answer the call, park it, and then try to track down the employee.

The Paging Message is usually recorded in the user's own voice and typically says something like, "Mike Smart, you have a call." If the Paging Message is not recorded for the extension, a built-in message announces the called party's name or extension number (if the name is not recorded).

InMail – Park and Page is available for all trunk calls that are redirected to voice mail via forwarding or overflow, including transferred calls, Direct Inward Lines, and Direct Inward Dialing. Park and Page is also available for Automated Attendant Screened (STRF) and Unscreened (UTRF) Transfers. Optionally, an extension can have calls from the Automated Attendant immediately Park and Page without trying their extension first.

When InMail – Park and Page intercepts the call, it normally offers the caller three options:

1. Dial **1** to leave a message in the called extension's mailbox.  
(The caller hears the mailbox Greeting, if recorded.)
2. Dial **2** to Park and Page.  
(The caller returns to these options if the Park is not picked up.)
3. Dial **3** to have the system try and locate this person.  
(The Find-Me Follow-Me feature returns the caller to these options if the user is not located.)
4. Dial **4** for other options.  
(Normally, this routes to the extensions Next Call Routing Mailbox).

InMail – Park and Page is available at Personal and Group Subscriber Mailboxes, and can be enabled through system programming or via the subscriber's Mailbox Options Menu. InMail – Park and Page is not applicable to Intercom calls.

### **Automated Attendant Direct to Voice Mail (DVM)**

When an extension has Automated Attendant Direct to Voice Mail (DVM) enabled, all calls from the Automated Attendant go directly to the subscriber's mailbox. The extension does not ring for Automated Attendant calls. The caller hears the mailbox greeting and can leave a message, but unlike Park and Page is not normally offered any other routing options. A subscriber typically turns on DVM when they need to work at their desk undisturbed by outside calls from the Automated Attendant.

DVM can be enabled by the installer from system programming or by the extension user from their Mailbox Options Menu.

Keep in mind that DVM does *not* block Intercom calls from co-workers or any other outside call not routed through the Automated Attendant. For example, with DVM enabled, Direct Inward Lines and transferred outside calls to an extension work normally.

## Conditions

- The Park and Page feature uses the extensions personal park location only.
- Enabling Automated Attendant Direct to Voice Mail (DVM) for a mailbox bypasses the Park and Page feature.
- The Park and Page feature uses the All Zone paging only; this cannot be changed or configured.
- Virtual extensions are not supported for Park and Page.

## Default Settings

Park and Page and Automated Attendant Direct to Voice Mail are disabled.

For transferred outside calls, direct inward lines and direct inward dialing refer to [Table 2-45 Park and Page Call Handling](#).

Table 2-45 Park and Page Call Handling

Park and Page (Call Handling) For Transferred Outside Calls, Direct Inward Line and Direct Inward Dialing			
47-02-14: Next Call Routing Mailbox	47-02-13: Dialing Option	47-02-17: Enable Park and Page	Result
Undefined	0 (No)	0 (No)	If unanswered, caller hears greeting and can leave a message.
Undefined	0 (No)	1 (Yes)	If unanswered, caller can dial 1 to leave a message or 2 to Park and Page.
Undefined	1 (Yes)	0 (No)	If unanswered, caller hears greeting and can leave a message.
Undefined	1 (Yes)	1 (Yes)	If unanswered, caller can dial 1 to leave a message or 2 to Park and Page.
Defined	0 (No)	0 (No)	If unanswered, caller hears greeting and can leave a message.
Defined	0 (No)	1 (Yes)	If unanswered, caller can dial 1 to leave a message, 2 to Park and Page, and 3 for other options (from the Next Call Routing Mailbox).
Defined	1 (Yes)	0 (No)	If unanswered, caller hears greeting, can leave a message, and dial options (from the Next Call Routing Mailbox).

Table 2-45 Park and Page Call Handling (Continued)

Park and Page (Call Handling) For Transferred Outside Calls, Direct Inward Line and Direct Inward Dialing			
47-02-14: Next Call Routing Mailbox	47-02-13: Dialing Option	47-02-17: Enable Park and Page	Result
Defined	1 (Yes)	1 (Yes)	If unanswered, caller can dial: 1 to leave a message, 2 to Park and Page, 3 to have the system try and locate the user and 4 for other options (from the Next Call Routing Mailbox).

For automated attendant unscreened (UTRF) and screened (STRF) transfers refer to [Table 2-46 Park and Page Call Handling](#).

Table 2-46 Park and Page Call Handling

Park and Page (Call Handling) For Automated Attendant Unscreened (UTRF) and Screened (STRF) Transfers			
47-02-17: Enable Park and Page	47-02-18: Paging Option	47-02-09: Auto Att Direct to VM	Result
0 (No)	0 (RNA)	0 (No)	If unanswered, caller hears greeting and can leave a message.
0 (No)	0 (RNA)	1 (Yes)	Caller immediately hears greeting and can leave a message.
0 (No)	1 (IMM)	0 (No)	If unanswered, caller hears greeting and can leave a message. <sup>1</sup>
0 (No)	1 (IMM)	1 (Yes)	Caller immediately hears greeting and can leave a message.
1 (Yes)	0 (RNA)	0 (No)	<u>STRF</u> : If unanswered, caller hears greeting and can leave a message. <sup>1</sup> <u>UTRF</u> : If unanswered, caller can dial 1 to leave a message or 2 to Park and Page. <sup>1</sup>
1 (Yes)	0 (RNA)	1 (Yes)	Caller immediately hears greeting and can leave a message.
1 (Yes)	1 (IMM)	0 (No)	Park and Page occurs immediately.
1 (Yes)	1 (IMM)	1 (Yes)	Caller immediately hears greeting and can leave a message.

<sup>1</sup> For an Unscreened Transfer (UTRF) with a Next Call Routing Mailbox assigned, caller can dial 1 to leave a message, 2 to Park and Page, and 4 for other options.

## System Availability

### Terminals

All Terminals

### Required Component(s)

- 1012 – SV9100 InMail VM Box Lic
- 0411 – SV9100 Version Lic (R1)
- 1001 – SV9100 InMail VRS Port Lic

## Related Features

➔ **Paging, Internal**

➔ **Park**

## Guide to Feature Programming

The **Level 1**, **Level 2** and **Level 3** columns indicate the programs that are assigned when programming this feature in the order they are most commonly used. These levels are used with PCPro and WebPro wizards for feature programming.

- Level 1 – these are the most commonly assigned programs for this feature.
- Level 2 – these are the next most commonly assigned programs for this feature.
- Level 3 – these programs are not often assigned and require an expert level working knowledge of the system to be properly assigned.

### Setting Up Park and Page for Extension:

Program Number	Program Name/Description	Input Data	Default	Level		
				1	2	3
47-02-09	<b>SV9100 InMail Station Mailbox Options – Auto Attendant Direct to Voice Mail</b> Enable/Disable Auto Attendant Do Not Disturb. When a subscriber enables this option, an Automated Attendant caller routes directly to the mailbox. For Subscriber Mailboxes you should enable this option. For Guest Mailboxes you should disable this option.	0 = Disable 1 = Enable	0			✓



Program Number	Program Name/Description	Input Data	Default	Level		
				1	2	3
47-02-14	<b>SV9100 InMail Station Mailbox Options – Next Call Routing Mailbox</b> Assign a Next Call Routing Mailbox to the Subscriber Mailbox. This provides callers with additional dialing options while listening to a subscriber Mailbox recording or default greeting. The digits the caller can dial depend on the setting of the Next Call Routing Mailbox and Alternate Next Call Routing Mailbox options.	1 ~ 32	(default = 1) By default Call Routing Mailboxes numbers are 01 ~ 08.	✓		
47-02-17	<b>SV9100 InMail Station Mailbox Options – Enable Paging</b> Enable the paging option for the appropriate mailbox. This call can also be changed via telephone in the extension's mailbox options.	0 = Disabled 1 = Enabled	0	✓		
47-02-18	<b>SV9100 InMail Station Mailbox Options – Paging Option</b> Determine if calls from auto attendant ring the phone first or go directly to the Park and Page feature options. This setting can be overridden by Program 47-02-09.	0 = RNA (Ring No Answer) 1 = Immediately	0	✓		

**Setting Up Park and Page for a Group Mailbox:**

Program Number	Program Name/Description	Input Data	Default	Level		
				1	2	3
47-06-07	<b>Group Mailbox Subscriber Options – Auto Attendant Do Not Disturb</b> Enable/Disable Auto Attendant Direct to VM. When enabled, an Auto Attendant caller routes directly to the mailbox, hears the greeting, and is asked to leave a message. A subscriber can enable this option while recording their mailbox greeting.	0 = Disable 1 = Enable	0			✓
47-06-12	<b>Group Mailbox Subscriber Options – Next Call Routing Mailbox</b> Assign a Next Call Routing Mailbox to the Subscriber Mailbox. This provides additional dialing option while listening to a Subscribe Mailbox recording or default greeting. The digits the caller can dial depends on the setting of the Next Call Routing Mailbox or alternate Next Call Routing Mailbox options.	1 ~ 32	(default = 1) By default Call Routing Mailboxes numbers are 01 ~ 16.	✓		
47-06-15	<b>Group Mailbox Subscriber Options – Enable Paging</b> Enable the paging option for the appropriate Group Mailbox. This call can be changed via telephone in the extension mailbox options.	0 = Disable (No) 1 = Enable (Yes)	0	✓		

Program Number	Program Name/Description	Input Data	Default	Level		
				1	2	3
47-06-16	<b>Group Mailbox Subscriber Options – Paging Option</b> Determine if calls from auto attendant ring the Group first or go directly to the Park and Page feature options. This setting can be overridden by Program 47-06-07.	0 = RNA (Ring No Answer) 1 = Immediate	0	✓		

## Operation

To record your paging message refer to [Table 2-47 Recording Your Paging Message](#).

Table 2-47 Recording Your Paging Message

Recording Your Paging Message				In these Instructions: [Telephone Softkey]
<b>To record your Paging Message:</b>				
1.	<b>Log onto your Subscriber Mailbox.</b>			
2.	[More> + More> + Page]	<b>Select Paging Message.</b> ○ Alternately dial <b>PG</b> (74).		
3.	<b>Do one of the following:</b>			
	a.	[Lstn]	<b>Select to listen to the current Paging Message (if any).</b> ○ Alternately dial <b>L</b> (5).	
		#	<b>Exit the listen mode.</b>	
	b.	[Rec]	<b>Select to record the Paging Message.</b> ○ Alternately dial <b>R</b> (7).	
		[Pause]	<b>Select to pause recording.</b> ○ Alternately dial <b>*</b> .	
		[Resume]	<b>Select to resume recording (if paused).</b> ○ Alternately dial <b>*</b> .	
		[Cncl]	<b>Select to erase the recording.</b> ○ Alternately dial <b>E</b> (3).	
		[Done]	<b>Select to confirm the recording and exit the recording mode.</b> ○ Alternately dial <b>#</b> .	
	c.	[Del]	<b>Select to erase the Paging Message.</b> ○ Alternately dial <b>E</b> (3).	
	d.	[Back]	<b>Select to go back to the Mailbox Main Menu.</b> ○ Alternately dial <b>#</b> .	

To set your call handling options refer to [Table 2-48 Setting the Call Handling Options](#).

Table 2-48 Setting the Call Handling Options

Recording Your Paging Message		In these Instructions: [Telephone Softkey]
<b>To set your Call Handling options:</b> <input type="radio"/> This includes Automated Attendant Direct to Voice Mail as well as Park and Page.		
1.	<b>Log onto your Subscriber Mailbox.</b>	
2.	[More> + Setup]	<b>Select Mailbox Options. (You are at the Mailbox Options Menu).</b> <input type="radio"/> Alternately dial <b>OP</b> (67).
	[CallH]	<b>Select Call Options. (You are at the Call Handling Options Menu).</b> <input type="radio"/> Alternately dial <b>CO</b> (26).
3.	<b>Do one of the following:</b>	
a.	[DVM]	<b>Select to turn Automated Attendant Direct to Voice Mail on or off.</b> <input type="radio"/> Alternately dial <b>O</b> (6).
	[Paging]	<b>Select to turn Park and Page on or off.</b> <b>Alternately dial E (3).</b>
	[Back]	<b>Select to go back to the Mailbox Options Menu.</b>

To retrieve a call parked in a personal parked orbit refer to [Table 2-49 Picking Up a Parked Call](#).

Table 2-49 Picking Up a Parked Call

Picking Up a Parked Call		In these Instructions: [Telephone Softkey]
<b>To retrieve a call parked in a Personal Orbit:</b>		
1.	<b>Dial **.</b>	
2.	<b>Dial the number of the extension at which the call is parked.</b>	

## *InMail – Upload Download Audio*

### Description

The InMail – Upload Download Audio feature allows the upload of mailbox greetings up to 1MB in size, recorded on a PC or professionally, to any valid subscriber mailbox in the system. It also allows users to listen to, download and/or delete voice mail messages from callers. Access to the InMail compact flash drive is via the HTML User Pro (WebPro).

### Audio Prompt Format

In order for uploaded greetings to properly play on the InMail they must be in the proper format. Audio files not recorded in the proper format may not playback on the InMail. The proper format is:

Bit Rate	64kbps
Sampling Size	8 bits
Channel	1 (Mono)
Sampling Rate	8 KHz
Audio Format	CCiTT u-law

### User Pro Access Options

There are two different User Pro logins available to make changes. To login, open an Internet browser and enter the IP of the SV9100 LAN port in the address line. At default, the IP address is 192.168.0.10.

**User Admin Mode (UA Mode):** This mode allows the user admin to access any telephone and mailbox in the system. This mode must be used to change VRS and Routing Mailbox greetings. At default the login ID is USER1 and the password is 1111.

**User Mode (UB Mode):** This mode allows a user to access only their own telephone and mailbox when logged in. They will not be able to change any other telephone, mailbox, VRS or Routing Mailbox. At default the login ID is the “Extension Number” and the password is 1111.

The following details the page layout diagram of the two different User Pro login IDs:

Figure 2-33 InMail User Pro Login Diagram

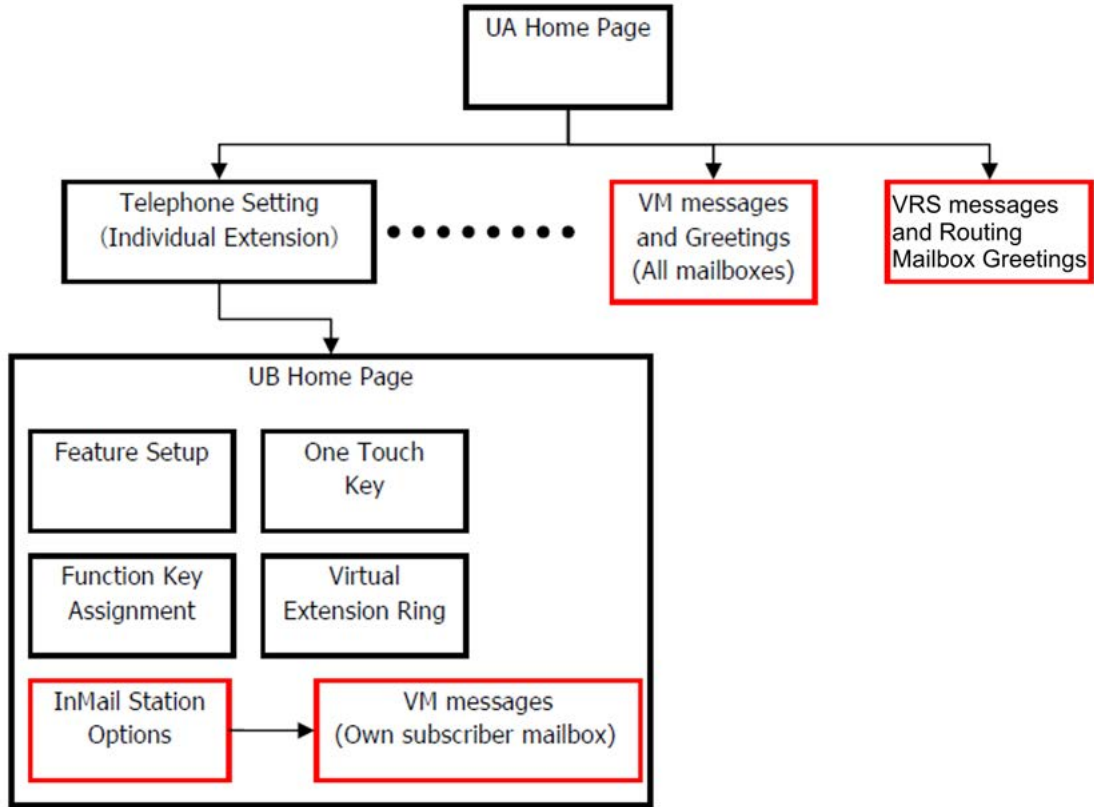

### Message Name Format

Downloaded messages are automatically assigned a name by the SV9100. This name includes the mailbox number the message was left in, type of message, the message number and the date and time to the second the message was left. The table below shows how to interpret the message name to determine this information.

Table 2-50 Default Incoming Ringing Tone

File Name Format	BTNNN_YYYYMMDD_HHMMSS.wav (maximum 32 characters)
B	Mailbox number (maximum eight digits) or VRS for the VRS message
T	Message Type + : Greeting or VRS message - : Recorded message
NNN	Message number (three digits)
YYYY	Year

Table 2-50 Default Incoming Ringing Tone (Continued)

File Name Format	BTNNN_YYYYMMDD_HHMMSS.wav (maximum 32 characters)
MM	Month (1~12)
DD	Date (1~31)
HH	Hour (00~23)
MM	Minute (00~59)
SS	Second (0 ~59)

## Conditions

- Uploading audio files to any type of Call Routing box and Group mailboxes is supported. Auto attendant and group mailbox greetings can be uploaded or deleted using End User WebPro interface with the UA login.
- VRS and InMail messages are recorded in an ADPCM format which may not be easily opened on the support PC.
- It is not possible to upload/download/delete multiple files simultaneously.
- The mailbox will be inaccessible from the telephone under these conditions:
  - ❑ Mailbox XXX will not be accessible when opening the telephone setup screen of extension XXX by UA or UB mode in User Pro.
  - ❑ Mailbox XXX will not be accessible when selecting the extension XXX on the file upload/download screen of UA mode User Pro.
  - ❑ Mailbox XXX will be inaccessible when logging in the UB mode User Pro for extension XXX.
- While uploading an audio file via User Pro the greeting is not accessible by telephone.
- When downloading/deleting an audio file via User Pro, the file is not accessible by another User Pro session or from the telephone.
- This feature is only supported using a LAN connection.
- When uploading an audio file the extension will be checked whether it is WAV or not. However, the format of the uploaded file will not be checked. If the uploaded file is not in the proper format it may not playback properly.
- When a mailbox has a new message and the message is downloaded using the User Pro interface, the MWI of the mailbox will NOT be canceled. If the message is deleted from User Pro the MWI is turned off.
- The largest allowed upload file size is approximately 1MB. Files larger than this cannot be uploaded.
- There is no size limitation when downloading audio files.

- User Pro does not check the uploaded file for correct naming format (i.e., BTNNN\_YYYYMMDD\_HHMMSS.wav). The file name will be automatically changed when the file is written in the CF.
- The actual file name of the messages is not displayed in User Pro. The message number, modified date and file size are displayed instead. If there is no message file, “-” will be displayed and the download/delete icon will not be displayed.
- The User Pro message page does not refresh automatically, to see new messages the page must be refreshed. For instance, if a new message is received via regular operation on the system while a user is viewing the upload/download screen, the new message is not shown until the page is reloaded by clicking the  icon.
- At default, Microsoft Windows will automatically open and play the downloaded WAV. To make **Open** or **Save** selectable, the following settings are required:
  - Windows XP
    1. Select **Control Panel** then **Folder Options**.
    2. Click on the **Files** tab.
    3. Select the **WAV** extension from the list, then click **Advanced**.
    4. Check **Confirm to open the file after download**, then click **OK**.
    5. Close the folder option by clicking **OK** again.
  - Windows Vista: It is not possible to change the save to folder option. The downloaded file is automatically opened for playback.

## Default Settings

None

## System Availability

### Terminals

All Terminals

### Required Component(s)

- 1012 – SV9100 InMail VM Box Lic
- 0411 – SV9100 Version Lic (R1)

## Related Features

- ➔ **InMail**
- ➔ **Voice Response System (VRS) Upload Download Audio**

## Guide to Feature Programming

The **Level 1**, **Level 2** and **Level 3** columns indicate the programs that are assigned when programming this feature in the order they are most commonly used. These levels are used with PCPro and WebPro wizards for feature programming.

- Level 1 – these are the most commonly assigned programs for this feature.s
- Level 2 – these are the next most commonly assigned programs for this feature.
- Level 3 – these programs are not often assigned and require an expert level working knowledge of the system to be properly assigned.

Program Number	Program Name/Description	Input Data	Default	Level		
				1	2	3
90-02-01	<b>Programming Password Setup – User Name</b> Set the system passwords.	Maximum of 10 characters.	Refer to the Programming Manual for default values.		✓	
90-02-02	<b>Programming Password Setup – Password</b> Configure the administrator accounts that are used when connecting to the KTS via PCPro/ WebPro. If using PCPro, these are the accounts that are used to <i>connect</i> . If using WebPro, these are the accounts that are used to login.	Maximum of eight digits.	Refer to the Programming Manual for default values.		✓	
90-02-03	<b>Programming Password Setup – User Level</b> Set the system password user levels.	0 = Prohibited User 1 = MF (Manufacturer Level) 2 = IN (Installer Level) 3 = SA (System Administrator Level 1) 4 = SB (System Administrator Level 2) 5 = UA (User Programming Level 1)	Refer to the Programming Manual for default values.		✓	



**Troubleshooting**

The table below shows possible Error messages and Causes:

*Table 2-51 Error Messages and Causes*

Error Message	Cause
Mailbox XXX does not exist. (XXX = mailbox number)	The mailbox does not exist
The mailbox is being used by another session	When the mailbox is being used by another session, either PC or telephone.
There is no available space in the SD.	When there is no available space in the SD.
The file is being used by another session. Please try again later.	When the file to be downloaded is being used by another session, either PC or telephone.
The selected file has already been deleted.	When the file selected for download has already been deleted.
The file is being used by another session. Please try again later.	When the file selected for deletion is being used by another session.
The selected file has already been deleted.	When the file selected for deletion has already been deleted.
Cannot upload the file since the original file is being used by another session. Please try again later.	When the file to be replaced is being used when trying to upload the replacement.

**Operation**

**Listening to Voice Mail Messages using User Admin Mode (UA):**



*All messages stored on the InMail can be accessed via the Mailbox User Mode for playback or deletion.*

NOTE

1. To login, open an Internet browser and enter the IP of the SV9100 LAN port in the address line. At default, the IP address is 192.168.0.10.
2. At the login screen enter username = USER1 and password = 1111.
3. You will then see the main menu, click on the InMail Audio Up/Download icon.
4. Choose the extension number to be changed and make sure Audio Data is set to Incoming Messages.
  - ◇ *The message numbers correspond to the same message number when accessed via the telephone. Message 1 is the first message, message 2 is the second message, etc.*
5. To delete a message, click on the red X to the right of the appropriate message.

6. To listen to a message:
  - Click on the download icon to the right of the message you want to hear.
  - Depending on browser settings, a security prompt may appear.
  - Click on the menu and choose to allow the file to download.
  - Depending on Windows configuration, you may be prompted again to either Open or Save the message. To listen, click Open and the default WAV file player will play the message. To save the message, click on the Save icon and browse to the location where the message will be saved on a local PC.

### Listening to Voice Mail Messages using Mailbox User Mode (UB):

1. To login, open an Internet browser and enter the IP of the SV9100 LAN port in the address line. At default, the IP address is 192.168.0.10.
2. At the login screen enter username = Extension Number and password = 1111.
3. You will then see the main menu, click on the InMail Audio Up/Download icon.
  - ◇ *The message numbers correspond to the same message number when accessed via the telephone. Message 1 is the first message, message 2 is the second message, etc.*
4. To delete a message, click on the red X to the right of the appropriate message.
5. To listen to a message:
  - Click on the download icon to the right of the message you want to hear.
  - Depending on browser settings, a security prompt may appear.
  - Click on the menu and choose to allow the file to download.
  - Depending on Windows configuration, you may be prompted again to either Open or Save the message. To listen, click Open and the default WAV file player will play the message. To save the message, click on the Save icon and browse to the location where the message will be saved on a local PC.

### Changing Mailbox Greetings using User Admin Mode (UA):

Audio files up to 1MB may be uploaded to the InMail for any mailbox greeting. In order for uploaded greetings to play on the InMail they must be in the proper format. Audio files not recorded in the proper format may not playback on the InMail. The proper format is:

Bit Rate	64kbps
Sampling Size	8 bits
Channel	1 (Mono)
Sampling Rate	8 KHz
Audio Format	CCiTT u-law

1. To login, open an Internet browser and enter the IP of the SV9100 LAN port in the address line. At default, the IP address is 192.168.0.10.
2. At the login screen enter username = USER1 and password = 1111.

3. You will then see the main menu, click on the InMail Audio Up/Download icon.
4. Choose the extension number to be changed and make sure Audio Data is set to Incoming Messages.
  - ◇ *The greeting numbers correspond to the same greeting number when accessed via the telephone. Greeting 1 is GR1, greeting 2 is GR2 and greeting 3 is GR3. Greeting 7 is the paging greeting used with the park and page feature.*
5. To delete a greeting, click on the red X to the right of the appropriate greeting.
6. To upload a greeting:
  - Under Message No, enter the greeting number to be replaced on the voice mail.
  - Browse to find the location where the greeting file is stored.
  - Click on the upload icon to the right of the selected file name.
  - Depending on file size and LAN speed, it may take several minutes to upload the greeting.
  - The uploaded greeting will appear in the assigned location.

**Changing Mailbox Greetings using Mailbox User Mode (UB):**

Audio files up to 1MB may be uploaded to the InMail for any mailbox greeting. In order for uploaded greetings to play on the InMail they must be in the proper format. Audio files not recorded in the proper format may not playback on the InMail. The proper format is:

Bit Rate	64kbps
Sampling Size	8 bits
Channel	1 (Mono)
Sampling Rate	8 KHz
Audio Format	CCiTT u-law

1. To login, open an Internet browser and enter the IP of the SV9100 LAN port in the address line. At default, the IP address is 192.168.0.10.
2. At the login screen enter username = Extension Number and password = 1111.
3. You will then see the main menu, click on the InMail Audio Up/Download icon.
  - ◇ *The greeting numbers correspond to the same greeting number when accessed via the telephone. Greeting 1 is GR1, greeting 2 is GR2 and greeting 3 is GR3. Greeting 7 is the paging greeting used with the park and page feature.*
4. To delete a greeting, click on the red X to the right of the appropriate greeting.
  - Under Message No, enter the greeting number to be replaced on the voice mail.
  - Browse to find the location where the greeting file is stored.
  - Click on the upload icon to the right of the selected file name.
  - Depending on file size and LAN speed, it may take several minutes to upload the greeting.
  - The uploaded greeting will appear in the assigned location.

## Instant Access Application (IAA)

### Description

The Instant Access Application (IAA) feature is a server based XML application that allows NEC IP display phones (DT710/DT730/DT730G/DT750) access to the following options and features:

- Voice Mail
- Speed Dial
- News (RSS News)
- Weather
- Photo
- RSS Photo
- Calendar
- Banner
- Sub Banner text
- Screen Saver
- Icon Position
- Mascot Greeting
- Widget

### Conditions

- Speed Dial only supports a single number.
- The Photo displayed in the News (RSS News) feed is only supported on the DT750 and ITL-12CG terminals.
- The DT730, ITL-12DG and ITL-8LDE do not support the IAA Calendar.
- Sub Banner text can only be displayed in the Retro mode.
  - ◇ *The Sub Banner text feature is not supported on the DT730, ITL-12DG and ITL-8LDE terminals.*
- Mascot Greeting is only displayed in the Retro mode.
  - ◇ *The Mascot Greeting feature is only supported on the ITL-12CG terminal.*
- The DT730, ITL-12DG and ITL-8LDE terminals do not support the IAA Widget display.
- If the Voice Mail type is InMail, mailbox integration is not supported when pressing the VM icon. The user must enter the extension number or use the VMsg softkey.

- The IAA URL should be configured under the “Home URL” terminal XML configuration. The IAA application will not function correctly if the IAA URL is configured in the “Service URL” setting parameter of the terminal.
- RSS subscriptions to third party news sources such as Yahoo can be terminated at any time and without notice.
- Defining IAA conditions through the menu operation are stored in volatile memory and as such this information is automatically erased when the terminal is initialized. In order to prevent the IAA configuration from being erased from the terminal, NEC recommends that configuration assignment through the URL setting be set and stored under the “Home URL” terminal XML configuration.
- General maintenance on the IAA server may be performed as needed and especially after normal business hours (6PM to 5AM, USA Central Time). IAA is temporarily unavailable during maintenance.
- The response time to IAA feature activation/display is controlled by Internet speed and traffic content on the LAN. Due to this, response times for the IAA feature activation/display may vary.
- DT730 and DT750 terminals use TCP port 1024-5000.

DT730G (ITL-12CG/ITL-12DG) terminals use TCP port 32768-61000.

If these port numbers are used by different applications in network, the terminal cannot receive XML data from the IAA cloud server.

Table 2-52 DT700 Series Supported Features (IAA)

Feature	Mode	DT750	DT730	DT730G (ITL-12CG)	DT730G (ITL-12DG)	DT710 (ITL-8LDE)
Voice Mail	All	X	X	X	X	X
Speed Dial (SV9100)	All	X	X	X	X	X
Call Forward	All	X	X	X	X	X
History/DIR	All	X	X	X	X	X
News (RSS News)	All	X	X	X	X	X
Photo in News	All	X	N/A	X	N/A	N/A
Weather	All	X	X	X	X	X
Photo	All	X	X	X	X	X
RSS Photo	All	X	N/A	X	N/A	N/A
Calendar	All	X	N/A	X	N/A	N/A
Banner	All	X	X	X	X	X
Screen Saver	All	X	X	X	X	X
Icon Position	Retro	X	X	X	X	X
UCE UC XML	All	X	X	X	X	X

Table 2-52 DT700 Series Supported Features (IAA) (Continued)

Feature	Mode	DT750	DT730	DT730G (ITL-12CG)	DT730G (ITL-12DG)	DT710 (ITL-8LDE)
Mascot Greeting	All	X	N/A	X	N/A	N/A
Modern Design	Modern	X	N/A	X	N/A	N/A
Splash Screen	All	X	N/A	X	N/A	N/A
Instruction	All	X	X	X	X	X
Widget	All	X	N/A	X	N/A	N/A

### Default Settings

None

## System Availability

### Terminals

- DT710 (ITL-8LDE) with firmware **5.0.4.0 or higher** installed.
- DT730 (ITL-8LD, ITL-12D, ITL-24D, ITL-32D, ITL-12PA) with firmware **5.0.4.0 or higher** installed.
- DT730G (ITL-12CG and ITL-12DG) with firmware **1.0.2.0 or higher** installed.
- DT750 (ITL-320C) with firmware **5.0.4.0 or higher** installed.

### Required Component(s)

- IP Phone Manager **6.1.0 or higher** must be installed.
- FTP or TFTP server application must be installed.

## Related Features

↳ **SV9100 Terminals**

## Programming

None

## Operation



REFERENCE

*Refer to the Instant Access Application User Guide for detailed feature information.*

## Description

Intercom gives extension users access to other extensions. This provides the system with complete internal calling ability.

### Handsfree Answerback/Forced Intercom Ringing

Handsfree Answerback permits an extension user to respond to a voice-announced Intercom call by speaking toward the telephone, without lifting the handset. Like Handsfree, this is a convenience for workers who do not have a free hand to pick up the handset. Refer to [Handsfree Answerback/Forced Intercom Ringing on page 2-603](#) feature for more information.

### Busy Status Display

When a display multiline terminal user places an Intercom call to a busy extension, the details of the busy status (who is talking to the extension or which line is in use by the extension) can be displayed. The details of the trunk busy status (the extension using the line) can be displayed after trying to access the trunk. This feature provides a user information which can determine whether they should use Barge-In for the extension or trunk. This information automatically displays for a multiline terminal once programmed.

## Conditions

- Preventing ICM calls does not affect dialing other service codes, including 911.
- Intercom calls can ring or be voice-announced at the called extension.
- Ringing Line Preference can automatically answer ringing Intercom or trunk calls when the user lifts the handset.
- An extension can have a name assigned that identifies the extension to callers.
- Dialing 9 or any other trunk access code after dialing a busy extension results in termination of the Intercom call and seizing a trunk.
- For a station to retrieve a held ICM call, the station must have an ICM key assigned in Program 15-07 (\*00).
- A special ringtone is provided when a pre-assigned extension places an Intercom call.
- The incoming ringtone from a pre-assigned extension (set in Program 15-01-13) is limited to calls to the actual extension, not the Virtual Extension. Incoming calls to the VE follows Program 15-08-1 settings.

## Default Settings

Enabled



## System Availability

### Terminals

All Terminals

### Required Component(s)

None

## Related Features

- ↳ [Handsfree Answerback/Forced Intercom Ringing](#)
- ↳ [Intercom](#)
- ↳ [Line Preference](#)
- ↳ [Name Storing](#)

## Guide to Feature Programming

The **Level 1**, **Level 2** and **Level 3** columns indicate the programs that are assigned when programming this feature in the order they are most commonly used. These levels are used with PCPro and WebPro wizards for feature programming.

- Level 1 – these are the most commonly assigned programs for this feature.
- Level 2 – these are the next most commonly assigned programs for this feature.
- Level 3 – these programs are not often assigned and require an expert level working knowledge of the system to be properly assigned.

Program Number	Program Name/Description	Input Data	Default	Level		
				1	2	3
11-11-13	<b>Service Code Setup (for Setup/Entry Operation) – Display Language Selection for Multiline Terminal</b> Select the service code used at an extension to change the displayed language on a multiline terminal display.	MLT 0 ~ 9, *, # Maximum of eight digits	678		✓	

Program Number	Program Name/Description	Input Data	Default	Level		
				1	2	3
15-01-13	<p><b>Basic Extension Data Setup – Special Ringtone Choice</b></p> <p>Use to select the special incoming ring tone for the extension. When called from this Program on the set extension, the called extension rings with the selected ring tone.</p>	0 = Incoming Extension Ringtone 1 = Tone Pattern 1 2 = Tone Pattern 2 3 = Tone Pattern 3 4 = Tone Pattern 4 5 = Tone Pattern 5 6 = Tone Pattern 6 7 = Tone Pattern 7 8 = Tone Pattern 8	0		✓	
15-02-01	<p><b>Multiline Telephone Basic Data Setup – Display Language Selection</b></p> <p>Select the language to be displayed on a multiline terminal display.</p>	0 = Japanese 1 = English 2 = German 3 = French 4 = Italian 5 = Spanish 6 = Dutch 7 = Portuguese 8 = Norwegian 9 = Danish 10 = Swedish 11 = Turkish 12 = Latin American Spanish 13 = Romanian 14 = Polish	1		✓	
20-06-01	<p><b>Class of Service for Extensions</b></p> <p>Assign Class of Service (1 ~ 15) for extensions.</p>	Day Night/Mode: 1 ~ 8 Class of Service of Extensions (1 ~ 15)	Extension port 101 = Class 15 All other extension port = Class 1	✓		
20-08-01	<p><b>Class of Service Options (Outgoing Call Service) – Intercom Calls</b></p> <p>Turn Off or On Intercom calling for the extension.</p>	0 = Off 1 = On	COS 1 ~ 15 = 1		✓	
20-08-11	<p><b>Class of Service Options (Outgoing Call Service) – Protect for the Call Mode Switching from Caller</b></p> <p>When an extension is set to ring mode for ICM calls, enable this option to prevent callers from changing the call to voice announce mode.</p>	0 = Off 1 = On	COS 1 ~ 15 = 0		✓	
20-11-07	<p><b>Class of Service Options (Hold/Transfer Service) – Transfer Without Holding</b></p> <p>Turn Off or On an extension user ability to use Transfer Without Holding.</p>	0 = Off 1 = On	COS 1 ~ 15 = 0		✓	
20-13-22	<p><b>Class of Service Options (Supplementary Service) – Busy Status Display (Called Party Status)</b></p> <p>Turn Off or On an extension user ability to display the detailed state of the called party.</p>	0 = Off 1 = On	COS 1 ~ 15 = 0		✓	

Program Number	Program Name/Description	Input Data	Default	Level		
				1	2	3
20-17-01	<b>Operator Extension – Operator’s Extension Number</b> Define the extension numbers used by operators.	Maximum of eight digits	101		✓	
20-18-01	<b>Service Tone Timers – Extension Dial Tone Time</b> After getting Intercom dial tone, a multiline terminal user has this time to dial the first digit of the Intercom call.	0 ~ 64800 seconds	30		✓	
21-01-02	<b>System Options for Outgoing Calls – Intercom Interdigit Time</b> When placing Intercom calls, an extension user must dial each digit during this time.	0 ~ 64800 seconds	10		✓	
82-01-01 (01)	<b>Incoming Ring Tone – Frequency 1</b> Customize the Intercom ring tone.	1 = 520Hz 2 = 540Hz 3 = 660Hz 4 = 760Hz 5 = 1100Hz 6 = 1400Hz 7 = 2000Hz	Refer to <a href="#">Table 2-53 Default Incoming Ringing Tone on page 2-769</a> .		✓	
82-01-02	<b>Incoming Ring Tone – Frequency 2</b> Customize the Intercom ring tone.	1 = 520Hz 2 = 540Hz 3 = 660Hz 4 = 760Hz 5 = 1100Hz 6 = 1400Hz 7 = 2000Hz	Refer to <a href="#">Table 2-53 Default Incoming Ringing Tone on page 2-769</a> .			✓
82-01-03	<b>Incoming Ring Tone – Modulation</b> Customize the Intercom Ring Tone modulation if desired.	0 = No Modulation 1 = 8Hz Modulation 2 = 16Hz Modulation 3 = Envelope	2			✓

**Handsfree Answerback/Forced Intercom Ringing:**

Program Number	Program Name/Description	Input Data	Default	Level		
				1	2	3
11-11-15	<b>Service Code Setup (for Setup/Entry Operation) – Enable Handsfree Incoming Intercom Calls</b> Customize the enable handsfree incoming intercom calls used for registration and setup.	MLT 0 ~ 9, *, # Maximum of eight digits	721		✓	
11-11-16	<b>Service Code Setup (for Setup/Entry Operation) – Force Ringing of Incoming Intercom Calls</b> Customize the force ringing of incoming intercom calls used for registration and setup.	MLT 0 ~ 9, *, # Maximum of eight digits	723		✓	

Program Number	Program Name/Description	Input Data	Default	Level		
				1	2	3
20-02-12	<b>System Options for Multiline Telephones – Forced Intercom Ring (ICM Call Type)</b> Enable/Disable Forced Intercom Ringing. If enabled, Intercom calls normally ring. If disabled, intercom calls voice announce. For all NEC Cordless telephones, this option must be enabled since voice announce is not possible.	0 = Disable (Voice) 1 = Enable (Signal)	0		✓	
20-06-01	<b>Class of Service for Extensions</b> Assign Class of Service (1 ~ 15) for extensions.	Day Night/Mode: 1 ~ 8 Class of Service of Extensions (1 ~ 15)	Extension port 101 = Class 15 All other extension port = Class 1	✓		
20-08-10	<b>Class of Service Options (Outgoing Call Service) – Signal/Voice Call</b> Turn Off or On an extension ability to force Handsfree Answerback or Forced Intercom Ringing for outgoing Intercom calls.	0 = Off 1 = On	COS 1 ~ 15 = 1		✓	
20-09-05	<b>Class of Service Options (Incoming Call Service) – Signal/Voice Call</b> Turn Off or On an extension user ability to enable Handsfree Answerback or Forced Intercom Ringing for their incoming Intercom calls.	0 = Off 1 = On	COS 1 ~ 15 = 1	✓		
20-13-06	<b>Class of Service Options (Supplementary Service) – Automatic Off-Hook Signaling (Automatic Override)</b> Allow a busy extension user to Manually (0) or Automatically (1) receive off-hook signals. ➤ <i>This setting is to receive incoming call signaling information during call queuing.</i>	0 = Off 1 = On	COS 1 ~ 15 = 1	✓		
80-01-01 (28)	<b>Service Tone Setup – Tone 28 (Speaker Monitor Tone)</b> This tone changes the tone the originator of an ICM call hears. (The tone cannot be changed for what is heard by the user when receiving an ICM call.)	Service Tone #28	Refer to <a href="#">Table 2-33 Service Tone Setup Defaults, Program 80-01-01 on page 2-594.</a>		✓	
80-01-02	<b>Service Tone Setup – Basic Tone Number</b> Define up to 64 Service Tones. Each service tone is defined by the combination of 32 Basic Tones.	1 ~ 33 (0 = No Tone) (33 = Default Time Slot)	1~33 (0 = No Tone) (33=Default Time Slot) Refer to <a href="#">Table 2-34 Service Tone Setup, Program 80-01-02 on page 2-598.</a>			✓

Program Number	Program Name/Description	Input Data	Default	Level		
				1	2	3
82-01-01	<b>Incoming Ring Tone – Frequency 1</b> Customize the Intercom ring tone.	1 = 520Hz 2 = 540Hz 3 = 660Hz 4 = 760Hz 5 = 1100Hz 6 = 1400Hz 7 = 2000Hz	Default: Refer to <a href="#">Table 2-53 Default Incoming Ringing Tone on page 2-769</a> .			✓

Table 2-53 Default Incoming Ringing Tone

Incoming Ring Tone Number	Tone Type	Frequency 1	Frequency 2	Modulation
Pattern 1 (Trunk Incoming)	High Mid Low	1100 660 520	1400 760 660	16Hz Modulation 16Hz Modulation 16Hz Modulation
Pattern 2 (Trunk Incoming)	High Mid Low	1100 660 520	1400 760 660	8Hz Modulation 8Hz Modulation 8Hz Modulation
Pattern 3 (Trunk Incoming)	High Mid Low	2000 1400 1100	760 660 540	16Hz Modulation 16Hz Modulation 16Hz Modulation
Pattern 4 (Trunk Incoming)	High Mid Low	2000 1400 1100	760 660 540	8Hz Modulation 8Hz Modulation 8Hz Modulation
Pattern 5 Intercom Incoming Pattern	High Mid Low	1100 660 520	1400 760 660	8Hz Modulation 8Hz Modulation 8Hz Modulation
Pattern 6 Alarm Sensor Pattern	High Mid Low	760 760 760	760 760 760	No Modulation No Modulation No Modulation
Pattern 7 (Trunk Incoming)	High Mid Low	1400 760 660	540 540 540	16Hz Modulation 16Hz Modulation 16Hz Modulation
Pattern 8 (Trunk Incoming)	High Mid Low	1400 760 660	540 540 540	8Hz Modulation 8Hz Modulation 8Hz Modulation
Pattern 9 (Trunk Incoming)	High Mid Low	2000 2000 1100	1100 540 760	16Hz Modulation 16Hz Modulation 16Hz Modulation
Pattern 10 (Trunk Incoming)	High Mid Low	2000 2000 1100	1100 540 760	8Hz Modulation 8Hz Modulation 8Hz Modulation

## Operation

### To place an Intercom call:

1. At multiline terminal, press **Speaker**.

- OR -

At single line telephone, lift the handset.

2. Dial extension number (or **0** for your operator).
  - ◇ *Your call may voice-announce or ring the called extension. Dial 1 to change the way your call alerts the called extension.*
  - ◇ *If the extension you call is busy or does not answer, you can dial another extension without hanging up.*

### To answer an Intercom call:

1. If you hear two beeps, speak toward telephone.

◇ *Your telephone picks up your voice.*

- OR -

If your telephone rings, lift the handset.

### To check the extension data (multiline terminal only):

1. Press the **Help** key.
2. Dial the extension number.
  - ◇ *You display shows your telephone extension number, port number and extension/Department Group.*
  - ◇ *You can also check any other extension numbers information by pressing Help + the extension number.*
3. Press **Exit** to return the normal time/date display.

### To change how Intercom calls ring the extension:

1. Press **Speaker** or lift the handset.
2. Dial **723** to have calls ring your extension.
  - OR -
3. Dial **721** to have calls voice announce to your extension.

## Description

The InVPN Server is a VPN concentrator designed to allow UT880 or DT700 and DT800 telephones with IP6-L adapter to connect remotely to the local SV9100 network over the Internet. The InVPN Server is used to set up a VPN tunnel on a per phone basis for remote users to connect to the SV9100 without having to use NAT or port forwarding. A maximum of 100 simultaneous VPN client connections are supported per InVPN Server.

Figure 2-34 Example of InVPN Configuration

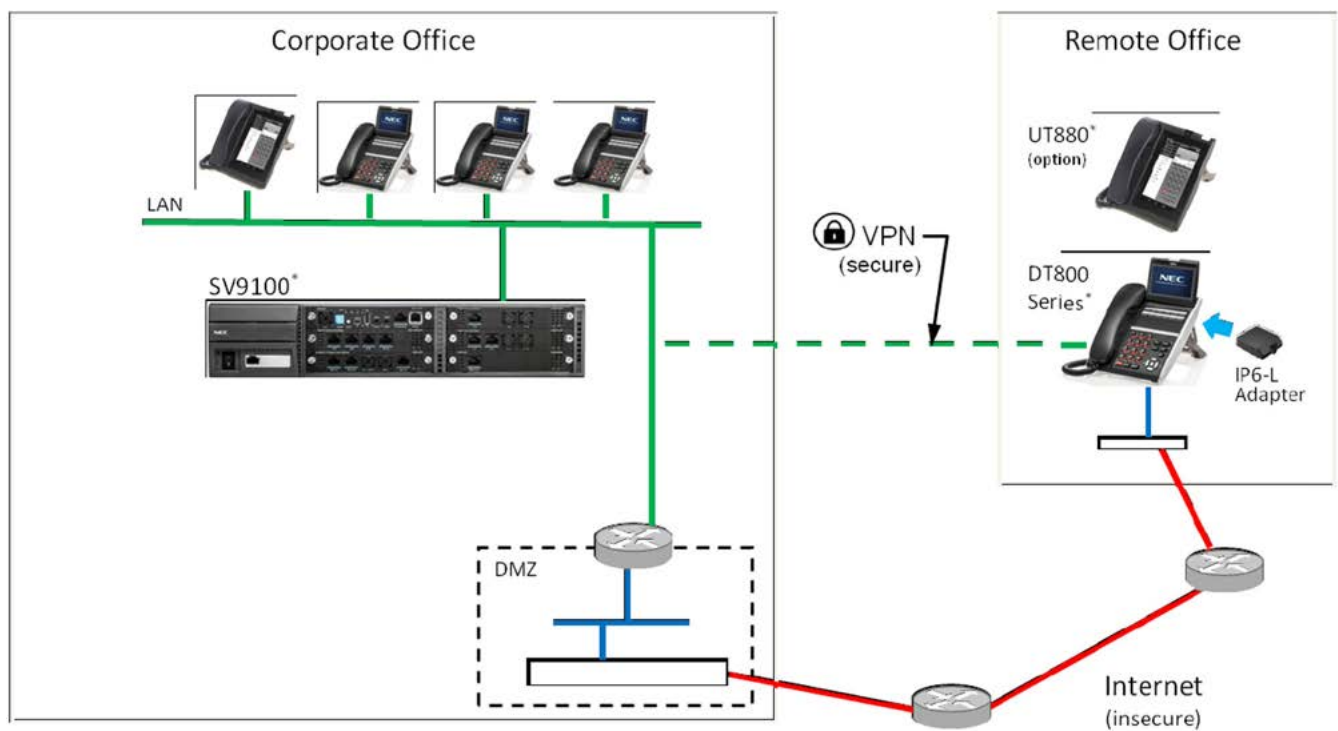

## Conditions

- The time and date of the IP6-L adapter must match the time and date of the InVPN when authenticating. A date range is specified when the certificate is created. The client must fall within that range to successfully log into the InVPN server.
- At default, the IP6-L obtains its time and date from **pool.ntp.org**. This destination must be allowed by the local router for the IP6-L to get the correct time and date.
- You must have two separately routed local networks for the InVPN. The WAN and LAN ports must reside on different networks.
- The InVPN cannot be connected directly to the Internet.

- You must set Program 15-05-50 (P2P Mode) to off (0) for every extension number that will be used for remote UT880 phones.
- The time and date of the UT880 must match the time and date of the InVPN when authenticating. A date range is specified when the certificate is created. The client must fall within that range to successfully log into the InVPN server.
- The local network router must have a static route mapped to the Android VPN network (Default: 10.253.166.0) via the InVPN Server LAN Port IP address.
  - ✎ *Without this setting in the local router/gateway UT880 VPN clients will not work.*
- If using system features such as NetLink, any remote system router will need to have a static route mapped to the Android VPN network (10.253.166.0) via the InVPN Server WAN Port IP address or the public Internet address mapped to the WAN Port.
  - ✎ *Without this setting in the remote router/gateway, UT880 VPN clients will not have voice path when calling remote system phones.*
- The InVPN supports up to 100 remote VPN client connections.
- Each remote VPN client requires a unique certificate. If the same certificate is used by more than one VPN client only the client that connected last will have connectivity.
- DSS Consoles are not supported for remote VPN Client devices.
- Remote IP phones require the same system licenses as local IP phones.
- UT880 terminals with the InVPN client, DT700 and DT800 phones with IP6-L adapters can connect to the InVPN.
- InVPN v1.02 or higher supports connections with Android devices using the OpenVPN client and Multiline Client Mobile.
- InVPN v1.02 or higher supports remote Windows PC VPN client connections using the OpenVPN client.
- InVPN v1.02 or higher supports connections with iOS devices using the OpenVPN client and Multiline Client Mobile. When creating iOS client certificates you must choose Windows Client.

## Default Settings

None

## System Availability

### Terminals

- UT880 with InVPN Client Application installed
- DT800 with IP6-L adapter



- DT700 with IP6-L adapter

**Required Component(s)**

- GCD-SVR2 with InVPN application
- GCD-CP10 with GPZ-IPLE Daughter Board installed
- 0411 – SV9100 Version Lic (R1)
- 0300 – SV9100 Resource Lic
- 5103 – SV9100 IP Resource Lic
- 5111 – SV9100 IP Phone Lic
- Local network system with at least two separately routed networks and Internet access.

**Related Features**

- ➔ [IP Multiline Station \(SIP\)](#)
- ➔ [IP Multiline Telephone \(UT880\)](#)

**Guide to Feature Programming**

The **Level 1**, **Level 2** and **Level 3** columns indicate the programs that are assigned when programming this feature in the order they are most commonly used. These levels are used with PCPro and WebPro wizards for feature programming.

- Level 1 – these are the most commonly assigned programs for this feature.
- Level 2 – these are the next most commonly assigned programs for this feature.
- Level 3 – these programs are not often assigned and require an expert level working knowledge of the system to be properly assigned.

Program Number	Program Name/Description	Input Data	Default	Level		
				1	2	3
10-12-01	<b>GCD-CP10 Network Setup – IP Address</b> Assign the IP Address.	0.0.0.0 ~ 126.255.255.254 128.0.0.1 ~ 191.255.255.254 192.0.0.1 ~ 223.255.255.254	192.168.0.10	✓		
10-12-03	<b>GCD-CP10 Network Setup – Default Gateway</b> Assign the default gateway IP address for the GCD-CP10.	0.0.0.0 ~ 126.255.255.254 128.0.0.1 ~ 191.255.255.254 192.0.0.1 ~ 223.255.255.254	0.0.0.0	✓		

Program Number	Program Name/Description	Input Data	Default	Level		
				1	2	3
10-12-09	<b>GCD-CP10 Network Setup – IP Address</b> Set IP address for GPZ-IPLE. ➡ <i>The IP Address assigned in Program 10-12-01 cannot start with the same leading digits as the IP Address assigned here.</i>	0.0.0.0 ~ 126.255.255.254 128.0.0.1 ~ 191.255.255.254 192.0.0.1 ~ 223.255.255.254	172.16.0.10	✓		
10-13-01	<b>DHCP Server Mode</b> Enable/Disable the built-in DHCP Server.	0 = Disable 1 = Enable	0			✓
10-13-02	<b>Lease Time</b> Lease time of the IP address to a client. Press the Transfer Key to increment to the next setting data.	Days 0 ~ 255 Hour 0 ~ 23 Minutes 0 ~ 59	0 day 0 hour 30 minutes			✓
10-13-05	<b>Last DHCP Data</b> If 10-13-01 is enabled, this setting determines if DHCP resource is enabled or disabled.	0 = Disable 1 = Enable	1			✓
10-19-01	<b>VoIP DSP Resource Selection</b> Select type of GPZ-IPLE DSP Resource. This program setting has no affect on the terminal/trunk port assignment or usage.	0 = Common use for both IP extensions and trunks 1 = IP Extension 2 = SIP Trunk 3 = CCIS/Networking 4 = Use for NetLink 5 = Blocked 6 = Common without Unicast Paging 7 = Multicast Paging 8 = Unicast Paging	Resource 1 = 1 Resource 2-256 = 0			✓
10-46-01	<b>DT800/DT700 Server Information Setup – Register Mode</b> ➡ <i>If the Multiline Telephone application will be using authentication, this program must be set to Automatic.</i> Normal mode: When the phone boots up, it reports the ext. assigned in the phone or chooses the next available extension in the system. No password is required. Auto mode: If set to Auto, the SIP user name and password must be entered in the actual IP phone. These settings must match 84-22/15-05-27, for the phone to come on-line. Manual mode: When the phone boots up it prompts a user to enter a user ID and password before logging in. It checks the user ID/password against 84-22/15-05-27. If there is no match, the phone does not come on-line.	0 = Normal 1 = Auto 2 = Manual	0		✓	

Program Number	Program Name/Description	Input Data	Default	Level		
				1	2	3
10-54-01	<b>License Configuration for Each Package – License Code</b> Assign VoIP Resource Licenses (5103) to GCD-CP10 slot (1).	1 ~ 255 Resource Licenses	No Setting	✓		
15-05-27	<b>IP Telephone Terminal Basic Data Setup – Personal ID Index</b> If the Multiline Telephone application is using manual/auto registration, assign each phone a unique personal index. Then go to command 84-22 to assign the user name and password.	0 ~ 960	0		✓	
15-05-38	<b>IP Telephone Terminal Basic Data Setup – Paging Protocol Mode</b> Sets the protocol mode for the Paging function. ➡ <i>This must be set to Auto or Unicast to receive internal pages.</i>	0 = Multicast 1 = Unicast 2 = Auto	0	✓		
15-05-50	<b>IP Telephone Terminal Basic Data Setup – Peer to Peer Mode</b> On a per station basis enable or disable Peer to Peer mode. This setting must be disabled for remote UT880 VPN Clients.	0 = Disable 1 = Enable	1	✓		
15-20-01	<b>LCD Line Key Name Assignment</b> Define the Line Key Name for line keys on the Multiline Telephone application.	Maximum of eight digits. Maximum of 13 characters. Key Number: 01 ~ 16 (for 16LD TEL) 17 ~ 32 (for 16LD ADM)	LK01 CO001 : : LK08 CO008 LK09 All Blank : : LK48 All Blank		✓	
20-06-01	<b>Class of Service for Extensions</b> Assign Multiline Telephone application handsets to their own Class of Service. ➡ <i>Put UT880 handsets in their own class of service.</i>	Day Night/Mode: 1 ~ 8 Class of Service of Extensions (1 ~ 15)	Extension port 101 = Class 15 All other extension port = Class 1	✓		
24-09-01	<b>Call Forward Split Settings – Call Forwarding Type:</b> Assign Call Forwarding Type and the destination numbers for each extension/virtual extension.	0 = Call Forwarding Off 1 = Call Forwarding with both ring 2 = Call Forwarding when no answer 3 = Call Forwarding all calls 4 = Call Forwarding busy or no answer 5 = Call Forwarding when busy	0		✓	
24-09-02	<b>Call Forward Split Settings – CO Call Forwarding Destination for Both Ring, All Call, No Answer</b> Assign CO Call Forwarding Destination for ring, all call, and no answer.	1 ~ 9, 0, #, *, R, @ Maximum of 24 digits	No Setting		✓	

Program Number	Program Name/Description	Input Data	Default	Level		
				1	2	3
24-09-03	<b>Call Forward Split Settings – Intercom Call Forwarding Destination for Both ring, All Call, No Answer</b> Assign Intercom Call Forwarding Destination for ring, all call and no answer.	1 ~ 9, 0, #, *, R, @ Maximum of 24 digits	No Setting		✓	
24-09-04	<b>Call Forward Split Settings – CO Call Forwarding Busy Destination</b> Assign CO Call Forwarding for busy destinations.	1 ~ 9, 0, #, *, R, @ Maximum of 24 digits	No Setting		✓	
24-09-05	<b>Call Forward Split Settings – Intercom Call Forwarding Busy Destination</b> Assign Intercom Call Forwarding for busy destinations.	1 ~ 9, 0, #, *, R, @ Maximum of 24 digits	No Setting		✓	
24-09-06	<b>Call Forward Split Settings – Call Forwarding Destination for CTX/PBX for All Call, No Answer</b> Assign Call Forwarding for CTX/PBX all call, no answer destinations.	1 ~ 9, 0, #, *, R, @ Maximum of 24 digits	No Setting		✓	
24-09-07	<b>Call Forward Split Settings – Call Forwarding Destination for CTX/PBX for Busy</b> Assign Call Forwarding destinations for busy CTX/PBX calls.	1 ~ 9, 0, #, *, R, @ Maximum of 24 digits	No Setting		✓	
84-22-01	<b>DT800/DT700 Multiline Logon Information Setup – User ID</b> Input the User ID for each Personal ID Index (1-960) when using auto or manual registration in 10-46-01. ➤ <i>IP multiline terminals only support numerical user IDs, not alphanumeric.</i>	Maximum of 32 characters	No Setting		✓	
84-24-28	<b>DT800/DT700 Multiline CODEC Basic Information Setup – Audio Capability Priority</b> Assign the Codec for the NEC DT700 IP Phone. ➤ <i>Set voice (RTP packet) encoding parameters. The UT880 supports G.711 only.</i>	0 = G.711 1 = G.729 2 = G.722 3 = G.726	0			✓
84-26-01	<b>IPL Basic Setup – IP Address</b> Assign the IP address for the DSP on the GPZ-IPLE.	xxx.xxx.xxx.xxx	172.16.0.20	✓		
84-26-02	<b>IPL Basic Setup – RTP Port Number</b> Assign the RTP port number to be used for each DSP on the GPZ-IPLE. ➤ <i>Only even numbered ports are supported.</i>	0 ~ 65534	10020			✓
84-26-03	<b>IPL Basic Setup – RTCP Port Number (RTP Port Number + 1)</b> Define the TCP port number for RTCP to use for each DSP.	0 ~ 65534	10021			✓

Program Number	Program Name/Description	Input Data	Default	Level		
				1	2	3
90-61-01	<p><b>Manual Slot Install – Install</b></p> <p>This can only be set via phone programming. For the slot the SVR2 is installed in set Program 90-61-01 to 3 (Server Blade). This is done so the slot is populated in Web Pro or on a PC Pro download.</p> <p>➡ <i>This program is available only via telephone programming and not through PC Programming.</i></p>	<p>0 = None                      1 = Router                      2 = PVA-NAT                      3 = Server Blade                      4 = PVA-DCU</p>	0	✓		

## Operation

Refer to the InVPN Server Installation Guide for information on configuring the InVPN Server blade.

## IP Multiline Station (SIP)

### Description

The UNIVERGE SV9100 system supports IP extensions using a variety of multiline terminals. These telephones have the same look and functionality of typical multiline telephones, but they are connected to the CCPU via IP rather than by a hardwired connection to a DLC port.

The following DT700 IP multiline telephones (ITL) support IP extensions:

- ITL-2E-1 (BK) TEL
- ITL-6DE-1 (BK) TEL
- ITL-8LDE-1 (BK) TEL
- ITL-8LD-1 (BK) TEL/ITL-8LD-1 (WH) TEL
- ITL-12D-1 (BK) TEL/ITL-12D-1 (WH) TEL
- ITL-12CG-3 (BK) TEL
- ITL-12DG-3 (BK) TEL
- ITL-12PA-1 (BK) TEL
- ITL-24D-1 (BK) TEL/ITL-24D-1 (WH) TEL
- ITL-32D-1 (BK) TEL/ITL-32D-1 (WH) TEL
- ITL-320C-1 (BK) TEL

The following DT800 IP multiline telephones (ITY/ITZ) support IP extensions:

- ITY-6D-1 (BK) TEL
- ITY-8LDX-1 (BK) TEL
- ITZ-8LD-3 (BK) TEL
- ITZ-8LDG-3 (BK) TEL/ITZ-8LDG-3 (WH) TEL
- ITZ-12D-3 (BK) TEL/ITZ-12D-3 (WH) TEL
- ITZ-12CG-3 (BK) TEL/ITZ-12CG-3 (WH) TEL
- ITZ-12DG-3 (BK) TEL/ITZ-12DG-3 (WH) TEL
- ITZ-24D-3 (BK) TEL/ITZ-24D-3 (WH) TEL

## IP to TDM Conversion

When an IP telephone calls a DT300/DT400 multiline telephone, a single line telephone or trunk, the speech must be converted from an IP to TDM (Time Division Multiplexing) technology. The GPZ-IPLE daughter boards provide this function. Each GPZ-IPLE has a number of DSP resources on the blade, each one can convert a speech channel from IP to TDM and vice versa. It is possible for DT700/DT800 IP telephones to talk directly to other DT700/DT800 IP telephones without using GPZ-IPLE DSP resources.

## DT700/DT800 IP Multiline Telephones (ITL)

The IP multiline telephone operates the same way as a DT300/DT400 (DTL/DTZ) digital multiline telephone. The DT700/DT800 has all of the features and flexibility you expect from a DT300/DT400 digital multiline telephone. The difference is that the DT700/DT800 IP telephone uses an RJ-45 for connection to the IP network, rather than an RJ-11 connection to a GCD-8DLCA or GCD-16DLCA.

## Power Save Adapter (PSA-L UNIT)

The Power Save Adapter is an add-on module for the IP (DT700/DT800) and digital (DT300/DT400) multiline telephones. The PSA-L UNIT allows connection to an analog trunk if the power or system connection were to fail, or the IP telephone loses connection to the UNIVERGE SV9100 system. No programming is required on the UNIVERGE SV9100 to support this adapter.

## Connecting to an IP Telephone

The Power Save Adapter connects to an analog PSTN (Public Switched Telephone Network) line. For example, at a small branch office this may be the same line that is used for faxes/modems/etc. The handset is also connected to the Power Save Adapter – You must unplug the handset from the IP telephone and reconnect it to the adapter. This allows the speech path to be redirected to the handset during network power failure.

## LAN Connection

The IP telephone has two RJ-45 connections on the back marked **PC** and **LAN**. This allows the IP telephone and a PC to share one cable run and switch port.

If installing an IP telephone at a location that has a PC connected to the data network, one of the following methods can be used:

- Using a different cable:
  - Leave the PC connected to the LAN.
  - Patch a switch port to the new cable run.
  - Connect a CAT 5 straight-through cable from the wall outlet to the **LAN** port on the IP telephone.
- Sharing the existing cable:
  - Unplug the cable from the PC Network Interface Card (NIC).
  - Connect the cable to the **LAN** port on the IP telephone.
  - Connect a new straight-through patch lead from the PC NIC to the **PC** port on the IP telephone.

## Powering the IP Telephone

Power can be provided to the IP telephone by one of the following methods:

### Local Power

The IP telephone has a connector on the back for external power. This is supplied by an AC adapter that outputs +27VDC requiring a separate power outlet per IP telephone. Loss of power in the building will prevent the telephones from functioning.



### Power over Ethernet (PoE)

The PoE switch (802.3 AF is only method supported) provides power over the spare pairs. The switch can be used with other devices than the IP telephones and detects whether or not power is needed. Using a PoE switch makes it easier to protect the IP telephones from loss of power (connection of the PoE switch to an UPS).

## LLDP

Added support for Link Layer Discover Protocol (LLDP) or IEEE 802.1AB is a vendor neutral Data link layer protocol used by network devices for advertising their identity, capabilities and interconnections on the IEEE 802 LAN network. LLDP performs functions similar to several proprietary protocols such as Cisco Discovery Protocol, Extreme Discovery protocol, Nortel Discovery Protocol (also known as SONMP) and Microsoft's Link Layer Topology Discover (LLTD). If enabled, the IP terminal takes longer to boot as it waits for an information packet. If no LLDP information is received within the RX Wait Time, the terminal continues a normal boot process.

This service supports the Link Layer Discovery Protocol (LLDP) standard and is used to transmit and receive **VLAN information ONLY** about neighboring network devices and IP Telephones. The following are a list of VLAN settings which can be received by the terminal during a LLDP session:

- LAN port Setting/ VLAN ID
- LAN port setting/VLAN Priority
- TOS Mode / RTP
- TOS mode /SIP

## Peer to Peer

An IP telephone can send and receive RTP packets to/from another IP telephone without using the DSP resources on the GPZ-IPLD Daughter Board. This operation only allows intercom calls between the IP telephones.

If a DT700/DT800 IP multiline telephone, or trunk line is required, a DSP resource is needed and a GPZ-IPLD must be installed on the CPU. If, while on a peer to peer call, a conference call is initiated, the peer to peer connection is released and a new non peer to peer connection is created using the GPZ-IPLD. If the third party drops out of the conversation, the call reverts to a peer to peer call (silence may be heard while this conversion is made by the system).



Although the peer to peer feature is supported for IP Station-to-IP Station calls, the UNIVERGE SV9100 chassis must still have a registered GPZ-IPL installed in the system.

With Barge-In, a short silence may be heard if the following occurs:

- A peer to peer call receives a Barge-In without a Barge-In tone.
- A peer to peer call receives a Barge-In with Monitor mode.
- When the established Barge-In is disconnected.
- Peer to peer is a programmable feature that may be enabled or disabled (Program 15-05-50).

### System Tones and Ring Tones

IP telephones do not use Program 80-01: Service Tone Setup entries. The tones are generated locally by the IP telephone. When a Door Box chime rings an IP telephone, the system activates the chimes using a ring command. Because of this, if the volume is adjusted while the door chime is sounding, the ringing volume of the IP telephone is also adjusted.

### Music on Hold

When Program 10-04-01 is set to **Internal**, the SV9100 will not receive Music On Hold from the CPU. IP Terminals music source will come from a locally provided source file (download) based on the setting in Program 10-40-02 (option 1, 2, or 3).

When Program 10-04-01 is set to **External**, the SV9100 uses an outside source for Music On Hold. IP Terminals music source will come from a locally provided external Music On Hold Source.

### Registration Mode

The SV9100 has three types of registration for IP terminals, Plug and Play, Automatic, and Manual programmed in 10-46-01:

- Plug and Play mode – when the phone boots up it reports the extension assigned in the phone or chooses the next available extension in the system. No password is required.
- Automatic mode – the SIP user name and password must be entered in the actual IP phone. The phone comes up as the extension associated with the user name and password is entered.
- Manual mode – when the phone boots up it prompts the user to enter a user ID and password before logging in. If a user ID and password are set in the SIP User settings of the phone, as with Automatic mode, the phone does not prompt for login. This allows some phones to come up automatically and some phones to prompt for login. In manual mode, the phones that do not have a user ID and password set in the phone are prompted to log in. A user can also Logoff the IP phone to allow another user to login with their own user ID and password.

To Logoff the IP phone:

*Press the **Down Arrow Softkey**, press the **Prog Softkey**, and then press the **LOGOFF Softkey**.*

## Multiple Logon

The same user name and password can be assigned to multiple extensions when using Automatic or Manual Registration. This makes it easier on the user by only having to remember one password. For example, if a user has an IP Multiline terminal and uses Desktop Applications with the Enhancement bundle controlling the IP Multiline, three different ports are used in the system.

## Registration Override

When Manual mode is used, Registration Override can be used. Registration Override allows a user to login at one phone, and later login at another phone and keep the same extension number. This is useful in the case where an office user has an IP multiline terminal at work and at home or a Softphone they use on the road. They log in at work to use the office terminal, and when they get home or are on the road they login the home terminal or Softphone. When this happens the office terminal is logged out and they have the same extension number at home or on the road.

Override with CTI is supported on a per station basis using Program 15-05-39 with certain restrictions.

## System IP Phones and Analog Trunks

Due to the nature of analog-to-digital conversion, considerable echo may be encountered when using Analog Trunks with IP Phones.

- ❑ Due to all Analog trunks being different, padding of the Analog Trunks in Programs 81-07 and 14-01 may be necessary. Even after the pad changes are made, an echo may still be present the first few seconds of the call while echo cancellers are learning the characteristics of the circuit on this call. Program 90-68-01 can be used to automatically test the lines and auto assign the proper values in Program 81-07. It is recommended to use this program whenever analog trunks are involved.



NOTE

*Digital (ISDN, T-1, and SIP) trunks do not experience this problem.*



TIP

*For best performance, it is recommended to use digital trunks when using IP phones.*

## Conditions

- Version 2 software for the ITY-6D and ITY-8LDX telephones support the following options:
  - ❑ EHS Headset functionality.
  - ❑ Gigabit Ethernet (requires feature license 5050 for each telephone that will use this feature).
  - ❑ 16 Line Key support on ITY-8LDX (requires feature license 5051 for each telephone that will use this feature).
  - ❑ 32 Line Key support on ITY-8LDX (requires feature license 5052 for each telephone that will use this feature).

- The voice quality of VoIP depends on variables such as available bandwidth, network latency and Quality of Service (QoS) initiatives, all of which are controlled by the network and Internet service providers. Because these variables are not under its control, NEC cannot guarantee the performance of the user's IP-based remote voice solution. Therefore, NEC recommends connecting VoIP equipment through a local area network using a Private IP address.
- IP Multiline Stations must register with the IP address of the GPZ-IPLE. The IP Multiline stations registering via a URL is not supported.
- If an internal paging group has only IP Multiline Stations, multicast is used for the page. IP multiline terminals must have a gateway programmed to accomplish a multicast transmission. When an actual gateway device does not exist on the network, a dummy gateway address on the same subnet must be defined. If the paging group has any TDM stations or an external speaker, multicast is not used and the gateway is not required.
- The system sees terminal types 1 (Economy), 2 (Value), 3 (Desi-Less), 4 (Sophisticated) and 5 (Softphone) as the same terminal type.
- When using Multiple Logon, the same Personal ID index can be assigned to an ITL/Softphone or CTI (Desktop) terminal type.
- Two ports of the same terminal type (Program 15-05-26) cannot be assigned to the same Personal ID index (Program 15-05-27).
- Program 10-46-01 must be set to 1 (Auto) or 2 (Manual) for Multiple Logon to work.
- When three ports are assigned the same Personal ID index in Program 15-05-27, if Program 15-05-26 is not set for those ports, the terminal types will be assigned based on order of login. If Program 15-05-26 is set, the login order does not matter and they will assign the correct port.
- The Override feature functions the same as single login.
- XML Multi-Window Support – the multi-window service adds the following:
  - Multiple XML applications can be displayed and accessed through the NEC terminal XML menu.
  - Line key operation can be performed without closing the active XML application window.
- DT700/DT800 terminals and wireless IP terminals utilizing NAPT can be registered to the primary or a secondary system. Refer to the feature [SV9100 NetLink on page 2-1523](#) for additional details.
- With SV9100 system software and GPZ-IPLE daughter board installed, half duplex connections are not supported. For troubleshooting purposes, a managed switch capable of port mirroring is required to capture packet data from the SV9100 IPLE Ethernet port.
- When downloading firmware for previously installed DT700/DT800 and the ITL-12CG/ITL-12DG/ITZ-12CG/ITZ-12DG terminals, the firmware for both can be downloaded at the same time.

## Restrictions

- Version 1 software for the ITY-6D and ITY-8LDX telephones does NOT support the following options:
  - EHS Headset functionality.
  - Gigabit Ethernet.
  - Multi-page Line Key support using scroll key.
- When using DT700/DT800 IP phones, assigning the following features to a large number of phones (100 or more) is not recommended:
  - The same Trunk Line assignment (squared key system)
  - The same Virtual Extension assignment
  - Paging key with LED ON assignment
  - The same location Park key
  - The same location CAP key
  - The same BLF key assignment
  - Day Night Mode Change key assignment
  - The same VM Mail Box key assignment
  - Trunk Group key
  - Trunk Group All Line Busy Indication
- An SIP multiline terminal can override another SIP multiline terminal or a Softphone.
- A Softphone can override another Softphone or an SIP multiline terminal.
- Override does not support SIP multiline terminal with DSS console or Softphone with DSS Console.
- When using Override with an active CTI connection, Program 15-05-39 must be enabled for the extensions that will be overridden. The overriding terminal must be of the same type and number of line keys as the terminal to be overridden. If the types of terminals and number of keys are different between overriding and overridden phones, the Telephony Service Providers (1st Party and 3rd Party) may not function properly.

## Default Setting

None

## System Availability

### Terminals

All IP Multiline Terminals

## Required Software

None

## Required Component(s)

- GCD-CP10 with GPZ-IPLE Daughter Board installed
- 0411 – SV9100 Version Lic (R1)
- 0300 – SV9100 Resource Lic
- 5103 – SV9100 IP Resource Lic
- 5111 – SV9100 IP Phone Lic
- 5050 – DT820 Gigabit, ITY-6D and ITY-8DLX Gigabit Ethernet
- 5051 – DT820 Ext LK 16, ITY-8LDX 16 Line Key Support
- 5052 – DT820 Ext LK 32, ITY-8LDX 32 Line Key Support

# NAPT Traversal

## Description

NAPT (**N**etwork **A**ddress **P**ort **T**ranslation), is a method by which a private address or addresses and their TCP/UDP ports are translated into a single public address and its TCP/UDP ports. The NAPT feature gives the SV9100 the ability to “traverse” its own subnet. With NAPT, the network administrator can place the GCD-CP10 and the GPZ-IPLE (VoIPDB) in the customers LAN while still making it accessible to users outside the local LAN. The NAPT Feature also allows the IP terminals to be placed in a local LAN in a remote network and be able to communicate back to the SV9100.



Refer to the *SV9100 Networking Manual* for detailed installation instructions on this feature.

The router that the SV9100 resides behind still requires Port Forwarding statements. However the router that the IP terminal/terminals reside behind may not require any port forwarding. This feature is only available when using a GPZ-IPLE. Due to the fact that there are many manufacturers producing routers there may still be times when port forwarding is required.



In all software versions, SIP ALG's (Application Level Gateway) or other SIP Applications **MUST** be disabled in all routers. If a SIP ALG or a similar SIP application is enabled, IP phone service **WILL** be interrupted.

The NAPT feature is only effective when Program15-05-45 is set “1” (On). Refer to [Figure 2-35 Example – NAT Traversal](#) or an examples of the NAT Traversal network. [Table 2-54 Example – Required System Settings on page 2-787](#) and [Table 2-55 Example – Required IP Terminal Settings on page 2-787](#) provide examples of required system and IP terminal settings. Refer to [Table 2-56 Example – SV9100 System Router A Port Forwarding Settings on page 2-787](#) for Port Forwarding setting examples.



Actual input data should be set according to the required system.

Figure 2-35 Example – NAT Traversal

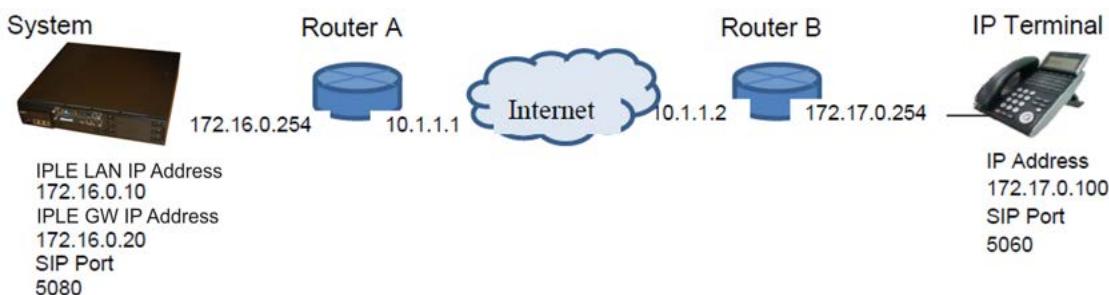

Table 2-54 Example – Required System Settings

Index	Program	Default	Input Data	Remark
1	10-12-03	0.0.0.0	172.16.0.254	LAN IP address of Router A
2	10-12-07	0.0.0.0	10.1.1.1	WAN IP address of Router A
3	10-12-09	172.16.0.10	172.16.0.10	LAN IP address of VOIPDB
4	10-12-10	255.255.0.0	255.255.0.0	Subnet Mask of VOIPDB
5	10-46-14	0:OFF	1:ON	NAT Mode
6	15-05-45	0:OFF	1:ON	NAT RTP send port choice
7	84-26-01	172.16.0.20	172.16.0.20	VOIP DSP IP Address

Table 2-55 Example – Required IP Terminal Settings

Index	Name	Default	Input Data
1	IP Address	0.0.0.0	172.17.0.100
2	Default Gateway	0.0.0.0	172.17.0.254
3	Subnet Mask	0.0.0.0	255.255.0.0
4	NAT Traversal Mode	1: Disable	2: Dynamic
5	WAN Mate IP Address	0.0.0.0	10.1.1.1
6	WAN SIP Mate Port	5060	5080

Table 2-56 Example – SV9100 System Router A Port Forwarding Settings

Port	IP Address Port is Forwarded To	Remarks
5080 (UDP)	172.16.0.10	Signaling port and must be forwarded to the IP Address assigned in Program 10-12-09.
5081 (UDP)	172.16.0.10	Secondary signaling port and must be forwarded to the IP Address assigned in Program 10-12-09.
10020 ~ 10531 (UDP)	172.16.0.20	Voice ports and must be forwarded to the IP Address assigned in Program 84-26-01.

➡ Port forwarding does not need to be assigned at the Remote Terminal location.

## Conditions

- The router the SV9100 resides behind requires Port Forwarding statements.
- When Program 15-05-45 is set to “1” the manual table setting for port forwarding may not be required on the remote side Router B, but the router must support the NAT function setting itself. If Program 15-05-45 is set to “0” port forwarding at the Remote side router is required. This feature requires installation of a GPZ-IPLE.
- The router may close the port being used if packet exchange is not performed during a certain time frame. In this occurs, change Program 15-05-47 and Program 15-05-48 to a shorter interval. These programs are changed on a per station basis. Non NAPT phones will still use Programs 84-23-01 and 84-23-02 while only NAPT phones will use Programs 15-05-47 and 15-05-48.
- The SIP-ALG or similar SIP application function of all routers in the network **must** be disabled.
- The SV9100 Desktop Application does not support Network Address Translation (NAPT). If a user would like to connect the Desktop Application through an Internet Connection the use of a VPN is required.
- If excessive packet loss occurs on the network, IP phones will play a warning tone during conversations. To disable this tone set Program 15-05-31 to “0”.
- Multicast RTP is not supported.
- Peer to Peer is only possible on IP terminals within the same router.
- After starting SIP negotiation for the call, if any RTP packet can't be received from the terminal within 10 seconds, the call is dropped and the IP Terminal displays the following:

```

1-4  FRI  8:53PM
Can' t send RTP packets
List  Dir   ICM  Prog
```

- Each NAPT terminal can have a separate Register and Subscribe expire timer. The load of the CPU will increase with each NAPT terminal using a short timer. Refer to [Table 2-57 NAPT Terminals – Minimum Timer Settings](#) to view the minimum timer settings based on the number of NAPT terminals using Programs 15-05-47 and 15-05-48.

Table 2-57 NAPT Terminals – Minimum Timer Settings

Program Number	Number of DT800/DT700 Terminals Using Programs 15-05-47 and 15-05-48		
	1 ~ 144 (Terminals)	145 ~ 192 (Terminals)	193 ~ 896 (Terminals)
15-05-47 (minimum setting)	60 seconds	90 seconds	180 seconds
15-05-48 (minimum setting)	60 seconds	90 seconds	180 seconds



## Default Settings

None

## System Availability

### Terminals

DT800/DT700

### Required Software

None

### Required Component(s)

- GPZ-IPLE Daughter Board installed
- 0411 – SV9100 Version Lic (R1)
- 5103 – SV9100 IP Resource Lic
- 5111 – SV9100 IP Phone Lic
- 0031 – SV9100 NAT Traversal Lic

## Related Features

None

## Guide to Feature Programming

The **Level 1**, **Level 2** and **Level 3** columns indicate the programs that are assigned when programming this feature in the order they are most commonly used. These levels are used with PCPro and WebPro wizards for feature programming.

- Level 1 – these are the most commonly assigned programs for this feature.
- Level 2 – these are the next most commonly assigned programs for this feature.
- Level 3 – these programs are not often assigned and require an expert level working knowledge of the system to be properly assigned.

**IP Multiline Station (SIP):**

Program Number	Program Name/Description	Input Data	Default	Level		
				1	2	3
10-12-01	<b>GCD-CP10 Network Setup – IP Address</b> Assign the IP Address for the CPU NIC card. When an GPZ-IPLE card is installed in the system, it is recommended to set this Program to <b>0.0.0.0</b> .	0.0.0.0 ~ 126.255.255.254 128.0.0.1 ~ 191.255.255.254 192.0.0.1 ~ 223.255.255.254	192.168.0.10	✓		
10-12-03	<b>GCD-CP10 Network Setup – Default Gateway</b> Assign the default gateway IP address for the GCD-CP10.	0.0.0.0 ~ 126.255.255.254 128.0.0.1 ~ 191.255.255.254 192.0.0.1 ~ 223.255.255.254	0.0.0.0	✓		
10-12-09	<b>GCD-CP10 Network Setup – IP Address</b> Set IP address for GPZ-IPLE. ➡ <i>The IP Address assigned in Program 10-12-01 cannot start with the same leading digits as the IP Address assigned here.</i>	0.0.0.0 ~ 126.255.255.254 128.0.0.1 ~ 191.255.255.254 192.0.0.1 ~ 223.255.255.254	172.16.0.10	✓		
10-12-10	<b>GCD-CP10 Network Setup – Subnet Mask</b> Set the subnet mask of the GPZ-IPLE.	128.0.0.0   192.0.0.0   224.0.0.0  240.0.0.0   248.0.0.0   252.0.0.0  254.0.0.0   255.0.0.0  255.128.0.0   255.192.0.0  255.224.0.0   255.240.0.0  255.248.0.0   255.252.0.0  255.254.0.0   255.255.0.0  255.255.128.0   255.255.192.0  255.255.224.0   255.255.240.0  255.255.248.0   255.255.252.0  255.255.254.0   255.255.255.0  255.255.255.128  255.255.255.192  255.255.255.224  255.255.255.240  255.255.255.248  255.255.255.252  255.255.255.254  255.255.255.255	255.255.0.0	✓		

Program Number	Program Name/Description	Input Data	Default	Level		
				1	2	3
10-46-01	<p><b>DT800/DT700 Server Information Setup – Register Mode</b></p> <p>Normal mode: When the phone boots up, it reports the ext. assigned in the phone or chooses the next available extension in the system. No password is required.</p> <p>Auto mode: If set to Auto, the SIP user name and password must be entered in the actual IP phone. These settings must match 84-22/15-05-27, for the phone to come on-line.</p> <p>Manual mode: When the phone boots up it prompts a user to enter a user ID and password before logging in. It checks the user ID/password against 84-22/15-05-27. If there is no match, the phone does not come on-line.</p>	<p>0 = Normal 1 = Auto 2 = Manual</p>	0		✓	
10-47-01	<p><b>Terminal License Server Information Setup – Register Port of TCP I/F</b></p> <p>Also used by ITY-6D and ITY-8DLX phones to obtain enhancement licenses.</p>	0 ~ 65535	6080		✓	
10-54-01	<p><b>License Configuration for Each Package – License Code</b></p> <p>Assign VoIP Resource licenses (5103) to GCD-CP10 slot (1). If applying more than 255 licenses to a slot, the licenses must be applied across multiple indexes. For example, assigning 256 VoIP resource licenses (5103) to the CPU slot could be assigned using different methods as long as the total for the CPU slot is 256.</p> <p>1. Index 1 has 128 of feature code 5103 and index 2 also has 128 of feature code 5103 for a total of 256. 2. Index 1 has 255 of feature code 5103 and index 2 has 1 of feature code 5103 for a total of 256.</p>	1 ~ 255 Resource Licenses	0	✓		
15-05-15	<p><b>IP Telephone Terminal Basic Data Setup – CODEC Type</b></p> <p>Set the registered IP Phone Codec type – Reference Program 84-24 DT800/DT700 Codec Basic Information.</p>	<p>1-Type 1 2-Type 2 3-Type 3 4-Type 4 5-Type 5</p>	1	✓		

Program Number	Program Name/Description	Input Data	Default	Level		
				1	2	3
15-05-26	<b>IP Telephone Terminal Basic Data Setup – DT800/DT700 Terminal Type</b> Set the DT800/DT700 series terminal type.	0 = Not Set 1 = ITL-( )E-1D/IP-( )E-1 2 = ITL-( )D-1D/ITL-12BT-1D/ITL-12PA-1D [without 8LKI(LCD)-L] 3 = ITL-( )D-1D/ITL-12BT-1D/ITL-12PA-1D [with 8LKI(LCD)-L] 4 = ITL-320C-1 5 = Softphone 6 = CTI 7 = AGW 10 = ITL-12DG-3 11 = ITL-12CG-3 12 = ITL-0-1 13 = ITZ-**-*D/ITZ-**PD-*D/ITZ-**pA-*D 14 = ITZ-*CG 15 = ITZ-*DE 16 = ITZ-*LDE	0			✓
15-05-39	<b>IP Telephone Terminal Basic Data Setup – CTI Override Mode</b> Enable/Disable the ability of a station to be overridden when CTI is active.	0 = Disable 1 = Enable	0		✓	
15-05-50	<b>IP Telephone Terminal Basic Data Setup – Peer to Peer Mode</b> On a per station basis enable or disable Peer to Peer mode.	0 = Disable 1 = Enable	1	✓		
84-10-01	<b>ToS Setup – ToS Mode</b> When Input Data is set to 1, Protocol 7 is invalid. When Data is set to 2, Protocols 2 ~ 6 are invalid.	0 = Disable (Invalid) 1 = IP Precedence 2 = Diffserv	0		✓	
84-10-07	<b>ToS Setup – Priority (D.S.C.P. - Differentiated Services Code Point)</b> DSCP (Differentiated Services Code Point).	0 ~ 63	0		✓	
84-22-01	<b>DT800/DT700 Multiline Logon Information Setup – User ID</b> Input the User ID for each Personal ID Index (1-960) when using auto or manual registration in 10-46-01. ➡ <i>IP multiline terminals only support numerical user IDs, not alphanumeric.</i>	Maximum of 32 characters	No Setting		✓	
84-22-02	<b>DT800/DT700 Multiline Logon Information Setup – Password</b> Input the Password for each Personal ID Index (1-960) when using manual or auto registration in Program 10-46-01.	Maximum of 16 characters	No Setting		✓	

Program Number	Program Name/Description	Input Data	Default	Level		
				1	2	3
84-22-03	<p><b>DT800/DT700 Multiline Logon Information Setup – User ID Omission</b></p> <p>Enable/Disable User ID Omission.</p> <p>➔ <i>Used when the registration mode (10-46-01) is set to manual. When the phone prompts for a login, the previous user ID appears so the user only has to enter the password.</i></p>	<p>0 = Off</p> <p>1 = On</p>	0		✓	
84-22-04	<p><b>DT800/DT700 Multiline Logon Information Setup – Log Off</b></p> <p>When the registration mode (10-46-01) is set to manual, and the phone prompts for a login, the previous user ID appears so the user only has to enter the password.</p> <p>When enabled, the extension assigned to the Personal ID Index can be logged off or overridden by another IP multiline station or Softphone.</p> <p>➔ <i>In Manual mode a user can also Logoff the IP phone to allow another user to login with their own user ID and password.</i></p> <p><i>To Logoff the IP phone:</i>            Press the <b>Down Arrow</b> Softkey, press the <b>Prog</b> Softkey, and then press the <b>LOGOFF</b> Softkey.</p>	<p>0 = Off</p> <p>1 = On</p>	1		✓	
84-22-05	<p><b>DT800/DT700 Multiline Logon Information Setup – Nick Name</b></p> <p>Input the Personal ID from terminal automatically when log on again.</p>	Maximum of 32 characters	No Setting		✓	
84-24-28	<p><b>DT800/DT700 Multiline CODEC Basic Information Setup – Audio Capability Priority</b></p> <p>Assign the Codec for the NEC DT700 IP Phone.</p>	<p>0 = G.711</p> <p>1 = G.729</p> <p>2 = G.722</p>	0		✓	
84-26-01	<p><b>IPL Basic Setup – IP Address</b></p> <p>Assign the IP address for the DSP on the GPZ-IPLE.</p>	xxx.xxx.xxx.xxx	172.16.0.20	✓		
84-26-02	<p><b>IPL Basic Setup – RTP Port Number</b></p> <p>Assign the RTP port number to be used for each DSP on the GPZ-IPLE.</p> <p>➔ <i>Only even numbered ports are supported.</i></p>	0 ~ 65534	10020	✓		

**IP Multiline Station (SIP) with NAPT:**

Program Number	Program Name/Description	Input Data	Default	Level		
				1	2	3
10-12-01	<b>GCD-CP10 Network Setup – IP Address</b> Assign the IP Address for the CPU NIC card. When an GPZ-IPLE card is installed in the system, it is recommended to set this Program to <b>0.0.0.0</b> .	0.0.0.0 ~ 126.255.255.254 128.0.0.1 ~ 191.255.255.254 192.0.0.1 ~ 223.255.255.254	192.168.0.10	✓		
10-12-03	<b>GCD-CP10 Network Setup – Default Gateway</b> Assign the default gateway IP address for the GCD-CP10.	0.0.0.0 ~ 126.255.255.254 128.0.0.1 ~ 191.255.255.254 192.0.0.1 ~ 223.255.255.254	0.0.0.0	✓		
10-12-07	<b>GCD-CP10 Network Setup – NAPT Router IP Address (Default Gateway [WAN])</b> Assign the WAN address of the router that the CCPU is using for NAT.	0.0.0.0 ~ 126.255.255.254 128.0.0.1 ~ 191.255.255.254 192.0.0.1 ~ 223.255.255.254	0.0.0.0	✓		
10-12-09	<b>GCD-CP10 Network Setup – IP Address</b> Set IP address for GPZ-IPLE. ➡ <i>The IP Address assigned in Program 10-12-01 cannot start with the same leading digits as the IP Address assigned here.</i>	0.0.0.0 ~ 126.255.255.254 128.0.0.1 ~ 191.255.255.254 192.0.0.1 ~ 223.255.255.254	172.16.0.10	✓		
10-12-10	<b>GCD-CP10 Network Setup – Subnet Mask</b> Set the subnet mask of the GPZ-IPLE.	128.0.0.0   192.0.0.0   224.0.0.0  240.0.0.0   248.0.0.0   252.0.0.0  254.0.0.0   255.0.0.0  255.128.0.0   255.192.0.0  255.224.0.0   255.240.0.0  255.248.0.0   255.252.0.0  255.254.0.0   255.255.0.0  255.255.128.0   255.255.192.0  255.255.224.0   255.255.240.0  255.255.248.0   255.255.252.0  255.255.254.0   255.255.255.0  255.255.255.128  255.255.255.192  255.255.255.224  255.255.255.240  255.255.255.248  255.255.255.252  255.255.255.254  255.255.255.255	255.255.0.0	✓		
10-46-06	<b>DT800/DT700 Server Information Setup – Register Mode</b> Assign the port number in which the SIP messages are sent on the GPZ-IPLE. This same port number must be assigned in the SIP multiline terminals. If this command is changed, it requires a CPU <b>reset</b> .	0 ~ 65535	5080		✓	
10-46-13	<b>DT800/DT700 Server Information Setup – Subscribe Session Port</b> Assign the port number to be used for subscription messages between the SV9100 and the DT700 terminals.	0 ~ 65535	5081		✓	

Program Number	Program Name/Description	Input Data	Default	Level		
				1	2	3
10-46-14	<b>DT800/DT700 Server Information Setup – NAT Mode</b> Turns On/Off the DT700 NAT mode of the system.	0 = Off 1 = On	50	✓		
10-58-01	<b>Network Address – Network Address</b> This program sets the IP or Network address for phones that are not to be routed through the NAPT translations. For example, if a system had multiple NAPT phones and another site, with multiple IP phones connected via a VPN connection, you would not want the phones connected over the VPN to use the NAPT feature. The network address (or single IP phone addresses) of the Remote location would be entered here. This is for the IP Phones at this location to not use the NAPT feature.	0.0.0.0 ~ 126.255.255.254 128.0.0.1 ~ 191.254.255.254 192.0.0.1 ~ 223.255.255.254	0.0.0.0		✓	
10-58-02	<b>Network Address – Subnet Mask</b> This program sets the netmask for the IP Addresses assigned in Program 10-58-01.	128.0.0.0   192.0.0.0   224.0.0.0  240.0.0.0   248.0.0.0   252.0.0.0  254.0.0.0   255.0.0.0  255.128.0.0   255.192.0.0  255.224.0.0   255.240.0.0  255.248.0.0   255.252.0.0  255.254.0.0   255.255.0.0  255.255.128.0   255.255.192.0  255.255.224.0   255.255.240.0  255.255.248.0   255.255.252.0  255.255.254.0   255.255.255.0  255.255.255.128  255.255.255.192  255.255.255.224  255.255.255.240  255.255.255.248  255.255.255.252  255.255.255.254  255.255.255.255	255.255.0.0		✓	
15-05-45	<b>IP Telephone Terminal Basic Data Setup – NAT Plug and Play</b> This program is valid when Program 10-46-14 is On (NAT feature activated). Select sending RTP port number to remote Router, use from negotiation result (0) or received RTP packet (1). SV9100 uses this program to decide a destination port of RTP transmitting packets from IPLE to a remote IP terminal. If "0:OFF" is selected, the destination port of RTP transmitting packets will be a SIP/SDP negotiation result.(same behavior as before). If you chose "1:ON", the destination port of RTP transmitting packet will be the same port of a source port of a receiving RTP packet on IPLE.	0 = Disable 1 = Enable	0	✓		

Program Number	Program Name/Description	Input Data	Default	Level		
				1	2	3
15-05-47	<b>IP Telephone Terminal Basic Data Setup – Registration Expire Timer for NAT</b> On a per station basis, this setting defines the SIP registration expiry timer. If this value is set to 0, for a NAPT terminal, the value in Program 84-23-01 is applied.	60 ~ 65535 seconds 0 = Disable	180		✓	
15-05-48	<b>IP Telephone Terminal Basic Data Setup – Subscribe Expire Timer for NAT</b> On a per station basis, this setting defines the SIP Subscribe expiry timer. If this value is set to 0, for a NAPT terminal, the value in Program 84-23-02 is applied.	60 ~ 65535 seconds 0 = Disable	180		✓	
84-26-01	<b>IPL Basic Setup – IP Address</b> Assign the IP address for the DSP on the GPZ-IPLE.	xxx.xxx.xxx.xxx	172.16.0.20	✓		
84-26-02	<b>IPL Basic Setup – RTP Port Number</b> Assign the RTP port number to be used for each DSP on the GPZ-IPLE. ➡ Only even numbered ports are supported.	0 ~ 65534	10020		✓	
84-26-03	<b>IPL Basic Setup – RTCP Port Number (RTP Port Number + 1)</b> Define the TCP port number for RTCP to use for each DSP.	0 ~ 65534	10021		✓	

In addition to the above programming, define the programming options as required for the system features.



Refer to the *UNIVERGE SV9100 Programming Manual* and the *UNIVERGE SV9100 Networking Manual* for programming details.

### Operation



Refer to the *UNIVERGE SV9100 Networking Manual* for detailed feature information.



## *IP Multiline Station (SIP) – MLC Mobile*

### Description

The Multiline Client (MLC) is a multiline SIP application installed on iOS™ or Android™ devices that emulate a NEC VoIP desk phone for use on the SV9100 system. This device can be a mobile phone or tablet/iPad® allowing users to “bring their own device”. The client will work while the device is in the Wi-Fi network local to the SV9100. With a user provided VPN connection it will also work over a mobile data network.

### Installing the MLC Client:

The Multiline Client Application is installed from the appropriate store for the device (Google Play™ or iTunes®). You must have an account with the appropriate store to install this application. If the application is already installed it can be accessed using the Multiline Client icon on the APPS page. Refer to the Multiline Client (MLC) User Guide for detailed setup and operation information. The Google Play store will indicate if a particular device is supported.

1. Go to the appropriate device store (Google Play or iTunes).
2. Search for **NEC Multiline Client**.
3. Choose to install the NEC Multiline Client and follow the corresponding instructions.
4. Open the application using the Multiline Client icon.

### Updating the MLC Client:

MLC Client updates are completed using the appropriate store for the device.

### Conditions

- To be able to use the same extension number on multiple MLC Client devices, the SV9100 must be set to use Registration Override with Program 10-46-01, 15-05-27 and 84-22-xx.
- The Wi-Fi network used by MLC client devices must support VoIP QoS.
- The MLC client must reside in a Wi-Fi network local to the SV9100 system or be on a VPN connection to the local network.
- The MLC client is not supported over NAT.
- UC Suite on the MLC Client follows the UC Web Client feature set.
- Refer to UC Suite documentation to confirm the UC Suite server software is compatible with Multiline Client.
- Refer to the Google Play store to confirm your Android device supports the Multiline Client.
- When used on Android devices from different manufacturers the Multiline Client can have slightly different behavior and voice quality.

- The MLC does not support roaming between Wi-Fi and mobile data networks.
- The MLC client supports Bluetooth headsets, see feature table for OS specific conditions.
- The MLC client uses iSIP integration to SV9100.
- The MLC client system supports G.711 and G.729 CODECs only.
- The MLC client will follow the ring no answer forward timer whenever the MLC is turned off or is not registered with the system except when Call Forward with Follow Me is set.
- The SV9100 requires one VoIP Resource License (5103), one IP Terminal license (5111) and one Resource License (0300) per MLC client telephone.
- The MLC client telephone cannot be used on multiple SIP servers at the same time.
- Each MLC Mobile Client requires one SV9100 MLC USER-1 LIC.
- The MLC client requires Android version 4.4 or higher.
- The MLC client requires iOS version 9.2 or higher.
- The MLC client does not support video calls.
- The MLC client supports Peer-to-Peer in a standalone system only.
- When used in a K-CCISoIP network, Peer-to-Peer (Program 15-05-50) must be disabled for MLC extensions if calls are to be made to remote systems.
- The MLC client cannot have a wired headset and Bluetooth headset connected at the same time.

Table 2-58 Supported System Feature List

Feature	Supported	Comment
Abbreviated Dialing/Speed Dial	Yes	Speed dial locations can only be accessed using soft keys for outbound calls but can be stored using dial access codes.
Account Code Entry	Yes	
Account Code - Forced/Verified/Unverified	Yes	
Alarm	Yes	
Alarm Reports	N/A	
Alphanumeric Display	Yes	
Analog Communications Interface (ACI)	N/A	
Ancillary Device Connection	No	
Answer Hold	Yes	
Answer Key	Yes	
Applications	No	
Attendant Call Queuing	Yes	

Table 2-58 Supported System Feature List (Continued)

Feature	Supported	Comment
Automatic Release	N/A	
Automatic Route Selection (ARS)	Yes	
Background Music	No	
Barge-In	Yes	
Call Appearance (CAP) Keys	Yes	
Call Arrival (CAR) Keys	Yes	
Call Duration Timer	Yes	
Call Forwarding	Yes	
Call Forwarding with Follow Me	Yes	MLC client must be connected to the system.
Call Forwarding – Centrex	Yes	
Call Forwarding – Park and Page	Yes	
Call Forwarding, All, BNA, Busy and Both Ring	Yes	
Call Forwarding, Off-Premise	Yes	
Call Forwarding/Do Not Disturb Override	Yes	
Call Monitoring	Yes	
Call Redirect	Yes	Only ringing calls can be redirected.
Call Transfer	Yes	
Callback	Yes	
Caller ID Caller Return	Yes	
Caller ID	Yes	
Call Waiting/Camp-On	Yes	
Central Office Calls, Answering	Yes	
Central Office Calls, Placing	Yes	
Class of Service	Yes	
Clock/Calendar Display	Yes	
Code Restriction	Yes	
Code Restriction Override	Yes	
Code Restriction, Dial Block	Yes	
Conference Calls	Yes	
Conference, Voice Call/Privacy Release	Yes	
Contact Center	Yes	
Cordless Telephone Connection	No	
CO Message Waiting Indication	No	

Table 2-58 Supported System Feature List (Continued)

Feature	Supported	Comment
Data Line Security	Yes	
Delayed Ringing	Yes	
Department Calling	Yes	
Department Step Calling	Yes	To receive a Department Step Call the MLC client cannot have any forwarding enabled.
Dialing Number Preview	Yes	
Dial Pad Confirmation Tone	No	
Dial Tone Detection	Yes	
Directed Call Pickup	Yes	
Directory Dialing	Yes	Cursor key operations and TELBK are not supported.
Direct Inward Dialing (DID)	Yes	
Direct Inward Line (DIL)	Yes	
Direct Inward System Access (DISA)	N/A	
Direct Station Selection (DSS) Console	Yes	
Distinctive Ringing, Tones and Flash Patterns	No	This is a function of the MLC client, not the phone system.
Door Box	Yes	A Door Box will ring a MLC client and a MLC client can call a door box but it cannot activate the relay.
Do Not Disturb	Yes	
Drop Key	Yes	
E911/911	Yes	
Flash	Yes	
Flexible System Numbering	Yes	
Flexible Timeouts	Yes	
Forced Trunk Disconnect	Yes	
Group Call Pickup	Yes	
Group Listen	No	
Hands Free	Yes	
Handset Mute	Yes	

Table 2-58 Supported System Feature List (Continued)

Feature	Supported	Comment
Headset Operation	Yes	The MLC client cannot have a wired headset and Bluetooth headset connected at the same time.  For Bluetooth headsets the following conditions apply when using the Mic key to mute the headset. iOS: To have mic key functionality either use the “Mute” icon on screen 1 or a Mic key (751: 02) must be programmed on an available line key. The MLC Dialer Mic key has no affect on this function. Android: To have mic key functionality either use either the “Mute” icon on screen 1 or the MLC Dialer Mic key.
Hold	Yes	
Hotel/Motel	Yes	
Hotline	Yes	
Howler Tone Service	Yes	
InMail	Yes	
Interactive Voice Response	N/A	
Intercom	Yes	
IP Multiline Station (SIP)	Yes	
IP Trunk – H.323	Yes	
IP Trunk – (SIP) Session Initiation Protocol	Yes	
ISDN Compatibility	Yes	
K-CCIS – IP	Yes	If MLC client phones are required to call across K-CCISoIP networks, peer-to-peer must be disabled in Program 15-05-50 for the MLC client extensions.
K-CCIS – T1	Yes	
Last Number Redial	Yes	
Licensing	Yes	
Line Load Control	Yes	
Line Preference	Yes	
Long Conversation Cutoff	Yes	
Meet Me Conference	Yes	Can join a Meet Me Conference but does not receive internal pages to join an internal Meet Me Conference.
Meet Me Paging	Yes	Can initiate a Meet Me Page but does not receive internal pages to join an internal Meet Me Page.
Meet Me Paging Transfer	Yes	Can initiate a Meet Me Page but does not receive internal pages to join an internal Meet Me Page.
Memo Dial	Yes	
Message Waiting Indication (MWI)	Yes	

Table 2-58 Supported System Feature List (Continued)

Feature	Supported	Comment
Microphone Cutoff	Yes	iOS: Control of Bluetooth headset microphone is via “Mute” icon on screen one. It cannot be controlled via the MLC “Mic” icon. Android: Control of Bluetooth headset microphone is via MLC “Mic” icon or “Mute” icon on screen one.
Multiple Trunk Types	Yes	
Music on Hold	Yes	System MOH only.
Name Storing	Yes	
Night Service	Yes	
Off-Hook Signaling	Yes	
Off-Premise Extension	No	
One-Touch Calling	Yes	
Operator	Yes	
Paging, External	Yes	A MLC client can only initiate an Internal, External or All Call Page. It cannot receive either Internal or All Call pages.
Paging, Internal	Yes	A MLC client can only initiate an Internal, External or All Call Page. It cannot receive either Internal or All Call pages.
Park	Yes	
PBX Compatibility	Yes	
PC Programming	N/A	
Personal Park	Yes	
Power Failure Transfer	No	
Prime Line Selection	Yes	
Private Line	Yes	
Programmable Function Keys	Yes	
Programming from a Multiline Terminal	No	
Pulse to Tone Conversion	No	
Quick Transfer to Voice Mail	Yes	
Repeat Redial	Yes	
Reverse Voice Over	Yes	
Ringdown Extension, Internal/External	Yes	
RGA Conference	Yes	
Ring Groups	Yes	
Room Monitor	No	
Save Number Dialed	Yes	
Secondary Incoming Extension	Yes	

Table 2-58 Supported System Feature List (Continued)

Feature	Supported	Comment
Secretary Call Pickup	Yes	
Secretary Call (Buzzer)	Yes	
Selectable Display Messaging	Yes	
Selectable Ring Tones	No	
Serial Call	Yes	
Simple MCU Video	No	
Single Line Telephones, Analog 500/2500 Sets	N/A	
SLT Adapter	No	
Softkeys	Yes	
Speed Dial – System/Group/Station	Yes	Speed dial locations can only be accessed using soft keys for outbound calls but can be stored using dial access codes.
Speed Dial – Telephone Book	Yes	
Station Hunt	Yes	
Station Message Detail Recording	Yes	
Station Name Assignment – User Programmable	Yes	
Station Relocation	Yes	
Synchronous Ringing	No	
T1 Trunking (with ANI/DNIS Compatibility)	Yes	
Tandem Ringing	No	
Tandem Trunking (Unsupervised Conference)	Yes	
TAPI Compatibility	Yes	
Tone Override	Yes	
Transfer	Yes	
Trunk Groups	Yes	
Trunk Group Routing	Yes	
Trunk Queuing/Camp-On	Yes	
UC Suite	Yes	
UM8000	Yes	
Uniform Call Distribution (UCD)	Yes	
Uniform Numbering Network	Yes	
User Programming Ability	Yes	
Video Call	No	
Virtual Extensions	Yes	

Table 2-58 Supported System Feature List (Continued)

Feature	Supported	Comment
Voice Mail Integration (Analog)	Yes	
Voice Over	No	
Voice Over Internet Protocol (VoIP)	Yes	
Voice Response System (VRS) – Call Forwarding – Park and Page	Yes	
Volume Controls	Yes	iOS: Volume control is via the device volume keys not the MLC application “up” and “down” icons. Android: Volume control is via the MLC application “up” and “down” icons and the device volume keys.

### Default Settings

None

### System Availability

#### Terminals

N/A

#### Required Component(s)

- GCD-CP10 with GPZ-IPLE Daughter Board installed
- 0411 – SV9100 Version Lic (R1)
- 0300 – SV9100 Resource Lic
- 5103 – SV9100 IP Resource Lic
- 5111 – SV9100 IP Phone Lic
- SV9100 MLC USER-1 LIC, one for each MLC Mobile Client

### Related Features

- ➔ [Call Forwarding](#)
- ➔ [Intercom](#)
- ➔ [IP Multiline Station \(SIP\)](#)



## Guide to Feature Programming

The **Level 1**, **Level 2** and **Level 3** columns indicate the programs that are assigned when programming this feature in the order they are most commonly used. These levels are used with PCPro and WebPro wizards for feature programming.

- ❑ Level 1 – these are the most commonly assigned programs for this feature.
- ❑ Level 2 – these are the next most commonly assigned programs for this feature.
- ❑ Level 3 – these programs are not often assigned and require an expert level working knowledge of the system to be properly assigned.

Program Number	Program Name/Description	Input Data	Default	Level		
				1	2	3
10-12-01	<b>GCD-CP10 Network Setup – IP Address</b> Assign the IP Address.	0.0.0.0 ~ 126.255.255.254 128.0.0.1 ~ 191.255.255.254 192.0.0.1 ~ 223.255.255.254	192.168.0.10	✓		
10-12-03	<b>GCD-CP10 Network Setup – Default Gateway</b> Assign the default gateway IP address for the GCD-CP10.	0.0.0.0 ~ 126.255.255.254 128.0.0.1 ~ 191.255.255.254 192.0.0.1 ~ 223.255.255.254	0.0.0.0	✓		
10-12-09	<b>GCD-CP10 Network Setup – IP Address</b> Set IP address for GPZ-IPLE. ➡ <i>The IP Address assigned in Program 10-12-01 cannot start with the same leading digits as the IP Address assigned here.</i>	0.0.0.0 ~ 126.255.255.254 128.0.0.1 ~ 191.255.255.254 192.0.0.1 ~ 223.255.255.254	172.16.0.10	✓		
10-13-01	<b>DHCP Server Mode</b> Enable/Disable the built-in DHCP Server.	0 = Disable 1 = Enable	0			✓
10-13-02	<b>Lease Time</b> Lease time of the IP address to a client. Press the Transfer Key to increment to the next setting data.	Days 0 ~ 255 Hour 0 ~ 23	0 day 0 hour			✓
10-13-05	<b>Last DHCP Data</b> If 10-13-01 is enabled, this setting determines if DHCP resource is enabled or disabled.	0 = Disable 1 = Enable	1			✓
10-19-01	<b>VoIP DSP Resource Selection</b> Select type of GPZ-IPLE DSP Resource. This program setting has no affect on the terminal/trunk port assignment or usage.	0 = Common use for both IP extensions and trunks 1 = IP Extension 2 = SIP Trunk 3 = CCIS/Networking 4 = Use for NetLink 5 = Blocked 6 = Common without Unicast Paging 7 = Multicast Paging 8 = Unicast Paging	Resource 1 = 1 Resource 2-256 = 0			✓

Program Number	Program Name/Description	Input Data	Default	Level		
				1	2	3
10-46-01	<p><b>DT800/DT700 Server Information Setup – Register Mode</b></p> <p>➔ <i>If the MLC client will be using authentication, this program must be set to Automatic.</i></p> <p>Normal mode: When the phone boots up, it reports the ext. assigned in the phone or chooses the next available extension in the system. No password is required.</p> <p>Auto mode: If set to Auto, the SIP user name and password must be entered in the actual IP phone. These settings must match 84-22/15-05-27, for the phone to come on-line.</p> <p>Manual mode: When the phone boots up it prompts a user to enter a user ID and password before logging in. It checks the user ID/password against 84-22/15-05-27. If there is no match, the phone does not come on-line.</p>	<p>0 = Normal 1 = Auto 2 = Manual</p>	0		✓	
10-54-01	<p><b>License Configuration for Each Package – License Code</b></p> <p>Assign VoIP Resource Licenses (5103) to GCD-CP10 slot (1).</p> <p>If applying more than 255 licenses to a slot, the licenses must be applied across multiple indexes.</p> <p>For example, assigning 256 VoIP resource licenses (5103) to the CPU slot could be assigned using different methods as long as the total for the CPU slot is 256.</p> <p>1. Index 1 has 128 of feature code 5103 and index 2 also has 128 of feature code 5103 for a total of 256.</p> <p>2. Index 1 has 255 of feature code 5103 and index 2 has 1 of feature code 5103 for a total of 256.</p>	1 ~ 255 Resource Licenses	No Setting	✓		
15-05-27	<p><b>IP Telephone Terminal Basic Data Setup – Personal ID Index</b></p> <p>If the MLC client is using manual/auto registration, assign each phone a unique personal index. Then go to command 84-22 to assign the user name and password.</p>	0 ~ 960	0		✓	
15-05-50	<p><b>IP Telephone Terminal Basic Data Setup – Peer to Peer Mode</b></p> <p>On a per station basis enable or disable Peer to Peer mode.</p>	<p>0 = Disable 1 = Enable</p>	1		✓	

Program Number	Program Name/Description	Input Data	Default	Level		
				1	2	3
15-20-01	<b>LCD Line Key Name Assignment</b> Define the Line Key Name for line keys on the MLC client.	Maximum of eight digits. Maximum of 13 characters. Key Number: 01 ~ 16 (for 16LD TEL) 17 ~ 32 (for 16LD ADM)	LK01 CO001 : : LK08 CO008 LK09 All Blank : : LK48 All Blank		✓	
20-06-01	<b>Class of Service for Extensions</b> Assign MLC clients to their own Class of Service.	Day Night/Mode: 1 ~ 8 Class of Service of Extensions (1 ~ 15)	Extension port 101 = Class 15 All other extension port = Class 1	✓		
24-09-01	<b>Call Forward Split Settings – Call Forwarding Type:</b> Assign Call Forwarding Type and the destination numbers for each extension.	0 = Call Forwarding Off 1 = Call Forwarding with both ring 2 = Call Forwarding when no answer 3 = Call Forwarding all calls 4 = Call Forwarding busy or no answer 5 = Call Forwarding when busy	0		✓	
24-09-02	<b>Call Forward Split Settings – CO Call Forwarding Destination for Both Ring, All Call, No Answer</b> Assign CO Call Forwarding Destination for ring, all call and no answer.	1 ~ 9, 0, #, *, R, @ Maximum of 24 digits	No Setting		✓	
24-09-03	<b>Call Forward Split Settings – Intercom Call Forwarding Destination for Both ring, All Call, No Answer</b> Assign Intercom Call Forwarding Destination for ring, all call and no answer.	1 ~ 9, 0, #, *, R, @ Maximum of 24 digits	No Setting		✓	
24-09-04	<b>Call Forward Split Settings – CO Call Forwarding Busy Destination</b> Assign CO Call Forwarding for busy destinations.	1 ~ 9, 0, #, *, R, @ Maximum of 24 digits	No Setting		✓	
24-09-05	<b>Call Forward Split Settings – Intercom Call Forwarding Busy Destination</b> Assign Intercom Call Forwarding for busy destinations.	1 ~ 9, 0, #, *, R, @ Maximum of 24 digits	No Setting		✓	
24-09-06	<b>Call Forward Split Settings – Call Forwarding Destination for CTX/PBX for All Call, No Answer</b> Assign Call Forwarding for CTX/PBX all call, no answer destinations.	1 ~ 9, 0, #, *, R, @ Maximum of 24 digits	No Setting		✓	
24-09-07	<b>Call Forward Split Settings – Call Forwarding Destination for CTX/PBX for Busy</b> Assign Call Forwarding destinations for busy CTX/PBX calls.	1 ~ 9, 0, #, *, R, @ Maximum of 24 digits	No Setting		✓	

Program Number	Program Name/Description	Input Data	Default	Level		
				1	2	3
84-22-01	<p><b>DT800/DT700 Multiline Logon Information Setup – User ID</b></p> <p>Input the User ID for each Personal ID Index (1-960) when using auto or manual registration in 10-46-01.</p> <p>➤ <i>IP multiline terminals only support numerical user IDs, not alphanumeric.</i></p>	Maximum of 32 characters	No Setting		✓	
84-22-02	<p><b>DT800/DT700 Multiline Logon Information Setup – Password</b></p> <p>Input the Password for each Personal ID Index (1-960) when using manual or auto registration in Program 10-46-01.</p>	Maximum of 16 characters	No Setting		✓	
84-22-03	<p><b>DT800/DT700 Multiline Logon Information Setup – User ID Omission</b></p> <p>Enable/Disable User ID Omission.</p> <p>➤ <i>Used when the registration mode (10-46-01) is set to manual. When the phone prompts for a login, the previous user ID appears so the user only has to enter the password.</i></p>	0 = Off 1 = On	0		✓	
84-22-04	<p><b>DT800/DT700 Multiline Logon Information Setup – Log Off</b></p> <p>When the registration mode (10-46-01) is set to manual, and the phone prompts for a login, the previous user ID appears so the user only has to enter the password.</p> <p>When enabled, the extension assigned to the Personal ID Index can be logged off or overridden by another IP multiline station or Softphone.</p> <p>➤ <i>In Manual mode a user can also Logoff the IP phone to allow another user to login with their own user ID and password.</i></p> <p><i>To Logoff the IP phone: Press the <b>Down Arrow</b> Softkey, press the <b>Prog</b> Softkey, and then press the <b>LOGOFF</b> Softkey.</i></p>	0 = Off 1 = On	1		✓	
84-22-05	<p><b>DT800/DT700 Multiline Logon Information Setup – Nick Name</b></p> <p>Input the Personal ID from terminal automatically when log on again.</p>	Maximum of 32 characters	No Setting		✓	
84-24-28	<p><b>DT800/DT700 CODEC Information Basic Setup – Audio Capability Priority</b></p> <p>Set voice (RTP packet) encoding parameters. The MLC supports G.711 only.</p>	0 = G.711_PT 1 = G.729_PT 2 = G.722 3 = G.726	0			✓
84-26-01	<p><b>IPL Basic Setup – IP Address</b></p> <p>Assign the IP address for the DSP on the GPZ-IPLE.</p>	xxx.xxx.xxx.xxx	172.16.0.20	✓		

Program Number	Program Name/Description	Input Data	Default	Level		
				1	2	3
84-26-02	<b>IPL Basic Setup – RTP Port Number</b> Assign the RTP port number to be used for each DSP on the GPZ-IPLE. ➔ <i>Only even numbered ports are supported.</i>	0 ~ 65534	10020			✓
84-26-03	<b>IPL Basic Setup – RTCP Port Number (RTP Port Number + 1)</b> Define the TCP port number for RTCP to use for the GPZ-IPLE.	0 ~ 65534	10021			✓

## Operation



REFERENCE

Refer to the *Multiline Client (MLC) User Guide* for detailed setup and operation information.

## IP Multiline Station (SIP) – ML440 Cordless

### Description

Many SMB businesses, understanding the impact of a mobile workforce, are rapidly defining their requirements for enabling effective communications and information access for mobile users. SMB Mobility will allow the individual staff member to be instantly accessible- thus becoming more productive.

The ML440 IP Wireless Handset is an ergonomically designed compact wireless handset for business users who are mobile in the office and want to make and receive wireless calls while in the office. The DECT protocol operates in the 1.9 GHz frequency band that has been cleared specifically for voice applications, thus avoiding any interference problems and delivering crystal clear and secure voice conversations.

The ML440 provides numerous features and conveniences for optimal comfort. Its illuminated graphic color LCD display enables use in poorly lit environments, while its internal loudspeaker provides Handsfree operation with excellent sound quality. Powerful encryption techniques ensure secure communication, and it can also provide the subscriber with most of the features available for a wired phone, in addition to its roaming and handover capabilities.

Unlike other in-building wireless solutions for the SV9100, the ML440 is an integrated multiline handset capable of supporting the key elements of a SMB mobile solution. A complete list of supported features can be found below.

### Basic Operation

Figure 2-36 ML440 Cordless Handset

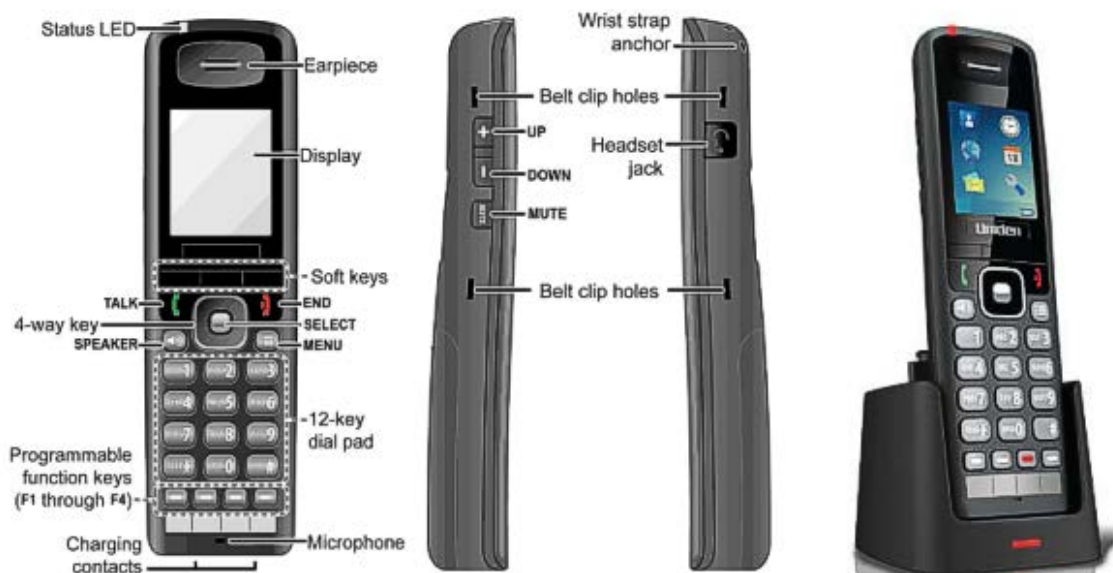

The ML440 has two sets of keys:

- ❑ Three soft keys that are dedicated depending on the state of the call and four programmable keys. The three dedicated soft keys are predefined depending on the state of the call. For example once a person is in conversation, these three keys are Hold / Conf./ Transfer. This makes it easy for end users to receive and move calls around.
- ❑ Four programmable keys on the base on the handset. The keys can be programmed for many of the same features that are supported on the DT800/DT700 desk sets.

Line key programming is flexible. The following is an example for the first three programmable keys:

- ❑ Line Keys 1 and 2 = CAP Keys
- ❑ Line Key 3 = Intercom Key

**Powering the AP20**

The AP20 can only be powered using Power over Ethernet (PoE) 802.3af.

A PoE switch is a switched hub that also provides power over the spare pairs. The switch can be used with other devices than the IP telephones and detects whether or not power is needed. Using a PoE switch makes it easier to protect the IP telephones from loss of power (connection of the PoE switch to an UPS).

**Updating the AP20 and ML440 System Firmware**

The firmware on base stations and handsets is updated remotely using the HTTP configuration interface to download firmware files from a TFTP server. Updating base station firmware involves an automatic reboot of the base station at the end of the firmware download. This will drop any active calls and in addition updating the handset firmware can take several hours. It is recommended updates are performed after normal business hours.



*Refer to the ML440 and AP20 System Installation Guide for detailed information.*

REFERENCE

**Handset Features**

Local Features	ML440
Calling name/number, call logging	Yes
Programmable keys	Yes up to 4
Talk time/standby	20/220
Handset LCD display	262K TFT type Color LCD with backlight. 176 x 220 pixel display
Built-in vibrator	Yes
Speakerphone mode	Yes
Bluetooth headset	No
Headset	Yes

Local Features	ML440
Backlit for keys	Yes
Volume key up/down	Yes
Mute key	Yes
Soft keys based on status call	Yes <input type="radio"/> Hold <input type="radio"/> Conference <input type="radio"/> Transfer
Centralized Directory	Yes

**Supported System Feature List**

Feature Name	ML440	Comment
Account Code – Forced Verified/Unverified	Yes	
Account Code Entry	Yes	
Alarm	Yes	There is a system and ML-440 alarm available
Alarm Reports	N/A	
Alphanumeric Display	Yes	
Analog Communications Interface (ACI)	N/A	
Ancillary Device Connection	N/A	
Answer Hold	No	
Answer Key	N/A	
Applications	N/A	
Attendant Call Queuing	No	
Automatic Release	N/A	
Automatic Route Selection	Yes	
Background Music	No	
Barge-In	Yes	Can monitor but cannot use the microphone toggle feature. The handset mute button is the only way to mute audio from handset during monitoring.
Call Appearance (CAP) Keys	Yes	
Call Arrival (CAR) Keys	Yes	
Call Duration Timer	No	
Call Forwarding	Yes	Can be programmed in 24-09-xx, through feature code from administrator desk set and from the phone using dial access codes.
Call Forwarding – Centrex	Yes	
Call Forwarding with Follow Me	Yes	



Feature Name	ML440	Comment
Call Forwarding with Park and Page	Yes	No recording beep is provided to handset user when setting up greetings.
Call Forwarding, All, BNA, Busy and Both Ring	Yes	Can be programmed in 24-09-xx, through feature code from administrator desk set and from the ML-440 using dial access codes.
Call Forwarding, Off-Premise	Yes	Can be programmed in 24-09-xx, through feature code from administrator desk set and from the ML-440 using dial access codes.
Call Forwarding/Do Not Disturb Override	Yes	
Call Monitoring	Yes	Can monitor but cannot use the microphone toggle feature. The handset mute button is the only way to mute audio from handset during monitoring.
Call Queuing	Yes	
Call Redirect	No	
Call Transfer	Yes	Supervised and Unsupervised.
Call Waiting/Camp-On	Yes	
Callback	Yes	
Caller ID	Yes	
Caller ID Return	Yes	
Central Office Calls, Answering	Yes	
Central Office Calls, Placing	Yes	
Class of Service	Yes	
Clock/Calendar Display	Yes	
CO Message Waiting Indication	No	
Code Restriction	Yes	
Code Restriction Override	Yes	
Code Restriction, Dial Block	Yes	No confirmation tone is heard on ML-440.
Computer Telephony Integration	No	
Conference Calls	Yes	
Conference, Voice Call/Privacy Release	Yes	
Contact Center	Yes	
Cordless Telephone Connection	N/A	
Data Line Security	Yes	
Delayed Ringing	Yes	
Department Calling	Yes	
Department Step Calling	Yes	

Feature Name	ML440	Comment
DeskTop Suite	No	
Dial Pad Confirmation Tone	No	
Dial Tone Detection	No	
Dialing Number Preview	No	This is a function of the ML-440 Handset.
Dialing Inward Dialing (DID)	Yes	
Direct Inward Line (DIL)	Yes	
Direct Inward System Access (DISA)	N/A	
Direct Station Selection (DSS) Console	No	A DSS Console cannot be associated with a ML-440 Handset
Directed Call Pickup	Yes	
Directory Dialing	No	This is a function of the ML-440 Handset.
Distinctive Ringing, Tones and Flash Patterns	No	Ring tones can be changed on the ML-440 Handset only.
Do Not Disturb	Yes	Do Not Disturb (DND) can be set from the ML-440 using dial access codes or a function key.
Door Box	Yes	Door Box will not ring a ML-440 phone but will flash the large LED. A ML-440 can call a door box but cannot activate a relay to open the door.
Drop Key	Yes	
E911/911	Yes	
Electra Elite Terminal Migration	N/A	
Facsimile CO Branch Connection	N/A	
Flash	No	
Flexible System Numbering	Yes	
Flexible Timeouts	Yes	
Forced Trunk Disconnect	No	
Group Call Pickup	Yes	
Group Listen	No	
Hands free	No	This is a function of the ML-440 Handset.
Hands free Answerback/Forced Intercom	No	
Handset Mute	No	This is a function of the ML-440 Handset.
Headset Operation	No	This is a function of the ML-440 Handset.
Hold	Yes	
Hotel/Motel	No	
Hotline	Yes	

Feature Name	ML440	Comment
Howler Tone Service	No	
InMail	Yes	Voice mail softkeys are not provided to the ML-440 Handset.
Intercom	Yes	
IP Multiline Station (SIP)	Yes	
IP Trunk – (SIP) Session Initiation Protocol	N/A	
IP Trunk – H.323	Yes	
ISDN Compatibility	Yes	
K-CCIS – IP	Yes	If ML440 Cordless phones are required to call across K-CCIS-IP, peer-to-peer must be disabled in Program 15-5-50 for the ML440 stations.
K-CCIS – T1	Yes	
Last Number Redial	No	Call Redial function is a function of the ML-440 Handset.
Line Preference	No	
Long Conversation Cutoff	Yes	
Meet Me Conference	Yes	Can initiate a Meet Me Conference but cannot receive internal pages to join an Internal Meet Me Page.
Meet Me Paging	Yes	Can initiate a Meet Me Paging but cannot receive internal pages to respond to an Internal Meet Me Page.
Meet Me Paging Transfer	Yes	Can initiate a Meet Me Paging but cannot receive internal pages to respond to an Internal Meet Me Transfer Page.
Memo Dial	No	
Message Waiting Indication (MWI)	Yes	Only supports voice mail MWI.
Microphone Cutoff	Yes	This is a function of the ML-440 Handset.
Multiple Trunk Types	Yes	
Music on Hold	No	Callers to a ML440 hear SV9100 MOH. Calls made from ML440 handsets do not hear MOH.
Name Storing	No	
NEC Interactive Voice Response	Yes	
Netlink	Yes	
Night Service	No	
Off-Hook Signaling	No	
Off-Premise Extension	N/A	

Feature Name	ML440	Comment
One-Touch Calling	Yes	Must press Line Key then go Off-hook on ML-440 for stored number to be dialed.
Operator	No	A ML-440 should not be used as an operator phone.
Paging, External	Yes	A ML-440 can only initiate an Internal, External or All Call Page. It cannot receive either Internal or All Call pages or display page information.
Paging, Internal	Yes	A ML-440 can only initiate an Internal, External or All Call Page. It cannot receive either Internal or All Call pages or display page information.
Park	Yes	
PBX Compatibility	Yes	
PC Programming	Yes	
Personal Park	Yes	
Power Failure Transfer	No	
Prime Line Selection	Yes	Prime Line Selection can be assigned for a ML-440 however, when this is done the phone cannot access ICM dial tone. In addition the ML-440 does not follow program 20-08-21 settings.
Private Line	Yes	
Programmable Function Keys	Yes	
Programming from a Multiline Terminal	No	
Pulse to Tone Conversion	No	
Quick Transfer to Voice Mail	Yes	
Repeat Redial	No	
Reverse Voice Over	No	
Ring down Extension, Internal/External	Yes	A ML-440 can be a ring down destination but cannot originate a ring down call.
Ring Groups	Yes	
Room Monitor	No	A ML-440 can be monitored but cannot monitor other extensions.
Save Number Dialed	Yes	
Secondary Incoming Extension	Yes	
Secretary Call (Buzzer)	Yes	
Secretary Call Pickup	Yes	Voice announcement is not supported on ML-440 Handset
Selectable Display Messaging	Yes	
Selectable Ring Tones	No	Selectable Ring Tones is a function of the ML-440 and not the phone system.

Feature Name	ML440	Comment
Serial Call	Yes	
Single Line Telephones, Analog 500/2500 sets	N/A	
Softkeys	No	ML-440 Handset Softkeys are fixed and do not follow SV9100 Softkey settings.
Speed Dial – Group	Yes	Group speed dial bins are only available using function line key (28).
Speed Dial – System	No	
Speed Dial – Station	No	
Station Hunt	Yes	
Station Message Detail Recording	Yes	
Station Name Assignment – User Programmable	Yes	ML-440 Handset power must be cycled for change to show on handset.
Station Relocation	Yes	No confirmation tone is heard. ML-440 Handset must have the power cycled to re-register with the AP20 base unit.
SV9100 Communications Analyst Enterprise	Yes	
SV9100 UC Suite	No	
SV9100 PoE Gigabit Switch	Yes	
SV9100 Terminals	N/A	
Synchronous Ringing	No	
T1 Trunking (with ANI/DNIS Compatibility)	Yes	
Tandem Ringing	No	
Tandem Trunking (Unsupervised Conference)	Yes	
TAPI Compatibility	No	
Tone Override	Yes	
Traffic Reports	No	
Transfer	Yes	
Trunk Group Routing	Yes	
Trunk Groups	Yes	
Trunk Queuing/Camp-On	No	
UM8000	Yes	Voice mail softkeys are not provided to the ML-440 Handset.
Uniform Call Distribution UCD)	Yes	
Uniform Numbering Network	Yes	
User Programming Ability	Yes	
Virtual Extension	Yes	

Feature Name	ML440	Comment
Voice Mail Integration (Analog)	Yes	
Voice Over	Yes	ML-440 can initiate voice over but cannot respond to voice from another extension.
Voice Over Internet Protocol (VoIP)	Yes	By nature, this is a SIP device.
Voice Response System (VRS) – Call	Yes	
Volume Controls	No	Volume control is a function of the ML-440 Handset and not the phone system.

## Conditions

- The maximum number of ML440 Handsets that can register to one AP20 Access Point is 30.
- The maximum number of ML440 Handsets supported in one SV9100 system is 200.
- The maximum number of AP20 Access Points supported on one SV9100 is 40.
- In a multi-cell system each AP20 supports a maximum of eight simultaneous voice paths.
- The ML440 does not support voice announce calls. If the SV9100 is set to voice in Program 20-02-12, each phone should dial use access code 723 to set the phone to ring on internal calls. The ML440 should also be put in their own class of service with Program 20-08-11 enabled.
- In a single base (AP20) system the AP20 supports a maximum of 10 simultaneous voice paths.
- The ML440 and AP20 system uses NEC i-SIP for SV9100.
- The ML440 and AP20 system supports the G.711 Codec only.
- The ML440 Handset and AP20 Access Point are not supported in UX5000 or UX5000 Migration systems.
- The ML440 handset supports Peer-to-Peer in a standalone system only. When used in a CCISoIP system Peer-to-Peer (Program 15-05-50) must be disabled.
- The ML440 Handset does not support the Live Monitor feature.
- The line keys on the ML440 correspond to Line Keys 1-4 in Program 15-07-01 for that phones extension.
- The three dedicated soft keys are predefined depending on the state of the call.
- The ML440 will follow the ring no answer timing whenever the ML440 handset either is turned off or is out of range of an AP20.
- The SV9100 requires one IP Terminal license (5111), one Port License (0300) and one VoIP Resource License (5103) per ML440 handset.

- The ML440 and AP20 system software is upgraded over-the-air direct to handsets and access points.
- The AP20 can only be powered using Power over Ethernet (PoE) 802.3af.
- The ML440 and AP20 system supports seamless roaming between Base Units.
- The ML440 and AP20 system are not supported for use with DeskTop Suite.
- The ML440 and AP20 system cannot be used on multiple SIP servers at the same time.
- NAT or NAPT is only supported on DT800/DT700 series phones. NAT or NAPT is not supported on the ML440, the Wireless DECT (SIP), Softphone and third party SIP phones.
- For CID to appear in the call log of the ML440 for all trunk types, Programs 15-02-13 and 15-02-34 must be set for Extension/Trunk. Also, Program 15-05-28 must be set to On for the ML440 extensions.
- Registration Type Plug-In-Play must be used when using ML440s with AP20s.

### Default Settings

None

## System Availability

### Terminals

ML440 Handset

### Required Component(s)

- AP20 Base Unit
- 0411 – SV9100 Version Lic (R1)
- 0300 – SV9100 Resource Lic
- 5103 – SV9100 IP Resource Lic
- 5111 – SV9100 IP Phone Lic

## Related Features

- ➔ **Call Appearance (CAP) Keys**
- ➔ **Intercom**
- ➔ **IP Multiline Station (SIP)**

## Guide to Feature Programming

The **Level 1**, **Level 2** and **Level 3** columns indicate the programs that are assigned when programming this feature in the order they are most commonly used. These levels are used with PCPro and WebPro wizards for feature programming.

- Level 1 – these are the most commonly assigned programs for this feature.
- Level 2 – these are the next most commonly assigned programs for this feature.
- Level 3 – these programs are not often assigned and require an expert level working knowledge of the system to be properly assigned.

Program Number	Program Name/Description	Input Data	Default	Level		
				1	2	3
10-12-01	<b>GCD-CP10 Network Setup – IP Address</b> Assign the IP address.	0.0.0.0 ~ 126.255.255.254 128.0.0.1 ~ 191.255.255.254 192.0.0.1 ~ 223.255.255.254	192.168.0.10		✓	
10-12-03	<b>GCD-CP10 Network Setup – Default Gateway</b> Assign the default gateway IP address for the GCD-CP10.	0.0.0.0 ~ 126.255.255.254 128.0.0.1 ~ 191.255.255.254 192.0.0.1 ~ 223.255.255.254	0.0.0.0	✓		
10-12-09	<b>GCD-CP10 Network Setup – IP Address</b> Set IP address for GPZ-IPLE. ➡ <i>The IP Address assigned in Program 10-12-01 cannot start with the same leading digits as the IP Address assigned here.</i>	0.0.0.0 ~ 126.255.255.254 128.0.0.1 ~ 191.255.255.254 192.0.0.1 ~ 223.255.255.254	172.16.0.10	✓		
10-12-10	<b>GCD-CP10 Network Setup – Subnet Mask</b> Set the subnet mask of the GPZ-IPLE.	128.0.0.0   192.0.0.0   224.0.0.0  240.0.0.0   248.0.0.0   252.0.0.0  254.0.0.0   255.0.0.0  255.128.0.0   255.192.0.0  255.224.0.0   255.240.0.0  255.248.0.0   255.252.0.0  255.254.0.0   255.255.0.0  255.255.128.0   255.255.192.0  255.255.224.0   255.255.240.0  255.255.248.0   255.255.252.0  255.255.254.0   255.255.255.0  255.255.255.128  255.255.255.192  255.255.255.224  255.255.255.240  255.255.255.248  255.255.255.252  255.255.255.254  255.255.255.255	255.255.0.0		✓	
10-13-01	<b>DHCP Server Mode</b> Enable/Disable the built-in DHCP Server.	0 = Disable 1 = Enable	0		✓	
10-13-02	<b>Lease Time</b> Lease time of the IP address to a client. Press the Transfer Key to increment to the next setting data.	Days 0 ~ 255 Hour 0 ~ 23 Minutes 0 ~ 59	0 day 0 hour 30 minutes		✓	



Program Number	Program Name/Description	Input Data	Default	Level		
				1	2	3
10-13-05	<p><b>Last DHCP Data</b></p> <p>If 10-13-01 is enabled, this setting determines if DHCP resource is enabled or disabled.</p>	<p>0 = Disable</p> <p>1 = Enable</p>	1		✓	
10-54-01	<p><b>License Configuration for Each Package – License Code</b></p> <p>Assign VoIP Resource Licenses (5103) to GCD-CP10 slot (1).</p> <p>If applying more than 255 licenses to a slot, the licenses must be applied across multiple indexes.</p> <p>For example, assigning 256 VoIP resource licenses (5103) to the CPU slot could be assigned using different methods as long as the total for the CPU slot is 256.</p> <p>1. Index 1 has 128 of feature code 5103 and index 2 also has 128 of feature code 5103 for a total of 256.</p> <p>2. Index 1 has 255 of feature code 5103 and index 2 has 1 of feature code 5103 for a total of 256.</p>	1 ~ 255 Resource Licenses	0		✓	
15-05-50	<p><b>IP Telephone Terminal Basic Data Setup – Peer to Peer Mode</b></p> <p>On a per station basis enable or disable Peer to Peer mode.</p>	<p>0 = Disable</p> <p>1 = Enable</p>	1	✓		
15-07-01	<p><b>Programmable Function Keys</b></p> <p>Assign functions to multiline terminal line keys. NEC recommends the following for the first three programmable keys:</p> <p>Line Keys 1 and 2 = CAP Keys</p> <p>Line Key 3 = Intercom Key</p>	<p>Line Key 1 ~ 48</p> <p>0 ~ 99 (Normal Function Code 751 by default)</p> <p>*00 ~ *99 (Appearance Function Code) (Service Code 752 by default)</p> <p>(*08 + XXXX = CAP key where XXXX is the CAP orbit number 0001-9999)</p>	Refer to the Programming Manual for default values.		✓	
15-02-13	<p><b>Multiline Telephone Basic Data Setup – Outgoing Caller List Mode</b></p> <p>Select the type of numbers that are stored in the Redial List – Internal and External numbers (0) or External only (1).</p> <p>➡ For the ML440 extensions this should be set to 0.</p>	<p>0 = ICM/Trunk (Extension/Trunk Mode)</p> <p>1 = Trunk Mode</p>	1		✓	
15-02-34	<p><b>Multiline Telephone Basic Data Setup – Call Register Mode</b></p> <p>The Caller ID Scroll stores Trunk calls only (0), or both Internal and Trunk calls (1).</p> <p>➡ For the ML440 extensions this should be set to 1.</p>	<p>0 = Trunk Mode</p> <p>1 = Extension/Trunk Mode</p>	0		✓	

Program Number	Program Name/Description	Input Data	Default	Level		
				1	2	3
15-05-28	<p><b>IP Telephone Terminal Basic Data Setup – Addition Information Setup</b></p> <p>Determines manner in which CID id presented to an extension.</p> <p>➡ For the ML440 extensions this should be set to 1.</p>	0 = Do not inform 1 = Inform	0	✓		
20-02-12	<p><b>System Options for Multiline Telephones – Forced Intercom Ring (ICM Call Type)</b></p> <p>Enable/Disable Forced Intercom Ringing. If enabled, incoming Intercom calls normally ring. If disabled, Intercom calls voice-announce.</p>	0 = Disable (Voice) 1 = Enable (Signal)	0	✓		
20-06-01	<p><b>Class of Service for Extensions</b></p> <p>Assign ML440 handsets to their own Class of Service.</p>	Day Night/Mode: 1 ~ 8 Class of Service of Extensions (1 ~ 15)	Extension port 101 = Class 15 All other extension port = Class 1	✓		
20-08-11	<p><b>Class of Service Options (Outgoing Call Service) – Protect for the Call Mode Switching from Caller</b></p> <p>Set this option for the ML440 Class of Service. When an extension is set to ring mode for ICM calls, enabling this option prevents callers from changing the call to voice announce mode.</p>	0 = Off 1 = On	COS 1 ~ 15 = 0	✓		
24-09-01	<p><b>Call Forward Split Settings – Call Forwarding Type:</b></p> <p>Assign Call Forwarding Type and the destination numbers for each extension/virtual extension.</p>	0 = Call Forwarding Off 1 = Call Forwarding with both ring 2 = Call Forwarding when no answer 3 = Call Forwarding all calls 4 = Call Forwarding busy or no answer 5 = Call Forwarding when busy	0		✓	
24-09-02	<p><b>Call Forward Split Settings – CO Call Forwarding Destination for Both Ring, All Call, No Answer</b></p> <p>Assign CO Call Forwarding Destination for ring, all call, and no answer.</p>	1 ~ 9, 0, #, *, R, @ Maximum of 24 digits	No Setting		✓	
24-09-03	<p><b>Call Forward Split Settings – Intercom Call Forwarding Destination for Both ring, All Call, No Answer</b></p> <p>Assign Intercom Call Forwarding Destination for ring, all call and no answer.</p>	1 ~ 9, 0, #, *, R, @ Maximum of 24 digits	No Setting		✓	
24-09-04	<p><b>Call Forward Split Settings – CO Call Forwarding Busy Destination</b></p> <p>Assign CO Call Forwarding for busy destinations.</p>	1 ~ 9, 0, #, *, R, @ Maximum of 24 digits	No Setting		✓	

Program Number	Program Name/Description	Input Data	Default	Level		
				1	2	3
24-09-05	<b>Call Forward Split Settings – Intercom Call Forwarding Busy Destination</b> Assign Intercom Call Forwarding for busy destinations.	1 ~ 9, 0, #, *, R, @ Maximum of 24 digits	No Setting		✓	
24-09-06	<b>Call Forward Split Settings – Call Forwarding Destination for CTX/PBX for All Call, No Answer</b> Assign Call Forwarding for CTX/PBX all call, no answer destinations.	1 ~ 9, 0, #, *, R, @ Maximum of 24 digits	No Setting		✓	
24-09-07	<b>Call Forward Split Settings – Call Forwarding Destination for CTX/PBX for Busy</b> Assign Call Forwarding destinations for busy CTX/PBX calls.	1 ~ 9, 0, #, *, R, @ Maximum of 24 digits	No Setting		✓	
84-24-28	<b>DT800/DT700 Multiline CODEC Information Basic Setup – Audio Capability Priority</b> Set voice (RTP packet) encoding parameters. The ML440 only supports G.711.	0 = G.711_PT 2 = G.729_PT	0		✓	
84-26-01	<b>IPL Basic Setup – IP Address</b> Assign the IP address for the DSP on the GPZ-IPLE.	xxx.xxx.xxx.xxx	172.16.0.20	✓		
84-26-02	<b>IPL Basic Setup – RTP Port Number</b> Assign the RTP port number to be used for each DSP on the GPZ-IPLE. ➡ <i>Only even numbered ports are supported.</i>	0 ~ 65534	10020		✓	
84-26-03	<b>IPL Basic Setup – RTCP Port Number (RTP Port Number + 1)</b> Define the UDP port number for RTCP to use for each DSP.	0 ~ 65534	10021		✓	

## Operation



REFERENCE

*Refer to the ML440 User Guide for detailed operation information.*

## IP Multiline Station (SIP) – ML440/G566/G266 with AP400/AP300

### Description

#### ML440:

Many SMB businesses, understanding the impact of a mobile workforce, are rapidly defining their requirements for enabling effective communications and information access for mobile users. SMB Mobility will allow the individual staff member to be instantly accessible thus becoming more productive.

The ML440 IP Wireless Handset is an ergonomically designed compact wireless handset for business users who are mobile in the office and want to make and receive wireless calls while in the office. The DECT protocol operates in the 1.9 GHz frequency band that has been cleared specifically for voice applications, thus avoiding any interference problems and delivering crystal clear and secure voice conversations.

The ML440 provides numerous features and conveniences for optimal comfort. Its illuminated graphic color LCD display enables use in poorly lit environments, while its internal loudspeaker provides handsfree operation with excellent sound quality. Powerful encryption techniques ensure secure communication, and it can also provide the subscriber with most of the features available for a wired phone, in addition to its roaming and handover capabilities.

Unlike other in-building wireless solutions for the SV9100, the ML440 is an integrated multiline handset capable of supporting the key elements of a SMB mobile solution. A complete list of supported features can be found below.

### Basic Operation

Figure 2-37 ML440 Cordless Handset

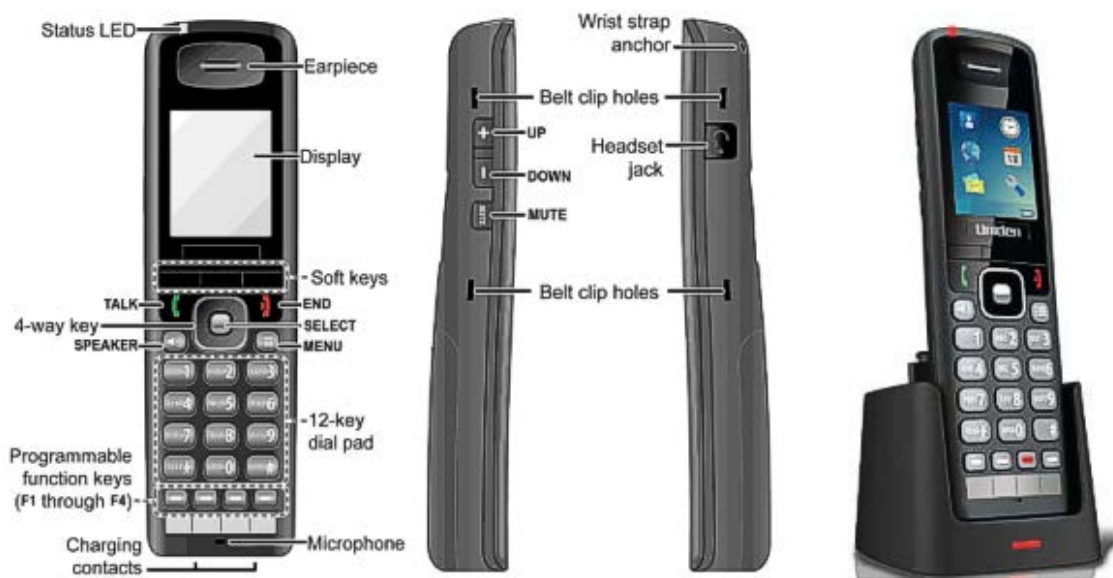

The ML440 has two sets of keys:

- ❑ Three softkeys that are dedicated depending on the state of the call and four programmable keys. The three dedicated softkeys are predefined depending on the state of the call. For example once a person is in conversation, these three keys are Hold / Conf./ Transfer. This makes it easy for end users to receive and move calls around.
- ❑ Four programmable keys on the base on the handset. The keys can be programmed for many of the same features that are supported on the DT800/DT700 desk sets.

Line key programming is flexible. The following is an example for the first three programmable keys:

- ❑ Line Keys 1 and 2 = CAP Keys
- ❑ Line Key 3 = Intercom Key

**G566 and G266:**

The G566 and G266 operate as standard SIP devices when connected to a SV9100. The line keys on the G566 are not functional in this application.

---

*Figure 2-38 G566 and G266 in Desktop Charger*



**Powering the AP400/AP300**

The AP400/AP300 can only be powered using Power over Ethernet (PoE) 802.3af. A PoE switch is a switched hub that also provides power over the spare pairs. The switch can be used with other devices than the IP telephones and detects whether or not power is needed. Using a PoE switch makes it easier to protect the IP telephones from loss of power (connection of the PoE switch to an UPS).

## Updating the AP400 and ML440/G566/G266 System Firmware

The firmware on base stations and handsets is updated remotely using the HTTP configuration interface to download firmware files from a TFTP server. Updating base station firmware involves an automatic reboot of the base station at the end of the firmware download. This will drop any active calls and in addition updating the handset firmware can take several hours. It is recommended updates are performed after normal business hours.



— *Refer to the UNIVERGE SV9100 IP-DECT Customer Engineer Manual for additional information.*

### Conditions

- DAP Manager is required to support AP400 Access Points and ML440 handsets.
- The ML440 handset requires AP400 Access Points.
- The DAP manager does not support Internet Explorer 10 (IE 10).
- Only AP400 and AP300 DAPs are supported for ML440/G566/G266 handsets.
- The AP400/AP300 with ML440/G566/G266 handsets are not supported behind NAT routers.
- The line keys on the ML440 correspond to Line Keys 1-4 in Program 15-07-01 for that phones extension.
- The line keys on the G566 handset do not function when connected to a SV9100.
- The three dedicated softkeys on the ML440 are predefined depending on the state of the call and the handset type used.
- 12 simultaneous calls can be made per AP400/AP300 Access Point.
- The maximum number of AP400/AP300 DAPs is 256.
- The ML440/G566/G266 and AP400/AP300 will follow the Ring No Answer timing whenever the ML440 handset is either turned off or out of range of an AP400.
- The SV9100 requires one IP Terminal license (5111), one Port License (0300) and one VoIP Resource License (5103) per ML440, G566 or G266 handset.
- The G566 and G266 handsets do not support Peer-to-Peer.
- The ML440 handset supports Peer-to-Peer in a standalone system only. When used in a CCISoIP system Peer-to-Peer (Program 15-05-50) must be disabled.
- The AP400/AP300 can only be powered using Power over Ethernet (PoE) 802.3af.
- The ML440/G566/G266 firmware is upgraded over-the-air to handsets.
- The ML440/G566/G266 and AP400/AP300 system supports seamless roaming between Base Units.

- The ML440/G566/G266 and AP400/AP300 system are not supported for use with DeskTop Suite.
- The ML440/G566/G266 and AP400/AP300 system cannot be used on multiple SIP servers at the same time.
- The ML440/G566/G266 and AP400/AP300 do not support voice announce calls. If the SV9100 is set to voice in Program 20-02-12 then each phone should use access code 723 to set the phone to ring on internal calls.
- The ML440/G566/G266 should be put in their own class of service with Program 20-08-11 enabled.
- The ML440/G566/G266 with AP400/AP300 only supports the G.711 Codec and 20ms frame size.
- For CID to appear in the call log of the ML440 for all trunk types, Programs 15-02-13 and 15-02-34 must be set for Extension/Trunk. Also, Program 15-05-28 must be set to On for the ML440 extensions.

Table 2-59 Handset Features

Local Feature	ML440	G566	G266
Calling name/number, call logging	Yes	Yes	Yes
Programmable keys	Yes up to 4	No	No
Talk time/standby	20/220	–	–
Handset LCD display	262K TFT type Color LCD w/backlight. 176 x 220 pixel display	–	–
Built-in vibrator	Yes	Yes	Yes
Speakerphone mode	Yes	Yes	Yes
Bluetooth® headset	No	No	No
Headset connection	Yes	Yes	Yes
Backlit for keys	Yes	Yes	No
Volume key up/down	Yes	Yes	Yes
Mute key	Yes	Yes	Yes
Softkeys based on status call	Yes – Hold – Conference – Transfer	Yes – Mute – –	Yes – Mute – –
Centralized directory	Yes	Yes	Yes

Table 2-60 Supported System Feature List

Feature Name	ML440	G566	G266	Comments
Account Code - Forced/Verified/Unverified	Yes	Yes	Yes	
Account Code Entry	Yes	Yes	Yes	
Alarm	Yes	Yes	No	Supported Alarms: ML440 – System and handset alarm available. G566 – System and handset alarm available.
Alarm Reports	No	No	No	
Alphanumeric Display	Yes	Yes	Yes	Time and Date Display: – ML440 obtains time and date from SV9100 system. – G566/G266 time and date is obtained from the DAP controller PC. Name: – ML440 obtains display name from network domain. – G566/G266 name is assigned per handset and does not use the SV9100 system name.
Analog Communications Interface (ACI)	No	No	No	
Ancillary Device Connection	No	No	No	
Answer Hold	No	No	No	
Answer Key	No	No	No	
Applications	No	No	No	
Attendant Call Queuing	No	No	No	
Automatic Release	Yes	Yes	Yes	
Automatic Route Selection (ARS)	Yes	Yes	Yes	
Background Music	No	No	No	
Barge-In	Yes	No	No	ML440 – Can monitor but cannot use the microphone toggle feature. The handset mute button is the only way to mute audio from handset during monitoring. G566/G266 – Can be barged into but cannot initiate Barge-In.
Call Appearance (CAP) Keys	Yes	No	No	
Call Arrival (CAR) Keys	Yes	No	No	
Call Duration Timer	No	No	No	G566/G266 will show call duration briefly after hanging up. More detailed call history information is available on the call history log page.
Call Forwarding – Centrex	Yes	Yes	Yes	
Call Forwarding with Follow Me	Yes	Yes	Yes	Only supported on G566/G266 when connected to system (In Range).
Call Forwarding – Park and Page	No	No	No	
Call Forwarding All Calls	Yes	Yes	Yes	Can be programmed in 24-09-xx, through feature code from administrator desk set and from the handset using dial access codes.



Table 2-60 Supported System Feature List (Continued)

Feature Name	ML440	G566	G266	Comments
Call Forwarding Both Ring	Yes	Yes	Yes	Only supported on G566/G266 when connected to system (In Range).
Call Forwarding Busy	Yes	Yes	Yes	
Call Forwarding Busy No Answer	Yes	Yes	Yes	
Call Forwarding, Off-Premise	Yes	Yes	Yes	Can be programmed in 24-09-xx, through feature code from administrator desk set and from the handset using dial access codes.
Call Forwarding/Do Not Disturb Override	Yes	Yes	Yes	ML440 – Do Not Disturb Override can be performed using dial access codes or a function key. G566/G266 – Do Not Disturb Override can be performed using dial access codes only.
Call Monitoring	Yes	Yes	Yes	ML440/G566/G266 – Can monitor but cannot use the microphone toggle feature. The handset will not be able to Barge-In to the conversation only monitor.
Call Redirect	Yes	No	No	
Call Waiting/Camp-On	Yes	Yes	Yes	ML440 – Call Waiting/Camp-On can be performed using dial access codes or a function key. G566/G266 – Call Waiting/Camp-On can be performed using dial access code only.
Callback	Yes	No	No	G566/G266 – handsets can receive a Callback but cannot set one for another phone.
Caller ID	Yes	Yes	Yes	
Caller ID Caller Return	Yes	Yes	Yes	Function of handset.
Central Office Calls, Answering	Yes	Yes	Yes	
Central Office Calls, Placing	Yes	Yes	Yes	
Class of Service	Yes	Yes	Yes	
Clock/Calendar Display	Yes	Yes	Yes	Time and Date Display: – ML440 obtains time and date from SV9100 system. – G566/G266 time and date is set manually per handset.
CO Message Waiting Indication	No	No	No	
Code Restriction	Yes	Yes	Yes	
Code Restriction Override	Yes	No	No	
Code Restriction, Dial Block	Yes	Yes	Yes	ML440 – No confirmation tone is heard on ML440. G566/G266 – Only non-supervisor dial access code 600 is supported for these handsets. The G566/G266 cannot enable or disable this feature for another extension.
Computer Telephony Integration	No	No		
Conference Calls	Yes	No	No	
Conference, Voice Call/Privacy Release	Yes	No	No	
Contact Center	Yes	No	No	

Table 2-60 Supported System Feature List (Continued)

Feature Name	ML440	G566	G266	Comments
Cordless Telephone Connection	No	No	No	
Data Line Security	Yes	No	No	
Delayed Ringing	Yes	No	No	
Department Calling	Yes	Yes	Yes	
Department Step Calling	Yes	No	No	
Desktop Suite	No	No	No	
Dial Pad Confirmation Tone	No	No	No	
Dial Tone Detection	No	No	No	
Dialing Number Preview	No	Yes	Yes	This is a function of the handset.
Direct Inward Dialing (DID)	Yes	Yes	Yes	
Direct Inward Line (DIL)	Yes	Yes	Yes	
Direct Inward System Access (DISA)	No	No	No	
Direct Station Selection Key	No	No	No	
Direct Station Selection (DSS) Console	No	No	No	A DSS Console cannot be associated with a ML440/G566/G266 handset.
Directed Call Pickup	Yes	No	No	
Directory Dialing	No	No	No	This is a function of the ML440/G566/G266 handset.
Distinctive Ringing, Tones and Flash Patterns	No	No	No	Ring tones can be changed on the ML440/G566/G266 handset only.
Do Not Disturb	Yes	Yes	Yes	ML440 – Do Not Disturb (DND) can be set using dial access codes or a function key but no confirmation tones are provided. G566/G266 – Do Not Disturb (DND) can be set using dial access codes only.
Door Box	Yes	Yes	Yes	ML440 – A Door Box will not ring a ML440 phone but will flash the large LED. A ML440 can call a door box but cannot activate a relay to open the door. G566/G266 – A Door Box will ring a G566/G266 but they cannot activate a relay to open the door. A G566/G266 can call a door box but cannot activate a relay to open the door.
Drop Key	Yes	No	No	
E911/911	Yes	No	No	
Flash	No	No	No	
Flexible System Numbering	Yes	Yes	Yes	
Flexible Timeouts	Yes	Yes	Yes	
Forced Trunk Disconnect	No	No	No	
Group Call Pickup	Yes	Yes	Yes	
Group Listen	No	No	No	

Table 2-60 Supported System Feature List (Continued)

Feature Name	ML440	G566	G266	Comments
Handset Mute	Yes	Yes	Yes	This is a function of the handset.
Handsfree	Yes	Yes	Yes	This is a function of the handset.
Handsfree Answerback/Forced Intercom	No	No	No	
Headset Operation	Yes	Yes	Yes	This is a function of the handset.
Hold	Yes	Yes	Yes	G566/G266 supported system hold only.
Hotel/Motel	No	No	No	
Hotline	Yes	No	No	ML440 – The ML440 does not follow Hotline for speaker 20-08-19 only Hotline for hand piece 20-08-09.
Howler Tone Service	No	No	No	
InMail	Yes	Yes	Yes	Voice mail softkeys are not provided to handset. Live monitor is not supported.
Intercom	Yes	Yes	Yes	
IP Multiline Station (SIP)	Yes	No	No	
IP Single Line Telephone (SIP)	No	Yes	Yes	
IP Trunk – (SIP) Session Initiation Protocol	Yes	Yes	Yes	
IP Trunk – H.323	Yes	Yes	Yes	
ISDN Compatibility	Yes	Yes	Yes	
K-CCIS – IP	Yes	Yes	Yes	The following programs must be disabled, set to 0, when using a ML440 handset in a CCISoIP network: Peer-to-Peer – 15-05-50 (0) Link Reconnect – 50-06-01 (0)
K-CCIS – T1	Yes	Yes	Yes	
Last Number Redial	Yes	Yes	Yes	Call Redial function is a function of the handset.
Line Preference	Yes	No	No	
Long Conversation Cutoff	Yes	Yes	Yes	With ML440 an alarm tone is not provided before cutoff.
Meet Me Conference	Yes	No	No	The ML440 can initiate a Meet Me Conference but cannot receive internal pages to join an internal Meet Me Conference.
Meet Me Paging	Yes	Yes	Yes	Can initiate a Meet Me Paging but cannot receive internal pages to respond to an Internal Meet Me Page.
Meet Me Paging Transfer	Yes	Yes	Yes	Can initiate a Meet Me Paging Transfer but cannot receive internal pages to respond to an Internal Meet Me Transfer page.
Memo Dial	No	No	No	
Message Waiting Indication (MWI)	Yes	No	No	ML440 only supports voice mail MWI.
Microphone Cutoff	Yes	Yes	Yes	This is a function of the ML440 handset.

Table 2-60 Supported System Feature List (Continued)

Feature Name	ML440	G566	G266	Comments
Multiple Trunk Types	Yes	Yes	Yes	
Music on Hold	Yes	Yes	Yes	Intercom Calls: – ML440 does not receive MOH. – G566/G266 does receive MOH. Trunk Calls: – All handsets receive MOH from distant system.
Name Storing	No	No	No	
NEC Interactive Voice Response	Yes	Yes	Yes	
NetLink	Yes	Yes	Yes	
Night Service	No	No	No	
Off-Hook Signaling	No	No	No	
Off-Premise Extension	No	No	No	
One-Touch Calling	Yes	No	No	Must press line key then go Off-hook on ML440 for stored number to be dialed.
Operator	No	No	No	A wireless handset should not be used as an operator phone.
Paging, External	Yes	Yes	Yes	A ML440/G566/ZG266 can only initiate an External or All Call Page. It cannot receive either Internal or All Call Pages or display page information.
Paging, Internal	Yes	Yes	Yes	A ML440/G566/ZG266 can only initiate an External or All Call Page. It cannot receive either Internal or All Call Pages or display page information.
Park	Yes	Yes	Yes	
PBX Compatibility	Yes	Yes	Yes	
PC Programming	Yes	Yes	Yes	
Personal Park	Yes	No	No	
Power Failure Transfer	No	No	No	
Prime Line Selection	Yes	Yes	Yes	Prime Line Selection can be assigned for ML440/G566/G266 handsets. However, when this is done the phone cannot access ICM dial tone.
Private Line	Yes	Yes	Yes	
Programmable Function Keys	Yes	No	No	
Programming from a Multiline Terminal	No	No	No	
Pulse to Tone Conversion	Yes	No	No	
PVA Conference Bridge	Yes	No	No	
Quick Transfer to Voice Mail	Yes	Yes	Yes	– ML440 can receive and make Quick Transfer to VM calls. – G566/G266 can only receive Quick Transfer to VM calls.
Repeat Redial	Yes	No	No	

Table 2-60 Supported System Feature List (Continued)

Feature Name	ML440	G566	G266	Comments
Reverse Voice Over	Yes	No	No	
Ringdown Extension, Internal/ External	Yes	Yes	Yes	ML440 – The ML440 does not follow Hotline for speaker 20-08-19 only Hotline for hand piece 20-08-09. G566/G266 – The G566/G266 can be a hotline destination, but cannot originate a hotline call.
Ring Groups	Yes	Yes	Yes	
Room Monitor	No	No	No	
Save Number Dialed	Yes	Yes	Yes	
Secondary Incoming Extension	Yes	No	No	
Secretary Call (Buzzer)	Yes	No	No	
Secretary Call Pickup	Yes	No	No	Voice announcement is not supported on ML440 handset.
Selectable Display Messaging	Yes	No	No	
Selectable Ring Tones	Yes	Yes	Yes	Selectable Ring Tones is a function of the handset and not the phone system.
Serial Call	Yes	No	No	
Single Line Telephones, Analog 500/2500 Sets	No	No	No	
Softkeys	No	No	No	All handset softkeys are fixed and do no follow SV9100 soft key settings.
Speed Dial - System/Group/Station	Yes	Yes	Yes	ML440 – Speed dial bins are available using function line key (28 for group and 27 for system) and dial access codes. G566/G366 – Must use dial access codes to use speed dial feature. – Cannot be used to program speed dial entries.
Station Hunt	Yes	Yes	Yes	
Station Message Detail Recording	Yes	Yes	Yes	
Station Name Assignment – User Programmable	No	No	No	
Station Relocation	No	No	No	
SV9100 Desktop Applications	No	No	No	
Synchronous Ringing	No	No	No	
T1 Trunking (with ANI/DNIS Compatibility)	Yes	Yes	Yes	
Tandem Ringing	No	No	No	
Tandem Trunking (Unsupervised Conference)	Yes	No	No	The Unsupervised Conference will be disconnected automatically based on Program 24-02-07.
TAPI Compatibility	No	No	No	
Tone Override	Yes	No	No	

Table 2-60 Supported System Feature List (Continued)

Feature Name	ML440	G566	G266	Comments
Transfer	Yes	Yes	Yes	ML440 – Supervised and Unsupervised. G566/G266 – Supervised only.
Trunk Group Routing	Yes	Yes	Yes	
Trunk Groups	Yes	Yes	Yes	
Trunk Queuing/Camp-On	Yes	No	No	ML440 must use feature key programmed with Trunk Queue function (35).
UM8000 Mail	Yes	Yes	Yes	Voice mail softkeys are not provided to ML440/G566/G266 handsets.
Uniform Call Distribution (UCD)	Yes	Yes	Yes	G566/G266 handsets can be members of a UCD group, but since they do not support programmable feature keys have no way to remove or add themselves to the group.
Uniform Numbering Network	Yes	Yes	Yes	
User Programming Ability	Yes	No	No	
Virtual Extensions	Yes	No	No	
Voice Mail Integration (Analog)	Yes	Yes	Yes	
Voice Over	Yes	No	No	ML440 can initiate voice over but cannot respond to a voice from another extension.
Voice Over Internet Protocol (VoIP)	Yes	Yes	Yes	By nature, these are SIP devices.
Voice Response System (VRS) – Call	Yes	No	No	The ML440 can be used to record and erase VRS messages. However, no beep to record or confirmation beep is provided, so it is not recommended.
Volume Controls	Yes	Yes	Yes	Volume control is a function of the ML440/G566/G266 handset, not the phone system.

### Default Setting

None

### System Availability

#### Terminals

- ML440 Handset
- G566 Handset
- G266 Handset

### Required Component(s)

- AP400 Base Unit
- 5111 – SV9100 IP Phone Lic, one for each G566 or G266 handset
- 5111 – SV9100 IP Phone Lic, one for each ML440 handset
- DAP Controller PC
- DAP Controller Site License
- 0411 – SV9100 Version Lic (R1)
- 0300 – SV9100 Resource Lic
- 5103 – SV9100 IP Resource Lic
- 5111 – SV9100 IP Phone Lic

### Related Features

- ➔ [Call Appearance \(CAP\) Keys](#)
- ➔ [Call Forwarding](#)
- ➔ [Intercom](#)
- ➔ [IP Multiline Station \(SIP\)](#)
- ➔ [IP Single Line Telephone \(SIP\)](#)
- ➔ [Softkeys](#)
- ➔ [UM8000 Mail](#)
- ➔ [InMail](#)

### Guide to Feature Programming

The **Level 1**, **Level 2** and **Level 3** columns indicate the programs that are assigned when programming this feature in the order they are most commonly used. These levels are used with PCPro and WebPro wizards for feature programming.

- Level 1 – these are the most commonly assigned programs for this feature.
- Level 2 – these are the next most commonly assigned programs for this feature.
- Level 3 – these programs are not often assigned and require an expert level working knowledge of the system to be properly assigned.

Program Number	Program Name/Description	Input Data	Default	Level		
				1	2	3
10-12-01	<b>GCD-CP10 Network Setup – IP Address</b> Assign the IP Address.	0.0.0.0 ~ 126.255.255.254 128.0.0.1 ~ 191.255.255.254 192.0.0.1 ~ 223.255.255.254	192.168.0.10		✓	
10-12-03	<b>GCD-CP10 Network Setup – Default Gateway</b> Assign the default gateway IP address for the GCD-CP10.	0.0.0.0 ~ 126.255.255.254 128.0.0.1 ~ 191.255.255.254 192.0.0.1 ~ 223.255.255.254	0.0.0.0	✓		
10-12-09	<b>GCD-CP10 Network Setup – IP Address</b> Set IP address for GPZ-IPLE. ➡ <i>The IP Address assigned in Program 10-12-01 cannot start with the same leading digits as the IP Address assigned here.</i>	0.0.0.0 ~ 126.255.255.254 128.0.0.1 ~ 191.255.255.254 192.0.0.1 ~ 223.255.255.254	172.16.0.10	✓		
10-12-10	<b>GCD-CP10 Network Setup – Subnet Mask</b> Set the Subnet mask of the GPZ-IPLE.	128.0.0.0   192.0.0.0   224.0.0.0  240.0.0.0   248.0.0.0   252.0.0.0  254.0.0.0   255.0.0.0  255.128.0.0   255.192.0.0  255.224.0.0   255.240.0.0  255.248.0.0   255.252.0.0  255.254.0.0   255.255.0.0  255.255.128.0   255.255.192.0  255.255.224.0   255.255.240.0  255.255.248.0   255.255.252.0  255.255.254.0   255.255.255.0  255.255.255.128  255.255.255.192  255.255.255.224  255.255.255.240  255.255.255.248  255.255.255.252  255.255.255.254  255.255.255.255	255.255.0.0		✓	
10-13-01	<b>DHCP Server Mode</b> Enable/Disable the built-in DHCP Server. Enable/Disable the built-in DHCP Server.	0 = Disable 1 = Enable	0		✓	
10-13-02	<b>Lease Time</b> Lease time of the IP address to a client. Press the Transfer Key to increment to the next setting data.	Days 0 ~ 255 Hour 0 ~ 23 Minutes 0 ~ 59	0 day 0 hour 30 minutes		✓	
10-13-05	<b>Last DHCP Data</b> If 10-13-01 is enabled, this setting determines if DHCP resource is enabled or disabled.	0 = Disable 1 = Enable	1		✓	



Program Number	Program Name/Description	Input Data	Default	Level		
				1	2	3
10-54-01	<p><b>License Configuration for Each Package – License Code</b></p> <p>Assign VoIP Resource Licenses (5103) to GCD-CP10 slot (1).</p> <p>If applying more than 255 licenses to a slot, the licenses must be applied across multiple indexes.</p> <p>For example, assigning 256 VoIP resource licenses (5103) to the CPU slot could be assigned using different methods as long as the total for the CPU slot is 256.</p> <p>1. Index 1 has 128 of feature code 5103 and index 2 also has 128 of feature code 5103 for a total of 256.</p> <p>2. Index 1 has 255 of feature code 5103 and index 2 has 1 of feature code 5103 for a total of 256.</p>	1 ~ 255 Resource Licenses	0	✓		
14-02-23	<p><b>Analog Trunk Data Setup – Caller ID Receiving Method</b></p> <p>Rings extension before receiving Caller ID (1) or after receiving Caller ID (0).</p> <p>Recommended setting is 0 (Wait Caller ID).</p>	<p>0 = Wait Caller ID</p> <p>1 = Immediate Ring</p>	1		✓	
15-02-13	<p><b>Multiline Telephone Basic Data Setup – Outgoing Caller List Mode</b></p> <p>Select the type of numbers that are stored in the Redial List – Internal and External numbers (0) or External only (1).</p> <p>➡ For the ML440/G566/G266 extensions this should be set to 0.</p>	<p>0 = ICM/Trunk (Extension/Trunk Mode)</p> <p>1 = Trunk Mode</p>	1	✓		
15-02-34	<p><b>Multiline Telephone Basic Data Setup – Call Register Mode</b></p> <p>The Caller ID Scroll stores Trunk calls only (0), or both Internal and Trunk calls (1).</p> <p>➡ For the ML440/G566/G266 extensions this should be set to 1.</p>	<p>0 = Trunk Mode</p> <p>1 = Extension/Trunk Mode</p>	0	✓		
15-05-28	<p><b>IP Telephone Terminal Basic Data Setup – Addition Information Setup</b></p> <p>Determines manner in which CID id presented to an extension.</p> <p>➡ For the ML440/G566/G266 extensions this should be set to 1.</p>	<p>0 = Do not inform</p> <p>1 = Inform</p>	0	✓		
15-05-50	<p><b>IP Telephone Terminal Basic Data Setup – Peer to Peer Mode</b></p> <p>On a per station basis enable or disable Peer to Peer mode.</p>	<p>0 = Disable</p> <p>1 = Enable</p>	1	✓		

Program Number	Program Name/Description	Input Data	Default	Level		
				1	2	3
15-07-01	<p><b>Programmable Function Keys</b></p> <p>Assign functions to multiline terminal line keys. NEC recommends the following for the first three programmable keys on a ML440:</p> <p>Line Keys 1 and 2 = CAP Keys Line Key 3 = Intercom Key</p>	<p>Line Key 1 ~ 48 0 ~ 99 (Normal Function Code 751 by default) *00 ~ *99 (Appearance Function Code) (Service Code 752 by default) (*08 + XXXX = CAP key where XXXX is the CAP orbit number 0001-9999)</p>	Refer to the Programming Manual for default values.	✓		
20-02-12	<p><b>System Options for Multiline Telephones – Forced Intercom Ring (ICM Call Type)</b></p> <p>Enable/Disable Forced Intercom Ringing. If enabled, incoming Intercom calls normally ring. If disabled, Intercom calls voice-announce.</p> <p>➤ This should be set to Signal (1) or each ML440 should be set to Signal manually using dial access code 723.</p>	<p>0 = Disable (Voice) 1 = Enable (Signal)</p>	0	✓		
20-06-01	<p><b>Class of Service for Extensions</b></p> <p>Assign ML440 handsets to their own Class of Service.</p>	<p>Day Night/Mode: 1 ~ 8 Class of Service of Extensions (1 ~ 15)</p>	<p>Extension port 101 = Class 15 All other extension port = Class 1</p>	✓		
20-08-11	<p><b>Class of Service Options (Outgoing Call Service) – Protect for the Call Mode Switching from Caller</b></p> <p>Set this option for the ML440/G566/G266 handset Class of Service. When an extension is set to ring mode for ICM calls, enabling this option prevents callers from changing the call to voice announce mode.</p> <p>➤ This setting should be Enabled (1) for the ML440/G566/G266 handset Class of Service.</p>	<p>0 = Off 1 = On</p>	COS 1 ~ 15 = 0	✓		
24-09-01	<p><b>Call Forward Split Settings – Call Forwarding Type:</b></p> <p>Assign Call Forwarding Type and the destination numbers for each extension/virtual extension.</p>	<p>0 = Call Forwarding Off 1 = Call Forwarding with both ring 2 = Call Forwarding when no answer 3 = Call Forwarding all calls 4 = Call Forwarding busy or no answer 5 = Call Forwarding when busy</p>	0		✓	
24-09-02	<p><b>Call Forward Split Settings – CO Call Forwarding Destination for Both Ring, All Call, No Answer</b></p> <p>Assign CO Call Forwarding Destination for ring, all call, and no answer.</p>	<p>1 ~ 9, 0, #, *, R, @ Maximum of 24 digits</p>	No Setting		✓	

Program Number	Program Name/Description	Input Data	Default	Level		
				1	2	3
24-09-03	<b>Call Forward Split Settings - Intercom Call Forwarding Destination for Both ring, All Call, No Answer</b> Assign Intercom Call Forwarding Destination for ring, all call and no answer.	1 ~ 9, 0, #, *, R, @ Maximum of 24 digits	No Setting		✓	
24-09-04	<b>Call Forward Split Settings – CO Call Forwarding Busy Destination</b> Assign CO Call Forwarding for busy destinations.	1 ~ 9, 0, #, *, R, @ Maximum of 24 digits	No Setting		✓	
24-09-05	<b>Call Forward Split Settings – Intercom Call Forwarding Busy Destination</b> Assign Intercom Call Forwarding for busy destinations.	1 ~ 9, 0, #, *, R, @ Maximum of 24 digits	No Setting		✓	
24-09-06	<b>Call Forward Split Settings – Call Forwarding Destination for CTX/PBX for All Call, No Answer</b> Assign Call Forwarding for CTX/PBX all call, no answer destinations.	1 ~ 9, 0, #, *, R, @ Maximum of 24 digits	No Setting		✓	
24-09-07	<b>Call Forward Split Settings – Call Forwarding Destination for CTX/PBX for Busy</b> Assign Call Forwarding destinations for busy CTX/PBX calls.	1 ~ 9, 0, #, *, R, @ Maximum of 24 digits	No Setting		✓	
84-24-01	<b>DT800/DT700 Multiline CODEC Information Basic Setup – Number of G.711 Audio Frames</b> Input the amount of audio in the packets when using the G.711 Codec. ➡ <i>This should be set to 20ms (2).</i>	1 = 10ms 2 = 20ms 3 = 30ms 4 = 40ms	2		✓	
84-24-28	<b>DT800/DT700 Multiline CODEC Information Basic Setup – Audio Capability Priority</b> Set voice (RTP packet) encoding parameters. The ML440 only supports G.711.	0 = G.711_PT 2 = G.729_PT	0		✓	
84-26-01	<b>IPL Basic Setup – IP Address</b> Assign the IP address for the DSP on the GPZ-IPL.	xxx.xxx.xxx.xxx	172.16.0.20	✓		
84-26-02	<b>IPL Basic Setup – RTP Port Number</b> Assign the RTP port number to be used for each DSP on the GPZ-IPL. ➡ <i>Only even numbered ports are supported.</i>	0 ~ 65534	10020		✓	
84-26-03	<b>IPL Basic Setup – RTCP Port Number (RTP Port Number + 1)</b> Define the TCP port number for RTCP to use for each DSP.	0 ~ 65534	10021		✓	

## Operation



REFERENCE

— For specific handset information, refer to the following:

- *ML440 End User Guide*
- *G266 and G566 Handsets User Guide*

## IP Multiline Telephone (UT880)

### Description

The UT880 is a VoIP desk phone that runs the UT880 MLT Multiline Telephone Application for use on the SV9100 system. This phone is powered by Power over Ethernet (PoE) reducing the need for power adapters allowing for a clean installation. In addition, for those users who frequently make long calls the UT880 provides headset support for added comfort.

Figure 2-39 UT880 Terminal



### Powering the UT880:

The UT880 can only be powered using Power over Ethernet (PoE) 802.3af.

A PoE switch is a network switch that also provides power over the spare pairs. The switch can be used with devices other than the IP telephones and detect whether or not power is needed. Using a PoE switch makes it easier to protect the IP telephones from loss of power (connection of the PoE switch to an UPS).

### Updating the UT880 System Firmware:

UT880 firmware is updated via the Internet from the settings page of the phone. To update the firmware go to the desk top of the UT880, choose **Settings** and select **About Tablet**. Choose **System updates** then **Check now**. If an update is available you will be prompted to download the update. Once the download has finished you will be prompted to apply the update. If no update is available the phone will state your system is up to date.

## Conditions

- EHS headset functionality requires Line Key 25 to be programmed as a headset key (Program 15-07 or SC 751: 05).
- The Multiline Telephone application requires Version 1.1.0 or higher to support the built-in tablet ring tone patterns.
- The Multiline Telephone application does not support SV9100 system ring tones and patterns or downloaded ring tones.
- The Multiline Telephone application does not support multiple user accounts.
- The Multiline Telephone requires Version 1.0.14 or higher software and Program 15-05-38 set to Unicast to receive All Call or Internal pages.
- The Multiline Telephone does not support Bluetooth<sup>®</sup> connections to Apple<sup>®</sup> devices.
- The UT880 Multiline telephone Application may support (EHS) Electronic Hook Switch functionality only when a (Headset) programmable function key exists on one of the 32 programmable buttons. The on/off hook control is supported through the EHS headset device.
- The UT880 Multiline telephone application does not support Bluetooth headset functionality.
- For Electronic Hook Switch (EHS) headset functionality, only Plantronics (EHS) headsets are supported. The special EHS cable is not required or supported for use with the UT880.
- The Multiline Telephone application does not have audio path priority over third party applications. If using a third party application to play audio when a call is received, the third party application and the Multiline Telephone application will both be heard at the same time whether using the handset or speaker phone.
- When the UT880 extension is set to “Muted off-hook ringing” in Program 15-02-12, off-hook notification comes through the handset instead of the speaker phone.
- The Multiline Telephone application uses iSIP integration on SV9100.
- The Multiline Telephone application supports G.711 CODEC at 20ms only.
- The Multiline Telephone application will follow the ring no answer forward timer whenever the Multiline Telephone application is turned off or is not registered with the system.
- The UT880 DTMF payload type is fixed at 101.
- The SV9100 requires one VoIP Resource License (5103) one IP Terminal license (5111) and one Resource License (0300) per UT880 telephone.
- The UT880 can only be powered using Power over Ethernet (PoE).
- The Multiline Telephone application cannot be used on multiple voice servers at the same time.
- The UT880 does not support the Google Play™ store.
- Only the default installed applications are supported on UT880 telephones.

- The Multiline Telephone application does not support NAT Traversal.
- For outbound calls from the native Multiline Telephone application Call Log tab to function, the system must have either ARS or F-Routes configured to route the calls. If ARS or F-routes are not configured the Call Log will not store the trunk dial access code.

Table 2-61 Supported System Feature List

Feature	Supported	Comment
Abbreviated Dialing/Speed Dial	Yes	Speed dial locations can only be accessed using soft keys for outbound calls but can be stored using dial access codes.
Account Code Entry	Yes	
Account Code - Forced/Verified/Unverified	Yes	
Alarm	Yes	
Alarm Reports	N/A	
Alphanumeric Display	Yes	
Analog Communications Interface (ACI)	N/A	
Ancillary Device Connection	No	
Answer Hold	Yes	
Answer Key	Yes	
Applications	No	
Attendant Call Queuing	Yes	
Automatic Release	N/A	
Automatic Route Selection (ARS)	Yes	
Background Music	No	
Barge-In	Yes	
Call Appearance (CAP) Keys	Yes	
Call Arrival (CAR) Keys	Yes	
Call Duration Timer	Yes	
Call Forwarding	Yes	Can be programmed in 24-09-xx, through feature code from administrator desk set and from the phone using dial access codes.
Call Forwarding with Follow Me	Yes	
Call Forwarding – Centrex	Yes	
Call Forwarding – Park and Page	Yes	
Call Forwarding, All, BNA, Busy and Both Ring	Yes	
Call Forwarding, Off-Premise	Yes	
Call Forwarding/Do Not Disturb Override	Yes	

Table 2-61 Supported System Feature List (Continued)

Feature	Supported	Comment
Call Monitoring	Yes	
Call Redirect	Yes	Only ringing calls can be redirected.
Call Transfer	Yes	
Callback	Yes	
Caller ID Caller Return	Yes	
Caller ID	Yes	
Caller ID – Flexible Calling Party Number	Yes	
Call Waiting/Camp-On	Yes	
Central Office Calls, Answering	Yes	
Central Office Calls, Placing	Yes	
Class of Service	Yes	
Clock/Calendar Display	Yes	
Code Restriction	Yes	
Code Restriction Override	Yes	
Code Restriction, Dial Block	Yes	
Computer Telephony Integration (CTI) Applications	No	
Conference Calls	Yes	
Conference, Voice Call/Privacy Release	Yes	
Contact Center	No	
Cordless Telephone Connection	No	
CO Message Waiting Indication	No	
Data Line Security	Yes	
Delayed Ringing	Yes	
Department Calling	Yes	
Department Step Calling	Yes	To receive a Department Step Call the Multiline Telephone application cannot have any forwarding enabled.
Dialing Number Preview	Yes	
Dial Pad Confirmation Tone	No	
Dial Tone Detection	Yes	
Directed Call Pickup	Yes	
Directory Dialing	Yes	Cursor key operations and TELBK are not supported.
Direct Inward Dialing (DID)	Yes	
Direct Inward Line (DIL)	Yes	



Table 2-61 Supported System Feature List (Continued)

Feature	Supported	Comment
Direct Inward System Access (DISA)	N/A	The Multiline Telephone application does not support any of the built-in tablet ring tone patterns, SV9100 system ring tones or downloaded ring tones.
Direct Station Selection (DSS) Console	Yes	
Distinctive Ringing, Tones and Flash Patterns	Yes	The Multiline Telephone application requires Version 1.1.0 or higher to support the built-in tablet ring tone patterns. The Multiline Telephone application does not support SV9100 system ring tones and patterns or downloaded ring tones.
Door Box	Yes	A Door Box will ring the Multiline Telephone application and the application can call a door box but cannot activate the relay.
Do Not Disturb	Yes	
Drop Key	Yes	
E911/911	Yes	
Flash	Yes	
Flexible System Numbering	Yes	
Flexible Timeouts	Yes	
Forced Trunk Disconnect	Yes	
Group Call Pickup	Yes	
Group Listen	No	
Hands Free	Yes	
Handset Mute	Yes	
Handsfree Answerback/Forced Intercom	Yes	
Headset Operation	Yes	A headset key must be programmed on an available line key of the Multiline Telephone application to support Electronic Hook Switch functionality of EHS headsets. However, the button located on the headset itself must be used to go off/on hook. A headset key programmed on an available line key of the Multiline Telephone application must be used for Bluetooth headsets to go on hook or off hook. The button on the Bluetooth headset itself cannot be used to go off/on hook.
Hold	Yes	
Hotel/Motel	Yes	
Hotline	Yes	The Multiline Telephone application can be a hot line destination but cannot originate a hot line call.
Howler Tone Service	No	
InMail	Yes	Live Monitor is not supported.
Interactive Voice Response	N/A	
Intercom	Yes	
IP Multiline Station (SIP)	Yes	

Table 2-61 Supported System Feature List (Continued)

Feature	Supported	Comment
IP Trunk – H.323	Yes	
IP Trunk – (SIP) Session Initiation Protocol	Yes	
ISDN Compatibility	Yes	
K-CCIS – IP	Yes	If Multiline Telephone application phones are required to call across K-CCISoIP networks, peer-to-peer must be disabled in Program 15-5-50 for the Multiline Telephone application stations.
K-CCIS – T1	Yes	
Last Number Redial	Yes	
Licensing	Yes	
Line Load Control	Yes	
Line Preference	Yes	
Long Conversation Cutoff	Yes	
Meet Me Conference	Yes	Can join a Meet Me Conference but does not receive internal pages to join an internal Meet Me Conference.
Meet Me Paging	Yes	Can initiate a Meet Me Page does not receive internal pages and cannot respond to an Internal Meet Me Page.
Meet Me Paging Transfer	Yes	The Multiline Telephone application can only initiate an Internal, External or All Call Page. It cannot receive either Internal or All Call pages.
Memo Dial	Yes	
Message Waiting Indication (MWI)	Yes	
Microphone Cutoff	Yes	
Multiple Trunk Types	Yes	
Music on Hold	Yes	External callers will receive system MOH only. If the UT880 is placed on hold while calling an internal extension the UT880 will use a prerecorded MOH file.
Name Storing	Yes	
Night Service	Yes	
Off-Hook Signaling	Yes	When the UT880 extension is set to “Muted off-hook ringing” in Program 15-02-12, off-hook notification comes through the handset instead of the speaker phone.
Off-Premise Extension	No	
One-Touch Calling	Yes	
Operator	Yes	
Paging, External	Yes	The Multiline Telephone application requires Version 1.0.14 or higher software and Program 15-05-38 set to Unicast to receive All Call pages.
Paging, Internal	Yes	The Multiline Telephone application requires Version 1.0.14 or higher software and Program 15-05-38 set to Unicast to receive internal pages.

Table 2-61 Supported System Feature List (Continued)

Feature	Supported	Comment
Park	Yes	
PBX Compatibility	Yes	
PC Programming	Yes	
PC Programming – WebPro HTTPS Support	Yes	
Personal Park	Yes	
Power Failure Transfer	No	
Prime Line Selection	Yes	
Private Line	Yes	
Programmable Function Keys	Yes	
Programming from a Multiline Terminal	No	
Pulse to Tone Conversion	No	
Quick Transfer to Voice Mail	Yes	
Repeat Redial	Yes	
Reverse Voice Over	Yes	
Ringdown Extension, Internal/External	Yes	
RGA Conference	Yes	
Ring Groups	Yes	
Room Monitor	No	
Save Number Dialed	Yes	
Secondary Incoming Extension	Yes	
Secretary Call Pickup	Yes	
Secretary Call (Buzzer)	Yes	
Selectable Display Messaging	Yes	
Selectable Ring Tones	Yes	The Multiline Telephone application requires Version 1.1.0 or higher to support the built-in tablet ring tone patterns. The Multiline Telephone application does not support SV9100 system ring tones and patterns or downloaded ring tones.
Serial Call	Yes	
Simple MCU Video	No	
Single Line Telephones, Analog 500/2500 Sets	N/A	
SLT Adapter	No	
Softkeys	Yes	
Speed Dial – System/Group/Station	Yes	Speed dial locations can only be accessed using soft keys for outbound calls but can be stored using dial access codes.

Table 2-61 Supported System Feature List (Continued)

Feature	Supported	Comment
Speed Dial – Telephone Book	No	
Station Hunt	Yes	
Station Message Detail Recording	Yes	
Station Name Assignment – User Programmable	Yes	
Station Relocation	Yes	
Synchronous Ringing	No	
T1 Trunking (with ANI/DNIS Compatibility)	Yes	
Tandem Ringing	No	
Tandem Trunking (Unsupervised Conference)	Yes	
TAPI Compatibility	Yes	
Tone Override	Yes	
Transfer	Yes	
Trunk Groups	Yes	
Trunk Group Routing	Yes	
Trunk Queuing/Camp-On	Yes	
UC Suite	Yes	UC Server 1.5.0.0 is required to support the Multiline Telephone application UC Client.
UM8000	Yes	Live Monitor is not supported.
Uniform Call Distribution (UCD)	Yes	
Uniform Numbering Network	Yes	
User Programming Ability	Yes	
Video Call	No	
Virtual Extensions	Yes	
Voice Mail Integration (Analog)	Yes	
Voice Over	No	
Voice Over Internet Protocol (VoIP)	Yes	
Voice Response System (VRS) – Call Forwarding – Park and Page	Yes	

Table 2-61 Supported System Feature List (Continued)

Feature	Supported	Comment
Volume Controls	Yes	The Multiline Telephone Application does not follow SV9100 volume levels for ringing/dial tone/call. ➤ <i>Multiline Telephone Application version 1.1.1 or higher supports five local volume levels for:</i> 1) Ringing 2) Speaker Tone 3) Speaker Call 4) Handset Tone 5) Handset Call. Call volume is reset to default level on start of each call.

### Default Settings

None

### System Availability

#### Terminals

UT880

#### Required Component(s)

- GCD-CP10 with GPZ-IPLE Daughter Board installed
- 0411 – SV9100 Version Lic (R1)
- 0300 – SV9100 Resource Lic
- 5103 – SV9100 IP Resource Lic
- 5111 – SV9100 IP Phone Lic

### Related Features

- [Call Forwarding](#)
- [Intercom](#)
- [IP Multiline Station \(SIP\)](#)

## Guide to Feature Programming

The **Level 1**, **Level 2** and **Level 3** columns indicate the programs that are assigned when programming this feature in the order they are most commonly used. These levels are used with PCPro and WebPro wizards for feature programming.

- Level 1 – these are the most commonly assigned programs for this feature.
- Level 2 – these are the next most commonly assigned programs for this feature.
- Level 3 – these programs are not often assigned and require an expert level working knowledge of the system to be properly assigned.

Program Number	Program Name/Description	Input Data	Default	Level		
				1	2	3
10-12-01	<b>GCD-CP10 Network Setup – IP Address</b> Assign the IP Address.	0.0.0.0 ~ 126.255.255.254 128.0.0.1 ~ 191.255.255.254 192.0.0.1 ~ 223.255.255.254	192.168.0.10	✓		
10-12-03	<b>GCD-CP10 Network Setup – Default Gateway</b> Assign the default gateway IP address for the GCD-CP10.	0.0.0.0 ~ 126.255.255.254 128.0.0.1 ~ 191.255.255.254 192.0.0.1 ~ 223.255.255.254	0.0.0.0	✓		
10-12-09	<b>GCD-CP10 Network Setup – IP Address</b> Set IP address for GPZ-IPLE. ➡ <i>The IP Address assigned in Program 10-12-01 cannot start with the same leading digits as the IP Address assigned here.</i>	0.0.0.0 ~ 126.255.255.254 128.0.0.1 ~ 191.255.255.254 192.0.0.1 ~ 223.255.255.254	172.16.0.10	✓		
10-13-01	<b>DHCP Server Mode</b> Enable/Disable the built-in DHCP Server.	0 = Disable 1 = Enable	0			✓
10-13-02	<b>Lease Time</b> Lease time of the IP address to a client. Press the Transfer Key to increment to the next setting data.	Days 0 ~ 255 Hour 0 ~ 23	0 day 0 hour			✓
10-13-05	<b>Last DHCP Data</b> If 10-13-01 is enabled, this setting determines if DHCP resource is enabled or disabled.	0 = Disable 1 = Enable	1			✓
10-19-01	<b>VoIP DSP Resource Selection</b> Select type of GPZ-IPLE DSP Resource. This program setting has no affect on the terminal/trunk port assignment or usage.	0 = Common use for both IP extensions and trunks 1 = IP Extension 2 = SIP Trunk 3 = CCIS/Networking 4 = Use for NetLink 5 = Blocked 6 = Common without Unicast Paging 7 = Multicast Paging 8 = Unicast Paging	Resource 1 = 1 Resource 2-256 = 0		✓	

Program Number	Program Name/Description	Input Data	Default	Level		
				1	2	3
10-46-01	<p><b>DT800/DT700 Server Information Setup – Register Mode</b></p> <p>➡ <i>If the Multiline Telephone application will be using authentication, this program must be set to Automatic.</i></p> <p>Normal mode: When the phone boots up, it reports the ext. assigned in the phone or chooses the next available extension in the system. No password is required.</p> <p>Auto mode: If set to Auto, the SIP user name and password must be entered in the actual IP phone. These settings must match 84-22/15-05-27, for the phone to come on-line.</p> <p>Manual mode: When the phone boots up it prompts a user to enter a user ID and password before logging in. It checks the user ID/password against 84-22/15-05-27. If there is no match, the phone does not come on-line.</p>	<p>0 = Normal 1 = Auto 2 = Manual</p>	0		✓	
10-54-01	<p><b>License Configuration for Each Package – License Code</b></p> <p>Assign VoIP Resource Licenses (5103) to GCD-CP10 slot (1).</p> <p>If applying more than 255 licenses to a slot, the licenses must be applied across multiple indexes.</p> <p>For example, assigning 256 VoIP resource licenses (5103) to the CPU slot could be assigned using different methods as long as the total for the CPU slot is 256.</p> <p>1. Index 1 has 128 of feature code 5103 and index 2 also has 128 of feature code 5103 for a total of 256.</p> <p>2. Index 1 has 255 of feature code 5103 and index 2 has 1 of feature code 5103 for a total of 256.</p>	1 ~ 255 Resource Licenses	No Setting	✓		
15-05-27	<p><b>IP Telephone Terminal Basic Data Setup – Personal ID Index</b></p> <p>If the Multiline Telephone application is using manual/auto registration, assign each phone a unique personal index. Then go to command 84-22 to assign the user name and password.</p>	0 ~ 960	0		✓	
15-05-38	<p><b>IP Telephone Terminal Basic Data Setup – Paging Protocol Mode</b></p> <p>Sets the protocol mode for the Paging function.</p> <p>➡ <i>This must be set to Auto or Unicast to receive internal pages.</i></p> <p>➡ <i>With Version 5000 or higher, default is 1.</i></p>	<p>0 = Multicast 1 = Unicast 2 = Auto</p>	<p>0 1</p>		✓	

Program Number	Program Name/Description	Input Data	Default	Level		
				1	2	3
15-05-50	<b>IP Telephone Terminal Basic Data Setup – Peer to Peer Mode</b> On a per station basis enable or disable Peer to Peer mode.	0 = Disable 1 = Enable	1		✓	
15-20-01	<b>LCD Line Key Name Assignment</b> Define the Line Key Name for line keys on the Multiline Telephone application.	Maximum of eight digits. Maximum of 13 characters. Key Number: 01 ~ 16 (for 16LD TEL) 17 ~ 32 (for 16LD ADM)	LK01 CO001 : : LK08 CO008 LK09 All Blank : : LK48 All Blank		✓	
20-06-01	<b>Class of Service for Extensions</b> Assign Multiline Telephone application handsets to their own Class of Service.	Day Night/Mode: 1 ~ 8 Class of Service of Extensions (1 ~ 15)	Extension port 101 = Class 15 All other extension port = Class 1	✓		
24-09-01	<b>Call Forward Split Settings – Call Forwarding Type:</b> Assign Call Forwarding Type and the destination numbers for each extension/virtual extension.	0 = Call Forwarding Off 1 = Call Forwarding with both ring 2 = Call Forwarding when no answer 3 = Call Forwarding all calls 4 = Call Forwarding busy or no answer 5 = Call Forwarding when busy	0		✓	
24-09-02	<b>Call Forward Split Settings – CO Call Forwarding Destination for Both Ring, All Call, No Answer</b> Assign CO Call Forwarding Destination for ring, all call, and no answer.	1 ~ 9, 0, #, *, R, @ Maximum of 24 digits	No Setting		✓	
24-09-03	<b>Call Forward Split Settings – Intercom Call Forwarding Destination for Both ring, All Call, No Answer</b> Assign Intercom Call Forwarding Destination for ring, all call and no answer.	1 ~ 9, 0, #, *, R, @ Maximum of 24 digits	No Setting		✓	
24-09-04	<b>Call Forward Split Settings – CO Call Forwarding Busy Destination</b> Assign CO Call Forwarding for busy destinations.	1 ~ 9, 0, #, *, R, @ Maximum of 24 digits	No Setting		✓	
24-09-05	<b>Call Forward Split Settings – Intercom Call Forwarding Busy Destination</b> Assign Intercom Call Forwarding for busy destinations.	1 ~ 9, 0, #, *, R, @ Maximum of 24 digits	No Setting		✓	
24-09-06	<b>Call Forward Split Settings – Call Forwarding Destination for CTX/PBX for All Call, No Answer</b> Assign Call Forwarding for CTX/PBX all call, no answer destinations.	1 ~ 9, 0, #, *, R, @ Maximum of 24 digits	No Setting		✓	



Program Number	Program Name/Description	Input Data	Default	Level		
				1	2	3
24-09-07	<b>Call Forward Split Settings – Call Forwarding Destination for CTX/PBX for Busy</b> Assign Call Forwarding destinations for busy CTX/PBX calls.	1 ~ 9, 0, #, *, R, @ Maximum of 24 digits	No Setting		✓	
84-19-28	<b>SIP Extension CODEC Information Basic Setup – Audio Capability Priority</b> Set voice (RTP packet) encoding parameters. The Multiline Telephone application supports G.711 only.	0 = G.711_PT 2 = G.729_PT 3 = G.722 4 = G.726 5 = Not Used	0			✓
84-22-01	<b>DT800/DT700 Multiline Logon Information Setup – User ID</b> Input the User ID for each Personal ID Index (1-960) when using auto or manual registration in 10-46-01. ➡ <i>IP multiline terminals only support numerical user IDs, not alphanumeric.</i>	Maximum of 32 characters	No Setting		✓	
84-26-01	<b>IPL Basic Setup – IP Address</b> Assign the IP address for the DSP on the GPZ-IPLE.	xxx.xxx.xxx.xxx	172.16.0.20	✓		
84-26-02	<b>IPL Basic Setup – RTP Port Number</b> Assign the RTP port number to be used for each DSP on the GPZ-IPLE. ➡ <i>Only even numbered ports are supported.</i>	0 ~ 65534	10020			✓
84-26-03	<b>IPL Basic Setup – RTCP Port Number (RTP Port Number + 1)</b> Define the TCP port number for RTCP to use for each DSP.	0 ~ 65534	10021			✓

## Operation



REFERENCE

Refer to the *UT880 Owners Guide* for additional information.

## *IP Single Line Telephone (SIP)*

### Description

SIP (Session Initiation Protocol) is used for Voice over Internet Protocol. It is defined by the IETF (Internet Engineering Task Force) RFC3261. Other RFC designations, such as RFC3842, refer to a later implementation of SIP and may be supported by the UNIVERGE SV9100. Commonly called SIP Station, this feature is used for IP Stations using SIP.

SIP analyzes requests from clients and retrieves responses from servers, then sets call parameters at either end of the communication, handles call transfer, and terminates. Typically, such features, including but not limited to Voice over IP services, are available from an SIP service provider.

Depending on licensing, each GPZ-IPLE application can support a maximum of 256 TDM Talk paths. This total may be shared among SIP Stations or SIP Trunks. Registered SIP Stations and/or SIP Trunks require a one-to-one relation with the GPZ-IPLE DSP Resource. This is a required component of SIP implementation in the SV9100.

The UNIVERGE SV9100 GCD-CP10 contains a regular TCP/RTP/IP stack that can handle real-time media, support industry standard SIP (RFC 3261) communication on the WAN side, and interface with the GPZ-IPLE.

SIP IP Stations use the GPZ-IPLE. The GPZ-IPLE controls and interprets RTP messaging from the SIP IP Phone to the UNIVERGE SV9100 GCD-CP10.

The GPZ-IPLE supports only those Codecs that are considered to provide toll-quality equivalent speech path. The following voice compression methods are supported for the IP Station SIP feature:

- G.711  $\mu$ -Law – Highest Bandwidth
- G.722 – Wideband
- G.729 – Mid-Range Bandwidth

For the minimum bandwidth requirements for each voice call refer to [Table 2-62 Minimum Bandwidth Requirements](#). This includes all the overhead of VoIP communication, including signaling).

*Table 2-62 Minimum Bandwidth Requirements*

Codec	Transmit Data Rate	Receive Data Rate	Time Between Packets	Packetization Delay	Default Jitter Buffer Delay	Theoretical Maximum MOS
G.711 $\mu$ -Law	90Kbps	90Kbps	20ms*	1.5ms	2 datagrams (40ms)	4.4
G.722	64Kbps	64Kbps	20ms*	1ms	2 datagrams (40ms)	4.5
G.729	34Kbps	34Kbps	20ms*	15.0ms	2 datagrams (40ms)	4.07

- ❑ The GPZ-IPLE contains a regular TCP/RTP/IP stack that can handle real time media. The GPZ-IPLE daughter board is an end-point on the IP network from the network administration perspective.
- ❑ The GCD-CP10 uses SIP Protocol to provide telephony services between remote stations through the IP Network. This is an IETF/ITU standards-based protocol.
- ❑ Speech-connection audio quality depends greatly on the available bandwidth between the stations in the data network. Because Internet is an uncontrolled data network compared to an Intranet, using this application in Intranet WAN environment with known (or controlled and assured) Quality of Service (QoS) is highly recommended.
- ❑ An on-board RJ-45 connector provides a WAN/LAN connection. Voice and signaling data to/from the IP Stations are converted into IP Frames and transmitted through the Data Communication IP Network.
- ❑ The GPZ-IPLE supports a maximum of 256 VoIP connections
- ❑ Duplex mode (Auto or Full) and speed (10, 100 Mbps or 1 Gbps) are configured via SV9100 chassis programming.
  - ◇ *The IPLE does not support half duplex, only full duplex is supported.*
- ❑ UNIVERGE SV9100 supports a 100 rel option and Session Timer option.
- ❑ UNIVERGE SV9100 supports Early Media.
- ❑ UNIVERGE SV9100 SIP restricts an outgoing call under the following conditions:
  - ◇ *SIP configuration failed*
  - ◇ *SIP registration failed*
  - ◇ *GCD-CP10 Link down*
  - ◇ *Lack of GPZ-IPLE resource*
- ❑ Both the signaling and voice ports can be configured in the SV9100. This change only affects the packets from the SV9100 to the IP Phone. A change must be made in the IP phone to affect the packets from the IP Phone to the SV9100.
- ❑ ToS Support.

### Enhancements

- With **Version 2000 (2.00 or higher)**, Conference is supported on Standard SIP terminals.

### Conditions

- Documentation for Polycom devices are available at <http://www.polycom.com/voicedocumentation>.

- By default Polycom devices use # to initiate dialing. Therefore, # cannot be used in a dial string without a configuration change to the Polycom device. For example, dialing the default Park access code #6 will not work from a Polycom device because it starts dialing after the #, ignoring everything after. In this case, either the Park access code must be changed to not include a #, or the Remove End-Of-Dial Marker option must be disabled in the Polycom SIP Configuration Local Settings.
- SIP Stations which support RFC 3842 (Message Waiting) receive Message Waiting Lamp indications.
- Video Codecs H.264, H.263, and H.261 are supported.
- Video is supported when P2P for standard SIP is turned on. (Program 15-05-50 SIP Peer to Peer Mode ON)
- Auto start video when call is answered is not supported.
- Standard SIP video Codecs are not supported across CCIS.
- Standard SIP video Codecs are not supported across NetLink.
- Standard SIP terminal can not negotiate video Codec with Softphone.
- SIP protocol (RFC3261) is used.
- SIP Station uses the GPZ-IPLE as a media gateway.
- Default UDP listen port for a SIP station is 5070.
- UNIVERGE SV9100 Station registration policy supports an authentication feature. Enabling this policy prevents the registered telephone from unexpected override.
- UNIVERGE SV9100 supports HOLD and TRF feature on the basis of IETF draft.
  - ❑ draft-ietf-sipping-service-examples-09.txt
  - ❑ Section 2.5 (Transfer - Attended) of draft-ietf-sipping-service-examples-15.txt
  - ❑ draft-ietf-sip-session-timer-10.txt
- **When all VoIP DSP resources are busy, the SIP phone cannot preempt active calls to make a 911 call.**
- The UNIVERGE SV9100 GCD-CP10 is the registration server for the SIP stations. The configurable IP Address is located in Program 10-12-09 (SV9100 Network Setup – IP Address).
- T.38 (Fax) is supported for 3rd Party SIP “IP Single Line Telephone (SIP)” station ports.
- Program 15-03-03 must be set to 1 (Special) at the receiving terminal in order for T.38 to function.
- With SV9100 system software and GPZ-IPLE daughter board installed, half duplex connections are not supported. For troubleshooting purposes, a managed switch capable of port mirroring is required to capture packet data from the SV9100 IPLE Ethernet port.
- When using 3rd party SIP stations, the SIP server name can not contain a parenthesis.

- When out of band DTMF is used (via RFC2833), the GPZ-IPLE supports a payload of 96 ~ 127.
- If a user on a standard SIP phone is talking to another station using Voice Announce (the receiving station has not pressed speaker or lifted the handset) and the SIP phone user presses transfer or hold, the call is terminated. A standard SIP call cannot be placed on hold or transferred until the other party answers.
- The Exclusive Hold Recall Timer is used when an internal call from a 3rd Party SIP telephone is placed on hold.
- The system has the ability to receive DTMF information in SIP INFO messages sent by Standard SIP terminals. This allows the SIP Terminal to initiate features during a ringing state such as Camp-On and Message Waiting. SIP terminals must be able to support this feature and have it enabled.
- If Program 15-05-49 is set to **1: Allowed any time**, SIP INFO is received upon arrival.
- If Program 15-05-49 is set to **2: Allowed while RTP is not available**, SIP INFO is received while RTP is not established. An In-band method such as RFC2833 is used once the voice path is established.
- SIP INFO functions independently from other DTMF methods such as RFC2833. This means SIP terminals should send DTMF information by a single method, otherwise the system will receive both separately causing double digits.
- NAT or NAPT is only supported on the DT800/DT700 series phones. NAT or NAPT is not supported on the ML440, the Wireless DECT (SIP), or Softphone phones.
- The SV9100 supports NAT for Standard SIP terminals.

Table 2-63 Feature Support Table for Standard SIP Device

Feature Name	Standard SIP	Comments
Account Code - Forced/Verified/Unverified	Yes	Depending on SIP device the account code may have to be part of the dial string.
Account Code Entry	Yes	
Alarm	No	
Alarm Reports	No	
Alphanumeric Display	Yes	Some SIP devices have Alphanumeric Displays and are backlit. However, the display is not updated with CPU messages.
Analog Communications Interface (ACI)	No	
Ancillary Device Connection	No	
Answer Hold	No	
Answer Key	No	
Attendant Call Queuing	No	
Automatic Release	Yes	

Table 2-63 Feature Support Table for Standard SIP Device (Continued)

Feature Name	Standard SIP	Comments
Automatic Route Selection (ARS)	Yes	
Background Music	No	
Barge-In	Yes	
Call Appearance (CAP) Keys	No	
Call Arrival (CAR) Keys	No	
Call Duration Timer	No	Call Duration timer is a function of the client device and is not the system timer.
Call Forwarding – Centrex	Yes	
Call Forwarding	Yes	Can be programmed in 24-09-xx, through feature code from administrator desk set and from the SIP device using dial access codes. In some cases Call Forwarding can be set on SIP device itself but this not system side forwarding.
Call Forwarding with Follow Me	No	
Call Forwarding – Park and Page	No	
Call Forwarding, Off-Premise	Yes	Can be programmed in 24-09-xx, through feature code from administrator desk set and in some cases from the SIP device using dial access codes.
Call Forwarding/Do Not Disturb Override	Yes	
Call Monitoring	No	
Call Redirect	No	
Call Waiting/Camp-On	No	
Callback	Yes	
Caller ID Caller Return	Yes	Caller ID Call Return is a SIP device feature not a system feature.
Caller ID	Yes	Caller ID is shown only on ISDN, SIP or Analog CO trunks that are directed at the SIP device. Caller ID will not display for calls transferred to the SIP device.
Call Transfer	Yes	Only Announce/Supervised transfer is supported.
Central Office Calls, Answering	Yes	
Central Office Calls, Placing	Yes	
Class of Service	Yes	
Clock/Calendar Display	No	
CO Message Waiting Indication	No	
Code Restriction	Yes	
Code Restriction Override	No	
Code Restriction, Dial Block	Yes	

Table 2-63 Feature Support Table for Standard SIP Device (Continued)

Feature Name	Standard SIP	Comments
Computer Telephony Integration (CTI) Applications	No	
Conference	Yes	Version 2000 (2.00 or higher) required.
Conference, Voice Call/Privacy Release	No	
Contact Center	No	
Cordless Telephone Connection	No	
Data Line Security	Yes	
Delayed Ringing	No	
Department Calling	Yes	
Department Step Calling	Yes	
Department Group All Ring	Yes	
Dial Pad Confirmation Tone	No	
Dial Tone Detection	No	
Dialing Number Preview	Yes	
Direct Inward Dialing (DID)	Yes	
Direct Inward Line (DIL)	Yes	
Direct Inward System Access (DISA)	No	
Direct Station Selection (DSS) Console	No	
Directed Call Pickup	Yes	
Directory Dialing	No	
Distinctive Ringing, Tones and Flash Patterns	No	
Do Not Disturb	Yes	Do Not Disturb (DND) can be set from the SIP device using dial access codes. In some cases Do Not Disturb can be set via the SIP device but is not system side DND.
Do Not Disturb/Call Forward Override	Yes	
Door Box	Yes	Door Box will not ring a SIP device. A SIP device can call a door box but cannot activate the relay.
Drop Key	No	
<i>D<sup>term</sup></i> Handset Cordless	No	
<i>D<sup>term</sup></i> IP Gateway System	No	
E-911 Compatibility	No	
Electra Elite Terminal Migration	No	
Facsimile CO Branch Connection	No	
Flash	No	

Table 2-63 Feature Support Table for Standard SIP Device (Continued)

Feature Name	Standard SIP	Comments
Flexible System Numbering	Yes	
Flexible Timeouts	Yes	
Forced Trunk Disconnect	No	
Group Call Pickup	Yes	
Group Listen	No	
Handset Mute	Yes	Handset mute is a function of the SIP device.
Handset Operation	Yes	
Handsfree and Monitor	Yes	Handsfree is a feature of the SIP device.
Handsfree Answerback/Forced Intercom Ringing	No	
Hold	Yes	
Hotel/Motel	No	
Hotline	Yes	A SIP device can be a hotline destination, but cannot originate a hotline call.
Howler Tone Service	No	
InMail	Yes	
Intercom	Yes	
IP Multiline Station (SIP)	No	
IP Trunk – (SIP) Session Initiation Protocol	Yes	
IP Trunk – H.323	No	
ISDN Compatibility	Yes	
K-CCIS – IP	Yes	
K-CCIS – T1	Yes	
Last Number Redial	No	
Line Preference	No	
Long Conversation Cutoff	Yes	
Meet Me Conference	No	
Meet Me Paging	Yes	
Meet Me Paging Transfer	Yes	A SIP device can receive a Meet Me Paging Transfer but it cannot originate a Meet Me Paging transfer call.
Memo Dial	No	
Message Waiting	No	
Message Waiting Answer	Yes	
Microphone Cutoff	Yes	Microphone Cutoff is a function of the SIP device.



Table 2-63 Feature Support Table for Standard SIP Device (Continued)

Feature Name	Standard SIP	Comments
Multiple Trunk Types	Yes	
Music on Hold	Yes	
NetLink	Yes	
Name Storing	No	
NEC Interactive Voice Response	No	
Night Service	No	
Off-Hook Signaling	No	
Off-Hook Signaling Override	Yes	
One-Touch Calling	No	
Operator	Yes	
(OPX) Off-Premise Extension	No	
Paging, External	Yes	A SIP device can only initiate an Internal, External or All Call Page. It cannot receive either Internal or All Call pages or display page information.
Paging, Internal	Yes	A SIP device can only initiate an Internal, External or All Call Page. It cannot receive either Internal or All Call pages or display page information.
Park	No	
PBX Compatibility	Yes	
PC Programming	Yes	
Power Failure Transfer	No	
Prime Line Selection	Yes	Prime Line Selection can be assigned for Standard SIP devices, however when this is done the telephones cannot access ICM dial tone.
Private Line	Yes	
Programmable Function Keys	No	
Programming from a Multiline Terminal	No	
Pulse to Tone Conversion	No	
Quick Transfer to Voice Mail	Yes	Multiline Telephones can Quick Transfer to a SIP device's mailbox, but a SIP device cannot execute Quick Transfer.
Redial Function	No	Call Redial Function is a function of the client device and not the system.
Repeat Redial	No	
Reverse Voice Over	No	
Ring Groups	Yes	
Ringdown Extension, Internal/External	Yes	A SIP device can be a ring down destination but cannot originate a ring down call.

Table 2-63 Feature Support Table for Standard SIP Device (Continued)

Feature Name	Standard SIP	Comments
Room Monitor	No	
Save Number Dialed	No	
Secondary Incoming Extension	No	
Secretary Call (Buzzer)	No	
Secretary Call Pickup	No	
Selectable Display Messaging	No	
Selectable Ring Tones	Yes	Selectable Ring Tones is a function of the client device.
Serial Call	No	
Single Line Telephones, Analog 500/2500 Sets	No	
Softkeys	No	
Speed Dial - System/Group/Station	No	
Station Hunt	No	
Station Message Detail Recording	Yes	
Station Name Assignment – User Programmable	No	
Station Relocation	No	
SV9100 Communications Analyst Enterprise	Yes	
SV9100 PoE Gigabit Switch	No	
SV9100 UC Suite	No	
SV9100 Terminals	No	
Synchronous Ringing	No	
T1 Trunking (with ANI/DNIS Compatibility)	Yes	
Tandem Ringing	No	
Tandem Trunking (Unsupervised Conference)		
TAPI Compatibility	No	
Tone Override	No	
Traffic Reports	No	
Transfer	Yes	Transferred calls cannot be pulled back once transfer is initiated.
Trunk Group Routing	Yes	
Trunk Groups	Yes	
Trunk Queuing/Camp-On		
Uniform Call Distribution (UCD)	No	
Uniform Numbering Network	Yes	

Table 2-63 Feature Support Table for Standard SIP Device (Continued)

Feature Name	Standard SIP	Comments
UM8000	Yes	
User Programming Ability		
Virtual Extensions	No	Limited user customization available.
Voice Call & Signal Switching	Yes	Can only send voice/signal switch.
Voice Mail Integration (Analog)	Yes	
Voice Over	No	
Voice Over Internet Protocol (VoIP)	Yes	By nature, this is a SIP device.
Voice Response System (VRS) – Call Forwarding – Park and Page	Yes	
Volume Controls	Yes	Volume control is a function of the client device.
Wireless – DECT	No	

### Default Setting

None

## System Availability

### Terminals

SIP Terminals Compliant with RFC 3261, RFC 3262, RFC 3264 (Session Description Protocol), RFC 1889 (Real Time Protocol).

### Required Components

- GCD-CP10
- GPZ-IPLE
- 0411 – SV9100 Version Lic (R1)
- 0300 – SV9100 Resource Lic
- 5103 – SV9100 IP Resource Lic
- 5111 – SV9100 IP Phone Lic

## Related Features

None

## STD SIP – TCP Connection Support

### Description

With Version 3000 CPU software or higher, the SV9100 supports TCP connection of standard SIP telephones.

#### Conditions

- If Request Header & Contact Header in REGISTER request contains transport=tcp then the SV9100 uses TCP protocol and Program 15-05-51 is set to 1 (TCP).
- If Request Header & Contact Header in REGISTER request contains transport=udp or the Register request does not contain transport information, the SV9100 uses UDP protocol and Program 15-05-51 is set to 0 (UDP).
- The SV9100 supports STD SIP terminals without Registration. In this case the transport protocol should to be set in Program 15-24-04.
- The SV9100 supports SIP Terminals with both transport protocols (UDP & TCP) at the same time.
- If the SV9100 doesn't receive the transport protocol information (e.g. system data broken) the transport protocol is set as UDP.

#### Limitations

- When the SV9100 uses SIP terminals with TCP Protocol via NAT, the router must be set to Static NAPT mapping.

#### Default Settings

None

### System Availability

#### Terminals

ST450

Polycom VVX500

Polycom VVX600

Polycom VVX1500

## Required Components

GPZ-IPLE

0413 – SV9100 Version Lic (R3)

## STD SIP – TLS Connection Support

### Description

With Version 6000 or higher, TLS protocol is supported on STD SIP terminals. The SIP message encryption acts only between “SV9100 and STD SIP terminals”.

By default, the TLS Registrar/Proxy Port in Program 84-20-07 is set to 0. To register a STD SIP terminal using TLS it is necessary to assign the TLS Registrar/Proxy Port.

Figure 2-40 TLS Configuration

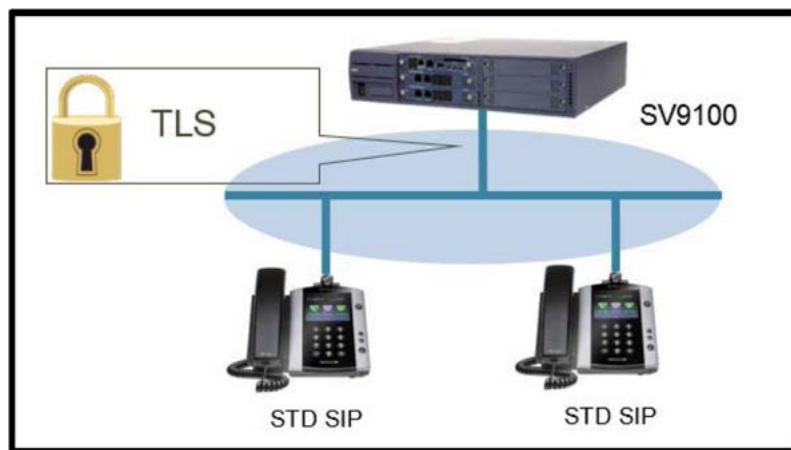
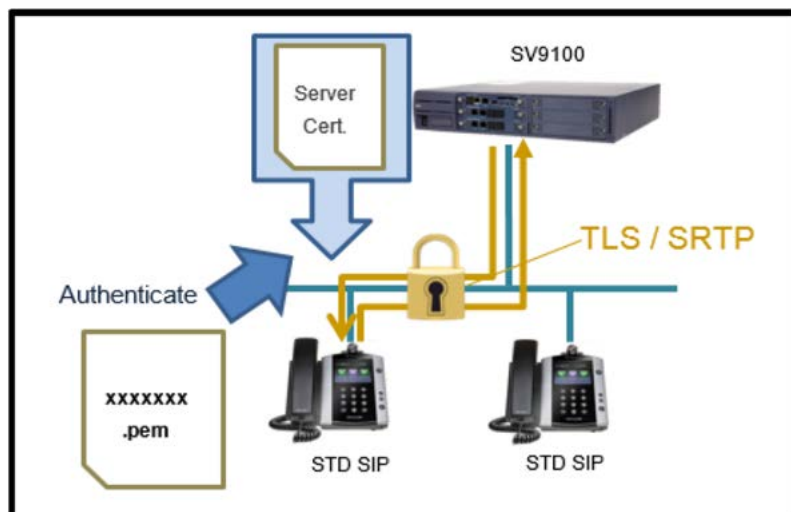

Figure 2-41 SV9100 Authentication



## Conditions

- NAT Traversal is supported.
- For a TLS connection, uMobility sends REGISTER request to port set in uMobility +1.
- The TLS STD SIP terminals do not support P2P call even if P2P settings are programmed.
- This feature does not support the terminals which do not use REGISTER method (Program 15-24-04).
- A real Encryption License (0030) is required as it is not included in Free License.
- In case of NetLink, STD SIP terminal is registered only on Primary system using TLS.

## TLS Support

- The SIP signaling packets between SV9100 and TLS STD SIP terminals are encrypted.
- The TLS connection is disconnected in the following cases:
  - Reset of SV9100
  - Restart of STD SIP terminal
  - Network Disconnection

## SV9100 Certificate and Private Key

- Registered certificate on SV9100 is used when SV9100 receives a request for TLS connection.
- If no certificate file name is set in Program 10-72 then SV9100 uses self-signed certificate for TLS connection.
- Only the certificate consisting of "PEM format" is supported. The extension of certificate file is ".pem" or ".PEM" and the extension of private key file is ".key" or ".KEY".
- The file name can consist of a maximum of 32 characters including the extension.
- The SV9100 system retains certificate files even after system restart.
- The certificates can be checked, added and deleted by WebPro under "Certificate Registration".
- Only MF level or IN level User can use "Certificate Registration" on WebPro.
- "Certificate Registration" is not displayed when SA level or UA level user logs in.
- If server certificate and private key file name set in Program 10-72 are not registered with SV9100, the STD SIP cannot be registered using TLS.
- If the private key file name set in Program 10-72-02 is invalid, the STD SIP cannot be registered using TLS.

- The import of CA certificate on different terminal are explained in the following table:

Table 2-64 Import CA Certificate Requirements

Terminal	Certificate Format	Certificate Import Method
Polycom	<ul style="list-style-type: none"> <li>○ Format PEM</li> <li>○ Extension .pem or .crt</li> </ul>	A certificate is downloaded from a file server (FTP, TFTP and Web Server) and the certificate is imported.
uMobility (iOS)	<ul style="list-style-type: none"> <li>○ Format PEM</li> <li>○ Extension .pem or .crt</li> </ul>	<ul style="list-style-type: none"> <li>○ A certificate is attached to a mail and the certificate of attached file is imported.</li> </ul>
uMobility (Android)	<ul style="list-style-type: none"> <li>○ Format PEM</li> <li>○ Extension .crt</li> </ul>	<ul style="list-style-type: none"> <li>○ A link of a certificate file is chosen from a web browser and the certificate is imported.</li> <li>○ uMobility Android only - Its possible to import a certificate from microSD.</li> </ul>

- The conditions of a TLS connection:

Table 2-65 TLS Certificate Conditions

Terminal	CA Certificate of a Terminal	Note
Polycom	<ul style="list-style-type: none"> <li>○ A valid and relevant CA Certificate should be used.</li> </ul>	If Domain Name is used for CN in a certificate then DNS server is required.
uMobility (Android) uMobility (iOS)		



*The CA Certificate set in uMobility does not authenticate the server certificate.*

NOTE

### SRTP Support

- uMobility (Android and iOS) does not support SRTP.
- If SRTP is enabled (Program 84-27-03), uMobility (Android) using TLS cannot be used.
- The uMobility terminal (Android) cannot receive a call with only encrypt voice packets.
- Voice Encryption acts between SV9100 and STD SIP terminals.
- To encrypt voice packets, it is necessary to enable SRTP Mode (Program 84-27-03 “enable”).
- If SRTP mode is enabled, the VoIP resource of 256 decreases to 230. When SRTP is disabled the VoIP resources are 256.



- The behavior of SIP message encryption and voice packets encryption depend on both Program 15-05-51 and Program 84-27-03 shown below:

Table 2-66 SIP Message Encryption

Program 15-05-51 (Read Only) Transport Protocol	Program 84-27-03 SRTP Mode	Behavior
TLS	1: Enable	SIP messages and the voice packets are encrypted.
	0: Disable	SIP messages are encrypted, voice packets are not.
UDP/TCP	1: Enable	SIP messages and voice packets are not encrypted.
	0: Disable	

- When a TLS registered STD SIP terminal calls to a non TLS registered STD SIP terminal or DT700/DT800, the call will be non-P2P even if P2P settings are programmed and SRTP is enabled.
- Alarm 74 display on Multiline terminal set in program 90-50-01 are shown below:

Table 2-67 Example of Terminal Display Alarms

Error	Cause	Correction	Display (28 Characters)
License not available	Encryption license not installed.	License check passes. (When the TLS connection is reestablished or a TLS SIP call is initiated.)	<pre> 1-1 MON 0:00AM TLS ALARM(P:00) No License List Dir VMsg ↓                     </pre>
Error in Server Certificate (Program 10-72-01)	Failed to validate Server Certificate.	When SV9100 receives offer of TLS connection, after setting correct file in Program 10-72-01.	<pre> 1-1 MON 0:00AM TLS ALARM(P:00) Cert Error02 List Dir VMsg ↓                     </pre>
Error in Private Key (Program 10-72-02)	Failed to validate Private Key.	When SV9100 receives offer of TLS connection, after setting correct file in Program 10-72-01.	<pre> 1-1 MON 0:00AM TLS ALARM(P:00) Cert Error03 List Dir VMsg ↓                     </pre>

## Default Settings

None

## System Availability

### Terminals

- Polycom VVX500 (v5.5.0.20556)
- uMobility - Android (v1.5.0.31)
- uMobility - iOS (v5.1.25)

### Required Components

- GPZ-IPLE
- 0416 – SV9100 Version Lic (R6)
- 0300 – SV9100 Resource Lic

For “Certificate Registration on WebPro” refer to feature [IP Trunk – TLS Support on SIP Trunk on page 2-911](#).

### Import CA Certificate on Polycom VVX500

- The CA certificate on Polycom VVx500 can be imported using:
  - FTP Server
  - TFTP Server
  - Web Server
- Open the web management interface of the Polycom VVX500 and browse to the **Settings** -> **Network** -> **TLS** menu.
- Select the desired Application CA container and enter the URL to the certificate file using either FTP, TFTP or HTTP.
- The **Install** button should activate once a properly formatted URL is entered. Click **Install**, the device should report that the SSL certificate was successfully installed.

Figure 2-42 TLS Certificate Configuration Screen

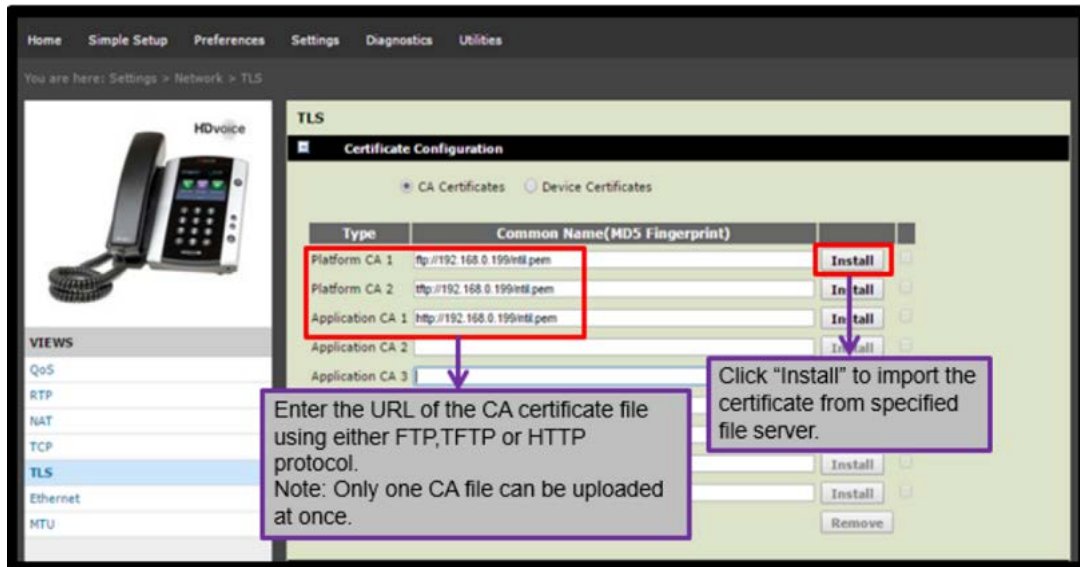

After successful import of CA certificate the following screen appears:

Figure 2-43 SSL Certificate Successfully Installed

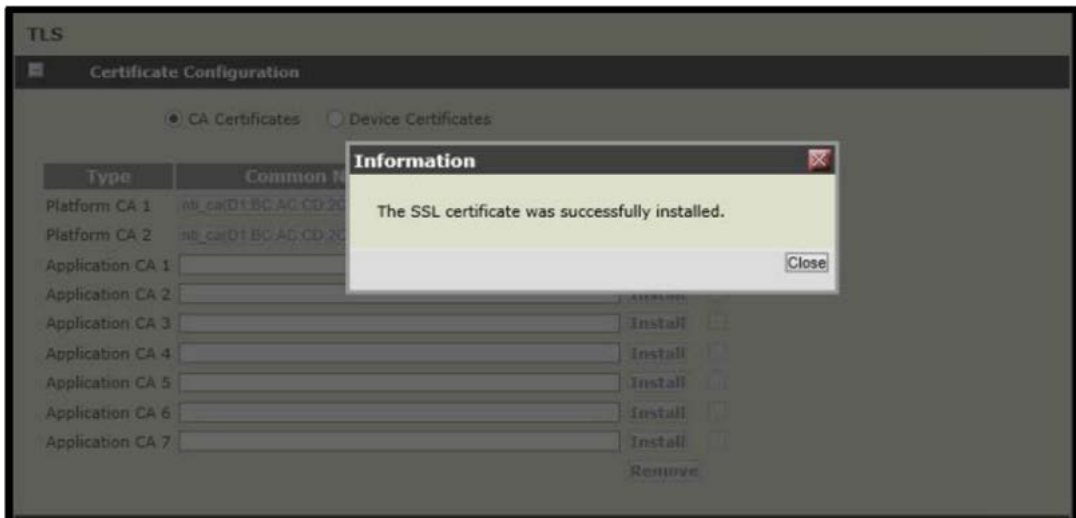

The imported certificate is displayed.

Figure 2-44 Example of Imported CA Certificates

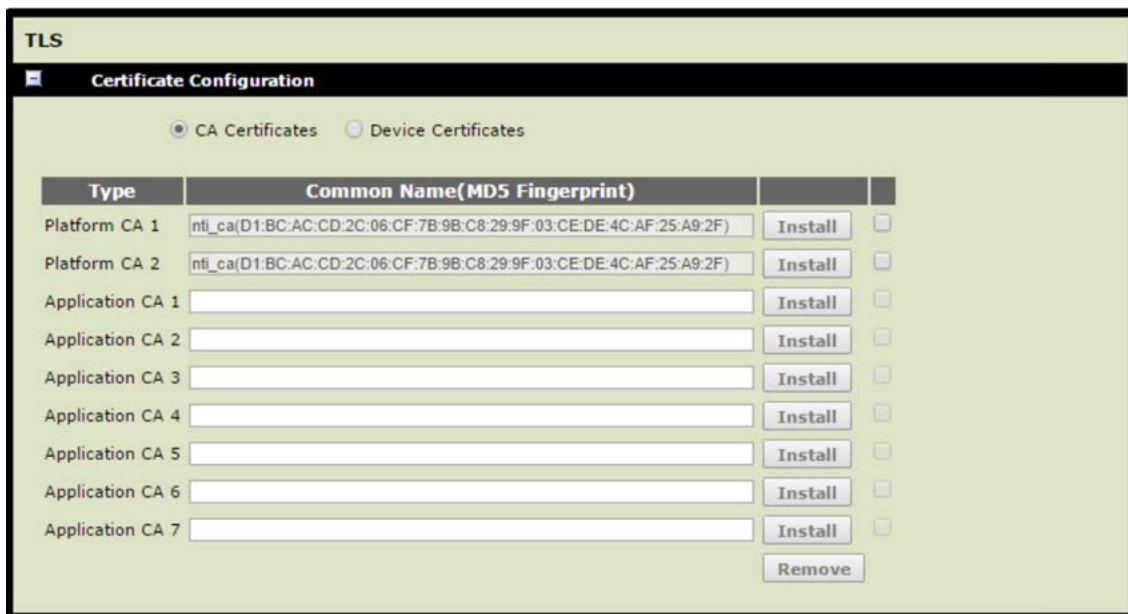

## *VoIP and CPU LAN Link – Speed and Duplex Mode*

### Description

With Version 3000 CPU software or higher, the SV9100 provides the information for the CPU and GPZ-IPLE LAN link speed and Duplex mode.

#### Conditions

- When the LAN link is active this program displays speed and Duplex mode information of the link.
- Program 90-77 data can be accessed from PCPro, WebPro and TelPro.
- PCPro can display the information once it has been downloaded from the CPU.

#### Limitations

- The LAN Link Speed of the secondary system of NET-Link is not displayed on the Primary System. This information is accessed from the WebPro of secondary system.

#### Default Settings

None

### System Availability

#### Terminals

Standard SIP Terminal

#### Required Components

GPZ-IPLE

#### Applications

- PCPro
- WebPro
- TelPro

## STD SIP Transfer-Unattended

### Description

With SV9100 software, any standard SIP terminal can perform an Unattended (Blind/Unsupervised) transfer. Refer to Section 2.4 (transfer-Unattended) of draft-ietf-sipping-service-examples-15.txt.

### Conditions

- Program15-05-50 (Peer to Peer Mode) must be disabled for the Unattended Transfer to be performed.
- A SIP terminal must receive the re-Invite message of Session Timer in a state of Unattended transfer.
- When the transfer destination terminal is busy, unanswered or the extension number in the Refer-To header is wrong or out of service, the call is sent back to the original terminal.
- If the standard SIP phone is placed on hold/park from another extension, this call cannot be transferred until the station that placed the call on hold/park retrieves the call. An unattended transfer can only be completed while both parties are in a talking state.
- The SV9100 supports both Attended and Unattended transfers.
- An unattended transfer can only be performed to the following locations:
  - Extension Number
  - Department Group Pilot Number
  - Group Pilot Number
  - Operator Access
  - Trunk/Alternate trunk access code
  - F-Route Access
  - Network Access
- Quick transfer to Voice Mail is not supported when using Unattended Transfer.

### Default Settings

None

## System Availability

### Terminals

Standard SIP Terminal

### Required Components

- GCD-CP10
- GPZ-IPLE
- 0411 – SV9100 Version Lic (R1)
- 0300 – SV9100 Resource Lic
- 5103 – SV9100 IP Resource Lic
- 5111 – SV9100 IP Phone Lic

### Related Features

- ➔ **IP Single Line Telephone (SIP)**
- ➔ **Transfer**

# STD SIP Conference

## Description

With SV9100 2.00 or higher software, Standard SIP Terminals can initiate a conference call.

Figure 2-45 Example – Standard SIP Conference

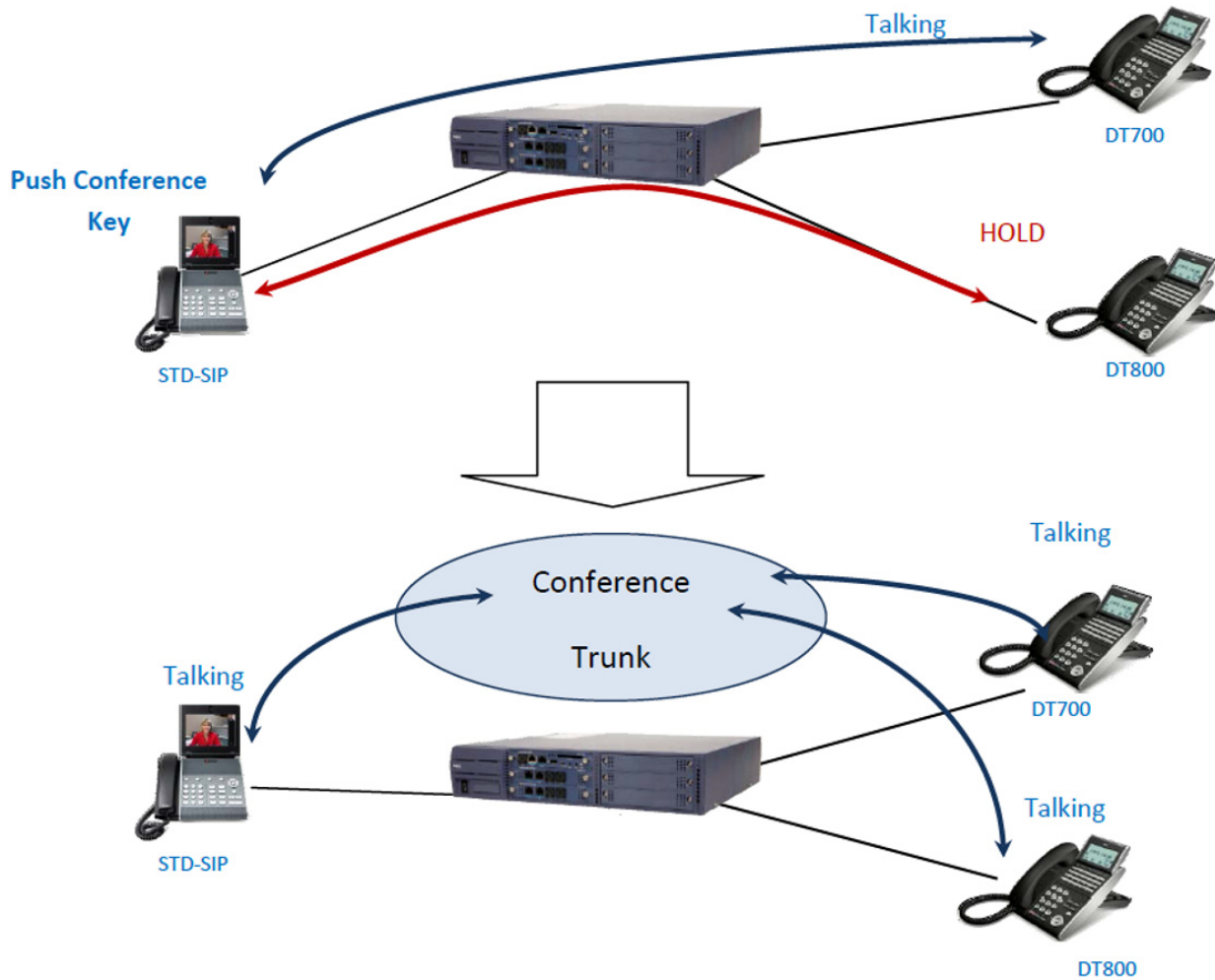

## Conditions

- Program 20-13-08 must be enabled for the Class of Service the Standard SIP Terminal is in.
- One DSP Resource is required for each Standard SIP or DT800/700 that is in the conference.



Table 2-68 Example of Conference DSP Resource Requirement

Member 1	Member 2	Member 3	Number of DSP
Std-SIP	DT400	DT400	1
Std-SIP	Std-SIP	DT300	2
Std-SIP	DT800	Std-SIP	3

- Video calls are not supported.
- The following features are not supported with Standard SIP Conference:
  - Meet Me Conference
  - Barge in to Conference
  - Split between parties in conference
  - Transfer a call into a conference

### Default Settings

None

## System Availability

### Terminals

Standard SIP Terminal

### Required Components

- GCD-CP10
- GPZ-IPLE
- 0300 – SV9100 Resource Lic
- 5103 – SV9100 IP Resource Lic
- 5111 – SV9100 IP Phone Lic

## Related Features

➔ **IP Single Line Telephone (SIP)**

➔ **Conference**

## Guide to Feature Programming

The **Level 1**, **Level 2** and **Level 3** columns indicate the programs that are assigned when programming this feature in the order they are most commonly used. These levels are used with PCPro and WebPro wizards for feature programming.

- Level 1 – these are the most commonly assigned programs for this feature.
- Level 2 – these are the next most commonly assigned programs for this feature.
- Level 3 – these programs are not often assigned and require an expert level working knowledge of the system to be properly assigned.

### VoIP Settings:

Program Number	Program Name/Description	Input Data	Default	Level		
				1	2	3
10-12-03	<b>GCD-CP10 Network Setup – Default Gateway</b> Assign the default gateway IP address for the GCD-CP10.	0.0.0.0 ~ 126.255.255.254 128.0.0.1 ~ 191.255.255.254 192.0.0.1 ~ 223.255.255.254	0.0.0.0	✓		
10-12-09	<b>GCD-CP10 Network Setup – IP Address</b> Set IP address for GPZ-IPLE. ➔ <i>The IP Address assigned in Program 10-12-01 cannot start with the same leading digits as the IP Address assigned here.</i>	0.0.0.0 ~ 126.255.255.254 128.0.0.1 ~ 191.255.255.254 192.0.0.1 ~ 223.255.255.254	172.16.0.10	✓		
10-12-10	<b>GCD-CP10 Network Setup – Subnet Mask</b> Define the Media Gateway Subnet Mask Address.	128.0.0.0   192.0.0.0   224.0.0.0  240.0.0.0   248.0.0.0   252.0.0.0  254.0.0.0   255.0.0.0  255.128.0.0   255.192.0.0  255.224.0.0   255.240.0.0  255.248.0.0   255.252.0.0  255.254.0.0   255.255.0.0  255.255.128.0   255.255.192.0  255.255.224.0   255.255.240.0  255.255.248.0   255.255.252.0  255.255.254.0   255.255.255.0  255.255.255.128  255.255.255.192  255.255.255.224  255.255.255.240  255.255.255.248  255.255.255.252  255.255.255.254  255.255.255.255	255.255.0.0		✓	

Program Number	Program Name/Description	Input Data	Default	Level		
				1	2	3
10-19-01	<p><b>VoIP DSP Resource Selection</b>                      Select type of GPZ-IPLE DSP Resource. This program setting has no affect on the terminal/trunk port assignment or usage.</p>	0 = Common use for both IP extensions and trunks 1 = IP Extension 2 = SIP Trunk 3 = CCIS/Networking 4 = Use for NetLink 5 = Blocked 6 = Common without Unicast Paging 7 = Multicast Paging 8 = Unicast Paging	Resource 1 = 1 Resource 2 ~ 256 = 0	✓		
10-54-01	<p><b>License Configuration for Each Package – License Code</b>                      Assign VoIP Resource Licenses (5103) to GCD-CP10 slot (1).                      If applying more than 255 licenses to a slot, the licenses must be applied across multiple indexes.                      For example, assigning 256 VoIP resource licenses (5103) to the CPU slot could be assigned using different methods as long as the total for the CPU slot is 256.                      1. Index 1 has 128 of feature code 5103 and index 2 also has 128 of feature code 5103 for a total of 256.                      2. Index 1 has 255 of feature code 5103 and index 2 has 1 of feature code 5103 for a total of 256.</p>	1 ~ 255 Resource Licenses	0	✓		
15-03-03	<p><b>Single Line Telephone Basic Data Setup – Terminal Type</b>                      Enter 1 for this option to allow a single line port to receive DTMF tones after the initial call setup. Enter 0 to have the port ignore DTMF tones after the initial call setup. For Voice Mail, always enter 1 (e.g., receive DTMF tones).</p>	0 = Normal 1 = Special	0	✓		
15-05-50	<p><b>IP Telephone Terminal Basic Data Setup – Peer to Peer Mode</b>                      On a per station basis enable or disable Peer to Peer mode.</p>	0 = Disable 1 = Enable	1	✓		
84-06-01	<p><b>PVA Data Setting – RTP Port Number</b>                      Define the Media Gateway starting RTP Port Number.</p>	0 ~ 65535	10020		✓	
84-06-02	<p><b>PVA Data Setting – RTCP Port Number</b>                      Define the Media Gateway Starting RTCP Port Number. The RTCP Port Number is the RTP port number + 1.</p>	RTP Port Number + 1	10021		✓	

Program Number	Program Name/Description	Input Data	Default	Level		
				1	2	3
84-06-04	<b>PVA Data Setting – Fract Lost Threshold</b> Define the fractional lost threshold – this data is sent to the UNIVERGE SV9100 GCD-CP10 when the value exceeds the defined value.	0 ~ 100%	0		✓	
84-06-05	<b>PVA Data Setting – Packets Lost Threshold</b> Define the packet lost threshold – this data is sent to the UNIVERGE SV9100 GCD-CP10 when the value exceeds the defined value.	0 ~ 16777215	0		✓	
84-06-07	<b>PVA Data Setting – Jitter Threshold</b> Define the Jitter Threshold – this data is sent to the UNIVERGE SV9100 GCD-CP10 when the value exceeds the defined value.	0 ~ 4294967295 seconds	0		✓	
84-06-09	<b>PVA Data Setting – Delay LSR Threshold</b> Define the Delay threshold – this data is sent to the UNIVERGE SV9100 GCD-CP10 when the value exceeds the defined value.	0 ~ 4294967295 seconds	0		✓	

### VoIP ToS Setup:

The UNIVERGE SV9100 supports Quality of Service (QoS) Marking for the Session Initiation Protocol (SIP).

Program Number	Program Name/Description	Input Data	Default	Level		
				1	2	3
84-10-01	<b>ToS Setup – ToS Mode</b> When Input Data is set to 1, Protocol 7 is invalid. When Data is set to 2, Protocols 2 ~ 6 are invalid.	0 = Disable (Invalid) 1 = IP Precedence 2 = Diffserv	0		✓	

### IP Extension Numbering:

Program Number	Program Name/Description	Input Data	Default	Level		
				1	2	3
11-02-01	<b>Extension Numbering</b> Define the IP Phone extension number.	Maximum of eight digits	1 101 2 102 3 103 ~ ~ 99 199 100 3101 ~ ~ 960 3961	✓		

**SIP Extension Codec Information:**

Program Number	Program Name/Description	Input Data	Default	Level		
				1	2	3
84-19-01	<b>SIP Extension CODEC Information Basic Setup – Number of G.711 Audio Frames</b> Define the G.711 audio frame size.	1 ~ 4 1 = 10ms 2 = 20ms 3 = 30ms 4 = 40ms	2		✓	
84-19-02	<b>SIP Extension CODEC Information Basic Setup – G.711 Voice Activity Detection Mode</b> Enable/ Disable Voice Activity Detection for G.711.	0 = Disable 1 = Enable	0		✓	
84-19-03	<b>SIP Extension CODEC Information Basic Setup – G.711 Type</b> Define the G.711 Type – $\mu$ -law is recommended when in USA.	0 = A-law 1 = $\mu$ -law	1		✓	
84-19-04	<b>SIP Extension CODEC Information Basic Setup – G.711 Jitter Buffer (min)</b> Define G.711 Jitter Buffer minimum accepted value.	0 ~ 300ms	20		✓	
84-19-05	<b>SIP Extension CODEC Information Basic Setup – G.711 Jitter Buffer (average)</b> Define G.711 Jitter Buffer average accepted value.	0 ~ 300ms	40		✓	
84-19-06	<b>SIP Extension CODEC Information Basic Setup – G.711 Jitter Buffer (max)</b> Define G.711 Jitter Buffer maximum accepted value.	0 ~ 300ms	80		✓	
84-19-07	<b>SIP Extension CODEC Information Basic Setup – Number of G.729 Audio Frames</b> Define the G.729 audio frame size.	1 ~ 6 1 = 10ms 2 = 20ms 3 = 30ms 4 = 40ms 5 = 50ms 6 = 60ms	2		✓	
84-19-08	<b>SIP Extension CODEC Information Basic Setup – G.729 Voice Activity Detection Mode</b> Enable/Disable Voice Activity Detection for G.729.	0 = Disable 1 = Enable	0		✓	
84-19-09	<b>SIP Extension CODEC Information Basic Setup – G.729 Jitter Buffer (min)</b> Define G.729 Jitter Buffer minimum accepted value.	0 ~ 300ms	20		✓	
84-19-10	<b>SIP Extension CODEC Information Basic Setup – G.729 Jitter Buffer (average)</b> Define G.729 Jitter Buffer average accepted value.	0 ~ 300ms	40		✓	

Program Number	Program Name/Description	Input Data	Default	Level		
				1	2	3
84-19-11	<b>SIP Extension CODEC Information Basic Setup – G.729 Jitter Buffer (max)</b> Define G.729 Jitter Buffer maximum accepted value.	0 ~ 300ms	80		✓	
84-19-17	<b>SIP Extension CODEC Information Basic Setup – Jitter Buffer Mode</b> Define the Jitter Buffer mode – supported Static or Immediate.	1 = Static 2 = Adaptive during Silence 3 = Adaptive Immediately	3		✓	
84-19-18	<b>SIP Extension CODEC Information Basic Setup – VAD Threshold</b> Define the VAD Threshold – Values set in dB. Consult the UNIVERGE SV9100 Programming Manual for Threshold scale to set acceptable values.	0 ~ 30	20		✓	
84-19-28	<b>SIP Extension CODEC Information Basic Setup – Audio Capability Priority</b> Define Audio Priority. Consult the UNIVERGE SV9100 Programming Manual for Transmit Gain scale to set acceptable value.	0 = G.711_PT 2 = G.729_PT 3 = G.722 4 = G.726	0		✓	
84-19-33	<b>SIP Extension IP CODEC Information Basic Setup – Number of G.722 Audio Frames</b> Define the number of Audio Frames for G.722 Codec.	1 ~ 4 1 = 10ms 2 = 20ms 3 = 30ms 4 = 40ms	3		✓	
84-19-34	<b>SIP Extension IP CODEC Information Basic Setup – G.722 Voice Activity Detection Mode</b> Enable/Disable G.722 Voice Activity Detection Mode.	0 = Disable 1 = Enable	0		✓	
84-19-35	<b>SIP Extension IP CODEC Information Basic Setup – G.722 Jitter Buffer (min)</b> Define the minimum setting for the G.722 Jitter Buffer.	0 ~ 300ms	30		✓	
84-19-36	<b>SIP Extension IP CODEC Information Basic Setup – G.722 Jitter Buffer (Average)</b> Define the average setting for the G.722 Jitter Buffer.	0 ~ 300ms	60		✓	
84-19-37	<b>SIP Extension IP CODEC Information Basic Setup – G.722 Jitter Buffer (Max)</b> Define the maximum setting for the G.722 Jitter Buffer.	0 ~ 300ms	120		✓	
84-19-38	<b>SIP Extension IP CODEC Information Basic Setup – Number of G.726 Audio Frames</b> Define the number of G.726 Audio Frames.	1 ~ 4 1 = 10ms 2 = 20ms 3 = 30ms 4 = 40ms	3		✓	

Program Number	Program Name/Description	Input Data	Default	Level		
				1	2	3
84-19-39	<b>SIP Extension IP CODEC Information Basic Setup – G.726 Voice Activity Detection Mode</b> Enable/Disable the G.726 Voice Activity Detection mode.	0 = Disable 1 = Enable	0		✓	
84-19-40	<b>SIP Extension IP CODEC Information Basic Setup – G.726 Jitter Buffer (min)</b> Define the minimum setting for the G.726 Jitter Buffer.	0 ~ 300ms	30		✓	
84-19-41	<b>SIP Extension IP CODEC Information Basic Setup – G.726 Jitter Buffer (Average)</b> Define the average setting for the G.726 Jitter Buffer.	0 ~ 300ms	60		✓	
84-19-42	<b>SIP Extension IP CODEC Information Basic Setup – G.726 Jitter Buffer (Max)</b> Define the maximum setting for the G.726 Jitter Buffer.	0 ~ 300ms	120		✓	
84-19-49	<b>SIP Extension IP CODEC Information Basic Setup – RTP Filter</b> To avoid incorrect voice pass connection, this Program checks the sending side address from received RTP packet at VoIPDB.	0 = Disable 1 = Enable 2 = Enable (include SSRC)	0	✓		
84-33-01	<b>FAX over IP Setup – FAX Relay Mode</b> Enable/Disable the FAX relay mode.	0 = Disable 1 = Enable 2 = Each Port Mode	0	✓		
84-33-02	<b>FAX over IP Setup – T.38 Protocol Mode</b> Sets the T.38 protocol mode.	0 = R/U 1 = U/R 2 = RTP 3 = UDPTL	1	✓		
84-33-06	<b>FAX over IP Setup – T.38 FAX Maximum Speed</b> Sets the maximum FAX rate.	0 = V.27ter, 4800bps 1 = V.29, 9600bps 2 = V.17, 14400bps	2		✓	
84-33-10	<b>FAX over IP Setup – TCF Handling Method</b> Sets the training confirmation handling mode, local denotes that the VoIP DB will generate tone and check, Network denotes that TCF is sent over the network provider.	0 = Receive TCF signal by VoIPDB 1 = Through TCF signal to external FAX	1		✓	
84-33-18	<b>FAX over IP Setup – FAX RTP Payload Type</b> Sets the payload number for T.38 RTP Format.	0, 2, 8, 96 ~ 127	103		✓	
84-34-01	<b>VoIPDB DTMF Setup – DTFMF Relay Mode</b> Define the DTMF Relay Mode for Type 4 SIP Extension.	0 = Disable 1 = RFC2833 2 = H.245	0	✓		
84-34-02	<b>VoIPDB DTMF Setup – DTMF Payload Number</b> Set DTMF Payload for standard SIP extensions.	96 ~ 127	110		✓	

**SIP Extension Basic Information Setup:**

Program Number	Program Name/Description	Input Data	Default	Level		
				1	2	3
84-20-01	<b>SIP Extension Basic Information Setup – Registrar/Proxy Port</b> Define SIP station Proxy Port.	1 ~ 65535	5070		✓	
84-20-02	<b>SIP Extension Basic Information Setup – Session Timer Value</b> Define the periodic refresh time that allows both user agents and proxies to determine if the SIP session is still active.	1 ~ 65535	180		✓	
84-20-03	<b>SIP Extension Basic Information Setup – Minimum Session Timer Value</b> Define the minimum allowed value for the SIP session timer.	1 ~ 65535	180		✓	
84-20-04	<b>SIP Extension Basic Information Setup – Called Party Info</b> Define the SIP Extension presented Caller ID information.	0 = Request URI 1 = To Header	0		✓	
84-20-05	<b>SIP Extension Basic Information Setup – Expire Value of Invite</b> Define the time out response value for SIP invite.	0 ~ 256 seconds	180		✓	
84-26-01	<b>IPL Basic Setup – IP Address</b> Assign the IP address for the DSP on the GPZ-IPLE.	xxx.xxx.xxx.xxx	172.16.0.20	✓		
84-26-02	<b>IPL Basic Setup – RTP Port Number</b> Assign the RTP port number to be used for each DSP on the GPZ-IPLE. ➡ Only even numbered ports are supported.	0 ~ 65534	10020		✓	
84-26-03	<b>IPL Basic Setup – RTCP Port Number (RTP Port Number + 1)</b> Define the TCP port number for RTCP to use for each DSP.	0 ~ 65534	10021		✓	

**IP Phone Configuration:**

Program Number	Program Name/Description	Input Data	Default	Level		
				1	2	3
15-01-01	<b>Basic Extension Data Setup – Extension Name</b> Define the extension/virtual extension name.	Maximum of 12 characters.	STA 101 = Ext 101 STA 102 = Ext 102, etc.	✓		



Program Number	Program Name/Description	Input Data	Default	Level		
				1	2	3
15-05-02	<b>IP Telephone Terminal Basic Data Setup – IP Phone Fixed Port Assignment</b> MAC Address of registered MLT SIP phone is stored and/or can input the MAC address of an MLT SIP phone so when it comes online it is provided with the extension which the MAC address matches.	MAC address 00-00-00-00-00-00 to FF-FF-FF-FF-FF-FF	00-00-00-00-00-00	✓		
15-05-07	<b>IP Telephone Terminal Basic Data Setup – Using IP Address</b> Review the registered IP Phones IP Address [Informational Only].	0.0.0.0 ~ 255.255.255.255	0.0.0.0	✓		
15-05-16	<b>IP Telephone Terminal Basic Data Setup – Authentication Password</b> Assign the authentication password for SIP single line telephones.	Maximum of 24 characters.	No Setting	✓		
15-05-18	<b>IP Telephone Terminal Basic Data Setup – IP Duplication Allowed Group</b> For an adapter that has one IP address coming into it but multiple extensions off of it. Enable this option for all extensions in the group so the CPU knows that the one IP Address is assigned to multiple extensions.	0 = Disable 1 = Enable	0	✓		
15-05-40	<b>IP Telephone Terminal Basic Data Setup – Calling Name Display Info via Trunk for Standard SIP</b> Sets the incoming calling name display type on a standard SIP terminal. Trunk name is the first priority and abbreviated (SPD) name is second priority.	0 = Both name and number 1 = Name only 2 = Number only 3 = None	0		✓	
15-05-43	<b>IP Telephone Terminal Basic Data Setup – Video Mode</b> Enable or Disable Video Mode for standard SIP terminals.	0 = Disable 1 = Enable	0		✓	
15-05-49	<b>IP Telephone Terminal Basic Data Setup – Receiving SIP INFO</b> Select whether or not system can receive DTMF from standard SIP phone via SIP INFO message.	0 = Disable 1 = Allowed any time 2 = Allowed while RTP is not available	1		✓	

**STD SIP – TCP Connection Support:**

Program Number	Program Name/Description	Input Data	Default	Level		
				1	2	3
15-05-51	<b>IP Telephone Terminal Basic Data Setup – Transport Protocol</b> Read only program that shows the transport protocol for selected SIP terminal.	0 = UDP 1 = TCP 2 = TLS	0	✓		

Program Number	Program Name/Description	Input Data	Default	Level		
				1	2	3
15-24-04	<b>Registration of Standard SIP Terminal – Transport Protocol</b> This program sets the transport protocol for selected SIP terminal without registration method.	0 = UDP 1 = TCP	0	✓		

### STD SIP – TLS Connection Support

Program Number	Program Name/Description	Input Data	Default	Level		
				1	2	3
10-72-01	<b>Network Security Setup – Server Certificate</b> Assign the Server Certificate file's name for SV9100.	Maximum of 32 characters	No Setting		✓	
10-72-02	<b>Network Security Setup – Private Key</b> Assign the Private Key file's name for SV9100.	Maximum of 32 characters	No Setting		✓	
15-05-51	<b>IP Telephone Terminal Basic Data Setup – Transport Protocol</b> Read only program that shows the transport protocol for selected SIP terminal.	0 = UDP 1 = TCP 2 = TLS	0	✓		
84-20-07	<b>SIP Extension Basic Information Setup – TLS Registrar/Proxy Port</b> Set the STD SIP port number (Receiving Transport for UNIVERGE SV9100 SIP) for TLS. ➡ When setting port number is 0, a port number does not open.	0 ~ 65535	0		✓	
90-10-01	<b>System Alarm Setup – Alarm Type</b> Set the alarm type 74. <b>Alarm 74</b> Set system alarm for TLS SIP error information.	0 = Not Set 1 = Major Alarm 2 = Minor Alarm	0		✓	

### VoIP and CPU LAN Link – Speed and Duplex Mode

Program Number	Program Name/Description	Input Data	Default	Level		
				1	2	3
90-77-01	<b>LAN Link Speed Information – LAN Link Speed of CPU</b> This program shows the speed & duplex mode of CPU LAN Link. (This is a read only program)	0 = No Link 1 = 1Gbps, Full Duplex 2 = 1Gbps, Half Duplex 3 = 100Mbps, Full Duplex 4 = 100Mbps, Half Duplex 5 = 10Mbps, Full Duplex 6 = 10Mbps, Half Duplex	0	✓		

Program Number	Program Name/Description	Input Data	Default	Level		
				1	2	3
90-77-02	<b>LAN Link Speed Information – LAN Link Speed of VoIP</b> This program shows the speed & duplex mode of VoIP DB LAN Link. (This is a read only program)	0 = No Link 1 = 1Gbps, Full Duplex 2 = 1Gbps, Half Duplex 3 = 100Mbps, Full Duplex 4 = 100Mbps, Half Duplex 5 = 10Mbps, Full Duplex 6 = 10Mbps, Half Duplex	0	✓		

**STD SIP Transfer – Unattended:**

Program Number	Program Name/Description	Input Data	Default	Level		
				1	2	3
15-05-50	<b>IP Telephone Terminal Basic Data Setup – Peer to Peer Mode</b> On a per station basis enable or disable Peer to Peer mode.	0 = Disable 1 = Enable	1	✓		

**STD SIP Conference:**

Program Number	Program Name/Description	Input Data	Default	Level		
				1	2	3
20-13-08	<b>Class of Service Options (Supplementary Service) – Conference</b> Turn On or Off an extension user ability to initiate a conference.	0 = Off 1 = On	1	✓		

### SIP Phone Example:

Figure 2-46 Example – SIP Phone

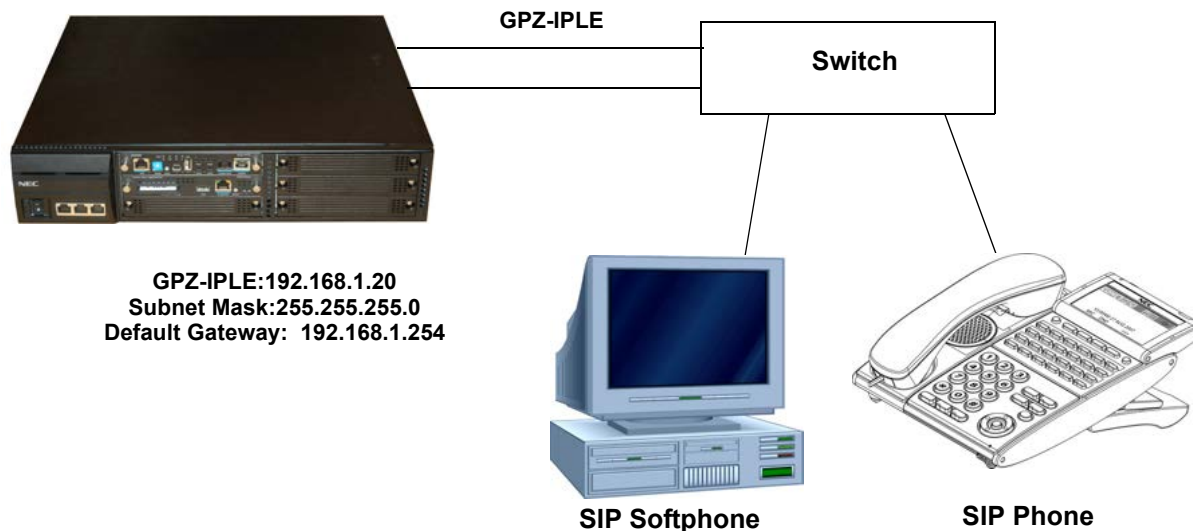

The following menu items require programming in your SIP IP Phone (consult SIP Phone vendor specific documentation):

Program/Item No.	Description/Selection	Default Assigned Data	Comments
1	IP Address	0.0.0.0	Enter a Static IP Address for the SIP Phone.
2	Subnet Mask	0.0.0.0	Enter the Subnet Mask Address.
3	Default Gateway	0.0.0.0	Enter the Default Gateway address.
4	GPZ-IPLE Address	0.0.0.0	Enter the GPZ-IPLE IP Address. ➤ This information can be located in Program 10-12-09 UNIVERGE SV9100 Network Setup IP Address.
5	Extension Number	0	Assign the SIP Phone extension. This information must match Program 11-02-01 Extension Numbering.

## Operation

### Polycom VVX 500

#### To establish a Conference:

1. Establish an intercom or trunk call.
  2. Press the **Hold** softkey to place the first call on hold.
  3. Establish a second call (intercom or trunk), which is to be added in the conference.
  4. When the called party answers, press the **Join** softkey to start the conference.
  5. Repeat steps 2-4 to add parties to the conference.
- OR -
1. Establish an intercom or trunk call.
  2. Press the **Conference** softkey to place the first call on hold.
  3. Establish a second call (intercom or trunk), which is to be added in the conference.
  4. When the called party answers, press the **Conference** softkey to start the conference.
  5. Repeat steps 2-4 to add parties to the conference.

### NEC ITX-1DE-1W

#### To establish a Conference:

1. Establish an intercom or trunk call.
2. Press the **Hold** key to place the first call on hold.
3. Establish a second call (intercom or trunk), which is to be added in the conference.
4. When the called party answers, press the **CONF** key to start the conference.
5. Repeat steps 2-4 to add parties to the conference.

## *IP Single Line Telephone (SIP) – NAT Mode*

### Description

With SV9100 system software, the SV9100 supports the NAT (Network Address Translation) mode for Standard SIP terminals.

### Conditions

- When Program 10-33-05 NAT mode for SIP phone is set to 1 (Enable), the P2P mode for SIP Phone becomes always Off regardless of Program 15-05-50 setting.
- Standard SIP Video call feature which uses P2P mode cannot be established in the same system since the P2P mode is disabled by enabling Program 10-33-05.
- SIP Station – GPZ-IPLE does not support a Blind Transfer feature.
- When connecting multiple SIP Phones via NAT, Program 15-05-18 has to be set to admit registration of multiple SIP Phones which are using the same IP address. For example, a Standard SIP terminal that has two lines registering with the same IP Address requires Program 15-05-18 to be set for both extension numbers.
- In the router/firewall that the SV9100 resides behind port forwarding is required. Port forwarding at the SIP Terminal end is not required as long as Program 15-05-45 (Plug and Play) is enabled. The ports that must be forwarded to the SV9100 are as follows:
  - UDP Port 5070 MUST be forwarded to the IP Address assigned in Program 10-12-09.
  - UDP Ports 10020 ~ 10531 (GPZ-IPLE), MUST be forwarded to the IP Address (s) assigned in Program 84-26-01.
- When Program 15-05-45 is set to “1” the manual table setting for port forwarding may not be required on the remote side router, but the router must support the NAT function itself. If Program 15-05-45 is set to “0” port forwarding at the Remote side router is required. This feature requires the installation of GPZ-IPLE.

### Default Settings

None

### System Availability

#### Terminals

Standard SIP Terminals

### Required Components

- GCD-CP10
- GPZ-IPLE
- 0411 – SV9100 Version Lic (R1)
- 0300 – SV9100 Resource Lic
- 5103 – SV9100 IP Resource Lic
- 5111 – SV9100 IP Phone Lic

### Related Features

None

### Guide to Feature Programming

The **Level 1**, **Level 2** and **Level 3** columns indicate the programs that are assigned when programming this feature in the order they are most commonly used. These levels are used with PCPro and WebPro wizards for feature programming.

- Level 1 – these are the most commonly assigned programs for this feature.
- Level 2 – these are the next most commonly assigned programs for this feature.
- Level 3 – these programs are not often assigned and require an expert level working knowledge of the system to be properly assigned.

Program Number	Program Name/Description	Input Data	Default	Level		
				1	2	3
10-12-03	<b>GCD-CP10 Network Setup – Default Gateway</b> Assign the default gateway IP address for the GCD-CP10.	0.0.0.0 ~ 126.255.255.254 128.0.0.1 ~ 191.255.255.254 192.0.0.1 ~ 223.255.255.254	0.0.0.0	✓		
10-12-07	<b>GCD-CP10 Network Setup – NAPT Router IP Address (Default Gateway [WAN])</b> Define the IP Address of the WAN side of the router.	0.0.0.0 ~ 126.255.255.254 128.0.0.1 ~ 191.255.255.254 192.0.0.1 ~ 223.255.255.254	0.0.0.0	✓		
10-12-08	<b>GCD-CP10 Network Setup – ICMP Redirect</b> When receiving ICMP redirect messages, this determines if the IP Routing Table updates automatically or not.	0= (Enable) 1= (Disable)	0		✓	

Program Number	Program Name/Description	Input Data	Default	Level		
				1	2	3
10-12-09	<b>GCD-CP10 Network Setup – IP Address</b> Assign the IP Address for the VoIPDB. If a VoIPDB is installed in the system it is recommended to set Program 10-12-01 to 0.0.0.0 and all connections to the system will be made through the VoIPDB.	0.0.0.0 ~ 126.255.255.254 128.0.0.1 ~ 191.255.255.254 192.0.0.1 ~ 223.255.255.254	172.16.0.10	✓		
10-12-10	<b>GCD-CP10 Network Setup – Subnet Mask</b> Define the Media Gateway Subnet Mask Address.	128.0.0.0   192.0.0.0   224.0.0.0  240.0.0.0   248.0.0.0   252.0.0.0  254.0.0.0   255.0.0.0  255.128.0.0   255.192.0.0  255.224.0.0   255.240.0.0  255.248.0.0   255.252.0.0  255.254.0.0   255.255.0.0  255.255.128.0   255.255.192.0  255.255.224.0   255.255.240.0  255.255.248.0   255.255.252.0  255.255.254.0   255.255.255.0  255.255.255.128  255.255.255.192  255.255.255.224  255.255.255.240  255.255.255.248  255.255.255.252  255.255.255.254  255.255.255.255	255.255.0.0		✓	
10-12-11	<b>GCD-CP10 Network Setup – NIC Setup</b> Define the LAN interface Speed and Mode of the VoIP Application supported. ➤ <i>IPLE daughter board does not support half duplex connection.</i>	0 = Auto Detect 1 = 100Mbps, Full Duplex 3 = 10Mbps, Full Duplex 5 = 1Gbps, Full Duplex	0	✓		
10-33-02	<b>SIP Registrar/Proxy Information Basic Setup – Authentication Mode</b> When connecting STD SIP Terminal via NAT, this option must be enabled to prohibit illegal SIP phone registration.	0 = Disable 1 = Enable	0	✓		
10-33-05	<b>SIP Registrar/Proxy Information Basic Setup – NAT Mode</b> When system controls remote SIP phone via NAT router, set this program to 1 = Enable.	0 = Disable 1 = Enable	0	✓		
10-37-01	<b>UPnP Setup – UPnP Mode</b> Enable/Disable UPnP.	0 = Disable 1 = Enable	0		✓	



Program Number	Program Name/Description	Input Data	Default	Level		
				1	2	3
10-54-01	<p><b>License Configuration for Each Package – License Code</b></p> <p>Assign VoIP Resource Licenses (5103) to GCD-CP10 slot (1).</p> <p>If applying more than 255 licenses to a slot, the licenses must be applied across multiple indexes.</p> <p>For example, assigning 256 VoIP resource licenses (5103) to the CPU slot could be assigned using different methods as long as the total for the CPU slot is 256.</p> <p>1. Index 1 has 128 of feature code 5103 and index 2 also has 128 of feature code 5103 for a total of 256.</p> <p>2. Index 1 has 255 of feature code 5103 and index 2 has 1 of feature code 5103 for a total of 256.</p>	1 ~ 255 Resource Licenses	0	✓		
10-58-01	<p><b>DT800/DT700 Intranet Local Network Area Setup – Network Address</b></p> <p>This program sets the IP or Network address for phones that are not to be routed through the NAPT translations.</p> <p>For example, if a system had multiple NAPT phones and another site, with multiple IP phones connected via a VPN connection, you would not want the phones connected over the VPN to use the NAPT feature. The network address (or single IP phone addresses) of the Remote location would be entered here. This is for the IP Phones at this location to not use the NAPT feature.</p>	0.0.0.0 ~ 126.255.255.254 128.0.0.1 ~ 191.254.255.254 192.0.0.1 ~ 223.255.255.254	0.0.0.0		✓	
10-58-02	<p><b>DT800/DT700 Intranet Local Network Area Setup – Subnet Mask</b></p> <p>This program sets the netmask for the IP Addresses assigned in Program 10-58-01.</p>	128.0.0.0   192.0.0.0   224.0.0.0  240.0.0.0   248.0.0.0   252.0.0.0  254.0.0.0   255.0.0.0  255.128.0.0   255.192.0.0  255.224.0.0   255.240.0.0  255.248.0.0   255.252.0.0  255.254.0.0   255.255.0.0  255.255.128.0   255.255.192.0  255.255.224.0   255.255.240.0  255.255.248.0   255.255.252.0  255.255.254.0   255.255.255.0  255.255.255.128  255.255.255.192  255.255.255.224  255.255.255.240  255.255.255.248  255.255.255.252  255.255.255.254  255.255.255.255	255.255.0.0		✓	

Program Number	Program Name/Description	Input Data	Default	Level		
				1	2	3
15-05-16	<b>IP Telephone Terminal Basic Data Setup – Authentication Password</b> Assign the authentication password for SIP single line telephones.	Maximum of 24 characters.	No Setting	✓		
15-05-45	<b>IP Telephone Terminal Basic Data Setup – NAT Plug and Play</b> This program is valid when Program 10-46-14 is On (NAT feature activated). Select sending RTP port number to remote Router, use from negotiation result (0) or received RTP packet (1). SV9100 uses this program to decide a destination port of RTP transmitting packets from GPZ-IPLE to a remote IP terminal. If “0:OFF” is selected, the destination port of RTP transmitting packets will be a SIP/SDP negotiation result.(same behavior as before). If you chose “1:ON”, the destination port of RTP transmitting packet will be the same port of a source port of a receiving RTP packet on GPZ-IPLE (GPZ-IPLE required).	0 = Disable 1 = Enable	0	✓		
15-05-47	<b>IP Telephone Terminal Basic Data Setup – Registration Expire Timer for NAT</b> On a per station basis, this setting defines the SIP registration expiry timer. If this value is set to 0, for a NAPT terminal, the value in Program 84-23-01 is applied.	60 ~ 65535 seconds 0 = Disable	180		✓	
15-05-48	<b>IP Telephone Terminal Basic Data Setup – Subscribe Expire Timer for NAT</b> On a per station basis, this setting defines the SIP Subscribe expiry timer. If this value is set to 0, for a NAPT terminal, the value in Program 84-23-02 is applied.	60 ~ 65535 seconds 0 = Disable	180		✓	
15-05-50	<b>IP Telephone Terminal Basic Data Setup – Peer to Peer Mode</b> On a per station basis enable or disable Peer to Peer mode.	0 = Disable 1 = Enable	1	✓		
84-20-01	<b>SIP Extension Basic Information Setup – Registrar/Proxy Port</b> Define SIP station Proxy Port.	1 ~ 65535	5070	✓		
84-26-01	<b>IPL Basic Setup – IP Address</b> Assign the IP address for the DSP on the GPZ-IPLE.	xxx.xxx.xxx.xxx	172.16.0.20	✓		
84-26-02	<b>IPL Basic Setup – RTP Port Number</b> Assign the RTP port number to be used for each DSP on the GPZ-IPLE. ➡ Only even numbered ports are supported.	0 ~ 65534	10020		✓	

Program Number	Program Name/Description	Input Data	Default	Level		
				1	2	3
84-26-03	<b>IPL Basic Setup – RTCP Port Number (RTP Port Number + 1)</b> Define the TCP port number for RTCP to use for each DSP.	0 ~ 65534	10021		✓	

## Operation

None

## IP Trunk – H.323

### Description

H.323 is an International Telecommunication Union (ITU) standard for Packet Based Multimedia Communication Systems. The UNIVERGE SV9100 can use H.323 to connect to another UNIVERGE SV9100 system or a third-party product.

The feature set is limited. When using H.323, it is impossible to use the advanced networking features. If these features are required, use IP KCCIS. The UNIVERGE SV9100 Voice over IP Trunk – H.323 package sends the real-time voice over the corporate LAN or WAN. The voice from the telephone is digitized and then put into frames to be sent over a network using Internet Protocol.

The UNIVERGE SV9100 Voice over IP Trunk – H.323 package allows communication using standard H.323 (Normal and Fast Start) Protocol and allows connectivity to any H.323 standards compliant voice gateway and gatekeeper. This VoIP Trunk Daughter board also allows Registration and Authentication Server (RAS) support to register with an RAS Server and use Gatekeeper for dynamic call routing.

The GPZ-IPLE – H.323 is an optional interface that can provide IP trunks and Tie Lines. It can operate in the following modes:

- COI
- COID
- DID
- TLI
- DTI

Depending on the requirements and resource allocation in the LAN/WAN/Internet, the GPZ-IPLE – H.323 can be configured to use any of the following voice compressions:

- G.729 Low bandwidth requirement is used on most Wide Area Network links.
- G.711 High bandwidth requirement is usually used on Local Area Networks.
- G 722 This Codec is useful in fixed network, Voice over IP applications, where the required bandwidth is typically not prohibitive.

### Conditions

- A maximum of 256 IP Trunks are supported in the SV9100.
- Calling Party Name is not provided for outgoing calls on H.323 trunks.
- With SV9100 software and GPZ-IPLE daughter board installed, half duplex connections are not supported. For troubleshooting purposes, a managed switch capable of port mirroring is required to capture packet data from the SV9100 IPLE Ethernet port.

- All IP trunks (SIP, CCIS, or H.323) must be contiguous. If any IP trunks are added to a system that already has IP trunks installed, and the next set of trunks is not in sequence, then all IP trunks are moved to a new set of sequential trunk numbers.

## Default Settings

None

## System Availability

### Terminals

All Multiline Terminals

### Required Component(s)

- GCD-CP10 with GPZ-IPLE Daughter Board
- 0411 – SV9100 Version Lic (R1)
- 0300 – SV9100 Resource Lic
- 5103 – SV9100 IP Resource Lic
- 5001 – SV9100 IP Trunk Lic

## Related Features

None

## Guide to Feature Programming

The **Level 1**, **Level 2** and **Level 2** columns indicate the programs that are assigned when programming this feature in the order they are most commonly used. These levels are used with PCPro and WebPro wizards for feature programming.

- ❑ Level 1 – these are the most commonly assigned programs for this feature.
- ❑ Level 2 – these are the next most commonly assigned programs for this feature.
- ❑ Level 3 – these programs are not often assigned and require an expert level working knowledge of the system to be properly assigned.

◇ *The items highlighted in gray are read only and cannot be changed.*

Program Number	Program Name/Description	Input Data	Default	Level		
				1	2	3
10-03-01	<b>ETU Setup (GPZ-IPLE Pkg) – Trunk Logical Port Number</b> Displays the port number assigned to the GPZ-IPLE.	0 ~ 200	0		✓	
10-03-02	<b>ETU Setup (GPZ-IPLE Pkg) – Trunk Type</b> Define if the IP Trunks are H.323 or SIP.	0 = H.323 1 = SIP	1	✓		
10-12-03	<b>GCD-CP10 Network Setup – Default Gateway</b> Assign the default gateway IP address for the GCD-CP10.	0.0.0.0 ~ 126.255.255.254 128.0.0.1 ~ 191.255.255.254 192.0.0.1 ~ 223.255.255.254	0.0.0.0	✓		
10-12-09	<b>GCD-CP10 Network Setup – IP Address</b> Set IP address for GPZ-IPLE.	0.0.0.0 ~ 126.255.255.254 128.0.0.1 ~ 191.255.255.254 192.0.0.1 ~ 223.255.255.254	172.16.0.10	✓		
10-12-10	<b>GCD-CP10 Network Setup – Subnet Mask</b> Define the Media Gateway Subnet Mask Address.	128.0.0.0   192.0.0.0   224.0.0.0   240.0.0.0   248.0.0.0   252.0.0.0   254.0.0.0   255.0.0.0   255.128.0.0   255.192.0.0   255.224.0.0   255.240.0.0   255.248.0.0   255.252.0.0   255.254.0.0   255.255.0.0   255.255.128.0   255.255.192.0   255.255.224.0   255.255.240.0   255.255.248.0   255.255.252.0   255.255.254.0   255.255.255.0   255.255.255.128   255.255.255.192   255.255.255.224   255.255.255.240   255.255.255.248   255.255.255.252   255.255.255.254   255.255.255.255	255.255.0.0	✓		
10-17-02	<b>H.323 Gatekeeper Setup – Gatekeeper IP Address</b> Define the Gatekeeper IP address for H.323.	0.0.0.0 ~ 126.255.255.254 128.0.0.1 ~ 191.255.255.254 192.0.0.1 ~ 223.255.255.254	0.0.0.0	✓		
10-17-04	<b>H.323 Gatekeeper Setup – Preferred Gatekeeper</b> When 10-17-01 is set to 1, this is used and sets the preferred ID of multiple gatekeepers.	Maximum of 124 characters.	No Setting	✓		
10-18-01	<b>H.323 Alias Address Setup – Alias Address</b> Set the telephone number (Alias Address) to external gatekeeper.	Dial maximum of 12 digits (0 ~ 9, *, #)	No Setting	✓		
10-18-02	<b>H.323 Alias Address Setup – Alias Address Type</b> Set the Alias Address Type to external gatekeeper.	0 = E164	0	✓		

Program Number	Program Name/Description	Input Data	Default	Level		
				1	2	3
10-23-01	<b>SIP System Interconnection Setup – System Interconnection</b> Determine if the system is interconnected to another system.	0 = No (Disable) 1 = Yes (Enable)	0	✓		
10-23-02	<b>SIP System Interconnection Setup – IP Address</b> Define the IP Address for the SIP System Interconnection.	0.0.0.0 ~ 126.255.255.254 128.0.0.1 ~ 191.255.255.254 192.0.0.1 ~ 223.255.255.254	0.0.0.0	✓		
10-23-04	<b>SIP System Interconnection Setup – Dial Number</b> Define the Dial Number for the SIP System.	Maximum of 12 digits (0 ~ 9).	No Setting	✓		
10-54-01	<b>License Configuration for Each Package – License Code</b> Assign VoIP Resource Licenses (5103) to GCD-CP10 slot (1). If applying more than 255 licenses to a slot, the licenses must be applied across multiple indexes. For example, assigning 256 VoIP resource licenses (5103) to the CPU slot could be assigned using different methods as long as the total for the CPU slot is 256. 1. Index 1 has 128 of feature code 5103 and index 2 also has 128 of feature code 5103 for a total of 256. 2. Index 1 has 255 of feature code 5103 and index 2 has 1 of feature code 5103 for a total of 256.	1 ~ 255 Resource Licenses	0	✓		
10-68-01	<b>IP Trunk Availability – Trunk Type</b> Set trunk type to CCISoIP for interconnecting trunks.	0 = None 1 = SIP 2 = H.323 3 = CCIS	0	✓		
10-68-02	<b>IP Trunk Availability – Start Port</b> Set the trunk port number to start the assignment from.	0 ~ 400	0	✓		
10-68-03	<b>IP Trunk Availability – Number of Ports</b> Set the number of ports to assign from the starting point set in Program 10-68-02.	0 ~ 400	0	✓		
14-02-01	<b>Analog Trunk Data Setup – Signaling Type (DP/DTMF)</b> Set the outgoing signaling type for the tie trunk.	0 = Dial Pulse (10 PPS) 1 = Dial Pulse (20 PPS) 2 = DTMF	2			✓

Program Number	Program Name/Description	Input Data	Default	Level		
				1	2	3
14-05-01	<b>Trunk Group – Trunk Group Number</b> Assign trunks to trunk groups then go to Program 14-06-01 below to set up Trunk Group Routing.	Trunk Port 1 ~ 400 Group Number 0 ~ 100 Priority 1 ~ 400	Default = Trunks 1 ~ 400 assigned to trunk group 1 with priorities equal to the trunk number. Trunk 1 = Priority 1 Trunk 400 = Priority 400.	✓		
14-06-01	<b>Trunk Group Routing – Priority Order Number</b> Set the priority order number 1 ~ 4.	0 = Not Specify 1 ~ 100: (Trunk Group Number) 101 ~ 150: (100 + Networking System Number) 1001 ~ 1100: (1000 + Route Table Number)	Route 1, Order Number 1 = 1 (Trunk Group 1) Order Numbers 2, 3, 4 = 0 (Not Specified) All Other Routes (2 ~ 100) and Order Numbers (1 ~ 4) = 0 (Not Specified)	✓		
20-08-13	<b>Class of Service Options (Outgoing Call Service) – ISDN CLIP</b> Determine if the ISDN calling line identity presentation and screening indicators should be allowed.	0 = Off 1 = On	0	✓		
20-09-02	<b>Class of Service Options (Incoming Call Service) – Caller ID Display</b> Turn Off or On the Caller ID display at an extension.	0 = Off 1 = On	COS 1 ~ 15 = 0	✓		
21-17-01	<b>IP Trunk (SIP) Calling Party Number Setup for Trunk</b> Assign the Caller Party Number for each IP trunk. The assigned number is sent to the central office when the caller places an outgoing call. If the Calling Party Number is assigned by both Program 21-17 and Program 21-18/ 21-19, the system uses the entry in Program 21-18/21-19.	Maximum of 16 digits (1 ~ 0, *, #)	No Setting	✓		
21-18-01	<b>IP Trunk (H.323) Calling Party Number Setup for Extension – IP Trunk (H.323) Calling Party Number Setup for Extension</b> Assign the Calling Party Number for each extension. The assigned number is sent to the exchange when the caller places an outgoing call.	Maximum of 16 digits (1 ~ 0, *, #)	No Setting	✓		



Program Number	Program Name/Description	Input Data	Default	Level		
				1	2	3
22-02-01	<b>Incoming Call Trunk Setup</b> Assign the incoming trunk type for each trunk.	Trunks 1 ~ 400 0 = Normal 1 = VRS (second dial tone if no VRS installed) 2 = DISA 3 = DID 4 = DIL 5 = E&M Tie line 6 = Delayed VRS 7 = ANI/DNIS 8 = DID(DDI) Mode Switching	0		✓	
44-02-01	<b>Dial Analysis Table for ARS/F-Route Access – Dial</b> Set the dial digits to be analyzed by the system for ARS routing.	Maximum of eight digits (Use line key 1 for a 'Don't Care' digit, @).	No Setting		✓	
44-02-02	<b>Dial Analysis Table for ARS/F-Route Access – Service Type</b> Set the Service Type (0 ~ 3) for the Pre-Transaction Table for selecting ARS/F-Route.	0 = No Setting (None) 1 = Extension Call (Own) 2 = ARS/F-Route Table (F-Route) 3 = Dial Extension Analyze Table (Option)	0		✓	
44-02-03	<b>Dial Analysis Table for ARS/F-Route Access – Additional Data</b> If a Service Type is selected in Program 44-02-02, set the additional data, if required, for the Pre-Transaction Table for selecting ARS/F-Route (24 digits max: 1 ~ 9, 0 * #, @). To enter a wild card/don't care digit, press Line Key 1 to enter an @.	1 = Delete Digit = 0 ~ 255 (255: Delete All Digits) 2 = 0 ~ 500 (0 = No Setting) 3 = Dial Extension Analyze Table Number = 0 ~ 4 (0 = No Setting)	0		✓	
44-05-01	<b>ARS/F-Route Table – Trunk Group Number</b> Select the trunk group number to be used for the outgoing ARS call.	0 = No Setting 1 ~ 100 = Trunk Group from Program 14-05 101 ~ 150 = Networking 255 = Extension Call	0		✓	
44-05-09	<b>ARS/F-Route Table – Maximum Digit</b> Input the maximum number of digits to send when using the F-Route.	0 ~ 24	0		✓	
84-01-02	<b>H.323 Trunk Basic Information Setup – Number of G.711 audio frames</b> Define the number of G.711 Audio Frames.	1 ~ 4	3		✓	
84-01-03	<b>H.323 Trunk Basic Information Setup – G.711 VAD mode</b> Enable/Disable the G.711 VAD mode for H.323.	0 = Disable 1 = Enable	0		✓	

Program Number	Program Name/Description	Input Data	Default	Level		
				1	2	3
84-01-04	<b>H.323 Trunk Basic Information Setup – G.711 Type</b> Define the G.711 type for H.323.	0 = A-law 1 = $\mu$ -law	1		✓	
84-01-05	<b>H.323 Trunk Basic Information Setup – Number of G.729 audio frames</b> Define the number of G.729 audio frames for H.323.	1 ~ 6 1 = 10ms 2 = 20ms 3 = 30ms 4 = 40ms 5 = 50ms 6 = 60ms	3		✓	
84-01-06	<b>H.323 Trunk Basic Information Setup – G.729 VAD mode</b> Enable/Disable the G.729 VAD mode for H.323.	0 = Disable 1 = Enable	0		✓	
84-01-07	<b>H.323 Trunk Basic Information Setup – G.729 Jitter Buffer (min)</b> Define the G.729 jitter buffer (minimum) for H.323.	0 ~ 270ms	30		✓	
84-01-08	<b>H.323 Trunk Basic Information Setup – G.729 Jitter Buffer (average)</b> Define the G.729 jitter buffer (average) for H.323.	0 ~ 270ms	60		✓	
84-01-09	<b>H.323 Trunk Basic Information Setup – G.729 Jitter Buffer (max)</b> Define the G.729 jitter buffer (maximum) for H.323.	0 ~ 270ms	120		✓	
84-01-15	<b>H.323 Trunk Basic Information Setup – Jitter Buffer Mode</b> Define the jitter buffer mode for H.323.	1 = Fixed 2 = Self adjusting (silence period) 3 = Self adjusting	3		✓	
84-01-16	<b>H.323 Trunk Basic Information Setup – G.711 Jitter Buffer (min)</b> Define the G.711 jitter buffer (minimum) for H.323.	0 ~ 160ms	30		✓	
84-01-17	<b>H.323 Trunk Basic Information Setup – G.711 Jitter Buffer (average)</b> Define the G.711 jitter buffer (average) for H.323.	0 ~ 160ms	60		✓	
84-01-18	<b>H.323 Trunk Basic Information Setup – G.711 Jitter Buffer (max)</b> Define the G.711 jitter buffer (maximum) for H.323.	0 ~ 160ms	120		✓	

Program Number	Program Name/Description	Input Data	Default	Level		
				1	2	3
84-01-22	<b>H.323 Trunk Basic Information Setup – VAD Threshold</b> Define the VAD threshold for H.323.	0 ~ 30 (-19db ~ +10db and self adjustment) 0 = Self adjustment 1 = -19db (-49dbm) : 20 = 0db (-30dbm) : 29 = 9db (-21dbm) 30 = 10db (-20dbm)	20		✓	
84-01-23	<b>H.323 Trunk Basic Information Setup – Idle Noise Level</b> Define the idle noise level for H.323.	-5000dbm ~ -7000dbm	7000		✓	
84-01-24	<b>H.323 Trunk Basic Information Setup – Echo Canceller Mode</b> Enable/Disable the echo canceller mode for H.323.	0 = Disable 1 = Enable	1		✓	
84-01-25	<b>H.323 Trunk Basic Information Setup – Echo Canceller Tail Size</b> Define the echo canceller tail size for H.323.	1 = 4ms 2 = 8ms 3 = 16ms 4 = 32ms 5 = 64ms 6 = 128ms	6		✓	
84-01-26	<b>H.323 Trunk Basic Information Setup – Echo Canceller NLP Mode</b> Define the echo canceller NLP mode for H.323.	0 = Disable 1 = Enable	1		✓	
84-01-28	<b>H.323 Trunk Basic Information Setup – Echo Canceller NLP Noise Setting</b> Define the echo canceller NLP noise setting for H.323.	0 = Automatic level adjustment 1 = Fixed level	0		✓	
84-01-30	<b>H.323 Trunk Basic Information Setup – TX Gain</b> Define the TX gain for H.323.	0 ~ 40 (-20dBm ~ +20dBm)	20		✓	
84-01-31	<b>H.323 Trunk Basic Information Setup – RX Gain</b> Define the RX gain for H.323.	0 ~ 40 (-20dBm ~ +20dBm)	20		✓	
84-01-63	<b>H.323 Trunk Basic Information Setup – Number of G.722 audio frames</b> Define the number of G.722 audio frames for H.323.	1 ~ 4 1 = 10ms 2 = 20ms 3 = 30ms 4 = 40ms	3		✓	
84-01-64	<b>H.323 Trunk Basic Information Setup – G.722 Voice Activity Detection Mode</b> Enable/Disable the G.722 voice activity detection mode for H.323.	0 = Disable 1 = Enable	0		✓	

Program Number	Program Name/Description	Input Data	Default	Level		
				1	2	3
84-01-65	<b>H.323 Trunk Basic Information Setup – G.722 Jitter Buffer (min)</b> Define the G.722 jitter buffer (minimum) for H.323.	0 ~ 160ms	30		✓	
84-01-66	<b>H.323 Trunk Basic Information Setup – G.722 Jitter Buffer (average)</b> Define the G.722 jitter buffer (average) for H.323.	0 ~ 160ms	60		✓	
84-01-67	<b>H.323 Trunk Basic Information Setup – G.722 Jitter Buffer (max)</b> Define the G.722 jitter buffer (maximum) for H.323.	0 ~ 160ms	120		✓	

## Operation

None

## IP Trunk – Multi Gateway Address Support

### Description

With Version 5000 or higher, the SV9100 supports Multi Gateway Address Support. With this enhancement, the Default Gateway Address can be set for every SIP Profile. SIP signaling and media traversal would follow the configuration settings of respective SIP Profile.

Figure 2-47 Multi Gateway Address Support

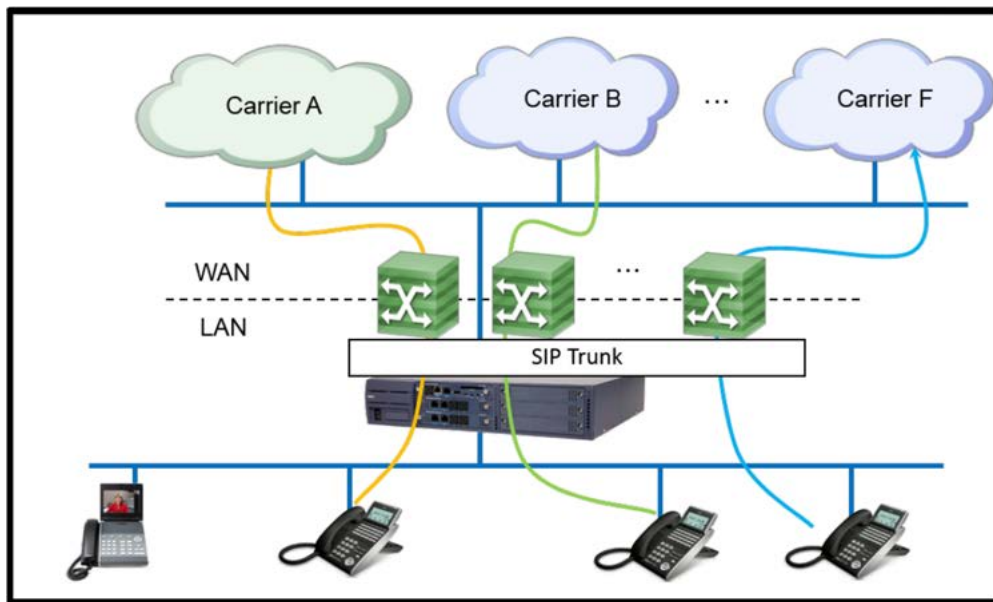

### Conditions

- When the Default Gateway in Program 10-29-22 for every SIP Profile is not set, then the Default Gateway set in Program 10-12-03 is used.
- When UPnP is ON, the WAN IP address of the router is automatically set in Program 10-12-07.
- UPnP and Multi Gateway can be used at the same time.
- IPLE must know the MAC address of the default gateway for Multi Gateway to function.
- If UPnP and Multi gateway support is used simultaneously, the MAC Address is automatically updated in Programs 10-29-23 (Read only) and 10-12-21 (Read only) as per the router set in Programs 10-29-22 and 10-12-03 respectively.

- When Default Gateway is not set for every SIP Profile in Program 10-29-22, Multi Gateway will not function. In this case, Program 10-12-03 is used and the MAC address of the router (Program 10-12-03) is not updated in Program 10-12-21.
- If SIP trunk is configured with the NetLink secondary system, only SIP Profile 1 can be used with Programs 10-12-03 and 10-12-07.
- Multi Gateway is supported with TLS.

## Default Settings

None

## System Availability

### Terminals

All Terminals

### Required Component(s)

- GPZ-IPLE
- 0415 – SV9100 Version Lic (R5)
- 0300 – SV9100 Resource Lic
- 5103 – SV9100 IP Resource Lic
- 5001 – SV9100 IP Trunk Lic

## Related Features

None

## Guide to Feature Programming

The **Level 1**, **Level 2** and **Level 2** columns indicate the programs that are assigned when programming this feature in the order they are most commonly used. These levels are used with PCPro and WebPro wizards for feature programming.

- Level 1 – these are the most commonly assigned programs for this feature.
- Level 2 – these are the next most commonly assigned programs for this feature.
- Level 3 – these programs are not often assigned and require an expert level working knowledge of the system to be properly assigned.

◇ The items highlighted in gray are read only and cannot be changed.

Program Number	Program Name/Description	Input Data	Default	Level		
				1	2	3
10-12-03	<b>GCD-CP10 Network Setup – Default Gateway</b> Assign the default gateway IP address for the GCD-CP10.	0.0.0.0 ~ 126.255.255.254 128.0.0.1 ~ 191.255.255.254 192.0.0.1 ~ 223.255.255.254	0.0.0.0	✓		
10-12-07	<b>GCD-CP10 Network Setup – NAPT Router IP Address (Default Gateway [WAN])</b> Assign the WAN address of the router that the CCPU is using for NAT.	0.0.0.0 ~ 126.255.255.254 128.0.0.1 ~ 191.255.255.254 192.0.0.1 ~ 223.255.255.254	0.0.0.0	✓		
10-12-21	<b>GCD-CP10 Network Setup – MAC Address</b> MAC Address of the router set in Program 10-12-03. (This is a read only program)	00-00-00-00-00-00 ~ FF-FF-FF-FF-FF-FF	00-00-00-00-00-00		✓	
10-29-14	<b>SIP Server Information Setup – SIP Carrier Choice</b> Define the SIP Carrier Choice. <ul style="list-style-type: none"> <li>➤ <i>Selecting Carrier B automatically sets Program 10-29-16 to on (1). Program 10-29-16 MUST be set to off for incoming calls to route using the lowest available trunk port.</i></li> <li>➤ <i>Each certified vendor may use a different carrier type. Visit NTAC website (<a href="http://www.necntac.com">http://www.necntac.com</a>) to verify the proper setting per vendor.</i></li> </ul>	0 ~ 26 1 ~ 26 = Carrier Type A ~ Carrier Type Z  Profile 1 ~ 2 (Version 2000 or lower) Profile 1 ~ 6 (Version 3000 or higher)	0		✓	
10-29-21	<b>SIP Server Information Setup – NAT Router</b> If the SV9100 is connecting to the SIP Carrier using NAT Translations, this setting must be enabled.	0 = Disabled 1 = Enabled  Profile 1 ~ 2 (Version 2000 or lower) Profile 1 ~ 6 (Version 3000 or higher)	0	✓		
10-29-22	<b>SIP Server Information Setup – Default Gateway</b> Assign the default gateway IP address for the GCD-CP10.	0.0.0.0 ~ 126.255.255.254 128.0.0.1 ~ 191.255.255.254 192.0.0.1 ~ 223.255.255.254	0.0.0.0	✓		
10-29-23	<b>SIP Server Information Setup – MAC Address</b> MAC Address of the router set in Program 10-29-22. (This is a read only program)	00-00-00-00-00-00 ~ FF-FF-FF-FF-FF-FF	00-00-00-00-00-00	✓		
10-29-24	<b>SIP Server Information Setup – NAPT Router Address</b> Assign the WAN address of the router that the CCPU is using for NAT.	0.0.0.0 ~ 126.255.255.254 128.0.0.1 ~ 191.255.255.254 192.0.0.1 ~ 223.255.255.254	0.0.0.0	✓		
10-37-01	<b>UPnP Setup – UPnP Mode</b> Enable/Disable UPnP.	0 = Disable 1 = Enable	0	✓		

Program Number	Program Name/Description	Input Data	Default	Level		
				1	2	3
14-18-05	<b>IP Trunk Data Setup – SIP Profile (SIP Trunk)</b> Assign each SIP Trunk to either Profile 1 or Profile 2.	1 = Profile 1 2 = Profile 2 3 = Profile 3 4 = Profile 4 5 = Profile 5 6 = Profile 6 ► With Version 2000 or lower the SV9100 only supports two SIP profiles.	Profile 1	✓		

## Operation

### Multi Gateway:

Figure 2-48 Multi Gateway Address

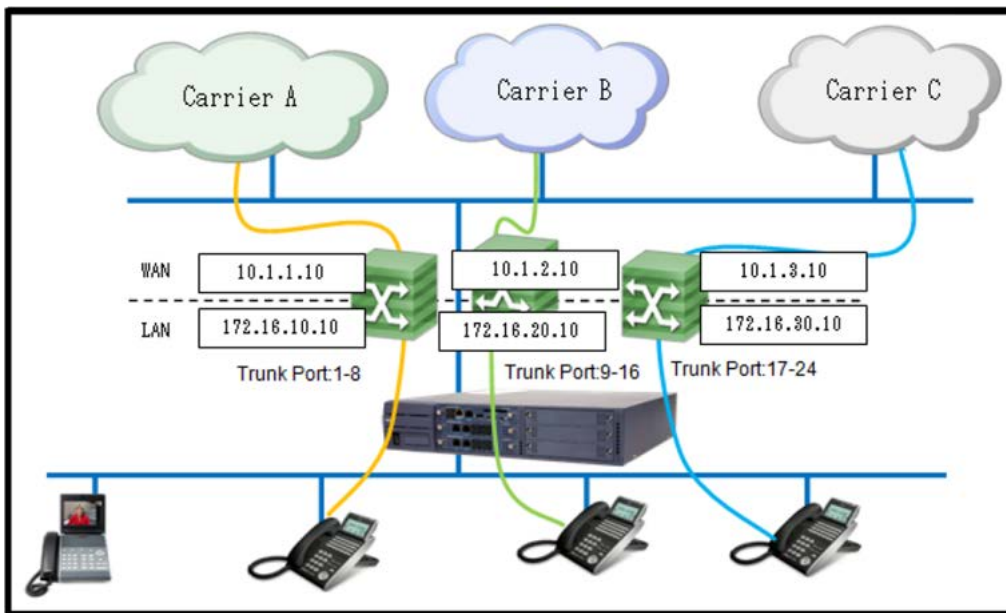

Program	Name	Data
10-29-14	<b>SIP Server Information Setup – SIP Carrier Choice</b>	- SIP Profile 1 SIP Carrier Choice = 1 (Carrier A) - SIP Profile 2 SIP Carrier Choice = 2 (Carrier B) - SIP Profile 3 SIP Carrier Choice = 3 (Carrier C)



Program	Name	Data
10-29-21	SIP Server Information Setup – NAT Router	Used
10-29-22	SIP Server Information Setup – Default Gateway	- SIP Profile 1 172.16.10.10 - SIP Profile 2 172.16.20.10 - SIP Profile 3 172.16.30.10
10-29-24	SIP Server Information Setup – NAPT Router Address	- SIP Profile 1 10.1.1.10 - SIP Profile 2 10.1.2.10 - SIP Profile 3 10.1.3.10
14-18-05	IP Trunk Data Setup – SIP Profile (SIP Trunk)	- Trunk Port: 1-8 SIP Profile = 1 (Profile 1) - Trunk Port: 9-16 SIP Profile = 2 (Profile 2) - Trunk Port: 17-24 SIP Profile = 3 (Profile 3)

### UPnP and Multi Gateway

Figure 2-49 UPnP and Multi Gateway Address

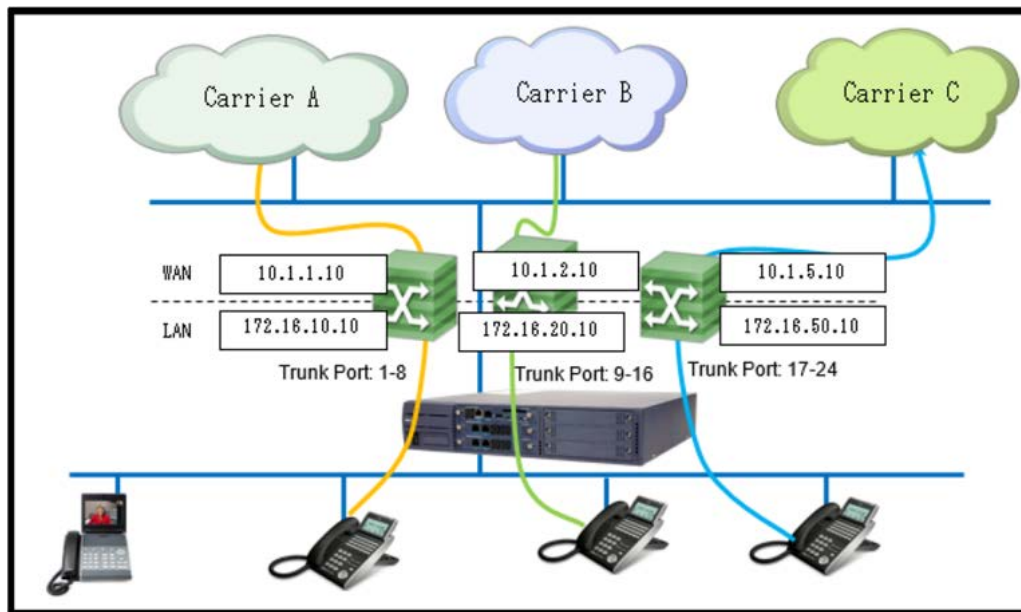

Program	Name	Data
10-12-03	Default Gateway	172.16.50.10
10-29-14	SIP Server Information Setup – SIP Carrier Choice	- SIP Profile 1 SIP Carrier Choice = 1 (Carrier A) - SIP Profile 2 SIP Carrier Choice = 2 (Carrier B) - SIP Profile 3 SIP Carrier Choice = 3 (Carrier C)
10-29-21	SIP Server Information Setup – NAT Router	Used
10-29-22	SIP Server Information Setup – SIP Default Gateway	- SIP Profile 1 172.16.10.10 - SIP Profile 2 172.16.20.10 - SIP Profile 3 0.0.0.0
10-29-24	SIP Server Information Setup – SIP NAPT Router Address	- SIP Profile 1 10.1.1.10 - SIP Profile 2 10.1.2.10 - SIP Profile 3 0.0.0.0
10-37-01	UPnP Mode	1: Enable
14-18-05	IP Trunk Data Setup	- Trunk Port: 1-8 SIP Profile = 1 (Profile 1) - Trunk Port: 9-16 SIP Profile = 2 (Profile 2) - Trunk Port: 17-24 SIP Profile = 3 (Profile 3)

## IP Trunk – TLS Support on SIP Trunk

### Description

With Version 5000 or higher, the TLS protocol is supported on SIP trunks. The SIP message encryption acts only between the SV9100 and a SIP server or a SV9100 and SV9100 (SIP Interconnection).

Figure 2-50 TLS Support on SIP Trunk

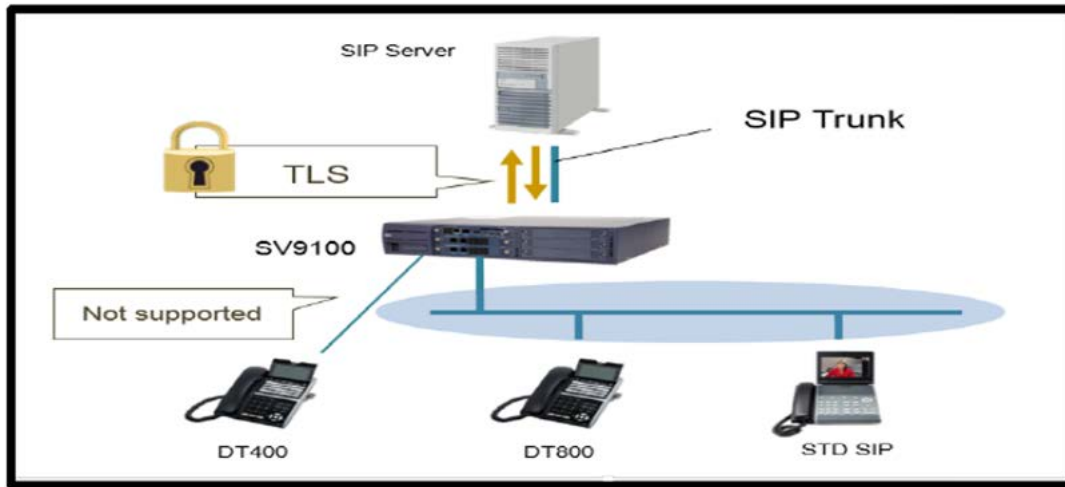

### SIP Server Authentication

Figure 2-51 SIP Server Authentication

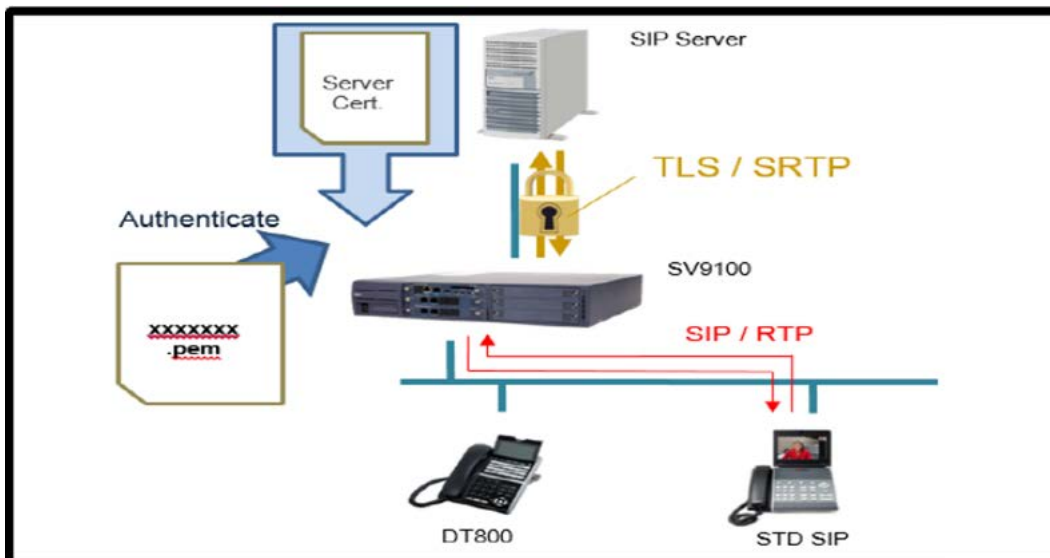

## Conditions

- NAT Traversal is not supported.
- Packets between SV9100 and SIP terminals are not encrypted.
- TLS does not work with carrier type D, J and M.

### TLS with SIP Server

- ❑ Trusted connection is possible by authentication of SIP server. For authentication, the root certificate of a SIP server to SV9100 must be registered.
- ❑ If no root certificate is registered to the SV9100, creating a TLS connection is possible but it would not be trusted.
- ❑ Only certificates using a PEM format is supported. The extension of a certificate file is .pem or .PEM.
- ❑ The file name, including the extension is limited to a maximum of 32 characters.
- ❑ The SV9100 system retains certificate files even after system restart.
- ❑ Certificates can be checked, added and deleted by WebPro under **Certificate Registration**.
- ❑ Only MF level or IN level User can use **Certificate Registration** on WebPro. Certificate Registration is not displayed when SA level or UA level user logs in.
- ❑ If the user set something in Program 84-14-22, the SIP Server is authenticated and if it fails, the TLS connection would not be possible.
- ❑ If the user set nothing in Program 84-14-22, the authentication is skipped, and SV9100 tries to create an untrusted connection.
- ❑ The trunk cannot be used if:
  - The input certificate is invalid. (ex. error in the term of validity)
  - The input certificate does not exist.
- ❑ If the certificate set in Program 84-14-22 has expired or been deleted, the new TLS connection cannot be created and the trunk cannot be used. This will not affect a communication that is already established.

### TLS with SIP Connection

- ❑ To compose SIP interconnection, there are following cases.
  - **No authentication**  
Setting a certificate is not necessary. If no CA Certificate is set, it is connected unconditionally without authentication. Encryption is also done in this case.
  - **Authenticate as SV9100 interconnection Group**  
All systems have the same server certificate, key and CA Certificate.
  - **Authenticate each system**  
The systems have respective server certificates and keys. Other systems have the corresponding CA Certificate.

- ❑ The SV9100 Server Certificate and Private Key are both used when the SV9100 receives a request of TLS connection.
- ❑ When a server certificate is not registered, the SV9100 uses a self-signed certificate.
- ❑ Only certificates using a PEM format is supported. The extension of certificate file is **.pem** or **.PEM**.
- ❑ The supported extension of a Private Key file is **.key** or **.KEY**.
- ❑ The file name, including the extension is limited to a maximum of 32 characters.
- ❑ The SV9100 system retains certificate files even after system restart.
- ❑ Certificates can be checked, added and deleted by WebPro under **Certificate Registration**.
- ❑ Only MF level or IN level users can use **Certificate Registration** on WebPro. Certificate Registration is not displayed when SA level or UA level user logs in.
- ❑ Certificate file name is set in Program 10-72-01 and Private Key file name is set in Program 10-72-02, if the same certificate doesn't exist in SV9100 system, the trunk cannot be used.
- ❑ When the server certificate is set in Program 10-72-01, the Private Key must be set in Program 10-72-02. If the Private Key is invalid or doesn't exist, the trunk cannot be used.

**SRTP Support**

- ❑ To encrypt voice packets, set Program 84-27-03 (SRTP Mode) to **1 Enable**.
  - ❑ If TLS protocol is not used, an encryption of voice packets will not work, even if SRTP Mode is set to enable.
  - ❑ In the case of SIP interconnection, if P2P is Off between two standard SIP terminals while they are communicating and SRTP is enabled, the voice packets are encrypted. P2P settings are Program 14-18-03 (P2P Mode) set to **0 Disable** and Program 15-05-50 (Peer to Peer Mode) set to **0 Disable**.
  - ❑ In case of SIP interconnection, if two standard SIP Terminals have a P2P external call, the voice packets aren't encrypted even though SRTP is enabled because they don't go through the SV9100. P2P settings are Program 14-18-03 (P2P Mode) set to **1 Enable** and Program 15-05-50 (Peer to Peer Mode) set to **1 Enable**.
- Refer to [Table 2-69 Example of Terminal Display Alarms](#) for examples of displayed alarms (Program 90-50-01).

Table 2-69 Example of Terminal Display Alarms

Error	Cause	Correction	Display (28 Characters)
License not available	Encryption license not installed.	License check passes. (When the TLS connection is reestablished or a TLS SIP call is initiated.)	<pre> 1-1 MON 0:00AM TLS ALARM(P:00) No License List  Dir  VMsg  ↓                     </pre>

Table 2-69 Example of Terminal Display Alarms (Continued)

Error	Cause	Correction	Display (28 Characters)
Error in CA Certificate (Program 84-14-22)	Failed to validate CA Certificate.	When TLS connection executes, after setting correct file in Program 84-14-22 (Profile: XX).	<pre> 1-1 MON 0:00AM TLS ALARM(P:XX) Cert Error01 List  Dir  VMsg  ↓                     </pre> XX: SIP Profile
Error in Server Certificate (Program 10-72-01)	Failed to validate Server Certificate.	When SV9100 receives offer of TLS connection, after setting correct file in Program 10-72-01.	<pre> 1-1 MON 0:00AM TLS ALARM(P:00) Cert Error02 List  Dir  VMsg  ↓                     </pre>
Error in Private Key (Program 10-72-02)	Failed to validate Private Key.	When SV9100 receives offer of TLS connection, after setting correct file in Program 10-72-01.	<pre> 1-1 MON 0:00AM TLS ALARM(P:00) Cert Error03 List  Dir  VMsg  ↓                     </pre>
Error in Server Authentication	Failed to authenticate server.	When SV9100 can initiate TLS connection.	<pre> 1-1 MON 0:00AM TLS ALARM(P:XX) Auth ErrorYY List  Dir  VMsg  ↓                     </pre> XX: SIP Profile YY: <b>Authentication Result</b> 01: Certificate is not yet valid 02: Certificate has expired 03: Self-signed Certificate 04: Can't identify server 00: Internal error Refer to <a href="#">Table 2-70 Authentication Result Error Codes</a> on page 2-914.

### Authentication Result

Table 2-70 Authentication Result Error Codes

Code	Error	Reason
01	Certificate is not yet valid	The certificate in Program 84-14-22 is not yet valid or is expired. or the certificate received from SIP server is not yet valid or is expired.
02	Certificate has expired	
03	Self-signed Certificate	The certificate received from SIP server is Self-Signed certificate and same certificate is not set in Program 84-14-22.
04	Can't identify server	Can't identify server using a certificate in Program 84-14-22.

## Default Settings

None

## System Availability

### Terminals

None

### Required Component(s)

- GPZ-IPLE
- 0415 – SV9100 Version Lic (R5)
- 0030 – SV9100 Encryption Lic

## Related Features

None

## Guide to Feature Programming

The **Level 1**, **Level 2** and **Level 2** columns indicate the programs that are assigned when programming this feature in the order they are most commonly used. These levels are used with PCPro and WebPro wizards for feature programming.

- Level 1 – these are the most commonly assigned programs for this feature.
- Level 2 – these are the next most commonly assigned programs for this feature.
- Level 3 – these programs are not often assigned and require an expert level working knowledge of the system to be properly assigned.

Program Number	Program Name/Description	Input Data	Default	Level		
				1	2	3
10-28-03	<b>SIP System Information Setup – Transport Protocol</b> Define the Transport type. This option is always set to UDP.	0 = UDP 1 = TCP 2 = TLS (Version 5000 or higher required)  Profile 1 ~ 2 (Version 2000 or lower) Profile 1 ~ 6 (Version 3000 or higher)	0	✓		
10-72-01	<b>Network Security Setup – Server Certificate</b> Assign the Server Certificate file's name for SV9100.	Maximum of 32 characters	No Setting		✓	
10-72-02	<b>Network Security Setup – Private Key</b> Assign the Private Key file's name for SV9100.	Maximum of 32 characters	No Setting		✓	
84-14-21	<b>SIP Trunk Basic Information Setup – SIP Trunk TLS Port Number</b> Assign the SIP Trunk TLS Port Number.	0 ~ 65535	Defaults: 5061 = SIP Profile 1 5063 = SIP Profile 2 5091 = SIP Profile 3 5093 = SIP Profile 4 5095 = SIP Profile 5 5097 = SIP Profile 6		✓	
84-14-22	<b>SIP Trunk Basic Information Setup – TLS Certificate</b> Assign the Certificate file's name for TLS.	Maximum of 32 characters	No Setting		✓	
84-27-03	<b>IPL Basic Setup – SRTP Mode Setup</b> Enable/Disable SRTP mode to Enable/Disable voice packet encryption.	0 = Disable 1 = Enable	0		✓	
90-10-01	<b>System Alarm Setup – Alarm Type Alarm 74</b> Set the alarm type 74. Set system alarm for TLS SIP error information.	0 = Not Set 1 = Major Alarm 2 = Minor Alarm	0		✓	

## Operation

### Certificate Registration in WebPro:

1. Login to WebPro at MF or IN level.



- Under Administration, click on **Certificate Registration**.

Figure 2-52 Certificate Registration

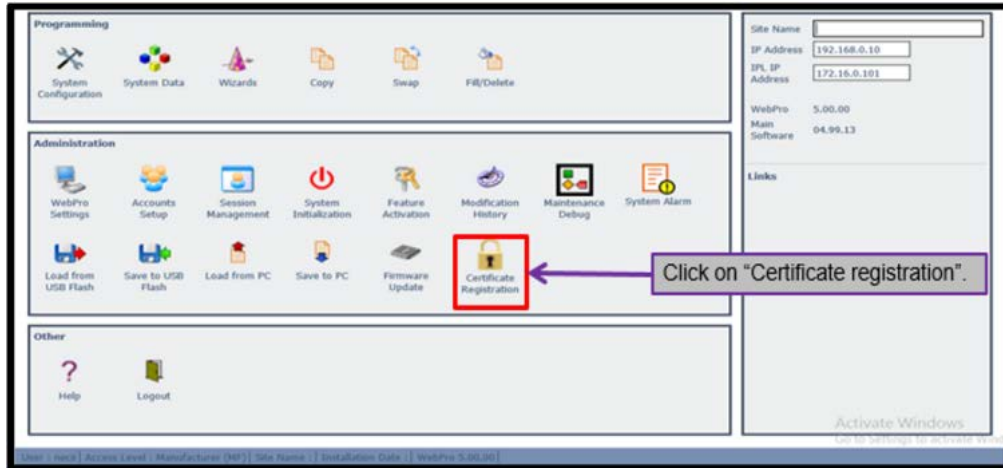

- Select the certificate file and click on **Upload**.

Figure 2-53 Upload Certificate File

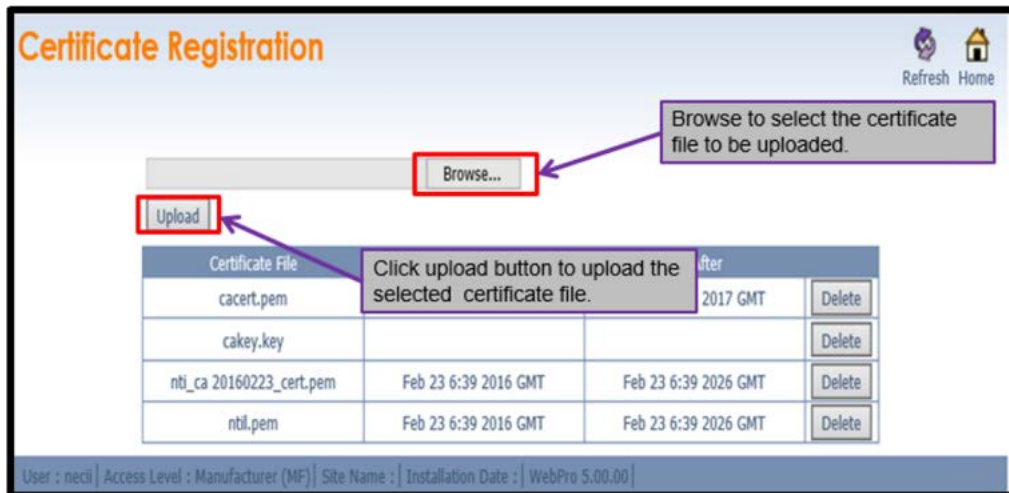

- If no file is selected or invalid extension is selected the following error is displayed:

Figure 2-54 Certificate File Error

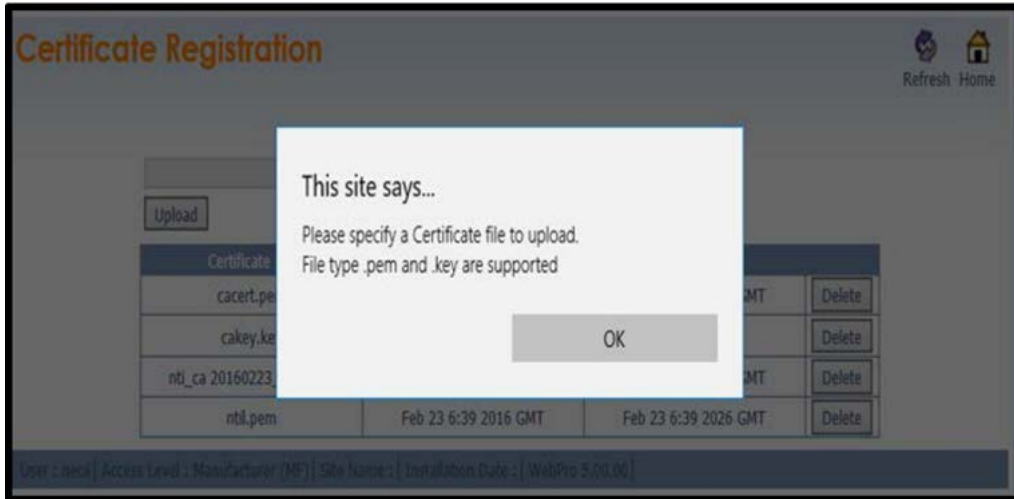

- A maximum of 10 files can be registered. With 10 registered files, the Upload button is deactivated, preventing the user from registering a new file.
- There is a list of the Certificate and Private Key files registered with SV9100 on the Certificate Registration page. **Not Before** and **Not After** columns of Private Key files are displayed as a blank.
- The page is reloaded if the certificate has been uploaded and the certificate file's name is displayed in the list.
- To delete, find the certificate file and select the **Delete** button located on the same line.

Figure 2-55 Delete Certificate File

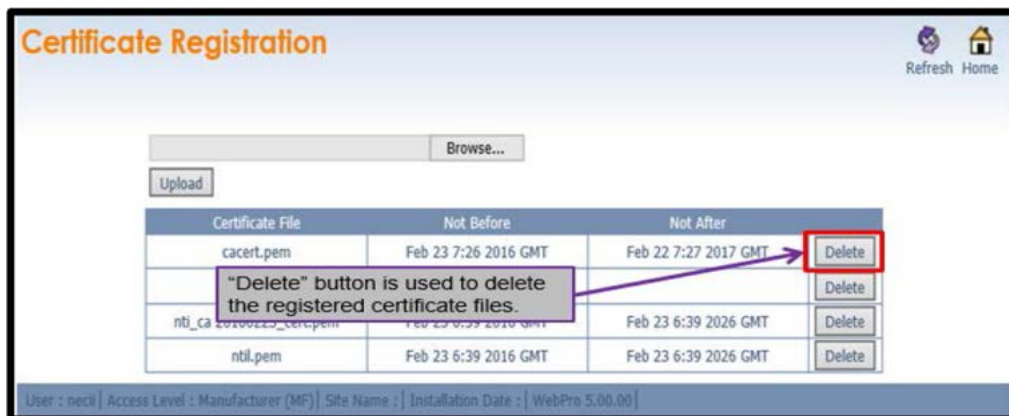

## *IP Trunk – (SIP) Session Initiation Protocol*

### Description

The UNIVERGE SV9100 IP Trunk SIP package sends the real time voice over the corporate LAN or WAN. The voice from the telephone is digitized and then put into frames to be sent over a network using Internet protocol.

Using VoIP equipment at a gateway (a network point that acts as an entrance to another network), the packetized voice transmissions from users in the company are received and routed to other parts of the company Intranet (local area or wide area network) or they can be sent over the Internet using CO lines to another gateway.

The GPZ-IPLE Daughter Board interface can provide IP trunks and Tie Lines that can operate in the following modes:

- COI
- COID
- DID
- TLI
- DTI

Depending on the requirements and resource allocation in the LAN/WAN/Internet, the GPZ-IPLE - SIP can be configured to use any of the following voice compressions:

- G.711  $\mu$ -Law – Highest Bandwidth
- G.729 (a) – Most often used
- The LAN/WAN or Internet connection is provided by a 10 Base-T/100 Base-TX Ethernet.

For a list of vendors that have successfully completed interoperability certification go to <http://www.necntac.com> and refer to Technical Documentation.

## Enhancement

- With **Version 3000 or higher**, the SV9100 supports a maximum of six SIP Profiles allowing you to connect to a multiple of SIP Carriers and have different SIP System Interconnections at the same time.

Figure 2-56 SIP Profile Support on SV9100

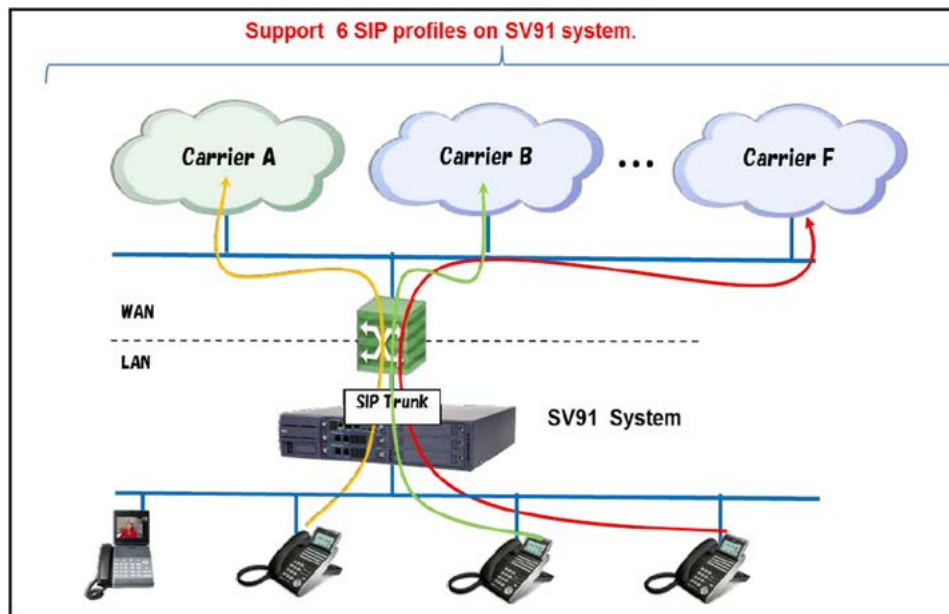

## Conditions

- With **Version 2000 or lower**, the SV9100 you can have two SIP Profiles allowing you to connect to two different SIP Carriers, or allow you to have a SIP System Interconnection and connection to a SIP Carrier.
- The SV9100 can support six SIP profiles. Multiple carriers or SIP System can be used at the same time.
- A SIP profile is set to each SIP trunk in Program 14-18-05.
- VoIP DSP is required if a call is made via SIP trunk. Program 10-19 (IPL DSP Resource Selection) should be set to either **Use for SIP Trunks** or **Common Use**.
- The option to set the SIP trunk Codec to G711 or G729 Fixed is supported in Program 84-13-28.
- A maximum of 400 IP Trunks are supported in the SV9100.
- The SV9100 supports G.711 or T.38 for FAX.
- The SV9100 does not support fallback to G.711 from G.729/G.726 for data (FAX) calls.

- A transferred call can not use T.38 at the transferred destination.
- SIP trunks are assigned in increments of four.
- Calling Party Name is not provided for outgoing calls on SIP trunks.
- With SV9100 software and GPZ-IPLD daughter board installed, half duplex connections are not supported. For troubleshooting purposes, a managed switch capable of port mirroring is required to capture packet data from the SV9100 IPLD Ethernet port.
- The SV9100 software enables multiple SIP trunk carriers to be utilized when NetLink is configured. Refer to [SV9100 NetLink on page 2-1523](#) for additional details.
- Each SIP Profile will require a different SIP Listen Port assigned in Program 84-14-06.
- Each SIP Profile will have to connect using one route because the SV9100 can have only one Gateway.
- If SIP Trunks are programmed in a NetLink Secondary system, only SIP Profile 1 can be utilized.
- The SV9100 can only use one DNS Server, two SIP Carriers that require their own DNS Server can't be used.
- During a database migration from SV8100, some memory blocks required for SIP Trunks will not convert. For a list of conversion exceptions refer to [Conversion Exception on page 2-1123](#) under the Migration – SV8100/SV8300 feature.
- VBD is supported on the GPZ-IPLD.
- VBD on SIP trunk is only supported on SLT terminals.
- VBD supports the G.711/G.729 (PCMU/PCMA) CODEC.
- The selection of (FAX or VBD) mode is on a per terminal basis.
  - ◇ *The FAX connection may not work properly when in VBD Mode.*
- VBD supports one way switching from the Voice session to VBD. VBD to Voice session is not supported. When the VBD session ends, the session is closed.
- The VBD feature is not dependent on Carrier Type (Program 10-29-14).
- VBD is only supported on analog terminals and SIP trunks within the same system.
- VoIPDB cancels the VAD and Echo canceler automatically when changed into the VBD CODEC.
- When using VAD on SDP the setting is effective for G.711 and G.729 CODEC types.
- SIP Centrex Transfer is not supported.

## Default Settings

None

## System Availability

### Terminals

All Multiline Terminals

### Required Component(s)

- GPZ-IPLE
- 0413 – SV9100 Version Lic (R3)
- 0300 – SV9100 Resource Lic
- 5103 – SV9100 IP Resource Lic
- 5001 – SV9100 IP Trunk Lic

## SIP Trunk E.164 Support

### Description

With SIP Trunk E.164 Support enabled, the PBX is able to support SIP configurations where the number presentation within the SIP messages is formatted using the E.164 international numbering scheme. Specifically the system is able to handle the + digit when required as the International Access Code.

For example, a normal international SIP call can be dialed and displayed as follows:

Number dialed = **00441202223344**

*Request-URI: Invite sip: 00441202223344@172.16.18.100 SIP/2.0*

With SIP Trunk E.164 Support enabled, the SIP call can be displayed once dialed as:

*Request-URI: Invite sip:+441202223344@172.16.18.100 SIP/2.0*

This display is a requirement of certain SIP ITSPs (Internet Telephony Service Providers) and may require that PBX handle these calls and modify any SIP messages to the correct format accordingly.

This feature uses the following SIP header fields:

Request-URI

To

From

P-Asserted Identity

P-Preferred Identity

### Conditions

- E.164 support is applied on the SIP trunk interface.
- E.164 is supported for all carrier choices (Program 10-29-14).
- Netlink multi-carrier support uses E.164 support across all carrier configurations at the secondary nodes.

### Default Settings

Disabled

## System Availability

### Terminals

All Multiline Terminals

## Trunks

### IP SIP

#### Required Component(s)

- GCD-CP10
- GPZ-IPLE
- 0413 – SV9100 Version Lic (R3)
- 0300 – SV9100 Resource Lic
- 5103 – SV9100 IP Resource Lic
- 5001 – SV9100 IP Trunk Lic



## *SIP Trunk E.164 CLIP Enhancement*

### Description

With the SIP Trunk E.164 CLIP Enhancement enabled, when an incoming SIP call from an external ITSP is presented at the system with a + in the From header field as the international access code, it is recognized and displayed as an international call at the terminal display and also logged in the terminals incoming caller history, allowing any outbound calls made from a multiline terminals caller history possible using this numbering scheme.

This presentation can be a requirement of certain SIP ITSPs (Internet Telephony Service Providers) so it is necessary the PBX can handle these calls and modify any SIP messages to the correct format accordingly.

### Conditions

- E.164 Enhancement is applied for the SIP trunk interface.
- Outgoing call from caller history of incoming calls is only possible from multiline terminals.
- Netlink systems deployed in multiple countries using this feature may not work correctly because the system will not know which international code should be added at each node.

### Default Settings

Disabled

### System Availability

#### Terminals

All Multiline Terminals

#### Trunks

IP SIP

#### Required Component(s)

- GCD-CP10
- GPZ-IPLE
- 0413 – SV9100 Version Lic (R3)
- 0300 – SV9100 Resource Lic

- 5103 – SV9100 IP Resource Lic
- 5001 – SV9100 IP Trunk Lic

## Video Support over SIP Trunks

### Description

The SV9100 can support video calling over SIP interconnection trunks. IP Trunk License (5001), IP Terminal License (5111), SIP Video License (0040), System Port License (0300) and Version R3 License (0413) are required.

### Conditions

- Calls over SIP Interconnection while in P2P mode cannot be put on hold.
- Calls over SIP Interconnection while in P2P mode cannot be transferred, i.e. an internal call cannot be transferred to a SIP Interconnection trunk.
- A video call cannot be changed to a voice call. A voice call cannot be changed to a video call.
- A video caller cannot use CTI/OAI at the same time. The CTI/OAI feature requires P2P to be set to off.
- When the video interconnection using a SIP trunk is configured, other SIP connections such as a SIP carrier connection are not supported in the same system.
- Video capability in the initial invite message is required for the Video Terminal.
- When using an MCU, the SV9100 requires the Carrier Type Setting (Program 10-29-14) to be set to 0 = Standard.
- When using an MCU, the same video capability must be set between the MCU and the Video SIP Terminal.

### Default Settings

This feature is not enabled at default.

### System Availability

#### Terminals

- Polycom HDX4003
- Polycom VVX1500D

#### Required Component(s)

GCD-CP10 with GPZ-IPLE installed.

## Related Features

None

## Guide to Feature Programming

The **Level 1**, **Level 2** and **Level 3** columns indicate the programs that are assigned when programming this feature in the order they are most commonly used. These levels are used with PCPro and WebPro wizards for feature programming.

- Level 1 – these are the most commonly assigned programs for this feature.
- Level 2 – these are the next most commonly assigned programs for this feature.
- Level 3 – these programs are not often assigned and require an expert level working knowledge of the system to be properly assigned.

### IP Trunk – (SIP) Session Initiation Protocol:

Program Number	Program Name/Description	Input Data	Default	Level		
				1	2	3
10-12-03	<b>GCD-CP10 Network Setup – Default Gateway</b> Assign the default gateway IP address for the GCD-CP10.	0.0.0.0 ~ 126.255.255.254 128.0.0.1 ~ 191.255.255.254 192.0.0.1 ~ 223.255.255.254	0.0.0.0	✓		
10-12-05	<b>GCD-CP10 Network Setup – NIC Interface</b> Set up the NIC Interface.	0 = Auto Detect 1 = 100Mbps, Full Duplex 2 = 100Mbps, Half Duplex 3 = 10Mbps, Full Duplex 4 = 10Mbps, Half Duplex 5 = 1Gbps, Full Duplex	0	✓		
10-12-07	<b>GCD-CP10 Network Setup – NAPT Router IP Address (Default Gateway [WAN])</b> Define the IP Address of the WAN side of the router. ➔ <i>Only used when Program 10-29-21 is enabled.</i>	0.0.0.0 ~ 126.255.255.254 128.0.0.1 ~ 191.255.255.254 192.0.0.1 ~ 223.255.255.254	0.0.0.0		✓	
10-12-08	<b>GCD-CP10 Network Setup – ICMP Redirect</b> When receiving ICMP redirect messages, this determines if the IP Routing Table updates automatically or not.	0= (Enable) 1= (Disable)	0	✓		
10-12-09	<b>GCD-CP10 Network Setup – IP Address</b> Set IP address for GPZ-IPLE.	0.0.0.0 ~ 126.255.255.254 128.0.0.1 ~ 191.255.255.254 192.0.0.1 ~ 223.255.255.254	172.16.0.10	✓		

Program Number	Program Name/Description	Input Data	Default	Level		
				1	2	3
10-12-10	<b>GCD-CP10 Network Setup – Subnet Mask</b> Define the Media Gateway Subnet Mask Address.	128.0.0.0   192.0.0.0   224.0.0.0  240.0.0.0   248.0.0.0   252.0.0.0  254.0.0.0   255.0.0.0  255.128.0.0   255.192.0.0  255.224.0.0   255.240.0.0  255.248.0.0   255.252.0.0  255.254.0.0   255.255.0.0  255.255.128.0   255.255.192.0  255.255.224.0   255.255.240.0  255.255.248.0   255.255.252.0  255.255.254.0   255.255.255.0  255.255.255.128  255.255.255.192  255.255.255.224  255.255.255.240  255.255.255.248  255.255.255.252  255.255.255.254  255.255.255.255	255.255.0.0		✓	
10-12-11	<b>GCD-CP10 Network Setup – NIC Setup</b> Define the LAN interface Speed and Mode of the VoIP Application supported. ➡ <i>IPLE daughter board does not support half duplex connection.</i>	0 = Auto Detect 1 = 100Mbps, Full Duplex 3 = 10Mbps, Full Duplex 5 = 1Gbps, Full Duplex	0	✓		
10-19-01	<b>VoIP DSP Resource Selection</b> Select type of GPZ-IPLE DSP Resource. This program setting has no affect on the terminal/trunk port assignment or usage.	0 = Common use for both IP extensions and trunks 1 = IP Extension 2 = SIP Trunk 3 = CCIS/Networking 4 = Use for NetLink 5 = Blocked 6 = Common without Unicast Paging 7 = Multicast Paging 8 = Unicast Paging	0		✓	
10-23-01	<b>SIP System Interconnection Setup – System Interconnection</b> Determine if the system is interconnected to another system.	0 = No (Disable) 1 = Yes (Enable)	0	✓		
10-23-02	<b>SIP System Interconnection Setup – IP Address</b> Define the IP Address of the SIP System Interconnection.	0.0.0.0 ~ 126.255.255.254 128.0.0.1 ~ 191.255.255.254 192.0.0.1 ~ 223.255.255.254	0.0.0.0	✓		
10-23-04	<b>SIP System Interconnection Setup – Dial Number</b> Define Dial Number for the SIP System Interconnection.	Maximum of 12 digits.	No Setting	✓		

Program Number	Program Name/Description	Input Data	Default	Level		
				1	2	3
10-23-06	<b>SIP System Interconnection Setup – SIP Profile</b> Assign the Interconnection to a SIP Profile.	1 = Profile 1 2 = Profile 2 3 = Profile 3 4 = Profile 4 5 = Profile 5 6 = Profile 6  ▶ With Version 2000 or lower the SV9100 only supports two SIP profiles.	1	✓		
10-28-01	<b>SIP System Information Setup – Domain Name</b> Define the Domain name. This information is generally provided by the SIP carrier.	Maximum of 64digits.  Profile 1 ~ 2 (Version 2000 or lower) Profile 1 ~ 6 (Version 3000 or higher)	No Setting	✓		
10-28-02	<b>SIP System Information Setup – Host Name</b> Define the Host name. This information is generally provided by the SIP carrier.	Maximum of 48 digits.  Profile 1 ~ 2 (Version 2000 or lower) Profile 1 ~ 6 (Version 3000 or higher)	No Setting	✓		
10-28-03	<b>SIP System Information Setup – Transport Protocol</b> Define the Transport type. This option is always set to UDP.	0 = UDP 1 = TCP 2 = TLS (Version 5000 or higher required)  Profile 1 ~ 2 (Version 2000 or lower) Profile 1 ~ 6 (Version 3000 or higher)	0	✓		
10-28-05	<b>SIP System Information Setup – Domain Assignment</b> Define the Domain Assignment. This entry is determined by what information the SIP carrier provides. If the SIP carrier provides a server name: SIPconnect-sca@L0.cbeyond.net, then the domain is: L0.cbeyond.net and the host name is SIPconnect-sca.	0 = IP Address 1 = Domain Name  Profile 1 ~ 2 (Version 2000 or lower) Profile 1 ~ 6 (Version 3000 or higher)	0	✓		
10-28-06	<b>SIP System Information Setup – IP Trunk Port Binding</b> Enable/Disable IP Trunk Port binding.	0 = Disable 1 = Enable  Profile 1 ~ 2 (Version 2000 or lower) Profile 1 ~ 6 (Version 3000 or higher)	0	✓		

Program Number	Program Name/Description	Input Data	Default	Level		
				1	2	3
10-29-01	<p><b>SIP Server Information Setup – Default Proxy (Outbound)</b></p> <p>Define the SIP Proxy setup, Default Proxy (Outbound). When SIP trunking is used, this must be on.</p> <p>➡ <i>If entries are made in Program 10-29-xx for an SIP Server and the SIP Server is removed or not used, the entries in Program 10-29-xx must be set back to their default settings. Even if Program 10-29-01 is set to 0 (off), the UNIVERGE SV9100 still checks the settings in the remaining 10-29 programs.</i></p>	<p>0 = Off 1 = On</p> <p>Profile 1 ~ 2 (Version 2000 or lower) Profile 1 ~ 6 (Version 3000 or higher)</p>	0	✓		
10-29-02	<p><b>SIP Server Information Setup – Default Proxy (Inbound)</b></p> <p>Define the Default Proxy (Inbound).</p>	<p>0 = Off 1 = On</p> <p>Profile 1 ~ 2 (Version 2000 or lower) Profile 1 ~ 6 (Version 3000 or higher)</p>	0	✓		
10-29-03	<p><b>SIP Server Information Setup – Default Proxy IP Address</b></p> <p>Enter the default Proxy IP Address if the SIP carrier is using an IP address for the proxy. In most cases, this is left at the default entry as the domain name is used.</p>	<p>0.0.0.0 ~ 126.255.255.254 128.0.0.1 ~ 191.255.255.254 192.0.0.1 ~ 223.255.255.254</p> <p>Profile 1 ~ 2 (Version 2000 or lower) Profile 1 ~ 6 (Version 3000 or higher)</p>	0.0.0.0	✓		
10-29-04	<p><b>SIP Server Information Setup – Default Proxy Port Number</b></p> <p>Define the Proxy Port Number.</p>	<p>0 ~ 65535</p> <p>Profile 1 ~ 2 (Version 2000 or lower) Profile 1 ~ 6 (Version 3000 or higher)</p>	5060	✓		
10-29-05	<p><b>SIP Server Information Setup – Registrar Mode</b></p> <p>This program is used to Enable/Disable the ability to Register to the ITSP.</p> <p>➡ <i>In Registration mode (IP or Domain Name) this MUST be enabled.</i></p>	<p>0 = None 1 = Manual</p> <p>Profile 1 ~ 2 (Version 2000 or lower) Profile 1 ~ 6 (Version 3000 or higher)</p>	0	✓		
10-29-06	<p><b>SIP Server Information Setup – Registrar IP Address</b></p> <p>Define the Registrar IP Address. The carrier may provide an IP address. In most cases, a domain name is used so this entry is left at the default.</p>	<p>0.0.0.0 ~ 126.255.255.254 128.0.0.1 ~ 191.255.255.254 192.0.0.1 ~ 223.255.255.254</p> <p>Profile 1 ~ 2 (Version 2000 or lower) Profile 1 ~ 6 (Version 3000 or higher)</p>	0.0.0.0	✓		

Program Number	Program Name/Description	Input Data	Default	Level		
				1	2	3
10-29-07	<b>SIP Server Information Setup – Registrar Port Number</b> Define the Registrar Port Numbers.	0 ~ 65535  Profile 1 ~ 2 (Version 2000 or lower) Profile 1 ~ 6 (Version 3000 or higher)	5060	✓		
10-29-11	<b>SIP Server Information Setup – Registrar Domain Name</b> Define the Registrar Domain Name (normally provided by the SIP carrier). For example: mysipserver.sipprovider.com	Maximum of 128 characters.  Profile 1 ~ 2 (Version 2000 or lower) Profile 1 ~ 6 (Version 3000 or higher)	No Setting	✓		
10-29-12	<b>SIP Server Information Setup – Domain Name</b> Define the domain name of the SIP PROXY Server provided by the SIP Carrier. For example: if the SIP Proxy server address is proxy.sipprovider.com, you would assign <b>sipprovider.com</b> in this program. ➤ If no SIP Proxy address is provided, use the SIP Registration address as the proxy address.	Maximum of 64 characters.  Profile 1 ~ 2 (Version 2000 or lower) Profile 1 ~ 6 (Version 3000 or higher)	No Setting	✓		
10-29-13	<b>SIP Server Information Setup – Proxy Host Name</b> Assign the Proxy Host Name of the SIP PROXY Server provided by the SIP Carrier. For example: if the SIP Proxy server address is proxy.sipprovider.com, you would assign <b>proxy</b> in the program. ➤ If no SIP Proxy address is provided, use the SIP Registration address as the proxy address.	Maximum of 48 characters.  Profile 1 ~ 2 (Version 2000 or lower) Profile 1 ~ 6 (Version 3000 or higher)	No Setting	✓		
10-29-14	<b>SIP Server Information Setup – SIP Carrier Choice</b> Define the SIP Carrier Choice. ➤ Selecting Carrier B automatically sets Program 10-29-16 to on (1). Program 10-29-16 MUST be set to off for incoming calls to route using the lowest available trunk port. ➤ Each certified vendor may use a different carrier type. Visit NTAC website ( <a href="http://www.necntac.com">http://www.necntac.com</a> ) to verify the proper setting per vendor.	0 ~ 26 1 ~ 26 = Carrier Type A ~ Carrier Type Z  Profile 1 ~ 2 (Version 2000 or lower) Profile 1 ~ 6 (Version 3000 or higher)	0	✓		



Program Number	Program Name/Description	Input Data	Default	Level		
				1	2	3
10-29-15	<p><b>SIP Server Information Setup – Registration Expiry (Expire) Time</b></p> <p>This program defines the SIP Trunk Registration timer.</p> <p>This timer is negotiated between the Carrier and the SV9100 during the registration process. The Carrier will make the final decision on the value to be used which means the value specified in this program may be ignored.</p> <p>➔ <i>When half of this timer expires, the SV9100 will re-register itself with the Carrier.</i></p>	<p>120 ~ 65535 seconds</p> <p>Profile 1 ~ 2 (Version 2000 or lower)</p> <p>Profile 1 ~ 6 (Version 3000 or higher)</p>	3600	✓		
10-29-20	<p><b>SIP Server Information Setup – Authentication Trial</b></p> <p>Define the number of times the SV9100 will attempt to authenticate before timing out and not completing the registration process.</p> <p>➔ <i>Recommend changing this to at least 2 in case the first attempt did not succeed due to network problems or any other issues.</i></p>	<p>0 ~ 9</p> <p>0 = No Authentication</p> <p>Profile 1 ~ 2 (Version 2000 or lower)</p> <p>Profile 1 ~ 6 (Version 3000 or higher)</p>	<p>1</p> <p>(1 Authentication Attempt)</p>	✓		
10-29-21	<p><b>SIP Server Information Setup – NAT Router</b></p> <p>If the SV9100 is connecting to the SIP Carrier using NAT Translations, this setting must be enabled.</p>	<p>0 = Disabled</p> <p>1 = Enabled</p> <p>Profile 1 ~ 2 (Version 2000 or lower)</p> <p>Profile 1 ~ 6 (Version 3000 or higher)</p>	0	✓		
10-36-01	<p><b>SIP Trunk Registration Information Setup – Registration</b></p> <p>Enable/Disable the SIP trunk registration.</p>	<p>0 = Disable</p> <p>1 = Enable</p> <p>Profile 1 ~ 2 (Version 2000 or lower)</p> <p>Profile 1 ~ 6 (Version 3000 or higher)</p>	0	✓		
10-36-02	<p><b>SIP Trunk Registration Information Setup – User ID</b></p> <p>Assign the SIP User ID provided by your SIP Carrier. In most cases this is your 10 digit main billing number. This field is also used to send outbound caller ID information when not programmed on a per station or per trunk basis.</p> <p>➔ <i>For non-registration and SIP Tie Lines to another system, you <b>MUST</b> have a USER ID entered.</i></p>	<p>Maximum of 32 characters.</p> <p>Profile 1 ~ 2 (Version 2000 or lower)</p> <p>Profile 1 ~ 6 (Version 3000 or higher)</p>	No Setting	✓		
10-36-03	<p><b>SIP Trunk Registration Information Setup – Authentication User ID</b></p> <p>Define the Authentication USER ID for the SIP Trunk.</p>	<p>Maximum of 64 characters.</p> <p>Profile 1 ~ 2 (Version 2000 or lower)</p> <p>Profile 1 ~ 6 (Version 3000 or higher)</p>	No Setting	✓		

Program Number	Program Name/Description	Input Data	Default	Level		
				1	2	3
10-36-04	<b>SIP Trunk Registration Information Setup – Authentication Password</b> Define the Authentication Password for the SIP Trunk.	Maximum of 32 characters.  Profile 1 ~ 2 (Version 2000 or lower) Profile 1 ~ 6 (Version 3000 or higher)	No Setting		✓	
10-37-01	<b>UPnP Setup – UPnP Mode</b> Enable/Disable UPnP.	0 = Disable 1 = Enable	0	✓		
10-37-02	<b>UPnP Setup – Retry Time</b> Define the retry time for UPnP.	0, 60 ~ 3600 (1 ~ 59 cannot be input)	60	✓		
10-54-01	<b>License Configuration for Each Package – License Code</b> Assign VoIP Resource Licenses (5103) to GCD-CP10 slot (1). If applying more than 255 licenses to a slot, the licenses must be applied across multiple indexes. For example, assigning 256 VoIP resource licenses (5103) to the CPU slot could be assigned using different methods as long as the total for the CPU slot is 256. 1. Index 1 has 128 of feature code 5103 and index 2 also has 128 of feature code 5103 for a total of 256. 2. Index 1 has 255 of feature code 5103 and index 2 has 1 of feature code 5103 for a total of 256.	1 ~ 255 Resource Licenses	0		✓	
10-67-01	<b>SIP Stack Configuration Setup – DNS Mode</b> Select whether DNS mode is enabled.	0 = Disable 1 = Enable	0	✓		
10-67-02	<b>SIP Stack Configuration Setup – DNS IP Address</b> Set the IP Address of DNS Server. The SV9100 can only use one DNS Server, two SIP Carriers requiring their own DNS Server can't be used.	XXX.XXX.XXX.XXX	0.0.0.0	✓		
10-67-03	<b>SIP Stack Configuration Setup – DNS Port</b> Assign the DNS port.	0 ~ 65535	53		✓	
10-67-04	<b>SIP Stack Configuration Setup – DNS Source Port</b> Assign the DNS source port.	0 ~ 65535	53		✓	
10-68-01	<b>IP Trunk Availability – Trunk Type</b> Assign the trunk type as (1) SIP.	0 = None 1 = SIP 2 = H.323 3 = CCIS (Netlink System ID 0 ~ 50)	0	✓		
10-68-02	<b>IP Trunk Availability – Start Port</b> Assign the Start Port for your SIP trunks.	0 ~ 400 (Netlink System ID 0 ~ 50)	0	✓		

Program Number	Program Name/Description	Input Data	Default	Level		
				1	2	3
10-68-03	<b>IP Trunk Availability – Number of Port</b> Assign the number of SIP port trunks.	0 ~ 400 (Netlink System ID 0 ~ 50)	0	✓		
11-01-01	<b>System Numbering – Service Code</b> Set the system internal (Intercom) numbering plan. The numbering plan assigns the first and second digits dialed and affects the digits an extension user must dial to access other extensions and features, such as service codes and trunk codes. If the default numbering plan does not meet the site requirements, use this program to tailor the system numbering to the site.		Refer to the Programming Manual for default values.	✓		
14-01-24	<b>Basic Trunk Data Setup – Trunk-to-Trunk Outgoing Caller ID through Mode</b> Enable/Disable the ability to send the original Caller ID through when the call is Forward Off-Premise.	0 = Disable (No) 1 = Enable (Yes)	0		✓	
14-05-01	<b>Trunk Group – Trunk Group Number</b> Assign trunks to trunk groups.	Trunk Port 1 ~ 400 Group Number 0 ~ 100 Priority 1 ~ 400	Default = Trunks 1 ~ 400 assigned to trunk group 1 with priorities equal to the trunk number. Trunk 1 = Priority 1 Trunk 400 = Priority 400.	✓		
14-18-05	<b>IP Trunk Data Setup – SIP Profile (SIP Trunk)</b> Assign each SIP Trunk to either Profile 1 or Profile 2.	1 = Profile 1 2 = Profile 2 3 = Profile 3 4 = Profile 4 5 = Profile 5 6 = Profile 6  ➡ With Version 200 or lower the SV9100 only supports two SIP profiles.	Profile 1	✓		
15-03-18	<b>Single Line Telephone Basic Data Setup – Select Special Terminal</b> Used for selecting Special terminal type (FAX or Modem). This setting influences how data is transmitted via SIP trunk.  ➡ Program 15-03-03 must be set to 1 (Special) to use this feature.	Type: 0 = FAX 1 = Modem	0		✓	
15-16	<b>SIP Register ID Setup for Extension – Register ID</b> Define the SIP Register ID for Extensions.	None, 0 ~ 31 (Extension 001 ~ 960)  Profile 1 ~ 2 (Version 2000 or Lower) Profile 1 ~ 6 (Version 3000 or Higher)	No Setting		✓	

Program Number	Program Name/Description	Input Data	Default	Level		
				1	2	3
21-17-01	<p><b>IP Trunk (SIP) Calling Party Number Setup for Trunk</b></p> <p>Assign the Caller Party Number for each IP trunk. The assigned number is sent to the central office when the caller places an outgoing call. If the Calling Party Number is assigned by both Program 21-17 and Program 21-18/ 21-19, the system uses the entry in Program 21-18/21-19.</p>	1 ~ 0, *, # Maximum of 16 digits	No Setting	✓		
21-19-01	<p><b>IP Trunk (SIP) Calling Party Number Setup for Extension</b></p> <p>Assign the Calling Party Number for each extension. The assigned number is sent to the central office when the caller places an outgoing call. If the Calling Party Number is assigned by both Program 21-17 and Program 21-18/Program 21-19, the system uses the data in Program 21-18/Program 21-19.</p>	1 ~ 0, *, # Maximum of 16 digits  Profile 1 ~ 2 (Version 2000 or lower)  Profile 1 ~ 6 (Version 3000 or higher)	No Setting	✓		
22-02-01	<p><b>Incoming Call Trunk Setup</b></p> <p>Assign the incoming trunk type for each trunk.</p>	Trunks 1 ~ 400 0 = Normal 1 = VRS (second dial tone if no VRS installed) 2 = DISA 3 = DID 4 = DIL 5 = E&M Tie line 6 = Delayed VRS 7 = ANI/DNIS 8 = DID(DDI) Mode Switching	0	✓		
44-02-01	<p><b>Dial Analysis Table for ARS/F-Route Access – Dial</b></p> <p>Set the Dial digits for the Pre-Transaction Table for selecting ARS/F-Route (eight digits max: 1 ~ 9, 0 *#, @). To enter a wild card/don't care digit, press Line Key 1 to enter an @.</p>	Maximum of eight digits. (Use line key 1 for a 'Don't Care' digit, @)	No Setting		✓	
44-02-02	<p><b>Dial Analysis Table for ARS/F-Route Access – Service Type</b></p> <p>Set the Service Type (0 ~ 3) for the Pre-Transaction Table for selecting ARS/F-Route.</p>	0 = No Setting (None) 1 = Extension Call (Own) 2 = ARS/F-Route Table (F-Route) 3 = Dial Extension Analyze Table (Option)	0		✓	

Program Number	Program Name/Description	Input Data	Default	Level		
				1	2	3
44-02-03	<b>Dial Analysis Table for ARS/F-Route Access – Additional Data</b> If a Service Type is selected in Program 44-02-02, set the additional data, if required, for the Pre-Transaction Table for selecting ARS/F-Route (24 digits max: 1 ~ 9, 0 * #, @). To enter a wild card/don't care digit, press Line Key 1 to enter an @.	1 = Delete Digit = 0 ~ 255 (255: Delete All Digits) 2 = 0 ~ 500 (0 = No Setting) 3 = Dial Extension Analyze Table Number = 0 ~ 4 (0 = No Setting)	0		✓	
44-05-01	<b>ARS/F-Route Table – Trunk Group Number</b> Assign the trunk group to be used by the ARS/F-Route Table.	0 = No Setting 1 ~ 100 = Trunk Group from Program 14-05 101 ~ 150 = Networking 255 = Extension Call	0		✓	
44-05-09	<b>ARS/F-Route Table – Maximum Digit</b> Input the maximum number of digits to send when using the F-Route.	0 ~ 24	0		✓	
84-10-01	<b>ToS Setup – ToS Mode</b> When Input Data is set to 1, Protocol 7 is invalid. When Data is set to 2, Protocols 2 ~ 6 are invalid.	0 = Disable (Invalid) 1 = IP Precedence 2 = Diffserv	0	✓		
84-10-02	<b>ToS Setup – Priority, IP Precedence</b> 1 = Router queuing priority.	0 ~ 7 0 = Low 7 = High	0	✓		
84-10-03	<b>ToS Setup – Low Delay</b> 1 = Optimize for low delay routing.	0 ~ 1 0 = Normal Delay, Low Delay	0	✓		
84-10-04	<b>ToS Setup – Wideband (Throughout)</b> 1 = Optimize for high bandwidth routing.	0 ~ 1 0 = Normal Throughput 1 = High Throughput	0	✓		
84-10-05	<b>ToS Setup – High Reliability</b> 1 = Optimize for reliability routing.	0 ~ 1 0 = Normal Reliability 1 = Low Reliability	0	✓		
84-10-07	<b>ToS Setup – Priority (D.S.C.P. - Differentiated Services Code Point)</b> DSCP (Differentiated Services Code Point).	0 ~ 63	0	✓		
84-13-01	<b>SIP Trunk CODEC Information Basic Setup – Number of G.711 Audio Frames</b> Set the G.711 Audio Frame Number.	1 ~ 4 1 = 10ms 2 = 20ms 3 = 30ms 4 = 40ms  Profile 1 ~ 2 (Version 2000 or lower) Profile 1 ~ 6 (Version 3000 or higher)	2	✓		

Program Number	Program Name/Description	Input Data	Default	Level		
				1	2	3
84-13-02	<b>SIP Trunk CODEC Information Basic Setup – G.711 Voice Activity Detection Mode</b> Enable/Disable the G.711 VAD Detection Mode.	0 = Disable 1 = Enable  Profile 1 ~ 2 (Version 2000 or lower) Profile 1 ~ 6 (Version 3000 or higher)	0	✓		
84-13-03	<b>SIP Trunk CODEC Information Basic Setup – G.711 Type</b> Define the G.711 type.	0 = A-law 1 = $\mu$ -law  Profile 1 ~ 2 (Version 2000 or lower) Profile 1 ~ 6 (Version 3000 or higher)	1	✓		
84-13-04	<b>SIP Trunk CODEC Information Basic Setup – G.711 Jitter Buffer (min)</b> Set the minimum G.711 Jitter Buffer.	0 ~ 300ms  Profile 1 ~ 2 (Version 2000 or lower) Profile 1 ~ 6 (Version 3000 or higher)	20	✓		
84-13-05	<b>SIP Trunk CODEC Information Basic Setup – G.711 Jitter Buffer (Average)</b> Set the average G.711 Jitter Buffer.	0 ~ 300ms  Profile 1 ~ 2 (Version 2000 or lower) Profile 1 ~ 6 (Version 3000 or higher)	40	✓		
84-13-06	<b>SIP Trunk CODEC Information Basic Setup – G.711 Jitter Buffer (max)</b> Set the maximum G.711 Jitter Buffer.	0 ~ 300ms  Profile 1 ~ 2 (Version 2000 or lower) Profile 1 ~ 6 (Version 3000 or higher)	80	✓		
84-13-07	<b>SIP Trunk CODEC Information Basic Setup – Number of G.729 Audio Frames</b> Set the G.729 Audio Frame Number.	1 = 10ms 2 = 20ms 3 = 30ms 4 = 40ms 5 = 50ms 6 = 60ms  Profile 1 ~ 2 (Version 2000 or lower) Profile 1 ~ 6 (Version 3000 or higher)	2	✓		

Program Number	Program Name/Description	Input Data	Default	Level		
				1	2	3
84-13-08	<b>SIP Trunk CODEC Information Basic Setup – G.729 Voice Activity Detection Mode</b> Enable/Disable the G.729 VAD Detection Mode.	0 = Disable 1 = Enable  Profile 1 ~ 2 (Version 2000 or lower) Profile 1 ~ 6 (Version 3000 or higher)	0	✓		
84-13-09	<b>SIP Trunk CODEC Information Basic Setup – G.729 Jitter Buffer (min)</b> Set the minimum G.729 Jitter Buffer.	0 ~ 300ms  Profile 1 ~ 2 (Version 2000 or lower) Profile 1 ~ 6 (Version 3000 or higher)	20	✓		
84-13-10	<b>SIP Trunk CODEC Information Basic Setup – G.729 Jitter Buffer (Average)</b> Set the average G.729 Jitter Buffer.	0 ~ 300ms  Profile 1 ~ 2 (Version 2000 or lower) Profile 1 ~ 6 (Version 3000 or higher)	40	✓		
84-13-11	<b>SIP Trunk CODEC Information Basic Setup – G.729 Jitter Buffer (max)</b> Set the maximum G.729 Jitter Buffer.	0 ~ 300ms  Profile 1 ~ 2 (Version 2000 or lower) Profile 1 ~ 6 (Version 3000 or higher)	80	✓		
84-13-17	<b>SIP Trunk CODEC Information Basic Setup – Jitter Buffer Mode</b> Set the Jitter Buffer Mode.	1 = Static 2 = Self Adjusting	3	✓		
84-13-18	<b>SIP Trunk CODEC Information Basic Setup – VAD Threshold</b> Set the VAD (Voice Activity Detection) threshold.	0 ~ 30 = -19dB ~ +10dB 1 = -19dB (-49dBm) : 2 = 0dB (-30dBm) : 29 = 9dBm (-21dBm) 30 = 0dBm (-20dBm)  Profile 1 ~ 2 (Version 2000 or lower) Profile 1 ~ 6 (Version 3000 or higher)	20	✓		

Program Number	Program Name/Description	Input Data	Default	Level		
				1	2	3
84-13-28	<b>SIP Trunk CODEC Information Basic Setup – Audio Capability Priority</b> Define the Codec Priority.	0 = G.711_PT 2 = G.729_PT 3 = G.722_PT 4 = G.726_PT 6 = G711_Fix 7 = G729_Fix  Profile 1 ~ 2 (Version 2000 or lower) Profile 1 ~ 6 (Version 3000 or higher)	0		✓	
84-13-33	<b>SIP Trunk CODEC Information Basic Setup – Number of G.722 Audio Frames</b> Define the number of G.722 Audio Frames.	1 ~ 4 1 = 10ms 2 = 20ms 3 = 30ms 4 = 40ms  Profile 1 ~ 2 (Version 2000 or lower) Profile 1 ~ 6 (Version 3000 or higher)	3			✓
84-13-35	<b>SIP Trunk CODEC Information Basic Setup – G.722 Jitter Buffer (min)</b> Define the minimum level for the G.722 jitter buffer.	0 ~ 300ms  Profile 1 ~ 2 (Version 2000 or lower) Profile 1 ~ 6 (Version 3000 or higher)	30		✓	
84-13-36	<b>SIP Trunk CODEC Information Basic Setup – G.722 Jitter Buffer (average)</b> Define the average level for the G.722 Jitter Buffer.	0 ~ 300ms  Profile 1 ~ 2 (Version 2000 or lower) Profile 1 ~ 6 (Version 3000 or higher)	60		✓	
84-13-37	<b>SIP Trunk CODEC Information Basic Setup – G.722 Jitter Buffer (max)</b> Define the Max level for the G.722 Jitter buffer.	0 ~ 300ms  Profile 1 ~ 2 (Version 2000 or lower) Profile 1 ~ 6 (Version 3000 or higher)	120		✓	



Program Number	Program Name/Description	Input Data	Default	Level		
				1	2	3
84-13-38	<b>SIP Trunk CODEC Information Basic Setup – Number of G.726 Audio Frames</b> Define the number of G.726 audio frames.	1 ~ 4 1 = 10ms 2 = 20ms 3 = 30ms 4 = 40ms  Profile 1 ~ 2 (Version 2000 or lower) Profile 1 ~ 6 (Version 3000 or higher)	3		✓	
84-13-39	<b>SIP Trunk CODEC Information Basic Setup – G.726 VAD Mode</b> Enable/Disable the VAD mode for G.726.	0 = Disable 1 = Enable  Profile 1 ~ 2 (Version 2000 or lower) Profile 1 ~ 6 (Version 3000 or higher)	0		✓	
84-13-40	<b>SIP Trunk CODEC Information Basic Setup – G.726 Jitter Buffer (min)</b> Define the minimum level for the G.726 jitter buffer.	0 ~ 300ms  Profile 1 ~ 2 (Version 2000 or lower) Profile 1 ~ 6 (Version 3000 or higher)	30		✓	
84-13-41	<b>SIP Trunk CODEC Information Basic Setup – G.726 Jitter Buffer (average)</b> Define the average level for the G.726 jitter buffer.	0 ~ 300ms  Profile 1 ~ 2 (Version 2000 or lower) Profile 1 ~ 6 (Version 3000 or higher)	60		✓	
84-13-42	<b>SIP Trunk CODEC Information Basic Setup – G.726 Jitter Buffer (max)</b> Define the max level for the G.726 jitter buffer.	0 ~ 300ms  Profile 1 ~ 2 (Version 2000 or lower) Profile 1 ~ 6 (Version 3000 or higher)	120		✓	
84-13-49	<b>SIP Trunk CODEC Information Basic Setup – RTP Filter</b> To avoid incorrect voice pass connection, this program checks the sending side address from received RTP packet at VoIPDB.	0 = Disable 1 = Enable 2 = Enable (Include SSRC) Profile 1 ~ 2 (Version 2000 or lower) Profile 1 ~ 6 (Version 3000 or higher)	0		✓	

Program Number	Program Name/Description	Input Data	Default	Level		
				1	2	3
84-13-65	<b>SIP Trunk CODEC Information Basic Setup – VAD Negotiation on SDP</b> Select whether or not system uses SIP negotiation for VAD usage. When set to '0 = Disable' system disregards SIP negotiation result and always enables the VAD. When set to '1 = Enable' system uses SIP negotiation and decides VDA usage according to the result.	0 = Disable 1 = Enable  Profile 1 ~ 2 (Version 2000 or Lower) Profile 1 ~ 6 (Version 3000 or Higher)	0		✓	
84-13-66	<b>SIP Trunk CODEC Information Basic Setup – Voice Band Data Mode (VBD)</b> Enable or Disable the VBD feature. This program has to set '1 = Enable' when Program15-03-03 is set '1 = Special' and also Program15-03-18 is '1 = Modem' Related: Program 15-03-03, Program 15-03-18	0 = Disable 1 = Enable  Profile 1 ~ 2 (Version 2000 or Lower) Profile 1 ~ 6 (Version 3000 or Higher)	0		✓	
84-13-67	<b>SIP Trunk CODEC Information Basic Setup – VBD Payload</b> Setup the Payload Type number when using VBD.	96 ~ 127	97		✓	
84-13-70	<b>SIP Trunk CODEC Information Basic Setup – Video Quality Mode</b> This program specifies the SIP trunk video quality mode. Use this program in conjunction with Program 84-27-20 for Mode 1 and Program 84-27-21 for Mode 2 video quality settings. Mode 1 = CIF (352x288) Mode 2 = VGA (640x480)	0 = Mode 1 1 = Mode 2	0		✓	
84-13-71	<b>SIP Trunk CODEC Information Basic Setup – Video CODEC</b> This program specifies the video CODEC. At this time only H.264 is supported.	0 = H.264	0		✓	
84-13-72	<b>SIP Trunk CODEC Information Basic Setup – Jitter Buffer Mode for Video</b> This program sets the jitter buffer size adjustment. At default this is set to self adjusting and should only be changed when directed by support.	1 = Static 2 = Self Adjusting  Profile 1 ~ 2 (Version 2000 or Lower) Profile 1 ~ 6 (Version 3000 or Higher)	2		✓	
84-13-73	<b>SIP Trunk CODEC Information Basic Setup – Minimum Jitter Buffer for Video</b> This program sets the minimum value of jitter buffer for the video stream. This value must be smaller than the value of the maximum jitter buffer. This value should only be changed for if needed for highly congested networks.	0 ~ 1000ms  Profile 1 ~ 2 (Version 2000 or Lower) Profile 1 ~ 6 (Version 3000 or Higher)	70ms		✓	

Program Number	Program Name/Description	Input Data	Default	Level		
				1	2	3
84-13-74	<p><b>SIP Trunk CODEC Information Basic Setup – Initial Jitter Buffer for Video</b></p> <p>This program sets the initial value of jitter buffer for the video stream.</p> <p>This value must be smaller than the value of the maximum jitter buffer and bigger than the value of the minimum jitter buffer.</p> <p>This value should only be changed for if needed for highly congested networks.</p>	<p>0 ~ 1000ms</p> <p>Profile 1 ~ 2 (Version 2000 or Lower)</p> <p>Profile 1 ~ 6 (Version 3000 or Higher)</p>	140ms		✓	
84-13-75	<p><b>SIP Trunk CODEC Information Basic Setup – Maximum Jitter Buffer for Video</b></p> <p>This program sets the maximum value of jitter buffer for the video stream.</p> <p>It is used only when Program 84-19-72 (Jitter Buffer Mode for video) is set to 1: Fixed.</p> <p>This value must be bigger than the value of the minimum jitter buffer and should only be changed if needed for highly congested networks.</p>		210ms		✓	
84-14-06	<p><b>SIP Trunk Basic Information Setup – SIP Trunk Port Number</b></p> <p>Set the SIP UA (User Authorized) Trunk port number (Receiving Transport for UNIVERGE SV9100 SIP).</p> <p>➡ Each SIP Profile will need to have a different SIP Listen Port.</p>	<p>1 ~ 65535</p> <p>Profile 1 ~ 2 (Version 2000 or lower)</p> <p>Profile 1 ~ 6 (Version 3000 or higher)</p>	<p>Profile 1 = 5060</p> <p>Profile 2 = 5062</p> <p>Profile 3 = 5090</p> <p>Profile 4 = 5092</p> <p>Profile 5 = 5094</p> <p>Profile 6 = 5096</p> <p>Profile 1 ~ 2 (Version 2000 or Lower)</p> <p>Profile 1 ~ 6 (Version 3000 or Higher)</p>	✓		
84-14-07	<p><b>SIP Trunk Basic Information Setup – Session Timer Value</b></p> <p>The Session Timer, when enabled, will allow periodic refreshing of the SIP session using the SIP Re-Invite message. The refreshing will allow both the SV9100 and the Carrier to determine if the session is still active. The periodic refresh can be used to release calls that are not active anymore when the SIP BYE message may have been lost.</p> <p>➡ When this timer is set to 0, the session timer is NOT included in the SIP Invite message.</p>	<p>1 ~ 65535 seconds</p> <p>Profile 1 ~ 2 (Version 2000 or lower)</p> <p>Profile 1 ~ 6 (Version 3000 or higher)</p>	0		✓	
84-14-08	<p><b>SIP Trunk Basic Information Setup – Minimum Session Timer Value</b></p> <p>This timer controls the minimum accepted value of the Session timer that the SV9100 will allow. If the Session timer from the Carrier is lower than the value defined here, the SV9100 will deny the call.</p>	<p>1 ~ 65535 seconds</p> <p>Profile 1 ~ 2 (Version 2000 or lower)</p> <p>Profile 1 ~ 6 (Version 3000 or higher)</p>	1800	✓		

Program Number	Program Name/Description	Input Data	Default	Level		
				1	2	3
84-14-09	<p><b>SIP Trunk Basic Information Setup – Called Party Information</b></p> <p>This Program is used for inbound calls only. When set to a 0 (Request-URI), the SV9100 will look into the SIP "Request-URI" field to route the inbound call.</p> <p>When set to a 1 (To Header), the SV9100 will look into the SIP "To" field to route the inbound call.</p>	<p>0 = Request URI 1 = To Header</p> <p>Profile 1 ~ 2 (Version 2000 or lower) Profile 1 ~ 6 (Version 3000 or higher)</p>	0		✓	
84-14-10	<p><b>SIP Trunk Basic Information Setup – URL Type</b></p> <p>Define the URL type for SIP trunks.</p>	<p>0 = SIP-URL 1 = TEL-URL</p> <p>Profile 1 ~ 2 (Version 2000 or lower) Profile 1 ~ 6 (Version 3000 or higher)</p>	0		✓	
84-14-11	<p><b>SIP Trunk Basic Information Setup – URL/To HeaderSetting Information</b></p> <p>When set to a 0 (Proxy Server Domain), the SV9100 will use the proxy settings in Programs 10-29-12 and 10-29-13 within the SIP Request-URI and To headers. If neither of these programs are assigned, the value in program 10-12-11 is used.</p> <p>When set to a 1 (SIP UA Domain), the SV9100 will use the domain settings in Program 10-28-02 within the SIP Request-URI and To headers.</p>	<p>0 = Proxy Server Domain 1 = SIP UA Domain</p> <p>Profile 1 ~ 2 (Version 2000 or lower) Profile 1 ~ 6 (Version 3000 or higher)</p>	0			✓
84-14-15	<p><b>SIP Trunk Basic Information Setup – 100rel Settings</b></p> <p>This program specifies if the 100rel message is included or not.</p> <p>When set to a 0 (Use Default Settings), the 100rel will be included in the initial SIP Invite and any provisional 1XX responses (excluding the 100 trying).</p> <p>When set to a 1 (Use opposite settings), the 100rel will NOT be included in the initial SIP Invite and provisional 1XX responses (excluding the 100 trying)</p>	<p>0 = Use Default Settings (100rel included) 1 = Use Opposite Settings (100rel not included)</p> <p>Profile 1 ~ 2 (Version 2000 or lower) Profile 1 ~ 6 (Version 3000 or higher)</p>	0		✓	
84-26-01	<p><b>IPL Basic Setup – IP Address</b></p> <p>Assign the IP address for the DSP on the GPZ-IPLE.</p>	xxx.xxx.xxx.xxx	172.16.0.20	✓		
84-26-02	<p><b>IPL Basic Setup – RTP Port Number</b></p> <p>Assign the RTP port number to be used for each DSP on the GPZ-IPLE.</p> <p>➡ Only even numbered ports are supported.</p>	0 ~ 65534	10020	✓		

Program Number	Program Name/Description	Input Data	Default	Level		
				1	2	3
84-26-03	<b>IPL Basic Setup – RTCP Port Number (RTP Port Number + 1)</b> Define the TCP port number for RTCP to use for each DSP.	0 ~ 65534	10021	✓		
84-31-01	<b>VoIPDB Echo Canceller Setup – TDM Echo Canceller Mode</b> Enable or Disable Echo Canceller mode.	0 = Disable 1 = Enable  Profile 1 ~ 2 (Version 2000 or Lower) Profile 1 ~ 6 (Version 3000 or Higher)	1		✓	
84-31-02	<b>VoIPDB Echo Canceller Setup – TDM Echo Canceller NLP Mode (2W)</b> Set Echo Canceller NLP mode.	0 = Disable 1 = Enable  Profile 1 ~ 2 (Version 2000 or Lower) Profile 1 ~ 6 (Version 3000 or Higher)	1		✓	
84-31-03	<b>VoIPDB Echo Canceller Setup – TDM Echo Canceller Comfort Noise Mode</b> Enable or Disable Echo Canceller Comfort Noise mode.	0 = Disable 1 = Enable  Profile 1 ~ 2 (Version 2000 or Lower) Profile 1 ~ 6 (Version 3000 or Higher)	1		✓	
84-31-05	<b>VoIPDB Echo Canceller Setup – TDM Echo Canceller Tail Displacement</b> Define Echo Canceller tail displacement.	0 ~ 890 (0ms ~ 890ms)  Profile 1 ~ 2 (Version 2000 or Lower) Profile 1 ~ 6 (Version 3000 or Higher)	0		✓	
84-31-06	<b>VoIPDB Echo Canceller Setup – Echo Canceller Tail Length</b> Select Echo Canceller tail length.	1 = 32ms 2 = 48ms 3 = 64ms 5 = 96ms 6 = 112ms 7 = 128ms  Profile 1 ~ 2 (Version 2000 or Lower) Profile 1 ~ 6 (Version 3000 or Higher)	7		✓	

Program Number	Program Name/Description	Input Data	Default	Level		
				1	2	3
84-31-07	<b>VoIPDB Echo Canceller Setup – Echo Canceller Default ERL Level</b> Select Echo Canceller default ERL level.	0 = -9db 1 = -6db 2 = -3db 3 = 0db 4 = 3db 5 = 6db 6 = 9db  Profile 1 ~ 2 (Version 2000 or Lower) Profile 1 ~ 6 (Version 3000 or Higher)	5		✓	
84-31-08	<b>VoIPDB Echo Canceller Setup – Echo Canceller Default Echo type</b> Select Echo Canceller echo type.	1 = Line Echo Canceller 2 = Acoustic Echo Canceller  Profile 1 ~ 2 (Version 2000 or Lower) Profile 1 ~ 6 (Version 3000 or Higher)	1		✓	
84-31-10	<b>VoIPDB Echo Canceller Setup – Echo Canceller Setup-TX Level Control</b> Select TX Level control.	0 = Disable 1 = TX Control Mode 2 = TX Automatic Level Control Mode 3 = TX HLC (high Level)  Profile 1 ~ 2 (Version 2000 or Lower) Profile 1 ~ 6 (Version 3000 or Higher)	3		✓	
84-31-11	<b>VoIPDB Echo Canceller Setup – TX Level Control level</b> Select TX Level control level.	0~16 (-24 ~ +24) 0 = -24dB 1 = -21dB : 8 = 0dB : 15 = 21dB 16 = 24dB  Profile 1 ~ 2 (Version 2000 or Lower) Profile 1 ~ 6 (Version 3000 or Higher)	8		✓	

Program Number	Program Name/Description	Input Data	Default	Level		
				1	2	3
84-31-12	<b>VoIPDB Echo Canceller Setup – TX Automatic Level Control level</b> Select TX Automatic Level control level.	0~12 (-42 ~ -6) 0 = -42dBm 1 = -39dBm : 7 = -21dBm : 11 = -9dBm 12 = -6dBm  Profile 1 ~ 2 (Version 2000 or Lower) Profile 1 ~ 6 (Version 3000 or Higher)	7		✓	
84-31-13	<b>VoIPDB Echo Canceller Setup – TX HLC Threshold</b> Select TX HLC threshold	0~42 (-42 ~ 0) 0 = -42dBm 1 = -41dBm : 41 = -1dBm 42 = 0dBm  Profile 1 ~ 2 (Version 2000 or Lower) Profile 1 ~ 6 (Version 3000 or Higher)	41		✓	
84-31-14	<b>VoIPDB Echo Canceller Setup – TX Signal Limiter Mode</b> Enable/Disable TX signal limiter mode.	0 = Disable 1 = Enable  Profile 1 ~ 2 (Version 2000 or Lower) Profile 1 ~ 6 (Version 3000 or Higher)	1		✓	
84-31-15	<b>VoIPDB Echo Canceller Setup – TX Signal Limiter Threshold</b> Select TX signal limiter threshold.	0~42 (-42 ~ 0) 0 = -42dBm 1 = -41dBm : 41 = -1dBm 42 = 0dBm  Profile 1 ~ 2 (Version 2000 or Lower) Profile 1 ~ 6 (Version 3000 or Higher)	41		✓	

Program Number	Program Name/Description	Input Data	Default	Level		
				1	2	3
84-31-16	<b>VoIPDB Echo Canceller Setup – RX Level Control</b> Select RX Level control.	0 = Disable 1 = RX Level Control Mode 2 = RX Automatic Level Control Flag  Profile 1 ~ 2 (Version 2000 or Lower) Profile 1 ~ 6 (Version 3000 or Higher)	0		✓	
84-31-17	<b>VoIPDB Echo Canceller Setup – RX Level Control Level</b> Level Select RX Level control level.	0~16 (-24 ~ +24) 0 = -24dB 1 = -21dB : 8 = 0dB : 15 = 21dB 16 = 24dB  Profile 1 ~ 2 (Version 2000 or Lower) Profile 1 ~ 6 (Version 3000 or Higher)	8		✓	
84-31-18	<b>VoIPDB Echo Canceller Setup – RX Automatic Level Control Level</b> Select RX Automatic Level control level.	0~12 (-42 ~ -6) 0 = -42dBm 1 = -39dBm : 7 = -21dBm : 11 = -9dBm 12 = -6dBm  Profile 1 ~ 2 (Version 2000 or Lower) Profile 1 ~ 6 (Version 3000 or Higher)	7		✓	
84-31-37	<b>VoIPDB Echo Canceller Setup – Echo Canceller NLP Mode(4W)</b> Select Echo Canceller NLP mode (4W).	0 = Disable 1 = Enable  Profile 1 ~ 2 (Version 2000 or Lower) Profile 1 ~ 6 (Version 3000 or Higher)	1		✓	



Program Number	Program Name/Description	Input Data	Default	Level		
				1	2	3
84-34-01	<b>VoIPDB DTMF Setup – DTFMF Relay Mode</b> This program enables or disables DTMF Relay for Type 3 SIP Trunk.	0 = Disable 1 = RFC2833 2 = H.245  Profile 1 ~ 2 (Version 2000 or Lower) Profile 1 ~ 6 (Version 3000 or Higher)	0	✓		
84-34-02	<b>VoIPDB DTMF Setup – DTMF Payload Number</b> Define DTMF payload number.	96 ~ 127  Profile 1 ~ 2 (Version 2000 or Lower) Profile 1 ~ 6 (Version 3000 or Higher)	110		✓	
84-34-03	<b>VoIPDB DTMF Setup – DTMF Detection Type</b> Define DTMF detection type.	1 ~ 5  Profile 1 ~ 2 (Version 2000 or Lower) Profile 1 ~ 6 (Version 3000 or Higher)	1		✓	
84-34-04	<b>VoIPDB DTMF Setup – DTMF Transmit Type</b> Define DTMF transmit type.	1 ~ 5  Profile 1 ~ 2 (Version 2000 or Lower) Profile 1 ~ 6 (Version 3000 or Higher)	1		✓	
84-34-05	<b>VoIPDB DTMF Setup – DTMF Relay (inband) Retransmit Type</b> Define DTMF relay (inband) retransmit type.	1 ~ 5  Profile 1 ~ 2 (Version 2000 or Lower) Profile 1 ~ 6 (Version 3000 or Higher)	1		✓	
84-38-01	<b>VoIPDB Network Side Echo Canceller Setup – Echo Canceller Mode</b> Select Echo Canceller mode.	0 = Disable 1 = Enable  Profile 1 ~ 2 (Version 2000 or Lower) Profile 1 ~ 6 (Version 3000 or Higher)	0		✓	
84-38-02	<b>VoIPDB Network Side Echo Canceller Setup – Echo Canceller NLP Mode</b> Select Echo Canceller NLP mode	0 = Disable 1 = Enable  Profile 1 ~ 2 (Version 2000 or Lower) Profile 1 ~ 6 (Version 3000 or Higher)	0		✓	

Program Number	Program Name/Description	Input Data	Default	Level		
				1	2	3
84-38-03	<b>VoIPDB Network Side Echo Canceller Setup – Echo Canceller Comfort Noise Mode</b> Select Echo Canceller Comfort Noise mode.	0 = Disable 1 = Enable  Profile 1 ~ 2 (Version 2000 or Lower) Profile 1 ~ 6 (Version 3000 or Higher)	1		✓	
84-38-05	<b>VoIPDB Network Side Echo Canceller Setup – Echo Canceller Tail Displacement</b> Define Echo Canceller tail displacement.	0 ~ 87 (0ms ~ 870ms)  Profile 1 ~ 2 (Version 2000 or Lower) Profile 1 ~ 6 (Version 3000 or Higher)	0		✓	
84-38-06	<b>VoIPDB Network Side Echo Canceller Setup – Echo Canceller Tail Length</b> Select Echo Canceller tail length.	1 = 32ms 2 = 48ms 3 = 64ms 4 = 80ms 5 = 96ms 6 = 112ms 7 = 128ms  Profile 1 ~ 2 (Version 2000 or Lower) Profile 1 ~ 6 (Version 3000 or Higher)	7		✓	
84-38-07	<b>VoIPDB Network Side Echo Canceller Setup – Echo Canceller Default ERL Level</b> Select Echo Canceller default ERL level.	0 ~ 6 (-9db ~ 9db) 0 = -9db 1 = -6db 2 = -3db : 5 = 6db 6 = 9db  Profile 1 ~ 2 (Version 2000 or Lower) Profile 1 ~ 6 (Version 3000 or Higher)	5		✓	
84-38-08	<b>VoIPDB Network Side Echo Canceller Setup – Echo Canceller Echo Type</b> Select Echo Canceller echo type.	1 = Line E.C. 2 = Acoustic. E. C.  Profile 1 ~ 2 (Version 2000 or Lower) Profile 1 ~ 6 (Version 3000 or Higher)	1		✓	

Program Number	Program Name/Description	Input Data	Default	Level		
				1	2	3
84-38-10	<b>VoIPDB Network Side Echo Canceller Setup – TX Level Control</b> Select TX Level control.	0 = Disable 1 = Manual 2 = Auto 3 = HLC  Profile 1 ~ 2 (Version 2000 or Lower) Profile 1 ~ 6 (Version 3000 or Higher)	0		✓	
84-38-11	<b>VoIPDB Network Side Echo Canceller Setup – TX Level Control Level</b> Select TX Level control level.	0 ~ 16 (-24 – 24db) 0 = -24db 1 = -21db 2 = -18db : 8 = 0db : 14 = 18db 15 = 21db 16 = 24db  Profile 1 ~ 2 (Version 2000 or Lower) Profile 1 ~ 6 (Version 3000 or Higher)	8		✓	
84-38-12	<b>VoIPDB Network Side Echo Canceller Setup – TX Automatic Level Control Level</b> Select TX Automatic Level control level.	0 ~ 12 (-42dBm ~ -6) 0 = 42dBm 1 = -39dBm : 7 = -21dBm : 11 = -39dBm 12 = -6dBm  Profile 1 ~ 2 (Version 2000 or Lower) Profile 1 ~ 6 (Version 3000 or Higher)	7		✓	
84-38-13	<b>VoIPDB Network Side Echo Canceller Setup – TX HLC Threshold</b> Define TX HLC threshold.	0 ~ 42 (-42dBm ~ 0dBm) 0 = -42dBm 1 = -41dBm : 42 = 0dBm  Profile 1 ~ 2 (Version 2000 or Lower) Profile 1 ~ 6 (Version 3000 or Higher)	41		✓	

Program Number	Program Name/Description	Input Data	Default	Level		
				1	2	3
84-38-14	<b>VoIPDB Network Side Echo Canceller Setup – TX Signal Limiter Mode</b> Select TX signal limiter mode.	0 = Disable 1 = Enable  Profile 1 ~ 2 (Version 2000 or Lower) Profile 1 ~ 6 (Version 3000 or Higher)	0		✓	
84-38-15	<b>VoIPDB Network Side Echo Canceller Setup – TX Signal Limiter Threshold</b> Define TX signal limiter threshold.	0 ~ 42 (-42dBm ~ 0dBm) 0 = -42dBm 1 = -41dBm : 42 = 0dBm  Profile 1 ~ 2 (Version 2000 or Lower) Profile 1 ~ 6 (Version 3000 or Higher)	41		✓	
84-38-16	<b>VoIPDB Network Side Echo Canceller Setup – RX Level Control</b> Select RX Level control.	0 = Disable 1 = Manual 2 = Auto  Profile 1 ~ 2 (Version 2000 or Lower) Profile 1 ~ 6 (Version 3000 or Higher)	0		✓	
84-38-17	<b>VoIPDB Network Side Echo Canceller Setup – RX Level Control Level</b> Select RX Level control level.	0 ~ 16 (-24 – 24db) 0 = -24db 1 = -21db 2 = -18db : 8 = 0db : 14 = 18db 15 = 21db 16 = 24db  Profile 1 ~ 2 (Version 2000 or Lower) Profile 1 ~ 6 (Version 3000 or Higher)	8		✓	

Program Number	Program Name/Description	Input Data	Default	Level		
				1	2	3
84-38-18	<b>VoIPDB Network Side Echo Canceller Setup – RX Automatic Level Control Level</b> Select RX Automatic Level control level.	0 ~ 12 (-42dBm ~ -6) 0 = 42dBm 1 = -39dBm : 7 = -21dBm : 11 = -39dBm 12 = -6dBm  Profile 1 ~ 2 (Version 2000 or Lower) Profile 1 ~ 6 (Version 3000 or Higher)	7		✓	
90-10-01	<b>System Alarm Setup – Alarm Type</b> Define if Alarms are Minor, Major, or Not Set.	0 = Not Set 1 = Major Alarm 2 = Minor Alarm	No Setting	✓		

**SIP Trunk E.164 Support**

Program Number	Program Name/Description	Input Data	Default	Level		
				1	2	3
10-02-01	<b>Location Setup – Country Code</b> Enter the country code.	Dial (maximum of four digits) 0 ~ 9, *, #	1	✓		
10-02-02	<b>Location Setup – International Access Codes</b> Enter the international access code.	Dial (maximum of four digits) 0 ~ 9, *, #	No Setting	✓		
44-01-02	<b>System Options for ARS/F-Route – Dial Tone Simulation</b> When first dialed, digit matches the data set in this Program, system sends simulated DT to calling party after receiving first digit. Numbering plan for the dial needs to be configured as F-Route in Program 11-01.	Dial (maximum of one digit) 0 ~ 9, *, # cannot be used	No Setting	✓		
44-01-03	<b>System Options for ARS/F-Route – Tone Type</b> Set simulated DT to type which can change the tone used in Program 44-01-02 and Program 44-02-04.	0 = Internal Dial Tone 1 = External Dial Tone	0	✓		

Program Number	Program Name/Description	Input Data	Default	Level		
				1	2	3
84-14-13	<p><b>SIP Trunk Basic Information Setup – Incoming/ Outgoing SIP Trunk for E.164</b></p> <p>When this data is set to 1, then for any outbound SIP calls a + is added as a prefix to the Request-URI, To and From header fields of the SIP message.</p> <p>When it is set to 2 then if the dialed international access code matches the value in Program 10-02-02 this value is removed from the number dialed and the + added as a prefix to the Request-URI, To and From header fields of the SIP Message.</p>	<p>0 = Off 1 = Mode 1 2 = Mode 2 3 = Mode 3</p> <p>Profile 1 ~ 2 (Version 2000 or lower) Profile 1 ~ 6 (Version 3000 or higher)</p>	0	✓		

### SIP Trunk E.164 CLIP Enhancement

Program Number	Program Name/Description	Input Data	Default	Level		
				1	2	3
10-02-01	<p><b>Location Setup – Country Code</b></p> <p>Enter the country code.</p>	<p>Dial (maximum of four digits) 0 ~ 9, *, #</p>	1	✓		
10-02-02	<p><b>Location Setup – International Access Codes</b></p> <p>Enter the international access code.</p>	<p>Dial (maximum of four digits) 0 ~ 9, *, #</p>	No Setting	✓		
10-02-03	<p><b>Location Setup – Other Area Access Code</b></p> <p>Enter the other area access code.</p>	<p>Dial (maximum of two digits) 0 ~ 9, *, #</p>	9	✓		
84-14-13	<p><b>SIP Trunk Basic Information Setup – Incoming/ Outgoing SIP Trunk for E.164</b></p> <p>When this data is set to 1, then for any outbound SIP calls a + is added as a prefix to the Request-URI, To and From header fields of the SIP message.</p> <p>When it is set to 2 then if the dialed international access code matches the value in Program 10-02-02 this value is removed from the number dialed and the + added as a prefix to the Request-URI, To and From header fields of the SIP Message.</p>	<p>0 = Off 1 = Mode 1 2 = Mode 2 3 = Mode 3</p> <p>Profile 1 ~ 2 (Version 2000 or lower) Profile 1 ~ 6 (Version 3000 or higher)</p>	0	✓		

Program Number	Program Name/Description	Input Data	Default	Level		
				1	2	3
84-14-16	<p><b>SIP Trunk Basic Information Setup – SIP Trunk SIP-URI E.164 Incoming Mode</b></p> <p>When this data is set to 1, then for any inbound SIP calls that include a + and a country code not defined in Program 10-02-01, delete the + and add the International Access Code in Program 10-02-02. If the country code is a match then delete both the + and country code but do not add the International Access code.</p> <p>When it is set to 2, then for any inbound SIP calls that include a + and a country code not defined in Program 10-02-01, delete the + and add the International Access Code in Program 10-02-02. If the country code is a match then delete both the + and country code and add the Caller ID Edit Code from Program 10-02-03.</p>	<p>0 = Disable 1 = Mode 1 2 = Mode 2</p> <p>(Profile 1 ~ 2 (Version 2000 or lower) Profile 1 ~ 6 (Version 3000 or higher)</p>	0	✓		

**Video Support over SIP Trunks**

Program Number	Program Name/Description	Input Data	Default	Level		
				1	2	3
10-12-01	<p><b>GCD-CP10 Network Setup – IP Address</b></p> <p>It is recommended to set this program to <b>0.0.0.0</b>. All connections to the system are made through the IPLE.</p>	<p>0.0.0.0 ~ 126.255.255.254 128.0.0.1 ~ 191.255.255.254 192.0.0.1 ~ 223.255.255.254</p>	192.168.0.10		✓	
10-12-03	<p><b>GCD-CP10 Network Setup – Default Gateway</b></p> <p>Assign the default gateway IP address for the GCD-CP10.</p>	<p>0.0.0.0 ~ 126.255.255.254 128.0.0.1 ~ 191.255.255.254 192.0.0.1 ~ 223.255.255.254</p>	0.0.0.0	✓		
10-12-08	<p><b>GCD-CP10 Network Setup – ICMP Redirect</b></p> <p>When receiving ICMP redirect messages, this determines if the IP Routing Table updates automatically or not.</p>	<p>0= (Enable) 1= (Disable)</p>	0		✓	
10-12-09	<p><b>GCD-CP10 Network Setup – IP Address</b></p> <p>Set IP address for IPLE.</p> <p>➡ The IP Address assigned in Program 10-12-01 cannot start with the same leading digits as the IP Address assigned here.</p>	<p>0.0.0.0 ~ 126.255.255.254 128.0.0.1 ~ 191.255.255.254 192.0.0.1 ~ 223.255.255.254</p>	172.16.0.10	✓		

Program Number		Input Data	Default	Level		
				1	2	3
10-12-10	<b>GCD-CP10 Network Setup – Subnet Mask</b> Define the Media Gateway Subnet Mask Address.	128.0.0.0   192.0.0.0   224.0.0.0  240.0.0.0   248.0.0.0   252.0.0.0  254.0.0.0   255.0.0.0  255.128.0.0   255.192.0.0  255.224.0.0   255.240.0.0  255.248.0.0   255.252.0.0  255.254.0.0   255.255.0.0  255.255.128.0   255.255.192.0  255.255.224.0   255.255.240.0  255.255.248.0   255.255.252.0  255.255.254.0   255.255.255.0  255.255.255.128  255.255.255.192  255.255.255.224  255.255.255.240  255.255.255.248  255.255.255.252  255.255.255.254  255.255.255.255	255.255.0.0	✓		
10-12-11	<b>GCD-CP10 Network Setup – NIC Setup</b> Define the LAN interface Speed and Mode of the VoIP Application supported. ➤ <i>IPLE daughter board does not support half duplex connection.</i>	0 = Auto Detect 1 = 100Mbps, Full Duplex 3 = 10Mbps, Full Duplex 5 = 1Gbps, Full Duplex	0	✓		
10-23-01	<b>SIP System Interconnection Setup – System Interconnection</b> Determine if the system is interconnected to another system. ➤ <i>For the SIP System Interconnection set to 1 (Yes).</i>	0 = No (Disable) 1 = Yes (Enable)	0	✓		
10-23-02	<b>SIP System Interconnection Setup – IP Address</b> Define the IP Address for the SIP System Interconnection.	0.0.0.0 ~ 126.255.255.254 128.0.0.1 ~ 191.255.255.254 192.0.0.1 ~ 223.255.255.254	0.0.0.0	✓		
10-23-04	<b>SIP System Interconnection Setup – Dial Number</b> Define the Dial Number for the SIP System.	Maximum of 12 digits (0 ~ 9)	No Setting	✓		
10-23-06	<b>SIP System Interconnection Setup – SIP Profile</b> Assign the Interconnection to a SIP Profile.	1 = Profile 1 2 = Profile 2 3 = Profile 3 4 = Profile 4 5 = Profile 5 6 = Profile 6 ➤ <i>With SV9100 Version 2000 or Lower only two SIP profiles are supported.</i>	1	✓		



Program Number		Input Data	Default	Level		
				1	2	3
10-36-02	<p><b>SIP Trunk Registration Information Setup – User ID</b></p> <p>Assign the SIP User ID provided by your SIP Carrier. In most cases this is your 10 digit main billing number. This field is also used to send outbound caller ID information when not programmed on a per station or per trunk basis.</p> <p>➡ For non-registration and SIP Tie Lines to another system, you <b>MUST</b> have a USER ID entered.</p>	<p>Maximum of 32 characters.</p> <p>Profile 1 ~ 2 (Version 2000 or lower)</p> <p>Profile 1 ~ 6 (Version 3000 or higher)</p>	No Setting	✓		
10-54-01	<p><b>License Configuration for Each Package – License Code</b></p> <p>Assign VoIP Resource Licenses (5103) to GCD-CP10 slot (1).</p> <p>If applying more than 255 licenses to a slot, the licenses must be applied across multiple indexes.</p> <p>For example, assigning 256 VoIP resource licenses (5103) to the CPU slot could be assigned using different methods as long as the total for the CPU slot is 256.</p> <p>1. Index 1 has 128 of feature code 5103 and index 2 also has 128 of feature code 5103 for a total of 256.</p> <p>2. Index 1 has 255 of feature code 5103 and index 2 has 1 of feature code 5103 for a total of 256.</p>	1 ~ 255 Resource Licenses	0	✓		
11-01-01	<p><b>System Numbering – Service Code</b></p> <p>Assign the 1st and 2nd dial digit to F-Route for Remote System Extension Numbering.</p>		Refer to the Programming Manual for default values.	✓		
11-02-01	<p><b>Extension Numbering – Dial (Up to 8 Digits)</b></p> <p>Assign extension numbers to Extension ports.</p>	Maximum of eight digits.	<p>1 101</p> <p>2 102</p> <p>3 103</p> <p>~ ~</p> <p>99 199</p> <p>100 3101</p> <p>~ ~</p> <p>960 3961</p>		✓	
14-05-01	<p><b>Trunk Group – Trunk Group Number</b></p> <p>Assign SIP Trunks to same Trunk Group.</p>	<p>Trunk Port 1 ~ 400</p> <p>Group Number 0 ~ 100</p> <p>Priority 1 ~ 400</p>	<p>Default = Trunks 1 ~ 400 assigned to trunk group 1 with priorities equal to the trunk number.</p> <p>Trunk 1 = Priority 1</p> <p>Trunk 400 = Priority 400.</p>	✓		

Program Number	Input Data	Default	Level		
			1	2	3
<b>14-18-03</b> <b>IP Trunk Data Setup – P2P Mode</b> Enable/Disable P2P Mode. ➤ For Video Call via the System Interconnection set to 1 (Enable).	0 = Disable 1 = Enable	0	✓		
<b>14-18-04</b> <b>IP Trunk Data Setup – Video Mode</b> Enable/Disable Video Mode. ➤ For Video Call via the System Interconnection set to 1 (Enable).	0 = Disable 1 = Enable	0	✓		
<b>14-18-05</b> <b>IP Trunk Data Setup – SIP Profile (SIP Trunk)</b> Assign each SIP Trunk to either Profile 1 or Profile 2.	1 = Profile 1 2 = Profile 2 3 = Profile 3 4 = Profile 4 5 = Profile 5 6 = Profile 6 ➤ With SV9100 Version 2000 or Lower only two SIP profiles are supported.	Profile 1	✓		
<b>15-05-43</b> <b>IP Telephone Terminal Basic Data Setup – Video Mode</b> Enable/Disable Video Mode for Standard SIP terminals. ➤ For Video Call via the System Interconnection set to 1 (Enable).	0 = Disable 1 = Enable	0	✓		
<b>15-05-50</b> <b>IP Telephone Terminal Basic Data Setup – Peer to Peer Mode</b> On a per station basis enable or disable Peer to Peer mode. ➤ For Video Call to function set to 1 (Enable).	0 = Disable 1 = Enable	1	✓		
<b>20-08-13</b> <b>Class of Service Options (Outgoing Call Service) – ISDN CLIP</b> Determine if the ISDN calling line identity presentation and screening indicators should be allowed.	0 = Off 1 = On	0		✓	
<b>21-17-01</b> <b>IP Trunk (SIP) Calling Party Number Setup for Trunk</b> Assign the Caller Party Number for each IP trunk. The assigned number is sent to the central office when the caller places an outgoing call. If the Calling Party Number is assigned by both Program 21-17 and Program 21-18/ 21-19, the system uses the entry in Program 21-18/21-19.	Maximum of 16 digits (0 ~ 9, *, #)	No Setting		✓	

Program Number		Input Data	Default	Level		
				1	2	3
21-19-01	<p><b>IP Trunk (SIP) Calling Party Number Setup for Extension</b></p> <p>Assign the Calling Party Number for each extension. The assigned number is sent to the central office when the caller places an outgoing call. If the Calling Party Number is assigned by both Program 21-17 and Program 21-18/Program 21-19, the system uses the data in Program 21-18/Program 21-19.</p>	<p>Maximum of 16 digits (0 ~ 9, *, #)</p> <p>Profile 1 ~ 2 (Version 2000 or lower)</p> <p>Profile 1 ~ 6 (Version 3000 or higher)</p>	No Setting		✓	
22-02-01	<p><b>Incoming Call Trunk Setup</b></p> <p>Assign the incoming trunk type for each trunk.</p> <p>➡ For the SIP System Interconnection, set each trunk to 5 (E&amp;M Tie Line).</p>	<p>Trunks 1 ~ 400</p> <p>0 = Normal</p> <p>1 = VRS (second dial tone if no VRS installed)</p> <p>2 = DISA</p> <p>3 = DID</p> <p>4 = DIL</p> <p>5 = E&amp;M Tie line</p> <p>6 = Delayed VRS</p> <p>7 = ANI/DNIS</p> <p>8 = DID(DDI) Mode Switching</p>	0		✓	
44-02-01	<p><b>Dial Analysis Table for ARS/F-Route Access – Dial</b></p> <p>Set the Dial digits for the Pre-Transaction Table for selecting ARS/F-Route (eight digits maximum: 1~9, 0 #, @).</p> <p>➡ To enter a wild card/don't care digit, press Line Key 1 to enter an @.</p>	Maximum of eight digits.	No Setting	✓		
44-02-02	<p><b>Dial Analysis Table for ARS/F-Route Access – Service Type</b></p> <p>Set the Service Type (0 ~ 3) for the Pre-Transaction Table for selecting ARS/F-Route.</p> <p>➡ For the SIP System Interconnection, set each Dial Digit to 2 (F-Route).</p>	<p>0 = No Setting (None)</p> <p>1 = Extension Call (Own)</p> <p>2 = ARS/F-Route Table (F-Route)</p> <p>3 = Dial Extension Analyze Table (Option)</p>	0		✓	
44-02-03	<p><b>Dial Analysis Table for ARS/F-Route Access – Additional Data</b></p> <p>This is the F-Route Table set in Program 44-05.</p>	<p>1 = Delete Digit = 0 ~ 255 (255: Delete All Digits)</p> <p>2 = 0 ~ 500 (0 = No Setting)</p> <p>3 = Dial Extension Analyze Table Number = 0 ~ 4 (0 = No Setting)</p>	0		✓	
44-05-01	<p><b>ARS/F-Route Table – Trunk Group Number</b></p> <p>Assign the Trunk Group to be used by the F-Route Table.</p> <p>➡ This is the Trunk Group assigned to the SIP System Interconnection trunks in Program 14-05-01.</p>	<p>0 = No Setting</p> <p>1 ~ 100 = Trunk Group from Program 14-05</p> <p>101 ~ 150 = Networking</p> <p>255 = Extension Call</p>	0		✓	
44-05-09	<p><b>ARS/F-Route Table – Maximum Digit</b></p> <p>Input the maximum number of digits to send when using the F-Route.</p>	0 ~ 24	0		✓	

Program Number	Input Data	Default	Level		
			1	2	3
<b>84-26-01</b>	<b>IPL Basic Setup – IP Address</b> Assign the IP address for the DSP on the GPZ-IPLE.	xxx.xxx.xxx.xxx		✓	

## Operation

### SIP Trunk E.164 Support

#### To make a call using E.164 number format:

- Lift the handset or press **Speaker**.
- Dial **00441202223344#**.
  - ◇ *The system automatically modifies the required header fields of the SIP INVITE message using the configuration settings in the table below before forwarding to the ITSP.*

Table 2-71 SIP INVITE Header Fields

Program 84-14-13	Program 10-02-01	Program 10-02-02	Description Calling Party Number = 441509555123 Called Party Number = 00441202223344
0	44	–	Request-URI: Invite sip: 00441202223344@172.16.18.100 SIP/2.0 To header: To:sip:00441202223344@172.16.18.100 From header: From<sip:441509555123@172.16.0.10>
	No Setting	–	Request-URI: Invite sip: 00441202223344@172.16.18.100 SIP/2.0 To header: To:sip:00441202223344@172.16.18.100 From header: From<sip:441509555123@172.16.0.10>
1	44	–	Request-URI: Invite sip:+4400441202223344@172.16.18.100 SIP/2.0 To header: To:sip:+4400441202223344@172.16.18.100 From header: From<sip:+44441509555123@172.16.0.10>
	No Setting	–	Request-URI: Invite sip:+00441202223344@172.16.18.100 SIP/2.0 To header: To:sip:+00441202223344@172.16.18.100 From header: From<sip:+441509555123@172.16.0.10>
2	–	00	Request-URI: Invite sip:+441202223344@172.16.18.100 SIP/2.0 To header: To:<sip:+441202223344@172.16.18.100> From header: From<sip:441509555123@172.16.0.10> P-Asserted-Identity: P-Asserted-Identity441509555123@172.16.0.10> P-Preferred-Identity: P-Preferred-Identity441509555123@172.16.0.10>
	–	No Setting	No Function

SIP Trunk E.164 CLIP Enhancement

Delete the + only from an incoming SIP INVITE using E.164 numbering scheme:

Table 2-72 Delete + from Incoming SIP INVITE

Program 84-14-16	Program 84-14-13	Description
0: Off	0: Off Or 1: On	When a + is presented as the international access code in a SIP INVITE for incoming calls then delete the + only.

<Example Output>

Incoming call from: +4902131795770

Displayed in terminal incoming caller history as:

01:	4902131795770
* 3-5	11:17
↑	↓ Store DEL

Original

Delete and replace the + and matched country code from an incoming SIP INVITE using E.164 numbering scheme:

Table 2-73 Delete + and Country Code from Incoming SIP INVITE

Program 84-14-16	Program 84-14-13	Description
1: Mode 1	1: On	With a SIP INVITE for incoming calls. When a + is presented as the international access code along with a country code that <b>DOES NOT</b> match the value in Program 10-02-01, then delete the + and add the international access code value in Program 10-02-02 only. <b>- Or -</b> With a SIP INVITE for incoming calls. When a + is presented as the international access code along with a country code that <b>DOES</b> match the value in Program 10-02-01, then delete the + and country code but <b>DO NOT</b> add the international access code value.

<Example Output>

Incoming call from: +4902131795770

Program 10-02-02 = 00

Displayed in terminal incoming caller history as:

01:	4902131795770
*	3-5 11:17
↑	↓ Store DEL

Original

01:	004902131795770
*	3-5 11:17
↑	↓ Store DEL

Program 10-02-01 = 0

01:	02131795770
*	3-5 11:17
↑	↓ Store DEL

Program 10-02-01 = 49

**Delete and replace the + and matched country code from an incoming SIP INVITE using E.164 numbering scheme:**

Table 2-74 Delete + and Country Code from Incoming SIP INVITE

Program 84-14-16	Program 84-14-13	Description
2: Mode 2	1: On	<p>With a SIP INVITE for incoming calls. When a + is presented as the international access code along with a country code that <b>DOES NOT</b> match the value in Program 10-02-01, then delete the + and add the international access code value in Program 10-02-02 only.</p> <p><b>- Or -</b></p> <p>With a SIP INVITE for incoming calls. When a + is presented as the international access code along with a country code that <b>DOES</b> match the value in Program 10-02-01, then delete the + and country code and add Caller ID, edit code in Program 10-02-03 .</p>

<Example Output>

Incoming call from: +4902131795770

Program 10-02-02 = 00

Program 10-02-03 = 9

Displayed in terminal incoming caller history as:

01:	4902131795770
*	3-5 11:17
↑	↓ Store DEL

Original

01:	004902131795770
*	3-5 11:17
↑	↓ Store DEL

Program 10-02-01 = 0

01:	902131795770
*	3-5 11:17
↑	↓ Store DEL

Program 10-02-01 = 49

**Making an outgoing call from history of incoming calls:**

1. From an idle multiline terminal.
2. Press soft key **List**.
3. Press soft key **CID**.
4. Press **Speaker**.

## *SIP Trunk – Fax Pass-Through*

### Description

The SV9100 supports SIP trunk Fax pass-through using either the T.38 relay or Pass-Through mode. If the SIP Carrier supports a T.38 Fax relay, select the T.38 mode. If the SIP carrier does not support T.38 Fax relay, then select the Pass-Through mode. The type of Fax relay should be selected manually as per the SIP carrier capability.

### Conditions

- This feature is supported on the SIP carrier types specified in Program 10-29-14.
- When the system detects a Fax tone or Codec exchange from the other side during conversation, the system changes to a Codec specified for Fax in Program 84-33-12.
- Supported Fax Codecs are G.711 a-law, G.711 u-law and G.726.
- It is necessary to set the same Fax Codec on both systems. If the Codec does not match, the Fax call will fail. The SIP/RTP session will continue. It is necessary to perform a disconnect operation in this case.
- If one side changes the Codec and the other side does not, the FAX call will fail.
- The Codec exchange will continue until the call is terminated.
- To establish a Fax call, set Program 15-03-03 to **1** (Special – Receive DTMF tones after the initial call is setup) and Program 15-03-18 to **0** (Fax).
- STD SIP terminals do not support this functionality.
- When the Fax call is complete, the SIP session will be disconnected.

### Default Setting

Disabled

### System Availability

#### Terminals

None

This function is not supported for STD SIP.

## Trunks

SIP Trunks

### Required Component(s)

GPZ-IPLE

## Related Features

None

## Guide to Feature Programming

The **Level 1**, **Level 2** and **Level 3** columns indicate the programs that are assigned when programming this feature in the order they are most commonly used. These levels are used with PCPro and WebPro wizards for feature programming.

- Level 1 – these are the most commonly assigned programs for this feature.
- Level 2 – these are the next most commonly assigned programs for this feature.
- Level 3 – these programs are not often assigned and require an expert level working knowledge of the system to be properly assigned.

Program Number	Program Name/Description	Input Data	Default	Level		
				1	2	3
10-12-03	<b>GCD-CP10 Network Setup – Default Gateway</b> Assign the default gateway IP address for the GCD-CP10.	0.0.0.0 ~ 126.255.255.254 128.0.0.1 ~ 191.255.255.254 192.0.0.1 ~ 223.255.255.254	0.0.0.0		✓	
10-12-07	<b>GCD-CP10 Network Setup – NAPT Router IP Address (Default Gateway [WAN])</b> Assign the WAN address of the router that the CCPU is using for NAT.	0.0.0.0 ~ 126.255.255.254 128.0.0.1 ~ 191.255.255.254 192.0.0.1 ~ 223.255.255.254	0.0.0.0		✓	
10-12-09	<b>GCD-CP10 Network Setup – IP Address</b> Set IP address for GPZ-IPLE. ➡ <i>The IP Address assigned in Program 10-12-01 cannot start with the same leading digits as the IP Address assigned here.</i>	0.0.0.0 ~ 126.255.255.254 128.0.0.1 ~ 191.255.255.254 192.0.0.1 ~ 223.255.255.254	172.16.0.10	✓		



Program Number	Program Name/Description	Input Data	Default	Level		
				1	2	3
10-12-10	<b>GCD-CP10 Network Setup – Subnet Mask</b> Define the Subnet Mask for the VoIPDB unit.	128.0.0.0   192.0.0.0   224.0.0.0  240.0.0.0   248.0.0.0   252.0.0.0  254.0.0.0   255.0.0.0  255.128.0.0   255.192.0.0  255.224.0.0   255.240.0.0  255.248.0.0   255.252.0.0  255.254.0.0   255.255.0.0  255.255.128.0   255.255.192.0  255.255.224.0   255.255.240.0  255.255.248.0   255.255.252.0  255.255.254.0   255.255.255.0  255.255.255.128  255.255.255.192  255.255.255.224  255.255.255.240  255.255.255.248  255.255.255.252  255.255.255.254  255.255.255.255	255.255.0.0		✓	
10-28-01	<b>SIP System Information Setup – Domain Name</b> Define the Domain name. This information is generally provided by the SIP carrier.	Maximum of 64digits.  (Profile 1 ~ Profile 2)Profile 1 ~ 2 (Version 2000 or lower) Profile 1 ~ 6 (Version 3000 or higher)	No Setting		✓	
10-28-02	<b>SIP System Information Setup – Host Name</b> Define the Host name. This information is generally provided by the SIP carrier.	Maximum of 48 digits.  (Profile 1 ~ Profile 2)Profile 1 ~ 2 (Version 2000 or lower) Profile 1 ~ 6 (Version 3000 or higher)	No Setting		✓	
10-28-03	<b>SIP System Information Setup – Transport Protocol</b> Define the Transport type. This option is always set to UDP.	0 = UDP 1 = TCP 2 = TLS (Version 5000 or higher required)  (Profile 1 ~ Profile 2)Profile 1 ~ 2 (Version 2000 or lower) Profile 1 ~ 6 (Version 3000 or higher)	0	✓		

Program Number	Program Name/Description	Input Data	Default	Level		
				1	2	3
10-29-01	<p><b>SIP Server Information Setup – Default Proxy (Outbound)</b></p> <p>Define the SIP Proxy setup, Default Proxy (Outbound). When SIP trunking is used, this must be on.</p> <p>➤ <i>If entries are made in Program 10-29-xx for an SIP Server and the SIP Server is removed or not used, the entries in Program 10-29-xx must be set back to their default settings. Even if Program 10-29-01 is set to 0 (off), the UNIVERGE SV9100 still checks the settings in the remaining 10-29 programs.</i></p>	<p>0 = Off 1 = On</p> <p>(Profile 1 ~ Profile 2)Profile 1 ~ 2 (Version 2000 or lower) Profile 1 ~ 6 (Version 3000 or higher)</p>	0	✓		
10-29-02	<p><b>SIP Server Information Setup – Default Proxy (Inbound)</b></p> <p>Define the Default Proxy (Inbound).</p>	<p>0 = Off 1 = On</p> <p>Profile 1 ~ 2 (Version 2000 or lower) Profile 1 ~ 6 (Version 3000 or higher)</p>	0	✓		
10-29-03	<p><b>SIP Server Information Setup – Default Proxy IP Address</b></p> <p>Enter the default Proxy IP Address if the SIP carrier is using an IP address for the proxy. In most cases, this is left at the default entry as the domain name is used.</p>	<p>0.0.0.0 ~ 126.255.255.254 128.0.0.1 ~ 191.255.255.254 192.0.0.1 ~ 223.255.255.254</p> <p>Profile 1 ~ 2 (Version 2000 or lower) Profile 1 ~ 6 (Version 3000 or higher)</p>	0.0.0.0	✓		
10-29-04	<p><b>SIP Server Information Setup – Default Proxy Port Number</b></p> <p>Define the Proxy Port Number.</p>	<p>0 ~ 65535</p> <p>Profile 1 ~ 2 (Version 2000 or lower) Profile 1 ~ 6 (Version 3000 or higher)</p>	5060	✓		
10-29-05	<p><b>SIP Server Information Setup – Registrar Mode</b></p> <p>This program is used to Enable/Disable the ability to Register to the ITSP.</p> <p>➤ <i>In Registration mode (IP or Domain Name) this MUST be enabled.</i></p>	<p>0 = None 1 = Manual</p> <p>Profile 1 ~ 2 (Version 2000 or lower) Profile 1 ~ 6 (Version 3000 or higher)</p>	0	✓		
10-29-06	<p><b>SIP Server Information Setup – Registrar IP Address</b></p> <p>Define the Registrar IP Address. The carrier may provide an IP address. In most cases, a domain name is used so this entry is left at the default.</p>	<p>0.0.0.0 ~ 126.255.255.254 128.0.0.1 ~ 191.255.255.254 192.0.0.1 ~ 223.255.255.254</p> <p>Profile 1 ~ 2 (Version 2000 or lower) Profile 1 ~ 6 (Version 3000 or higher)</p>	0.0.0.0	✓		

Program Number	Program Name/Description	Input Data	Default	Level		
				1	2	3
10-29-07	<p><b>SIP Server Information Setup – Registrar Port Number</b> Define the Registrar Port Numbers.</p>	<p>0 ~ 65535</p> <p>Profile 1 ~ 2 (Version 2000 or lower) Profile 1 ~ 6 (Version 3000 or higher)</p>	5060	✓		
10-29-14	<p><b>SIP Server Information Setup – SIP Carrier Choice</b> Define the SIP Carrier Choice.</p> <p>➤ <i>Selecting Carrier B automatically sets Program 10-29-16 to on (1). Program 10-29-16 MUST be set to off for incoming calls to route using the lowest available trunk port.</i></p> <p>➤ <i>Each certified vendor may use a different carrier type. Visit NTAC website (<a href="http://www.necntac.com">http://www.necntac.com</a>) to verify the proper setting per vendor.</i></p>	<p>0 ~ 26 1 ~ 26 = Carrier Type A ~ Carrier Type Z</p> <p>Profile 1 ~ 2 (Version 2000 or lower) Profile 1 ~ 6 (Version 3000 or higher)</p>	0	✓		
10-29-21	<p><b>SIP Server Information Setup – NAT Router</b> If the SV9100 is connecting to the SIP Carrier using NAT Translations, this setting must be enabled.</p>	<p>0 = Not Used 1 = Used</p> <p>Profile 1 ~ 2 (Version 2000 or lower) Profile 1 ~ 6 (Version 3000 or higher)</p>	0		✓	
10-36-01	<p><b>SIP Trunk Registration Information Setup – Registration</b> Enable/Disable the SIP trunk registration.</p>	<p>0 = Disable 1 = Enable</p> <p>Profile 1 ~ 2 (Version 2000 or lower) Profile 1 ~ 6 (Version 3000 or higher)</p>	0	✓		
10-36-02	<p><b>SIP Trunk Registration Information Setup – User ID</b> Assign the SIP User ID provided by your SIP Carrier. In most cases this is your 10 digit main billing number. This field is also used to send outbound caller ID information when not programmed on a per station or per trunk basis.</p> <p>➤ <i>For non-registration and SIP Tie Lines to another system, you <b>MUST</b> have a USER ID entered.</i></p>	<p>Maximum of 32 characters.</p> <p>Profile 1 ~ 2 (Version 2000 or lower) Profile 1 ~ 6 (Version 3000 or higher)</p>	No Setting	✓		
10-36-03	<p><b>SIP Trunk Registration Information Setup – Authentication User ID</b> Define the Authentication USER ID for the SIP Trunk.</p>	<p>Maximum of 64 characters.</p> <p>Profile 1 ~ 2 (Version 2000 or lower) Profile 1 ~ 6 (Version 3000 or higher)</p>	No Setting	✓		

Program Number	Program Name/Description	Input Data	Default	Level		
				1	2	3
10-36-04	<b>SIP Trunk Registration Information Setup – Authentication Password</b> Define the Authentication Password for the SIP Trunk.	Maximum of 32 characters.  Profile 1 ~ 2 (Version 2000 or lower) Profile 1 ~ 6 (Version 3000 or higher)	No Setting	✓		
10-68-01	<b>IP Trunk Availability – Trunk Type</b> Assign the trunk type as 1 (SIP).	0 = None 1 = SIP 2 = H.323 3 = CCIS	0	✓		
10-68-02	<b>IP Trunk Availability – Start Port</b> Set the trunk port number to start the assignment from.	0 ~ 400	0	✓		
10-68-03	<b>IP Trunk Availability – Number of Ports</b> Set the number of ports to assign from the starting point set in Program 10-68-02.	0 ~ 400	0	✓		
15-03-03	<b>Single Line Telephone Basic Data Setup – Terminal Type</b> Enter 1 for this option to allow the SIP Station ports to receive DTMF tones after the initial call setup. For the Appointment Reminder, always enter 1 (e.g., receive DTMF tones).	0 = Normal 1 = Special	0	✓		
15-03-18	<b>Single Line Telephone Basic Data Setup – Select Special Terminal</b> Used for selecting Special terminal type (FAX or Modem). This setting influences how data is transmitted via SIP trunk.  ➡ Program 15-03-03 must be set to 1 (Special) to use this feature.	Type: 0 = FAX 1 = Modem	0	✓		
84-13-28	<b>SIP Trunk CODEC Information Basic Setup – Audio Capability Priority</b> Define the Codec Priority for voice session establishment.	0 = G.711_PT 2 = G.729_PT 3 = G.722_PT 4 = G.726_PT 6 = G711_Fix 7 = G729_Fix  Profile 1 ~ 2 (Version 2000 or lower) Profile 1 ~ 6 (Version 3000 or higher)	0	✓		
84-33	<b>FAX over IP Setup – Index 1 - Trunk Type</b> Set the type of SIP trunk for Fax through SIP trunk.	1 = H.323 Trunk 2 = Networking 3 = SIP Trunk 4 = SIP Extension 5 = CCIS over IP 6 = NetLink	1	✓		

Program Number	Program Name/Description	Input Data	Default	Level		
				1	2	3
84-33-01	<b>FAX over IP Setup – FAX Relay Mode</b> Enable/Disable the FAX relay mode. Port mode is used to enable Fax relay per port settings in Program 15-03-03.	0 = Disable 1 = Enable 2 = Each Port Mode	0	✓		
84-33-12	<b>FAX Over IP Setup – FAX Codec</b> Setup the Codec for Fax exchange.	1 = G.711 a-law 2 = G.711 u-law 3 = G726  Profile 1 ~ 2 (Version 2000 or lower) Profile 1 ~ 6 (Version 3000 or higher)	2 = US 1 = other		✓	
84-33-13	<b>FAX Over IP Setup – Payload Size</b> Set up the payload size.	1 ~ 4 (10ms base)  Profile 1 ~ 2 (Version 2000 or lower) Profile 1 ~ 6 (Version 3000 or higher)	2 (20ms)			✓
84-33-14	<b>FAX Over IP Setup – Jitter Buffer Mode</b> Static mode will use value defined in average jitter buffer. Self-adjusting automatically adjusts values between minimum and maximum jitter buffers defined.	1 = Static 2 = Self Adjusting  Profile 1 ~ 2 (Version 2000 or lower) Profile 1 ~ 6 (Version 3000 or higher)	1			✓
84-33-15	<b>FAX Over IP Setup – Minimum Jitter Buffer</b> Setup FAX over IP Codec settings when using CCIS over IP.	0 ~ 300  Profile 1 ~ 2 (Version 2000 or lower) Profile 1 ~ 6 (Version 3000 or higher)	80			✓
84-33-16	<b>FAX Over IP Setup – Average Jitter Buffer</b> Setup FAX over IP Codec settings when using CCIS over IP.	0 ~ 300  Profile 1 ~ 2 (Version 2000 or lower) Profile 1 ~ 6 (Version 3000 or higher)	120			✓
84-33-17	<b>FAX Over IP Setup – Maximum Jitter Buffer</b> Setup FAX over IP Codec settings when using CCIS over IP.	0 ~ 300  Profile 1 ~ 2 (Version 2000 or lower) Profile 1 ~ 6 (Version 3000 or higher)	160			✓

Program Number	Program Name/Description	Input Data	Default	Level		
				1	2	3
84-33-18	<b>FAX Over IP Setup – RTP Payload Type</b> Set the payload number of the Codec selected in Program 84-13-12.	0, 2, 8, 96 ~ 127  Profile 1 ~ 2 (Version 2000 or lower) Profile 1 ~ 6 (Version 3000 or higher)	103		✓	
84-33-19	<b>FAX Over IP Setup – FAX over IP Type</b> Select FAX over IP type. Type 1 (T.38 relay mode): SV9100 original mode Type 2 (Pass-Through mode): PBX compatible mode If Type 2 is selected, FAX over IP feature is executed using Program 84-33 settings.	1 = Type 1 2 = Type 2  Profile 1 ~ 2 (Version 2000 or lower) Profile 1 ~ 6 (Version 3000 or higher)	1	✓		

◇ If Program 84-33-01 is disabled, Programs 84-33-12 ~ 84-33-19 are not valid. Also, Program 84-33 index must be set to SIP Trunk.

## Operation

None

## *SIP Trunk Keep Alive using OPTION message*

### Description

The SV9100 provides support for SIP Trunk Keep Alive using the OPTION message for all six SIP Profiles, applicable to both IP System Interconnection and SIP Carrier mode.

#### Conditions

- OPTION Keep Alive is supported for all SIP carrier types (Program 10-29-14).
- Program 10-29-19 must be set to 1 (Enabled) to make OPTION Keep Alive function for SIP Carrier mode.
- Program 10-23-05 must be set to 1 (Enabled) to make OPTION Keep Alive function for IP system Interconnection mode.
- SV9100 sends the OPTION message at the interval set in Program 84-14-18.
- OPTION Keep Alive can be sent to the SIP carrier or IP system Interconnection of the NetLink Secondary System.
- OPTION Keep Alive Call Restriction and Alarm of the NetLink Secondary System are not supported.
- If SV9100 does not receive the 200-OK response from the SIP server, the SV9100 will retry sending the OPTION message for 32 seconds.

#### Default Setting

None

### System Availability

#### Terminals

None

#### Trunks

SIP Trunks

#### Application

None

## Required Component(s)

GPZ-IPLE

0413 – SV9100 Version Lic (R3)

0300 – SV9100 Resource Lic

5103 – SV9100 IP Resource Lic

5001 – SV9100 IP Trunk Lic

## Related Features

None

## Guide to Feature Programming

The **Level 1**, **Level 2** and **Level 3** columns indicate the programs that are assigned when programming this feature in the order they are most commonly used. These levels are used with PCPro and WebPro wizards for feature programming.

- Level 1 – these are the most commonly assigned programs for this feature.
- Level 2 – these are the next most commonly assigned programs for this feature.
- Level 3 – these programs are not often assigned and require an expert level working knowledge of the system to be properly assigned.

Program Number	Program Name/Description	Input Data	Default	Level		
				1	2	3
10-23-05	<b>SIP System Interconnection Setup – Keep Alive Mode for SIP</b> Enable/Disable OPTION Keep Alive mode for IP system interconnection.	0 = Disable 1 = Enable	0	✓		
10-23-06	<b>SIP System Interconnection Setup – SIP Profile</b> Assign the Interconnection to a SIP profile.	Version 3000 or higher CPU software: 1 = Profile 1 2 = Profile 2 3 = Profile 3 4 = Profile 4 5 = Profile 5 6 = Profile 6 ➤ <i>With Version 2000 or lower CPU software, only two SIP profiles are supported.</i>	1	✓		



Program Number	Program Name/Description	Input Data	Default	Level		
				1	2	3
10-29-19	<b>SIP Server Information Setup – Keep Alive by OPTION Message</b> Enable/Disable support of Keep Alive by OPTION message for SIP carrier mode.	0 = Disable 1 = Enable Profile 1 ~ 2 (Version 2000 or Lower) Profile 1 ~ 6 (Version 3000 or Higher)	0	✓		
84-14-18	<b>SIP Trunk Basic Information Setup – Keep Alive by OPTION Interval Timer</b> Define keep alive by OPTION interval Timer. ➡ <i>The SV9100 .sends the OPTION message at the interval of the value set in this program.</i>	60 ~ 3600sec Profile 1 ~ 2 (Version 2000 or Lower) Profile 1 ~ 6 (Version 3000 or Higher)	180sec		✓	
84-14-19	<b>SIP Trunk Basic Information Setup – Keep Alive by OPTION Fail Limit</b> Define Keep Alive by OPTION fail limit	1 ~ 5 Profile 1 ~ 2 (Version 2000 or Lower) Profile 1 ~ 6 (Version 3000 or Higher)	1		✓	
84-14-20	<b>SIP Trunk Basic Information Setup – OPTION Keep Alive User ID</b> Define Keep Alive by OPTION User ID which is set in SIP URL of OPTION message.	Maximum of 32 characters Profile 1 ~ 2 (Version 2000 or Lower) Profile 1 ~ 6 (Version 3000 or Higher)	Ping		✓	

## Operation

None

## IP Video Doorphone

### Description

The IP Video Doorphone (IP3NE-IPCDH) can be connected to SV9100 system through a PoE Data Switch and is normally used to monitor an entrance door. When pressed, the Doorphone sends a chime tone to all extensions programmed to receive the chime. To answer, the called extension user just lifts the handset. This lets the extension user talk to the visitor at the Doorphone location. In addition, a user can view the outside image using the DR-viewer application (installed on a PC in the same network) or the image can be viewed using a Polycom IP VVX 1500 terminal.

Each Doorphone has a **Normally Opened** and a **Normally Closed** relay contact that can be used to connect to the electric door strike. These contacts are used to remotely control the entrance door. After answering the chimes, a Multiline Terminal user can press the Recall key and activate the Doorphone contacts. This in turn releases the electric strike on the entrance door.

The following table lists the minimum requirement necessary when installing the DR-Viewer on a PC.

*Table 2-75 DR-Viewer Requirements*

OS		Windows XP (Professional SP3)	Windows 7 (Professional) (Professional SP1)
CPU	Minimum	2.0 GHz 32bits CPU or more	
	Recommended	Single Core	3.0 GHz 32bits CPU or more
		Dual Core	1.6 GHz 32bits CPU or more
Memory	Minimum	512MB (Minimum)	1GB (Minimum)
	Recommended	1GB (Minimum)	2GB (Minimum)
Disk Space		200MB (Minimum) ➤ <i>Additional disk space is required for OS to function.</i> ➤ <i>When the log storage term is for one month.</i>	

- *Windows XP Professional 32 bit with SP3 and Windows 7 Professional 32 bit or 64 bit with SP1 are the only Operating Systems supported.*
- *If multiple LAN interfaces are installed, only the interface between the IP Video Doorphone and PC are active.*
- *There is no recording function in the DR-Viewer.*
- *Voice Transmission is not supported from a PC.*
- *If using Windows 7, the UAC function must be disabled.*
- *When using Windows 7, installation must be performed by the System Administrator.*

## Conditions

- The IP Video Doorphone does not require a license to operate.
  - ◇ *Under normal circumstances a third party SIP telephone with video would require the following:*
    - 5111 – IP Terminal Advanced
    - 0040 – SIP Video



NOTE

*The IP Video Doorphone does not require these licenses.*

- The IP Video Doorphone requires installation of the GPZ-IPLE unit and SIP Extension port.
- The door unlock device is controlled by a built-in relay contact in the IP Video Doorphone.
- For the DR-Viewer software to view the outside image from the IP Video Doorphone, each device (SV9100, IP Video Doorphone, and the DR-Viewer) must be connected to the same local network. Routing between the devices is not supported.
- The IP Video Doorphone does not have an internal power supply and requires a PoE Data Switch (IEEE802.3af connection).
- A 100/1000 BASE-TX Data Switch is required, otherwise errors in the transmission of Voice and Video data may occur.
- CTI control is not supported on the IP Video Doorphone.
- A maximum of eight door stations (including the normal Door box) can be connected.
- The IP Video Doorphone requires one IP extension port per Door station. An extension number is required for the setting but is not called using the extension number. Calls are placed using the Service code or function key.
- The DR-Viewer and IP Video Doorphone should be installed in the same data switch when possible. If the number of switch connections between the DR-Viewer and IP Video Doorphone is increased, the video resolution may deteriorate.
- A maximum of eight PCs (with DR-viewer installed), can be connected.
- The doorphone call can not be placed on hold using hook flash from the SLT, SIP Extension or SIP DECT.
- The Door Strike can not be controlled by the Service Code or Function key.
- The Electric Door Strike can not be operated by the VVX1500 (Polycom) Terminal.
- When a time-out occurs between the Doorphone and the system, an Error tone is heard on the Doorphone.
- When in the monitoring mode, the IP Video Doorphone cannot be called via the doorphone access code (Program 11-12-36).

## Default Settings

Disabled

## System Availability

### Terminals

IP Video Doorphone (IP3NE-IPCDH)

Polycom VVX1500

### Required Component(s)

- GPZ-IPLE Daughter Board
- IP3NE-IPCDH
- PoE Data Switch (IEEE802.3af connection)
- PC with DR-Viewer software installed
- 0411 – SV9100 Version Lic (R1)
- 0300 – SV9100 Resource Lic
- 5103 – SV9100 IP Resource Lic
- 5111 – SV9100 IP Phone Lic

## Related Features

↳ **Door Box**

## Guide to Feature Programming

The **Level 1**, **Level 2** and **Level 2** columns indicate the programs that are assigned when programming this feature in the order they are most commonly used. These levels are used with PCPro and WebPro wizards for feature programming.

- Level 1 – these are the most commonly assigned programs for this feature.
- Level 2 – these are the next most commonly assigned programs for this feature.
- Level 3 – these programs are not often assigned and require an expert level working knowledge of the system to be properly assigned.

◇ *The items highlighted in gray are read only and cannot be changed.*

Program Number	Program Name/Description	Input Data	Default	Level		
				1	2	3
10-12-09	<b>GCD-CP10 Network Setup – IP Address (VoIPDB)</b> Set the IP Address for GPZ-IPLE. ➡ <i>The IP Address assigned in Program 10-12-01 cannot start with the same leading digits as the IP Address assigned here.</i>	0.0.0.0 ~ 126.255.255.254 128.0.0.1 ~ 191.255.255.254 192.0.0.1 ~ 223.255.255.254	172.16.0.10	✓		
10-12-10	<b>GCD-CP10 Network Setup – Subnet Mask</b> Define the Subnet Mask for the VoIPDB unit.	128.0.0.0   192.0.0.0   224.0.0.0  240.0.0.0   248.0.0.0   252.0.0.0  254.0.0.0   255.0.0.0  255.128.0.0   255.192.0.0  255.224.0.0   255.240.0.0  255.248.0.0   255.252.0.0  255.254.0.0   255.255.0.0  255.255.128.0   255.255.192.0  255.255.224.0   255.255.240.0  255.255.248.0   255.255.252.0  255.255.254.0   255.255.255.0  255.255.255.128  255.255.255.192  255.255.255.224  255.255.255.240  255.255.255.248  255.255.255.252  255.255.255.254  255.255.255.255	255.255.0.0	✓		
10-12-11	<b>GCD-CP10 Network Setup – NIC Setup</b> Define the LAN interface Speed and Mode of the VoIP Application supported. ➡ <i>IPLE daughter board does not support half duplex connection.</i>	0 = Auto Detect 1 = 100Mbps, Full Duplex 3 = 10Mbps, Full Duplex 5 = 1Gbps, Full Duplex	0			✓
10-13-01	<b>DHCP Server Mode</b> Enable/Disable the built-in DHCP Server.	0 = Disable 1 = Enable	0			✓
10-19-01	<b>VoIP DSP Resource Selection</b> Select type of GPZ-IPLE DSP Resource. This program setting has no affect on the terminal/trunk port assignment or usage.	0 = Common use for both IP extensions and trunks 1 = IP Extension 2 = SIP Trunk 3 = CCIS/Networking 4 = Use for NetLink 5 = Blocked 6 = Common without Unicast Paging 7 = Multicast Paging 8 = Unicast Paging	Resource 1 = 1 Resource 2 ~ 256 = 0			✓

Program Number	Program Name/Description	Input Data	Default	Level		
				1	2	3
10-54-01	<p><b>License Configuration for Each Package – License Code</b></p> <p>Assign VoIP Resource Licenses (5103) to GCD-CP10 slot (1).</p> <p>If applying more than 255 licenses to a slot, the licenses must be applied across multiple indexes.</p> <p>For example, assigning 256 VoIP resource licenses (5103) to the CPU slot could be assigned using different methods as long as the total for the CPU slot is 256.</p> <p>1. Index 1 has 128 of feature code 5103 and index 2 also has 128 of feature code 5103 for a total of 256.</p> <p>2. Index 1 has 255 of feature code 5103 and index 2 has 1 of feature code 5103 for a total of 256.</p>	1 ~ 255 Resource Licenses	0		✓	
11-02-01	<p><b>Extension Numbering – Dial (Up to 8 Digits)</b></p> <p>Assign a maximum of eight digits for extension numbering.</p>	Maximum of eight digits.	1 101 2 102 3 103 ~ ~ 99 199 100 3101 ~ ~ 960 3961		✓	
11-10-18	<p><b>Service Code Setup (for System Administrator) – Off-Premise Call Forward by Door Box</b></p> <p>Set the service code for setting automatic transfer for ISDN/SIP.</p>	722	722			✓
11-12-36	<p><b>Service Code Access (for Service Access) – Door Box Access</b></p> <p>Assign the access code used to call the doorphone.</p>	702	702			✓
15-05-01	<p><b>IP Telephone Terminal Basic Data Setup – Terminal Type</b></p> <p>Set the terminal type for each extension.</p> <p>When connecting IP Video Doorphone 2 (SIP) is displayed.</p>	1 = H.323 2 = SIP 3 = None 4 = DT800/DT700	0			✓
15-05-43	<p><b>IP Telephone Terminal Basic Data Setup – Video Mode</b></p> <p>This program Enables/Disables Standard SIP phones video functionality.</p>	0 = Disable 1 = Enable	0	✓		
15-05-46	<p><b>IP Telephone Terminal Basic Data Setup – Doorphone Number</b></p> <p>If the port assignment of the Doorphone is successful, a Doorphone number is automatically entered.</p>	0 = Not Assigned 1 ~ 8 = Doorphone Number	0			✓

Program Number	Program Name/Description	Input Data	Default	Level		
				1	2	3
15-07-01	<b>Programmable Function Keys</b> Assign a function key for External Call Forward by Doorphone (Code 54) and Doorphone Access (Code 97).	Line Key 1 ~ 48 0 ~ 99 (Normal Function Code 751 by default) *00 ~ *99 (Appearance Function Code) (Service Code 752 by default)	Refer to the Programming Manual for default values.		✓	
20-15-07	<b>Ring Cycle Setup – Door Box Ringing for SLT</b> Define the ringing cycle for Door Box Ringing for SLT terminals.	Ring Cycle = 1 ~ 13	8			✓
32-01-01	<b>Door Box Timers – Door Box Answer Time</b> Set the time a user has to answer the Door Box chimes.	0 ~ 64800 seconds	30		✓	
32-01-03	<b>Door Box Timers – Off-Premise Call Forward by Door Box Disconnect Timer</b> Define the conversation time for an Off-Premise Call Forward by Door Box call. When this timer expires, the caller hears busy tone for 3 seconds (fixed time), and the call is then disconnected.	0 ~ 64800 seconds	60		✓	
32-02-01	<b>Door Box Ring Assignments</b> Determine which Door Box should ring which extension by entering the extension number. Each Door Box can be programmed to ring up to 32 extensions and an extension can be programmed to ring for multiple Door Boxes. ➡ <i>A minimum of one extension assigned is required to setup the IP Video Doorphone.</i>	Maximum of eight digits.	No Setting	✓		
32-03-01	<b>Door Box Basic Setup – Chime Pattern</b> Set the chime pattern (0 ~ 6) for each Door Box.	0 = None 1 = Door Box Ring 1 2 = Door Box Ring 2 3 = Door Box Ring 3 4 = Door Box Ring 4 5 = Door Box Ring 5 6 = Door Box Ring 6	Door Box 1 = 1 Door Box 2 = 2 Door Box 3 = 3 Door Box 4 = 4 Door Box 5 = 5 Door Box 6 = 6 Door Box 7 = 1 Door Box 8 = 1		✓	
32-04-01	<b>Door Box Name Setup – Door Box Name</b> Define the name of each Doorphone.	Maximum of 12 characters.	No Setting		✓	
84-19-01	<b>SIP Extension CODEC Information Basic Setup – Number of G.711 Audio Frames</b> Define the G.711 audio frame size.	1 ~ 4 1 = 10ms 2 = 20ms 3 = 30ms 4 = 40ms	2			✓
84-19-03	<b>SIP Extension CODEC Information Basic Setup – G.711 Type</b> Define the G.711 Type – $\mu$ -law is recommended when in USA.	0 = A-law 1 = $\mu$ -law	1			✓

Program Number	Program Name/Description	Input Data	Default	Level		
				1	2	3
84-20-01	<b>SIP Extension Basic Information Setup – Registrar/Proxy Port</b> Define SIP station Proxy Port.	1 ~ 65535	5070		✓	
84-26-01	<b>IPL Basic Setup – IP Address</b> Assign the IP address for the DSP on the GPZ-IPLE.	xxx.xxx.xxx.xxx	172.16.0.20	✓		
90-23-01	<b>Deleting Registration of IP Telephones – Delete IP Telephone</b> When deleting the registration, the Doorphone number in Program 15-05-46 is deleted at the same time. ➡ <i>This program is available only via telephone programming and not through PC Programming</i>	Maximum of eight digits. [Delete?]: Dial 1 + press <b>Transfer</b>			✓	

## Operation



REFERENCE

For additional information regarding the IP Video Doorphone, refer to the following manuals:

- *The UNIVERGE SV9100 IP Video Doorphone (IP3NE-IPCDH) Configuration Guide*
- *The UNIVERGE SV9100 IP Video Doorphone (IP3NE-IPCDH) DR-Viewer Installation and Configuration Guide*



## *IP/Digital Call Logging*

### Description

When using NEC DT300 and DT700 desktop terminals, telephone calls can be monitored, recorded and stored. For single phone applications, the NEC 1-Port Digital Call Logging Unit can be used. This will only support digital DT300 phone applications. For up to 16 digital ports or VoIP traffic the NEC IP/Digital Back Office call logging unit can be used.

The back bone of NEC's higher volume call recording software is the NEC IP/Digital BackOffice software which is PC based and is capable of recording calls from both VoIP (DT700) and digital (DT300) phones. NEC's BackOffice software works in conjunction with a 4-Port Digital Logging Unit for recording of TDM type calls.

IP Tap or BackOffice is used to record IP type calls. IP Tap is installed in line with the IP terminal. BackOffice relies on port mirroring to collect and process packets for the recording of IP type calls.

The 1-Port IP Call Logging Unit (IP Tap) is a USB device capable of recording SIP audio.

1. To record SIP audio, the 1-Port Call Logging Unit (IP Tap) must be installed in line with a SIP phone. Only calls sent or received on the connected SIP phone are recorded.
2. The 1-Port IP call Logging Unit (IP Tap) can be put in line with the VoIPDB to record either an extension or a SIP trunk. When recording SIP trunks, a maximum of eight trunk members can be recorded at a time, but the licenses must be present in the Call Logging Unit. This unit cannot be used with Digital or Analog phones.
3. The 1-Port IP Call Logging Unit (IP Tap) can be managed by the Player/Recorder for IP Tap, BackOffice, the Manager or Reporter Pro.

Three options are available for playing back of the recorded calls. For playback and management of recorded calls NEC offers the NEC Player/Recorder, Manager and Reporter Pro. All of these perform the playback function but offer increasing levels of additional features.

The NEC Digital Player/Recorder is used by an individual user to play back their own archive of calls or to play back NEC VSR calls stored on their PC or network. It easily manages calls from one storage location. It does not offer many of the advanced functions of the VSR Manager, such as establishing preset shortcuts to any number of storage folders for quick and easy access. The Recorder portion of this software is much like Back Office but scaled down to be utilized by the single port digital call logging unit. It allows you to set where to store calls, and how long to archive them amongst other things.

The NEC IP/Digital Manager is much like the Player, it provides advanced visibility, access, retrieval, and playback tools for the VSR Recorder administrators. It provides an intuitive interface for establishing shortcuts to any number of storage folders and allows the supervisor to search across all storage folders for specific call information such as User, Time/Date, Length of Call, etc. The application can be used to access and manage VSR recordings whether created by the single port VSR or the 4-Port Digital Call Logging Unit.

The NEC Call Logging Unit now supports licensing via LMS which in most cases can eliminate the need for a license dongle.

The NEC IP/Digital Reporter is NEC's most feature rich product for listening to recorded phone calls. It has functionality much the same as the Manager but offers additional features. These additional features make management easier by providing tools to help gather data and generate reports. NEC's IP/Digital Reporter also provides advanced features which help in gathering data and report generation of usage and performance metrics for analysis and monitoring of the call recording environment. Usage analysis provide data metrics on call volume, disk usage, average call length, longest calls, most called numbers, longest recorded time numbers, call volume distribution over date span, call volume distribution at hourly intervals and call volume distribution at call length intervals.

The use of these products is covered in greater depth in their specific User Guides.



*The use of monitoring, recording, or listening devices to eavesdrop, monitor, retrieve, or record telephone conversation or other sound activities, whether or not contemporaneous with transmission, may be illegal in certain circumstances under federal or state laws. Legal advice should be sought prior to implementing any practice that monitors or records any telephone conversation. Some federal and state laws require some form of notification to all parties to a telephone conversation, such as using a beep tone or other notification methods or requiring the consent of all parties to the telephone conversation, prior to monitoring or recording the telephone conversation. Some of these laws incorporate strict penalties.*

## Conditions

- The PC hosting Back Office should have the power save functionality disabled.
- Encryption is only supported at 256-bit setting.
- Does not support recording of VoIP phone conversations in a Netlink or CCIS configuration.
- No Wireless terminal support.
- Encryption Feature – Requires IP/Digital Call Logging Manager or Reporter for playback.
- Network Port monitoring is required for recording calls from VoIP extensions.
- Peer-to-Peer is only supported in a VoIP multi-port mirroring scenario.
- VoIP calls placed on hold or conference will break into two call recordings.
- The data switch used to monitor traffic needs to have the monitor port capable of ingress and egress simultaneously.
- Only a single NIC is supported for the PC hosting Back Office.
- A maximum of four 4-Port Digital Call Logging Units is supported.
- IP/Digital Call Logging supports the G.711 CODEC only.
- Licenses for the 1-Port IP Call Logging Unit (IP Tap) is embedded in the firmware.

## XML Call Recording Control (IP Terminals Only)

### Description

IP/Digital BackOffice Version 3.0 has been enhanced to allow for Desk Top Control support for DT700 terminals only. This feature allows the user to Start, Stop or Pause the recording function and to make recorded comments from the terminal. Management of recordings can be done with IP/Digital Manager and Reporter Pro.

### Conditions

- BackOffice is not supported with Dual NIC's.
- The Data switch must support Port Mirroring.
- The monitor port must support both Ingress and Egress traffic.
- The XML application will not function without Ingress and Egress traffic on the monitor port.
- BackOffice will not receive a license without Ingress and Egress traffic on the monitor port (SV8100 only).
- XML is only supported on DT700 (I-SIP, N-SIP) series terminals.
- IIS must **NOT** be installed on the same PC running XML BackOffice.

### Terminal Configuration

The terminal must be configured with the following settings:

- Pop up mode must be set to **App Priority**. From the terminal, login to the **Admin menu**. Select **Application Settings-> Popup-> Popup Mode**. Check the box **App Priority**.
- Push Server access must be set to **Enable (All Clients)**. From the terminal, login to the **Admin menu**. Select **Security-> Push Server-> Push Server Access**. Check the box **Enable (All Clients)**.

### PC Requirements

- PC should be dedicated for BackOffice use only.
- PC running XML BackOffice must **NOT** have IIS installed.
- Windows 7 and Windows 8 are supported.
- Windows XP is not supported.
- Firewall should be configured for inbound TCP traffic on port 80 and outbound TCP traffic on port 82. Firewall can also be disabled.
- There cannot be another Web Server running on the same PC as BackOffice.
- Confirm connection from PC to terminal TCP port 82 using "telnet [terminal-IP address] 82".

- Confirm connection to PC running XML BackOffice for another PC using “telnet [recorder-IP address] 80”.
- If either Telnet test fails the XML will not function.
- WinPcap must be installed on the PC.

### XML Windows

Displays may vary depending on the terminal type.

- If manual recording is enabled or the recording has been stopped, the following is displayed.

Figure 2-57 Start Recording



- If recording has started automatically or manually, the following is displayed.

Figure 2-58 Recording



- If the recording has been paused, the following is displayed.

Figure 2-59 Paused



- ❑ If there are no licenses installed in the BackOffice, the following will appear.

Figure 2-60 Information Screen

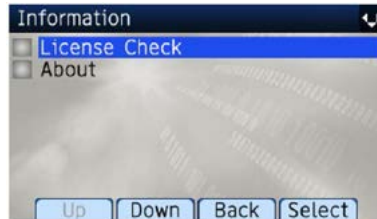

- ❑ The following screen is used when making comments. Go to **Settings**, highlight the comment during recording and click **Save**.

Figure 2-61 Comment List Screen



## Default Settings

None

## System Availability

### Terminals

NEC DT300/DT700 Series Desktop Terminals – NEC IP/Digital Call Logging

### Required Component(s)

- 4-Port Digital Call Logging Unit DT300 only)
- 1-Port Call Logging Unit (IP Tap) – XML is not supported
- PC Hardware and Software:
  - ❑ Pentium 4 processor
  - ❑ 512 Mb RAM
  - ❑ Microsoft .Net Framework 2.0+

- Data switch with managed port capabilities
- LAN connection to data switch to monitor for SIP and RTP traffic and for remote access to stored calls.
- NEC BackOffice or Recorder software
- Sufficient hard drive space for recording calls. Using the default (.xtr) format 168 hours of recording can be stored in 1 gbyte of storage space
- Windows XP or Windows 7 (32- or 64-bit)

## Related Features

None

## Guide to Feature Programming

None

## Operation

None

## ISDN Compatibility

### Description

#### ISDN-BRI

Integrated Service Digital Network – Basic Rate Interface (ISDN-BRI) is a Public Switched Telephone Network (PSTN) service that provides two B channels and a D channel (2B + D) for voice call trunking. The B channels provide two voice path connections. Caller ID is usually a standard feature on ISDN-BRI provided trunks. Caller ID indication displays the calling party telephone number on the LCD of the multiline terminal for CO incoming calls. This interface provides voice communication path only.

With ISDN BRI the SV9100 only supports the following protocol:

- National ISDN-1 (NI-1)

#### ISDN-PRI

ISDN-PRI (Integrated Service Digital Network – Primary Rate Interface) is a Public Switched Telephone Network (PSTN) service that provides 23 B channels and a single D channel (23B+1D) for trunking. Caller ID indication displays the calling party telephone number on the LCD of the multiline terminal for CO incoming calls. This interface provides voice communication path only.

With ISDN PRI the SV9100 supports the following protocols:

- NI-2
- 4ESS (AT&T Custom)
- AT&T 5ESS (Lucent Custom)
- DMS-100 Custom (Nortel Spec NIX-A211-1)
- DMS-100 National ISDN (Nortel Spec NIX-A233-1)

#### ISDN – BRI/PRI Features

- DID Line Service  
When configured for DID Line Service, the trunks emulate Loop Start or Ground Start trunks for outgoing calls and DID trunks for incoming calls.
- Calling Line Identification Presentation (CLIP)  
Program 10-03-05: ETU Configuration – CLIP Information Announcement, allows the Calling Party Number IE in the Setup Message for a call when placed out an ISDN Trunk.
- Calling Party Number (CPN) Presentation from Station  
Calling Party Number (CPN) Presentation from Station allows each unique station or virtual extension 10-digit number (representing the DID number of the originating station) to be sent out over the ISDN Network, if it is programmed. If no Extension Calling Number is assigned, the system sends the calling number for the ISDN trunk. If both the extension and trunk information are programmed, the extension information is sent as it takes priority.

- Calling Party Name**  
If programmed, Calling Party Name allows the station name to be sent out over the ISDN network. A system wide name can be programmed to be sent over the network or the name can be defined on a per station basis. If both are programmed, the system wide name takes priority over the station name.
- SMDR Includes Dialed Number**  
The SMDR report can optionally print the trunk name (entered in system programming) or the number the incoming caller dialed (i.e., the dialed ISDN digits). This allows you to analyze the SMDR report based on the number your callers dial. (This option also applies to a DID trunk.)
- Display Shows Why Caller ID is Not Available**  
With Caller ID enabled, the system provides information for ISDN calls that do not contain the Caller ID information. If the Caller ID information is restricted, the telephone display shows PRIVATE. If the system cannot provide Caller ID information because the Telco information is not available, the display shows OUT OF AREA.

## Conditions

### ○ Primary Rate Interface (PRI):

The system is compatible with ISDN Primary Rate Interface (PRI) services. PRI services currently supported include:

- Basic PRI Call Control (BCC)
- Display of incoming caller's name and number when allowed by Telco
- Routing in the system based on the number the caller dialed
- ISDN maintenance functions (such as In Service/Out of Service Messaging)
- Speech and 3.1 KHz audio

PRI ability requires the installation of GCD-PRTA. Each PRI circuit provides 24 PRI channels (23B + D) 4 with 64K Clear Channel response. The T1/PRI Interface uses a single slot. When installed, the T1/PRI Interface uses the first block of 24 consecutive trunks. For example, if you have an GCD-4COTB + GPZ-4COTF installed for trunks 1~8, the T1/PRI Interface automatically uses trunks 9~32. If you have GCD-4COTB + GPZ-4COTF installed for trunks 1~8 and 17~24, the T1/PRI uses trunks 25~48. The T1/PRI Interface cannot use trunks 9~16 (even if available) since they are not part of a consecutive block of 24 trunks.

- The sending of Calling Party Name display information to the public network with ISDN PRI is only supported with NI2 protocol.
- When using Mobile Extension in a NetLink Network, the ISDN/PRI must be utilized in the Primary System.
- When using fractional PRI, the blade comes up as zero ports until Program 10-03-06 is set to the 4/8/12/16/20/24(auto), and then reset.



- If fractional PRI has the number of ports changed, the Trunk Port number might change if they become split or fit into an empty gap of trunk ports. For example, if you have a GCD-4COTB + GPZ-4COTF for Trunks ports 1~8 and 17~24 and the PRI (12 ports) was assigned as 25~36 and the PRI is changed to be eight ports instead of 12 ports, the new trunk port numbers would be 9~16 because the eight ports can now fit into the gap without being split ports. Another example, if you have a GCD-4COTB + GPZ-4COTF for Trunks ports 1~8 and 17~24 and the PRI (8 ports) was assigned as 9~16 and then you change the PRI to be 12 ports instead of eight, the new trunk ports would be 25~36 because the ports have to be split to keep the original port numbers, and this is not supported.
- If using a CSU/DSU, Program 10-03-13 must be set to 0. If not using a CSU/DSU, Program 10-03-13 must be set to 1~7 or anything other than 0.
- Restrictions for Calling Party Name:

The UNIVERGE SV9100 supports receiving the name from the Network in supported formats only. Refer to [Table 2-57 Restrictions for Calling Party Names](#).

Table 2-76 Restrictions for Calling Party Names

Protocols	Name Delivery Formats
NI-2	Facility Information Elements
4ESS (AT&T Custom)	Not Supported
AT&T5ESS Lucent Custom	Facility Information Element
DMS-100 (Custom) *	Display Information Element *
DMS-100 (National; ISDN) **	Facility Information Element **

\* Nortel Specification NIX-A211-1

\*\* Nortel Specification NIS-A233-1

- CO Line Service is not supported
- ISDN – PRI cannot be configured for CO Emulation
- B-Channel to Trunk Association

When an Incoming ISDN-BRI/PRI call is received, the system assigns the lowest trunk number of the ISDN circuit to the incoming call associated with the B-Channel. When an Outgoing call is placed using the ISDN-PRI/BRI, the system assigns the Trunk and B-Channel association according to the chart below. This is based on the Trunk-to-Trunk Group and Trunk Group Priority assignment in (Program 14-05-01).

Refer to the charts below for examples:

**Incoming Call**

Station User →  
Talking on TK009

Trunk Number	B-Channel Number
9	1
10	2
11	3
12	4
13	5
14	6
15	7
16	8
17	9
18	10
19	11
20	12
21	13
22	14
...31	...23

← Incoming call from the Network on Channel 23. In most cases, the Network will control/select the B-Channel used for an incoming call.

**Outgoing Call**

Station user →  
places outgoing trunk call by dialing Trunk Access code. Outgoing call is placed on the associated B-Channel.

Trunk Number	Trunk Group	Trunk Priority	B-Channel Number
9	1	9	1
10	1	8	2
11	1	7	3
12	1	6	4
13	1	5	5
14	1	4	6
15	1	3	7
16	1	2	8
17	1	1	9
18	2	3	10
19	2	2	11
20	2	1	12
21	3	11	13
22	3	10	14
...31	3	...1	...23

➡ In addition to T1/PRI interface ETUs, PRI also requires a CSU/DSU Unit and interconnecting cables to interface with the Telco.

- Basic Rate Interface (BRI)

Caller ID Name to Single Line Telephone is *NOT* supported for ISDN (BRT) Trunks.

The system is compatible with ISDN Basic Rate Interface (BRI) services. BRI services currently supported include:

- Basic BRI Call Control (BCC)
- Point-to-Point BRI Terminal Connection (no daisy-chaining)
- Multipoint BRI Terminal Connection (daisy-chaining)

BRI services require the installation of GCD-2BRIA. Each GCD-2BRIA has two BRI circuits. The GCD-2BRIA uses a single universal slot.



NOTE

*A GPZ-2BRIA daughter board can be added to the GCD-2BRIA to add two more BRI circuits for a total of 4.*

For each BRI line, two different Terminal Endpoint Identifiers (TEIs) are assigned to two different Service Profile Identifiers (SPIDs).

The two different SPIDs for each BRI line, are related to different trunk logical port numbers. One BRI provides two trunk logical ports when it is connected to a CO line. Each SPID is assigned to a different TEI. This relationship is made in the initialization of the BRI line when it is connected to the CO.

This relationship between SPID and TEIs are created as follows.

LOGICAL-PORT-NUMBER + 0 = SPID-1

LOGICAL-PORT-NUMBER + 1 = SPID-2

When using the SMDR reports for BRI, all incoming BRI calls are displayed under the CLASS column as IVIN.

- When using Mobile Extension in a NetLink Network, the ISDN/PRI must be utilized in the Primary System.
- Automatic Data Link Failure Recovery

If a data link error is detected by the BRI ETU, the system tries to recover the data link and send the SPID to the central office. To provide this enhancement, the BRI ETU must be able to indicate to the system when a data link error has occurred.

*In addition to the BRI Interface ETU, BRI Services require the installation of NT1 Network Terminators and interconnecting cabling.*

- CO Line Service is not supported.

ISDN–BRI cannot be configured for CO Emulation.

- BRI and DID Callers with Non-Matching SPID Numbers

This feature allows you to determine whether the system checks the called party number with the SETUP message and the SPID setup. Depending on the system programming, this can allow DID calls to be received on BRI trunks and direct them according to the DID Translation Table (Program 22-11).

- Special Conditions Related to Ordering DID Service For ISDN-BRI

Telcos may refer to this in different ways. The reference Verizon uses to order such service is Additional Directory Numbers with no new terminating equipment (only a dialable number). When you want Additional Directory Numbers to hunt when a B-Channel is busy, the service may be called Busy Diversion.

- Calling Party Number (CPN) presentation from station is available for virtual extensions.

- SV9100 supports only National ISDN-1.

- The trunk setting (Program 20-19-09) for sending the caller name on outgoing ISDN calls takes priority over the same setting for the station (Program 15-01-01).

- When programmed, Calling Party Name will be sent on calls that originate from a station (MLT, SLT, or IP Multiline) or an incoming trunk (Analog, ISDN, or CCIS).

- Calling Party Name supports up to 12 ASCII characters.

- When a call originates from a virtual extension, the Calling Party Name for the virtual extension is sent. It does not follow the setting in Program 15-18-02.

- Calling Party Name is dependent upon the carrier. The network carrier must allow the SV9100 to edit the Calling Party Name information.

- SV9100 does not support ISDN sub-addressing.

- SV9100 does not support ISDN Network Specific Parameters for the AT&T protocol such as SDN (Software Defined Network, also known as Virtual Private Network), Megacom, and Megacom800.

## ISDN 2 B-Channel Transfer

### Description

This ISDN PRI 2 B-Channel Transfer feature allows the UNIVERGE SV9100 to receive a call on one B-Channel and transfer it back out on a second B-Channel (Trunk-to-Trunk transfer on the telco side). When the transferred call connects, both of the B-Channels are then released and available for either making or receiving another call. This feature provides more efficient use of B Channels on an ISDN PRI by allowing a customer to transfer calls without tying up their B Channels for the duration of the call.

### Conditions

- The bearer capability of two calls must be “Speech, 3.1-kHz Audio, Unrestricted Digital Information” or compatible.
- This feature is not supported with Automatic Transfer.
- This feature is not supported with Unsupervised Conference.
- This feature is only supported with a Manual Transfer.
- This feature is only supported when both trunks are ISDN/PRI and the bearer capability of the two trunks meet the same service requirements.
- Trunk-to-Trunk programming must be enabled for this feature to work.
- Both ISDN/PRI trunks must reside in the same system for this feature to work.
- This feature is available if the Telco Service Provider supports this feature.
- This feature is available in the following case:

At least one call to be transferred is:

- answered (*outgoing* from the SV9100)
- answered (*incoming* to the SV9100)

And the other call is:

- answered (*outgoing* from the SV9100)
- answered (*incoming* to the SV9100)

### Default Settings

None

## System Availability

### Terminals

All Terminals

### Required Component(s)

To provide ISDN-PRI trunk connection:

- GCD-PRTA

To provide ISDN-BRI trunk connection:

- GCD-2BRIA or GCD-2BRIA with GPZ-2BRIA
- NT-1 for each BRI (locally provided)

## Related Features

- ↳ **Central Office Calls, Answering**
- ↳ **Central Office Calls, Placing**
- ↳ **Direct Inward Dialing (DID)**
- ↳ **Direct Inward Line (DIL)**
- ↳ **E-911 Compatibility**
- ↳ **Forced Trunk Disconnect**
- ↳ **Programmable Function Keys**
- ↳ **Station Message Detail Recording**
- ↳ **Transfer**

## Guide to Feature Programming

The **Level 1**, **Level 2** and **Level 3** columns indicate the programs that are assigned when programming this feature in the order they are most commonly used. These levels are used with PCPro and WebPro wizards for feature programming.

- Level 1 – these are the most commonly assigned programs for this feature.
- Level 2 – these are the next most commonly assigned programs for this feature.
- Level 3 – these programs are not often assigned and require an expert level working knowledge of the system to be properly assigned.

**ISDN – BRI Installation:**

Program Number	Program Name/Description	Input Data	Default	Level		
				1	2	3
10-03-01	<b>ETU Setup (BRIA PKG) – ISDN Line Mode</b> Set up and confirm the Basic Configuration data for each GCD-2BRIA. Use this program to select the ISDN Line Mode.	0 = Not Used 1 = T-Point	1	✓		
10-03-03	<b>ETU Setup (BRIA PKG Setup) – Connection Type</b> Set up and confirm the Basic Configuration data for each GCD-2BRIA. Confirm the connection type for each GCD-2BRIA.	0 = Point-to-Multipoint 1 = Point-to-Point	0	✓		
10-03-04	<b>ETU Setup (BRIA PKG Setup) – Layer 3 Timer Type</b> Set up and confirm the Basic Configuration data for each GCD-PRTA. This program selects the Layer 3 timer type (1 ~ 5). Each timer value of Layer 3 is set up for each type in Program 81-06 (T-Bus).	1 ~ 5	1	✓		
10-03-08	<b>ETU Setup (BRIA PKG Setup) – Dial Sending Mode</b> Select ISDN protocol.	0 = Enblock Sending 1 = Overlap Sending	1	✓		
10-03-09	<b>ETU Setup (BRIA PKG Setup) – Dial Information Element</b> Select ISDN Protocol if Overlap Sending is selected in Program 10-03-08.	0 = Keypad Facility 1 = Called Party Number	0	✓		
10-03-13	<b>ETU Setup (PRTA PKG Setup) – Loss of Signal Detection Limit</b> If the transmit/receive voltage is less than the setting in Program 10-03-13, the system considers this as Loss-Of-Signal and the PRI does not come up. Note that there are different values based on the setting in Program 10-03-12 for the PRI.	0 = Level 0 (lowest sensitivity) 1 = Level 1 2 = Level 2 3 = Level 3 4 = Level 4 5 = Level 5 6 = Level 6 7 = Level 7 (highest sensitivity)	2	✓		
10-06-01	<b>ISDN BRI Setup – TEI Selection</b> Select the method the system uses when assigning Terminal Endpoint Identifier (TEI) values to the BRI Circuit.	0 = Select by SPID number 1 = Select by Channel ID Number	0		✓	
10-06-02	<b>ISDN BRI Setup – DID Mode</b> Select the method the system uses when assigning DID Mode to the BRI Circuit.	0 = Route by Called Party Number 1 = Route by Redirecting Number	0		✓	
10-06-03	<b>ISDN BRI Setup – SPID 1</b> Assign the SPID Number for B-Channel 1.	Dial (Maximum of 20 digits).	No Setting		✓	
10-06-04	<b>ISDN BRI Setup – SPID 2</b> Assign the SPID Number for B-Channel 2.	Dial (Maximum of 20 digits).	No Setting		✓	

Program Number	Program Name/Description	Input Data	Default	Level		
				1	2	3
14-01-36	<b>Basic Trunk Data Setup – Sending Caller Name on Outgoing Calls (ISDN Trunk)</b> Disable/Enable sending the Caller Name on outgoing ISDN trunks.	0 = Disable 1 = Enable	0	✓		
15-01-10	<b>Basic Extension Data Setup – Sending Caller Name on Outgoing Calls (ISDN Trunk)</b> Disable/Enable sending the Caller Name on outgoing ISDN calls per station.	0 = Disable 1 = Enable	0	✓		
20-19-09	<b>System Options for Caller ID – Calling Party Name for ISDN Trunk</b> Enter the Calling Party Name to be used system wide for outgoing ISDN calls. If no data is entered, it will follow the station name in Program 15-01-01.	Maximum of 12 characters.	No Setting	✓		
21-12-01	<b>ISDN Calling Party Number Setup for Trunks – Calling Party Number Data</b> Assign Calling Party Numbers for each trunk (maximum 16 digits per entry). ➡ After the above programming is complete a reset of the GCD-2BR1A is required.	Maximum of 16 characters (1 ~ 0, *, #)	No Setting		✓	

**ISDN – PRI Installation:**

Program Number	Program Name/Description	Input Data	Default	Level		
				1	2	3
10-03-04	<b>ETU Setup (PRTA PKG Setup) – Layer 3 Timer Type</b> Set up and confirm the Basic Configuration data for each CD-PRTA This program selects the Layer 3 timer type (1 ~ 5). Each timer value of Layer 3 is set up for each type in Program 81-06 (T-Bus).	1 ~ 5	1	✓		
10-03-06	<b>ETU Setup (PRTA PKG Setup) – Length of Cable</b> Set up and confirm the Basic Configuration data for each GCD-PRTA. Select the length of cable to be used.	0 = Level 1 1 = Level 2 2 = Level 3 3 = Level 4 4 = Level 5	2	✓		
10-03-08	<b>ETU Setup (PRTA PKG Setup) – Dial Sending Mode</b> ISDN protocol definition. Select either enblock or overlap sending.	0 = Enblock Sending 1 = Overlap Sending	0	✓		



Program Number	Program Name/Description	Input Data	Default	Level		
				1	2	3
10-03-09	<b>ETU Setup (PRTA PKG Setup) – Dial Information Element</b> ISDN protocol definition. If Overlap Sending is selected in Program 10-03-08, select either 0 or 1 for the dial information element.	0 = Keypad Facility 1 = Called Party Number	0	✓		
10-03-18	<b>ETU Setup (PRTA PKG Setup) – Type of Number</b> Select the number type for the ISDN circuit.	0 = Unknown 1 = International number 2 = National number 3 = Network Specific number 4 = Subscriber number 5 = Abbreviated number	2	✓		
10-03-19	<b>ETU Setup (PRTA PKG Setup) – Numbering Plan Identification</b> Select the Numbering Plan used for the ISDN circuit.	0 = Unknown 1 = ISDN numbering plan 2 = Data numbering plan 3 = Telex numbering plan 4 = National standard numbering plan 5 = Private numbering plan	1	✓		
10-03-20	<b>ETU Setup (PRTA PKG Setup) – Network Exchange Selection</b> Select the ISDN protocol for the ISDN circuit.	0 = Standard (Same as NI-2) 1 = reserved 2 = reserved 3 = DMS (A211) 4 = 5ESS 5 = DMS (A233) 6 = 4ESS 7 = NI-2	0	✓		
10-03-21	<b>ETU Setup (PRTA PKG Setup) – PRI Number of Ports</b> Select the number of ports for the PRI.	0 = Auto 1 = 4 Ports 2 = 8 Ports 3 = 12 Ports 4 = 16 Ports 5 = 20 Ports	0	✓		
10-39-01	<b>Fractional Setup</b> Enable/Disable the T1/PRI fractional function.	0 = Disable 1 = Enable	0	✓		
14-05-01	<b>Trunk Group – Trunk Group Number</b> Assign trunks to trunk groups then go to Program 14-06-01 below to set up Trunk Group Routing.	Trunk Port 1 ~ 400 Group Number 0 ~ 100 Priority 1 ~ 400	Default = Trunks 1 ~ 400 assigned to trunk group 1 with priorities equal to the trunk number. Trunk 1 = Priority 1 Trunk 400 = Priority 400.	✓		
21-01-03	<b>System Options for Outgoing Calls – Trunk Interdigit Time (External)</b> The time the system waits for the timer to expire before placing the call in a talk state.	0 ~ 64800 seconds	5		✓	

Program Number	Program Name/Description	Input Data	Default	Level		
				1	2	3
21-12-01	<p><b>ISDN Calling Party Number Setup for Trunks – Calling Party Number Data</b></p> <p>Assign Calling Party Numbers for each trunk (maximum 16 digits per entry).</p> <p>➡ After the above programming is complete a reset of the GCD-PRTA is required.</p>	Maximum of 16 characters (1 ~ 0, *, #)	No Setting		✓	

**DID Services for either ISDN – BRI or PRI:**

Program Number	Program Name/Description	Input Data	Default	Level		
				1	2	3
22-02-01	<p><b>Incoming Call Trunk Setup</b></p> <p>Assign the incoming trunk type for each trunk.</p>	Trunks 1 ~ 400 0 = Normal 1 = VRS (second dial tone if no VRS installed) 2 = DISA 3 = DID 4 = DIL 5 = E&M Tie line 6 = Delayed VRS 7 = ANI/DNIS 8 = DID(DDI) Mode Switching	0		✓	
22-09-01	<p><b>DID Basic Data Setup – Expected Number of Digits</b></p> <p>For each DID Translation Table (1 ~ 20), enter the number of digits the table expects to receive from the CO (eight maximum). For example, for a table used with 3-digit DID service, enter 3. For additional DID Services refer to <a href="#">Direct Inward Dialing (DID)</a> on page 2-418.</p>	1 ~8	4	✓		
22-11-01	<p><b>DID Translation Number Conversion – Received Number</b></p> <p>For each DID Translation Table entry (1 ~ 4000), specify the digits received by the system.</p>	Maximum of eight digits.	No Setting	✓		
22-11-02	<p><b>Translation Number Conversion – Target Number</b></p> <p>For each DID Translation Table entry (1 ~ 4000), specify the extension the system dials after translation.</p>	Maximum of 24 digits.	No Setting	✓		

**Calling Party Number Presentation for either ISDN – BRI or PRI:**

Program Number	Program Name/Description	Input Data	Default	Level		
				1	2	3
10-03-05	<p><b>ETU Setup (PRTA PKG Setup) – CLIP Information</b></p> <p>Based on this setting, the system includes Presentation Allowed (1) or Presentation Restricted (0) in the Setup message to allow or deny the Calling Party Number. Program 15-01-04 must also be set to 1 if this option is enabled.</p>	<p>0 = Disable 1 = Enable</p>	1	✓		
15-01-04	<p><b>Basic Extension Data Setup – ISDN Caller ID</b></p> <p>If Program 15-01-04 and Program 10-03-05 are enabled, the system includes Caller ID in the Setup message as Presentation Allowed. If these options are disabled, it is Presentation Restricted.</p>	<p>0 = Disable 1 = Enable</p>	1		✓	
20-06-01	<p><b>Class of Service for Extensions</b></p> <p>Assign a Class of Service (1 ~ 15) to an extension.</p>	<p>Day Night/Mode: 1 ~ 8 Class of Service of Extensions (1 ~ 15)</p>	<p>Extension port 101 = Class 15 All other extension port = Class 1</p>		✓	
20-08-13	<p><b>Class of Service Options (Outgoing Call Service) – ISDN CLIP</b></p> <p>Determine if the ISDN calling line identity presentation and screening indicators should be allowed.</p>	<p>0 = Off 1 = On</p>	0		✓	
21-12-01	<p><b>ISDN Calling Party Number Setup for Trunks</b></p> <p>Assign Calling Party Numbers for each trunk (maximum 16 digits per entry). When a call is made by an extension which does not have an Extension Calling Number assigned (Program 21-13), the system sends the calling number for the ISDN trunk defined in 21-12. If the Calling Party Number is assigned in both Program 21-12 and Program 21-13, the system sends the data in Program 21-13.</p>	<p>Maximum of 16 characters (1 ~ 0, *, #)</p>	No Setting		✓	
21-13-01	<p><b>ISDN Calling Party Number Setup for Extensions</b></p> <p>Assign a Calling Party Number (maximum 16 digits per entry) to each extension. The calling number is the subscriber number of the dial-in number. When a call is made by an extension which does not have an Extension Calling Number assigned (Program 21-12), the system sends the calling number for the ISDN trunk defined in Program 21-13. If a Calling Party Number is assigned in both Program 21-12 and Program 21-13, the system sends the data in Program 21-13.</p>	<p>Maximum of 16 characters (0 ~ 9, *, #)</p>	No Setting		✓	

### ISDN – PRI Network Specific Assignment:

Program Number	Program Name/Description	Input Data	Default	Level		
				1	2	3
26-02-07	<b>Dial Analysis Table for ARS/LCR – Network Specified Parameter Table</b> Define the network specified parameter table for each ARS Table.	0 ~ 16	0		✓	
26-12-01	<b>Network Specific Parameter Table for ARS – Type of Number</b> Define the type of Number parameter for an ISDN outgoing call.	0 = System Default 1 = Unknown 2 = International No. 3 = National No. 4 = Network Specific No. 5 = Subscriber No. 6 = Abbreviated No.	0		✓	
26-12-02	<b>Network Specific Parameter Table for ARS – Numbering Plan Identification</b> Define the Numbering Plan Identification Parameter for an ISDN outgoing call.	0 = System Default 1 = Unknown 2 = ISDN Plan 3 = Data Plan 4 = Telex Plan 5 = National Standard Plan 6 = Private Plan	0		✓	
44-05-11	<b>ARS/F-Route Table – Network Specified Parameter Table</b> Define the network specified parameter table for each F-Route table.	0 ~ 16	0		✓	

### SMDR Dialed Digits for either ISDN – BRI or PRI:

Program Number	Program Name/Description	Input Data	Default	Level		
				1	2	3
35-02-15	<b>SMDR Output Options – CLI/DID Number Switching</b> Determine if the CLI/DID Number should be displayed.	0 = CLI (CLIP) 1 = DID Calling Number 2 = Caller ID Name	0		✓	
35-02-16	<b>SMDR Output Options – Trunk Name or Received Dialed Number</b> Determine how the SMDR should print incoming calls on ANI/DNIS or DID trunks. If set to 1, ANI/DNIS trunks can print DNIS digits, if set to 0 trunk names are printed instead. ➡ For additional SMDR Services refer to <a href="#">Station Message Detail Recording on page 2-1489</a> .	0 = Trunk Port Name 1 = Received Dialed Number	0		✓	

**General ISDN Programs:**

Program Number	Program Name/Description	Input Data	Default	Level		
				1	2	3
14-01-13	<b>Basic Trunk Data Setup – Trunk-to-Trunk Transfer</b> For each trunk that should be able to participate in a tandem call, enter 1. To disable a trunk from Tandem Trunking, enter 0. Required for 2 B-Channel transfer.	0 = Disable 1 = Enable	1		✓	
15-02-29	<b>Multiline Telephone Basic Data Setup – PB Back Tone Level</b> Adjust the PB Back Tone level when calling an ISDN line.	1 ~ 63 (-15.5dB ~ +15.5dB)	32 (0dB)			✓
15-07-01	<b>Programmable Function Keys</b> Assign a function key for Caller ID Block for ISDN (63) if required.	Line Key 1 ~ 48 0 ~ 99 (Normal Function Code 751 by default) *00 ~ *99 (Appearance Function Code) (Service Code 752 by default)	Refer to the Programming Manual for default values.	✓		
20-06-01	<b>Class of Service for Extensions</b> Assign a Class of Service to extensions.	Day Night/Mode: 1 ~ 8 Class of Service of Extensions (1 ~ 15)	Extension port 101 = Class 15 All other extension port = Class 1		✓	
20-09-02	<b>Class of Service Options (Incoming Call Service) – Caller ID Display</b> Turn Off or On the Caller ID display at an extension.	0 = Off 1 = On	COS 1 ~ 15 = 0		✓	
20-09-03	<b>Class of Service Options (Incoming Call Service) – Sub Address Identification</b> Define whether or not an extension displays the Caller Sub-Address.	0 = Deny 1 = Allow	COS 1 ~ 15 = 0		✓	
20-11-11	<b>Class of Service Options (Hold/Transfer Service) – Automatic On-Hook Transfer</b> Turn Off or On an extension user ability to transfer when the user hangs up.	0 = Off 1 = On	COS 1 ~ 15 = 0		✓	
20-11-14	<b>Class of Service Options (Hold/Transfer Service) – Trunk-to-Trunk Transfer Restriction</b> Turn Off or On the Trunk-to-Trunk Transfer Restriction. If enabled, Trunk-to-Trunk Transfer is impossible.	0 = Off 1 = On	COS 1 ~ 15 = 0		✓	
20-11-21	<b>Class of Service Options (Hold/Transfer Service) – Restriction for Tandem Trunking on Hang Up</b> Allow an extension user to set up a tandem call automatically when they hang up.	0 = Deny 1 = Allow	COS 1 ~ 15 = 0		✓	

Program Number	Program Name/Description	Input Data	Default	Level		
				1	2	3
20-13-23	<b>Class of Service Options (Supplementary Service) – Display the Reason for Transfer</b> Select whether or not an extension should display the reason a call is being transferred to their extension (Call Forward Busy, Call Forward No Answer, DND).	0 = Off 1 = On	COS 1 ~ 15 = 0		✓	
20-19-04	<b>System Options for Caller ID – Wait Facility IE Timer</b> This is the time an ISDN trunks uses to determine the time the system waits for the Caller ID name from the Telco.	0 ~ 64800 seconds	10			✓
20-25-14	<b>ISDN Options – No response Release Send</b> Operation mode setting for when second T303 timer expires.	0 = Off 1 = On	0			✓

**ISDN 2 B-Channel Transfer:**

Program Number	Program Name/Description	Input Data	Default	Level		
				1	2	3
10-03-16	<b>ETU Setup – PRI Service Two B-Channel Transfer</b> Turn On or Off the ability to use the ISDN-PRI 2 B-Channel Transfer service.	0 = Off 1 = On	0	✓		
14-01-13	<b>Basic Trunk Data Setup – Trunk-to-Trunk Transfer</b> If DISA caller can place outgoing calls through the system (refer to Program 20-14), Enable loop supervision for the DISA trunk. If DISA caller cannot use the system trunks for outgoing calls, enter Disable.	0 = Disable 1 = Enable	2	✓		
15-07-01	<b>Programmable Function Keys</b> Assign function to multiline terminal line keys (Transfer = 06).	Line Key 1 ~ 48 0 ~ 99 (Normal Function Code 751 by default) *00 ~ *99 (Appearance Function Code) (Service Code 752 by default)	Refer to the Programming Manual for default values.	✓		
20-02-08	<b>System Options for Multiline Telephones – LCD Display Holding Time</b> Determine the time a user display shows Caller ID for a second incoming call.	0 ~ 64800 seconds	5		✓	
20-11-11	<b>Class of Service Options (Hold/Transfer Service) – Automatic On-Hook Transfer</b> Turn Off or On an extension user ability to use Automatic On-Hook Transfer.	0 = Off 1 = On	COS 1 ~ 15 = 0		✓	

Program Number	Program Name/Description	Input Data	Default	Level		
				1	2	3
20-11-14	<b>Class of Service Options (Hold/Transfer Service) – Trunk-to-Trunk Transfer Restriction</b> Turn Off or On the Trunk-to-Trunk Transfer Restriction. If enabled, Trunk-to-Trunk Transfer is impossible.	0 = Off 1 = On	COS 1 ~ 15 = 0		✓	
20-11-21	<b>Class of Service Options (Hold/Transfer Service) – Restriction for Tandem Trunking on Hang Up</b> Allow/Deny an extension user ability to set up a tandem/ conference call automatically when they hang up.	0 = Allow 1 = Deny	COS 1 ~ 15 = 0		✓	
20-25-15	<b>ISDN Options – Call Reference Selection for PRI 2 B-Channel Transfer</b> Turn ON (1) or OFF (0) the ability for an incoming call to be transferred (Trunk-to-Trunk) to an outgoing call when 2 B-Channel Transfer is used.	0 = Negative Integer 1 = No Edit	0	✓		
24-02-09	<b>System Options for Transfer – Two B-Channel Transfer Retry Timer</b> Enable/Disable disconnect Supervision for the system trunks.	0 ~ 64800 seconds	10		✓	

## Operation

### To Perform an ISDN 2 B-Channel Transfer:

1. Receive or make an ISDN trunk call.
2. Go off-hook using the handset, or press **Speaker** (the Call Appearance key or direct trunk appearance lights). Talk with the outside party.
3. Press the **Transfer** key.
4. Dial **9** to access second ISDN trunk.
5. Dial the **outside number** and wait for the outside party to answer.
6. Hang up.
7. LCD returns to idle after the LCD Display Hold timeout (Program 20-02-08).

## Programming Flowchart for ISDN-PRI – Answering Calls

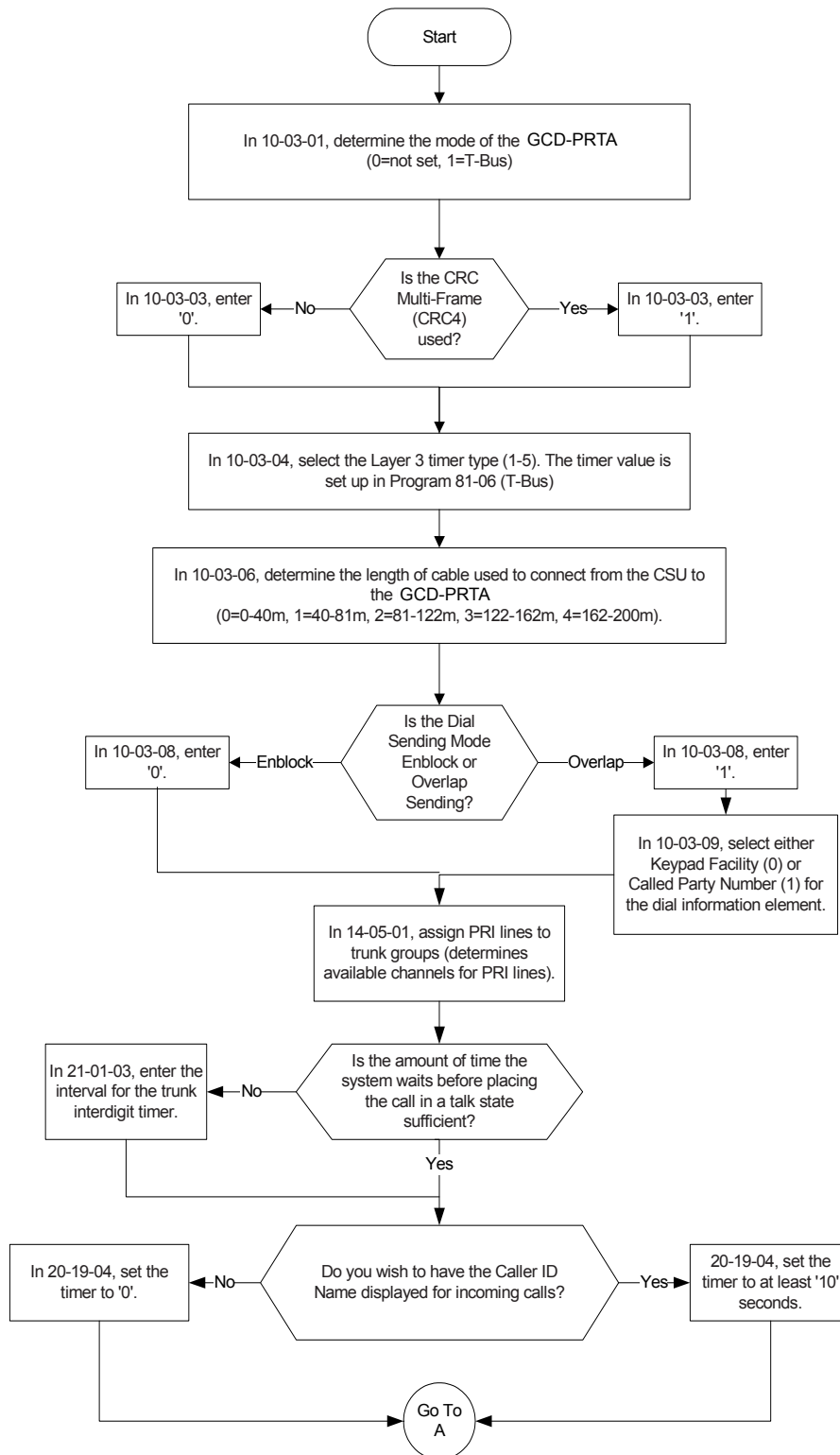



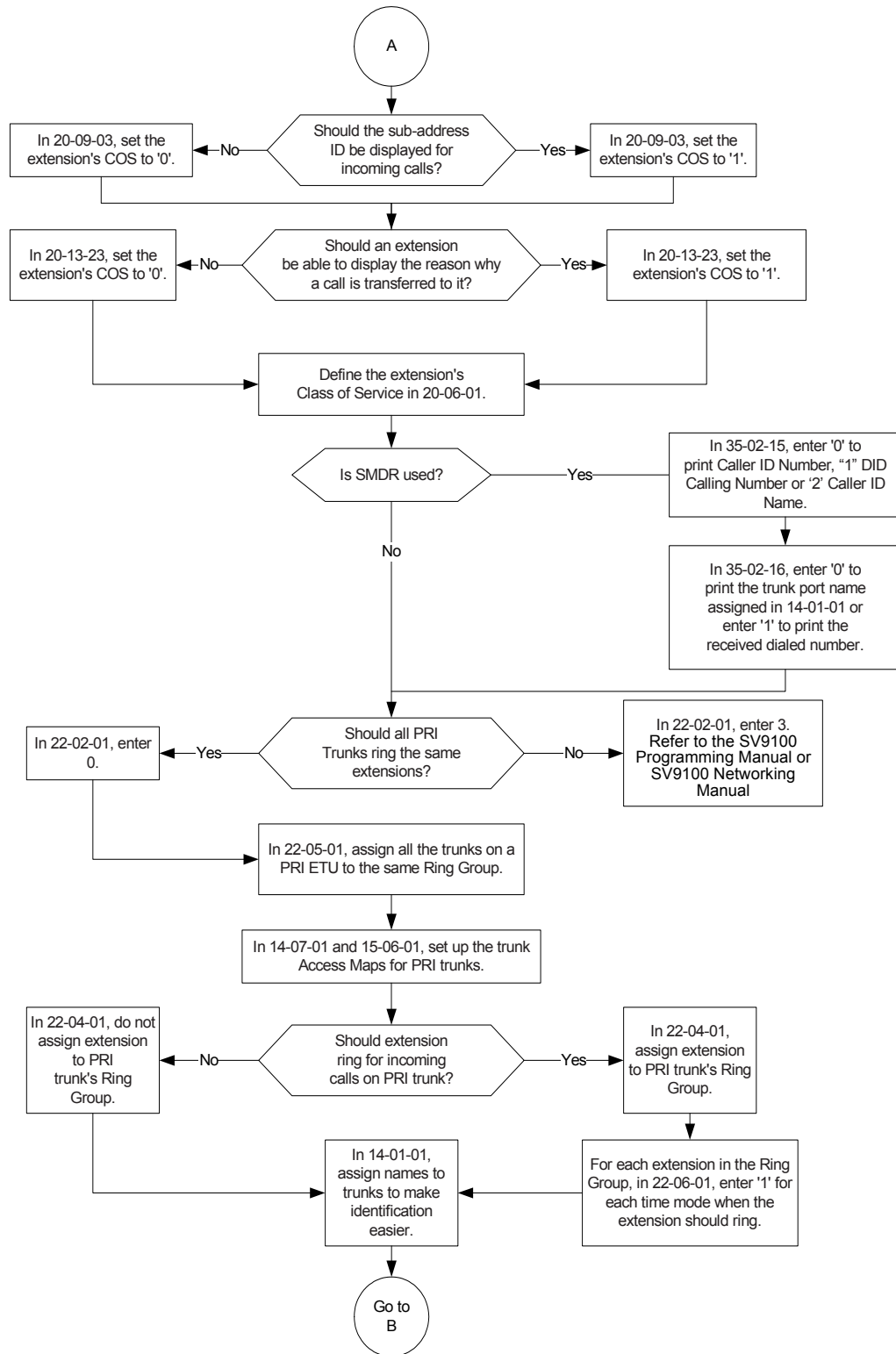

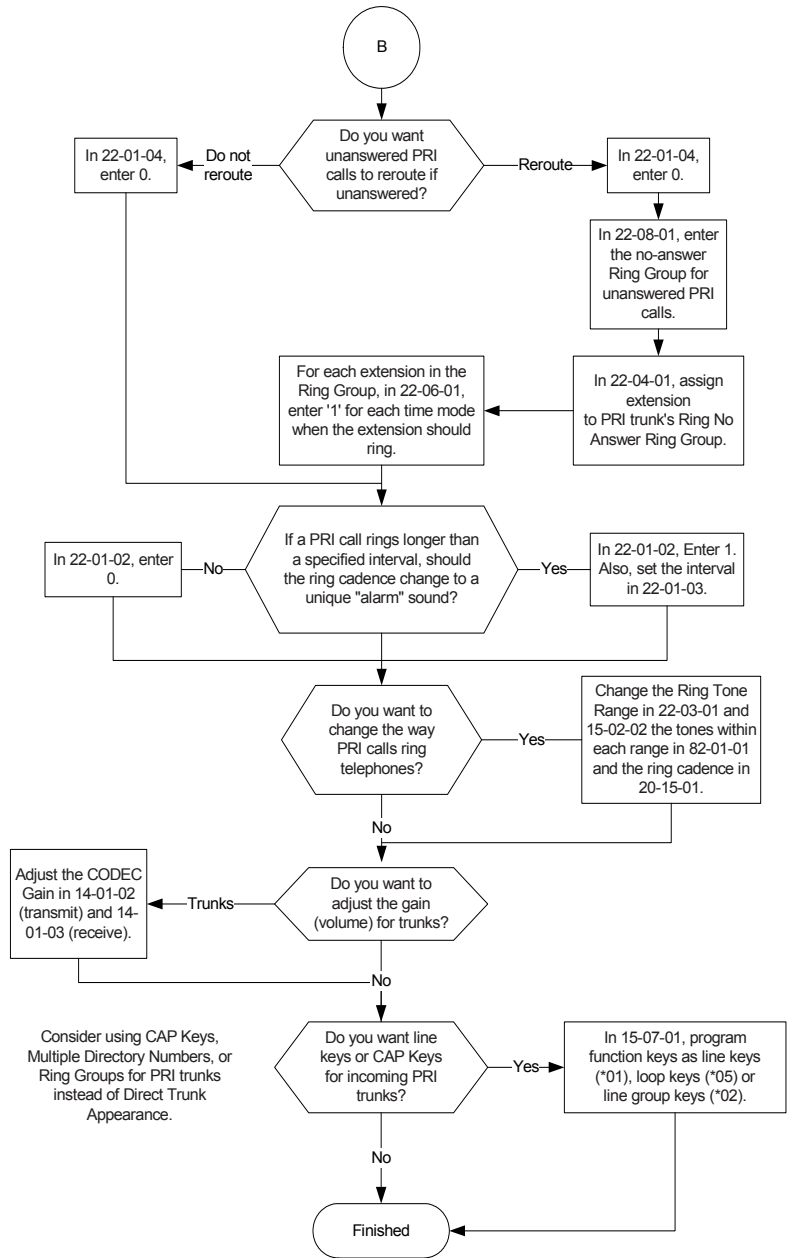

Consider using CAP Keys, Multiple Directory Numbers, or Ring Groups for PRI trunks instead of Direct Trunk Appearance.

## Programming Flowchart of ISDN-PRI – Placing Calls

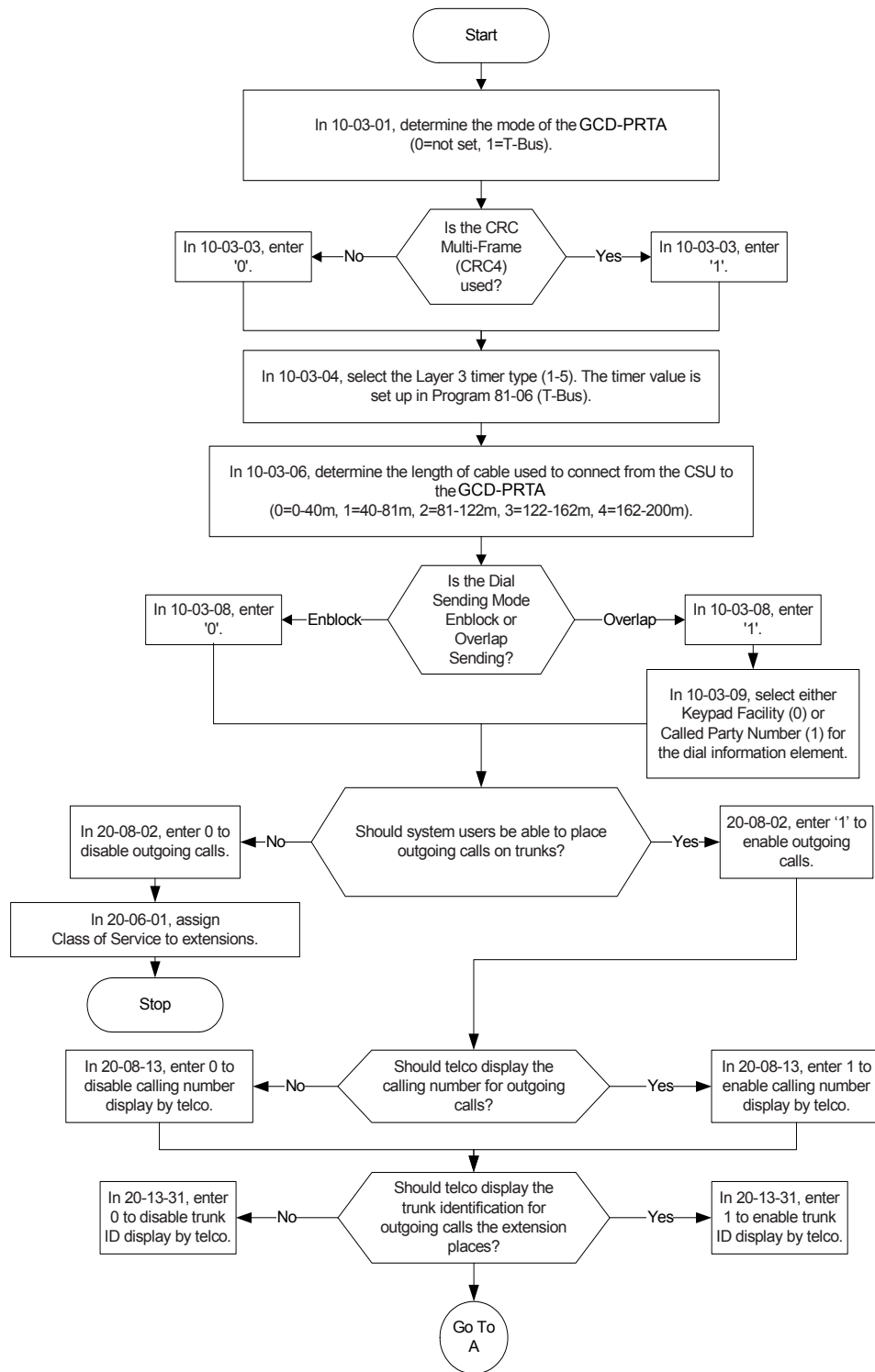

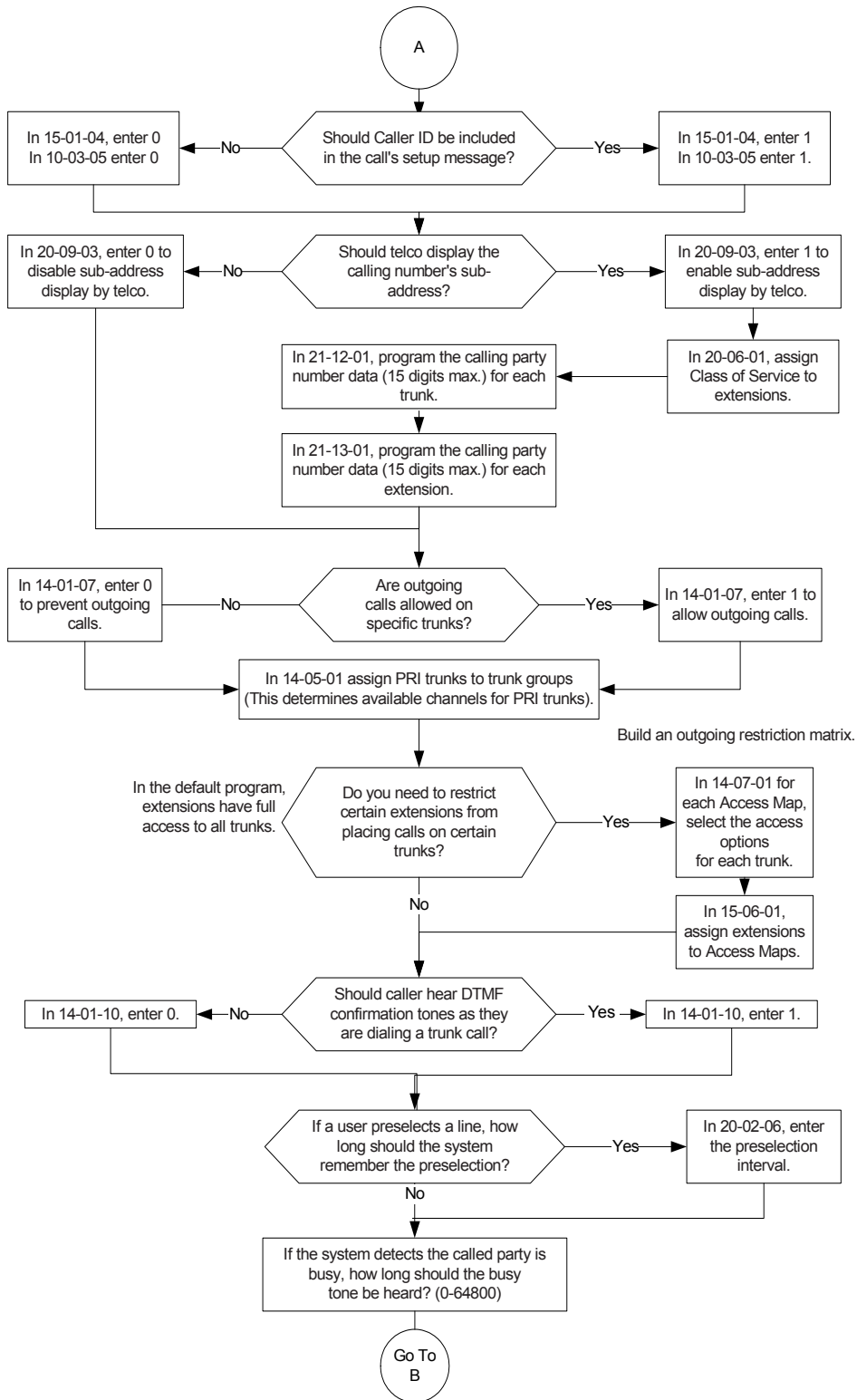

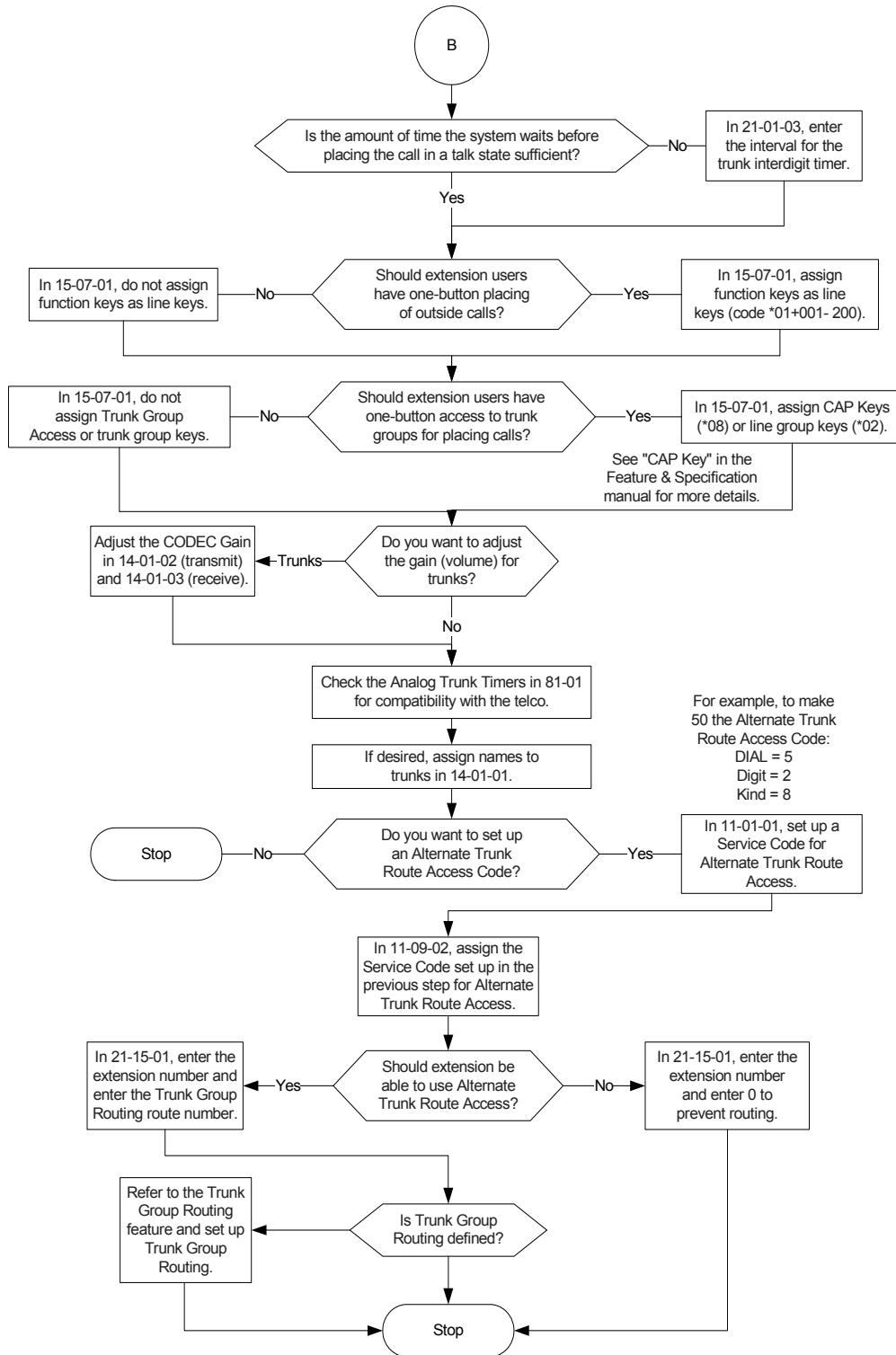

## IVR – Appointment Reminder Server

### Description

The IVR – Appointment Reminder Server solution is designed to provide a knowledge-based, intelligent distributed application to optimize the scheduling and reminder of appointments. The IVR – Appointment Reminder Server is an external software application that connects to the SV9100 through Standard SIP Ports. The IVR – Appointment Reminder Server can be configured for 8 – 16 ports using SV9100 licensing.

This IVR – Appointment Reminder Server enables the phone system to automatically call customers and remind them of their upcoming appointment. The Appointment Reminder automatically dials based on a configurable schedule and upon detection of a “live voice” or answering device, delivers one of your pre-recorded messages. The customer is then provided options to confirm the appointment or, if they desire, to be able to talk to a customer service representative.

The Appointment Reminder was designed for the following verticals:

- Dentist office
- Doctor’s office
- Optometrist’s office and other medical offices where scheduling is in common use.
- Any other office where appointments are made and need to be reminded.

The contact numbers for the customers are loaded in the form of a CSV file using a web page on the Appointment Reminder system. This file can offer up to three different alternate phone numbers to dial including Home, Mobile, and Business numbers in any order you prefer. This file contains the date/time of the appointment and the name of the customer to be called. Contact Numbers can also be manually added one by one through the Appointment Reminder application to be used in times when a small amount of numbers is to be called.

### Appointment Reminder Call Flow

- Out Bound Call - New Call

If the call is answered:

- Play Main Greeting
- Hello this is an appointment reminder from (name of customer). (Text to Speech name) your appointment is scheduled for (Time and Date). To confirm this appointment press 1, to replay this message press 2, to re-schedule this appointment or speak to someone in the office press 3.
- If customer presses “1”, annotate the database with the result saying that the customer has confirmed the appointment.
- If the customer presses “2” the message will be replayed
- If the customer presses “3” then the call will be transferred to a configurable destination in the phone system.

- If the customer presses anything other than 1, 2, or 3 he/she will be prompted to retry three times.
- If the customer continues to press wrong digit, after three times, the database is annotated with 'invalid selection' as the result, and the call is completed.

If the call is unanswered:

- If a new call goes unanswered (after one minute) the call will be marked as NO ANSWER in the database and the call will end.
- This call can be re-tried at an interval that is configurable.
- The call will be re-tried a configurable amount of times and then the outbound calls to this number will not be tried again.

### Conditions

- Peer to Peer (Program 15-05-50) must be disabled.
- The Appointment Reminder only supports the G.711 CODEC.
- All SIP stations programmed as Appointment Reminder ports must be in the same IP Duplication group (Program 15-05-18).
- The following Web Browsers are supported for configuring the IVR – Appointment Reminder Server; Internet Explorer 8, Internet Explorer 9, Firefox 3.6, Firefox 4 and Chrome™ 11.0.
- The IVR – Appointment Reminder Server can be configured for 8 – 16 ports.
- When a external user dials an invalid DTMF digit while listening to a recording, the initial message is stopped and the user is prompted to make the selection by dialing other digits.
  - The digits 1~9, 0, and \* can be programmed to show up in the callout log report, but the # character is not displayed in the report.
- If TOS settings are changed in the Appointment Reminder application, a reset of the IVR – Appointment Reminder Server is required.
- If the SV9100 is configured for Forced Account codes, the account code must be entered before the dialed number in the IVR – Appointment Reminder Server. For example: if the system account code is "123456" and the Appointment Reminder needs to call 9-214-555-1111 then the entry in the IVR – Appointment Reminder Server would be: 9\*123456\*2145551111.
- 1- or 2-digit extension numbers are not supported in a system that has IVR – Appointment Reminder Server installed.

### Default Settings

Disabled

## System Availability

### Terminals

All Terminals

### Required Component(s)

- GPZ-IPLE
- External IVR – Appointment Reminder Server
- 0411 – SV9100 Version Lic (R1)
- 0300 – SV9100 Resource Lic
- 5103 – SV9100 IP Resource Lic
- 5111 – SV9100 IP Phone Lic

### Related Features

None

## Guide to Feature Programming

The **Level 1**, **Level 2** and **Level 3** columns indicate the programs that are assigned when programming this feature in the order they are most commonly used. These levels are used with PCPro and WebPro wizards for feature programming.

- Level 1 – these are the most commonly assigned programs for this feature.
- Level 2 – these are the next most commonly assigned programs for this feature.
- Level 3 – these programs are not often assigned and require an expert level working knowledge of the system to be properly assigned.

Program Number	Program Name/Description	Input Data	Default	Level		
				1	2	3
10-12-03	<b>GCD-CP10 Network Setup – Default Gateway</b> Assign the default gateway IP address for the GCD-CP10.	0.0.0.0 ~ 126.255.255.254 128.0.0.1 ~ 191.255.255.254 192.0.0.1 ~ 223.255.255.254	0.0.0.0		✓	
10-12-09	<b>GCD-CP10 Network Setup – IP Address</b> Set IP address for GPZ-IPLE. It is recommended to set Program 10-12-01 to <b>0.0.0.0</b> . All connections to the system are made through the GPZ-IPLE.	0.0.0.0 ~ 126.255.255.254 128.0.0.1 ~ 191.255.255.254 192.0.0.1 ~ 223.255.255.254	172.16.0.10		✓	



Program Number	Program Name/Description	Input Data	Default	Level		
				1	2	3
10-12-10	<b>GCD-CP10 Network Setup – Subnet Mask</b> Set the subnet mask of the GPZ-IPL.	128.0.0.0   192.0.0.0   224.0.0.0  240.0.0.0   248.0.0.0   252.0.0.0  254.0.0.0   255.0.0.0  255.128.0.0   255.192.0.0  255.224.0.0   255.240.0.0  255.248.0.0   255.252.0.0  255.254.0.0   255.255.0.0  255.255.128.0   255.255.192.0  255.255.224.0   255.255.240.0  255.255.248.0   255.255.252.0  255.255.254.0   255.255.255.0  255.255.255.128  255.255.255.192  255.255.255.224  255.255.255.240  255.255.255.248  255.255.255.252  255.255.255.254  255.255.255.255	255.255.0.0		✓	
10-54-01	<b>License Configuration for Each Package – License Code</b> Assign VoIP Resource Licenses (5103) to GCD-CP10 slot (1). If applying more than 255 licenses to a slot, the licenses must be applied across multiple indexes. For example, assigning 256 VoIP resource licenses (5103) to the CPU slot could be assigned using different methods as long as the total for the CPU slot is 256. 1. Index 1 has 128 of feature code 5103 and index 2 also has 128 of feature code 5103 for a total of 256. 2. Index 1 has 255 of feature code 5103 and index 2 has 1 of feature code 5103 for a total of 256.	1 ~ 255 Resource Licenses	0	✓		
11-02-01	<b>Extension Numbering</b> Set the extension number for the Appointment Reminder ports. The extension numbers must be assigned to unused hardware ports to allow the Appointment Reminder SIP stations to register.	Maximum of eight digits.	1 101 2 102 3 103 ~ ~ 99 199 100 3101 ~ ~ 960 3961		✓	
11-07-01	<b>Department Group Pilot Numbers – Dial</b> Assign pilot numbers to each Department Group set up.	Maximum of eight digits.	No Setting	✓		

Program Number	Program Name/Description	Input Data	Default	Level		
				1	2	3
15-03-03	<p><b>Single Line Telephone Basic Data Setup – Terminal Type</b></p> <p>Enter 1 for this option to allow the SIP Station ports to receive DTMF tones after the initial call setup. For the Appointment Reminder, always enter 1 (e.g., receive DTMF tones).</p>	<p>0 = Normal 1 = Special</p>	0	✓		
15-05-18	<p><b>IP Telephone Terminal Basic Data Setup – IP Duplication Allowed Group</b></p> <p>For an adapter that has one IP address coming into it but multiple extensions off of it. Enable this option for all extensions in the group so the CPU knows that the one IP Address is assigned to multiple extensions.</p>	<p>0 = Disable 1 = Enable</p>	0	✓		
15-05-50	<p><b>IP Telephone Terminal Basic Data Setup – Peer to Peer Mode</b></p> <p>On a per station basis enable or disable Peer to Peer mode.</p> <p>➤ For each Appointment Reminder Port set to 0 = Disable.</p>	<p>0 = Disable 1 = Enable</p>	1	✓		
16-01-01	<p><b>Department Group Basic Data Setup – Department Name</b></p> <p>Use to assign the name for the Department Group to be used for the Appointment Reminder.</p>	Maximum of 12 characters.	No Setting		✓	
16-01-02	<p><b>Department Group Basic Data Setup – Department Calling Cycle</b></p> <p>Set the routing cycle for calls into a department (i.e., when a user dials the department pilot number). The system can ring the highest priority extension available (Priority Routing, 0) or cycle in circular order to a new idle extension for each new call (Circular Routing, 1).</p>	<p>0 = Normal Routing (Priority) 1 = Easy – UCD Routing (Circular)</p>	0		✓	
16-01-04	<p><b>Department Group Basic Data Setup – Hunting Mode</b></p> <p>This program sets what happens when an unanswered call to a Department Group pilot number reaches the last member of the group. If set to (0), once the last extension is called the hunting stops. If set to (1), once the last extension is called the hunting continues to search for an idle member to receive the call.</p> <p><b>1 (circular)</b> is recommended when using a Department Group for an Appointment Reminder.</p>	<p>0 = Last extension is called and hunting is stopped 1 = Circular</p>	0		✓	

Program Number	Program Name/Description	Input Data	Default	Level		
				1	2	3
16-01-10	<p><b>Department Group Basic Data Setup – Enhanced Hunt Type</b></p> <p>Set the type of hunting for each Extension (Department) Group.</p> <p><b>3 (Hunting When Busy or No Answer)</b> is recommended when using a Department Group for an Appointment Reminder.</p>	<p>0 = No queuing</p> <p>1 = Hunting When Busy</p> <p>2 = Hunting When Not Answered</p> <p>3 = Hunting When Busy or No Answer</p>	0		✓	
16-02-01	<p><b>Department Group Assignment for Extensions</b></p> <p>Use this program to assign all Appointment Reminder ports to the Department Group.</p>	<p>Department Groups 1 ~ 64</p> <p>Priority 1 ~ 9999</p>	<p>Default = 1 extensions in Department Group 1 with priority in port order:</p> <p>Port 1 priority = 1</p> <p>Port 256 priority = 256</p>	✓		
84-19-28	<p><b>SIP Extension CODEC Information Basic Setup – Audio Capability Priority</b></p> <p>Assign the CODEC that is to be used for any 3rd party SIP stations.</p> <p>When Appointment Reminder is installed, this program <b>must</b> be set to <b>0 (G.711)</b>.</p>	<p>0 = G.711_PT</p> <p>2 = G.729_PT</p> <p>3 = G.722</p> <p>4 = G.726</p> <p>5 = Not Used</p>	0		✓	
84-26-01	<p><b>IPL Basic Setup – IP Address</b></p> <p>Assign the IP address for the DSP on the GPZ-IPLE.</p>	xxx.xxx.xxx.xxx	172.16.0.20		✓	
84-34-01	<p><b>VoIPDB DTMF Setup – DTFMF Relay Mode</b></p> <p>Define the DTMF Relay Mode for 04 (SIP Extension).</p> <p>➡ <i>When Appointment Reminder is installed, this program must be set to 1 (RFC2833).</i></p>	<p>0 = Disable</p> <p>1 = RFC2833</p> <p>2 = H.245</p>	0	✓		

## Operation



— For operating procedures refer to the *UNIVERGE SV9100 IVR – Appointment Reminder Server Configuration Guide*.

## IVR – Broadcast Server

### Description

The IVR – Broadcast Server solution is designed to provide a knowledge based, intelligent distributed application which provides the most cost effective form of contacting your customers, employees, and prospects. The IVR – Broadcast Server is an external software application that connects to the SV9100 through Standard SIP Ports. The IVR – Broadcast Server can be configured for 8 – 16 ports using SV9100 licensing. Each IVR – Broadcast Server port requires the following license in the SV9100: SV9100 IP Client (STD/MLT)-Lic-1 (e.g. For 16 ports of Broadcast Server (16) SV9100 IP Client (STD/MLT)-Lic-1 must be purchased.)

This solution provides an effective way of communicating corporate voice messages, informational messages, past due notices, reminders, and verifications. The IVR – Broadcast Message solution is designed to call numbers from a managed list and plays a pre-recorded message to the call recipient or answering machine.

Broadcast was designed for the following verticals:

- Medical Offices
- Utility Companies
- Emergency Centers
- Any other office where messages are to be Broadcast to users.

The contact numbers for the customers are loaded in the form of a CSV file using a web page on the Broadcast system. This file can offer up to three different alternate phone numbers to dial including Home, Mobile, and Business numbers in any order you prefer. Contact Numbers can also be manually added one by one through the Broadcast application to be used in times when a small amount of numbers is to be called.

### **Broadcast Call Flow**

- Out Bound Call - New Call

If the call is answered:

- Play Main Greeting
- Hello this is a Broadcast message from (name of customer). Customers personal message played here. To replay this message press 1.
- If the customer presses **1** the message will repeat.
- If the customer presses anything other than the digit 1, they will receive a message stating "that was an invalid entry". After the incorrect digit is pressed three times the call is terminated.

If the call is unanswered:

- If a new call goes unanswered (after one minute) the call will be marked as NO ANSWER in the database and the call will end.

- This call can be re-tried at an interval that is configurable.
- The call will be re-tried a configurable amount of times and then the outbound calls to this number will not be tried again.

### Conditions

- Peer to Peer (Program 15-05-50) must be disabled.
- IVR – Broadcast only supports the G.711 CODEC.
- All SIP stations programmed as IVR – Broadcast ports must be in the same IP Duplication group (Program 15-05-18).
- The following Web Browsers are supported for configuring the IVR – Broadcast Server; Internet Explorer 8, Internet Explorer 9, Firefox 3.6, Firefox 4 and Chrome 11.0.
- The IVR – Broadcast Server can be configured for 8 through 16 ports.
- When a external user dials an invalid DTMF digit while listening to a recording, the initial message is stopped and the user is prompted to make the selection by dialing other digits.
  - ◇ *The digits 1~9, 0, and \* can be programmed to show up in the callout log report, but the # character is not displayed in the report.*
- If TOS settings are changed in the IVR – Broadcast application, a reset of the IVR – Broadcast Server is required.
- 1 or 2 digit extension numbers are not supported in a system that has a IVR – Broadcast Server installed.
- If the SV9100 is configured for Forced Account codes, the account code must be entered before the dialed number in the IVR – Broadcast Server. For example, if the system account code is "123456" and the IVR – Broadcast Server needs to call 9-214-555-1111 then the entry in the IVR – Broadcast Server would be: 9\*123456\*2145551111.

### Default Settings

Disabled

## System Availability

### Terminals

All Terminals

### Required Component(s)

- GCD-CP10
- GPZ-IPLE
- External IVR – Broadcast Server
- 0411 – SV9100 Version Lic (R1)
- 0300 – SV9100 Resource Lic
- 5103 – SV9100 IP Resource Lic
- 5111 – SV9100 IP Phone Lic

### Related Features

None

### Guide to Feature Programming

The **Level 1**, **Level 2** and **Level 3** columns indicate the programs that are assigned when programming this feature in the order they are most commonly used. These levels are used with PCPro and WebPro wizards for feature programming.

- Level 1 – these are the most commonly assigned programs for this feature.
- Level 2 – these are the next most commonly assigned programs for this feature.
- Level 3 – these programs are not often assigned and require an expert level working knowledge of the system to be properly assigned.

Program Number	Program Name/Description	Input Data	Default	Level		
				1	2	3
10-12-03	<b>GCD-CP10 Network Setup – Default Gateway</b> Assign the default gateway IP address for the GCD-CP10.	0.0.0.0 ~ 126.255.255.254 128.0.0.1 ~ 191.255.255.254 192.0.0.1 ~ 223.255.255.254	0.0.0.0		✓	
10-12-09	<b>GCD-CP10 Network Setup – IP Address</b> Set IP address for GPZ-IPLE. It is recommended to set Program 10-12-01 to <b>0.0.0.0</b> . All connections to the system are made through the GPZ-IPLE.	0.0.0.0 ~ 126.255.255.254 128.0.0.1 ~ 191.255.255.254 192.0.0.1 ~ 223.255.255.254	172.16.0.10		✓	

Program Number	Program Name/Description	Input Data	Default	Level		
				1	2	3
10-12-10	<b>GCD-CP10 Network Setup – Subnet Mask</b> Set the subnet mask of the GPZ-IPLE.	128.0.0.0   192.0.0.0   224.0.0.0  240.0.0.0   248.0.0.0   252.0.0.0  254.0.0.0   255.0.0.0  255.128.0.0   255.192.0.0  255.224.0.0   255.240.0.0  255.248.0.0   255.252.0.0  255.254.0.0   255.255.0.0  255.255.128.0   255.255.192.0  255.255.224.0   255.255.240.0  255.255.248.0   255.255.252.0  255.255.254.0   255.255.255.0  255.255.255.128  255.255.255.192  255.255.255.224  255.255.255.240  255.255.255.248  255.255.255.252  255.255.255.254  255.255.255.255	255.255.0.0		✓	
10-54-01	<b>License Configuration for Each Package – License Code</b> Assign VoIP Resource Licenses (5103) to GCD-CP10 slot (1). If applying more than 255 licenses to a slot, the licenses must be applied across multiple indexes. For example, assigning 256 VoIP resource licenses (5103) to the CPU slot could be assigned using different methods as long as the total for the CPU slot is 256. 1. Index 1 has 128 of feature code 5103 and index 2 also has 128 of feature code 5103 for a total of 256. 2. Index 1 has 255 of feature code 5103 and index 2 has 1 of feature code 5103 for a total of 256.	1 ~ 255 Resource Licenses	0	✓		
11-02-01	<b>Extension Numbering</b> Set the extension number for the IVR – Broadcast ports. The extension numbers must be assigned to unused hardware ports to allow the IVR – Broadcast SIP stations to register.	Maximum of eight digits.	1 101 2 102 3 103 ~ ~ 99 199 100 3101 ~ ~ 960 3961		✓	
11-07-01	<b>Department Group Pilot Numbers – Dial</b> Assign pilot numbers to each Department Group set up.	Maximum of eight digits.	No Setting	✓		

Program Number	Program Name/Description	Input Data	Default	Level		
				1	2	3
15-03-03	<p><b>Single Line Telephone Basic Data Setup – Terminal Type</b></p> <p>Enter 1 for this option to allow the SIP Station ports to receive DTMF tones after the initial call setup. For Broadcast, always enter 1 (e.g., receive DTMF tones).</p>	<p>0 = Normal 1 = Special</p>	0	✓		
15-05-18	<p><b>IP Telephone Terminal Basic Data Setup – IP Duplication Allowed Group</b></p> <p>For an adapter that has one IP address coming into it but multiple extensions off of it. Enable this option for all extensions in the group so the CPU knows that the one IP Address is assigned to multiple extensions.</p> <p>All IVR – Broadcast ports must be assigned in a Duplication Group that have no other system ports assigned.</p>	<p>0 = Disable 1 = Enable</p>	0	✓		
15-05-50	<p><b>IP Telephone Terminal Basic Data Setup – Peer to Peer Mode</b></p> <p>On a per station basis enable or disable Peer to Peer mode.</p> <p>➡ All IVR – Broadcast must have this option disabled</p>	<p>0 = Disable 1 = Enable</p>	1	✓		
16-01-01	<p><b>Department Group Basic Data Setup – Department Name</b></p> <p>Use to assign the name for the Department Group to be used for the IVR – Broadcast.</p>	Maximum of 12 characters.	No Setting		✓	
16-01-02	<p><b>Department Group Basic Data Setup – Department Calling Cycle</b></p> <p>Set the routing cycle for calls into a department (i.e., when a user dials the department pilot number). The system can ring the highest priority extension available (Priority Routing, 0) or cycle in circular order to a new idle extension for each new call (Circular Routing, 1).</p>	<p>0 = Normal Routing (Priority) 1 = Easy – UCD Routing (Circular)</p>	0		✓	
16-01-04	<p><b>Department Group Basic Data Setup – Hunting Mode</b></p> <p>This program sets what happens when an unanswered call to a Department Group pilot number reaches the last member of the group. If set to (0), once the last extension is called the hunting stops.</p> <p>If set to (1), once the last extension is called the hunting continues to search for an idle member to receive the call.</p> <p><b>1 (circular)</b> is recommended when using a Department Group for a IVR – Broadcast.</p>	<p>0 = Last extension is called and hunting is stopped 1 = Circular</p>	0		✓	



Program Number	Program Name/Description	Input Data	Default	Level		
				1	2	3
16-01-10	<p><b>Department Group Basic Data Setup – Enhanced Hunt Type</b></p> <p>Set the type of hunting for each Extension (Department) Group.</p> <p><b>3 (Hunting When Busy or No Answer)</b> is recommended when using a Department Group for a IVR – Broadcast.</p>	<p>0 = No queuing</p> <p>1 = Hunting When Busy</p> <p>2 = Hunting When Not Answered</p> <p>3 = Hunting When Busy or No Answer</p>	0		✓	
16-02-01	<p><b>Department Group Assignment for Extensions</b></p> <p>Use this program to assign all Broadcast ports to the Department Group.</p>	<p>Department Groups 1 ~ 64</p> <p>Priority 1 ~ 9999</p>	<p>Default = 1 extensions in Department Group 1 with priority in port order:</p> <p>Port 1 priority = 1</p> <p>Port 256 priority = 256</p>	✓		
84-19-28	<p><b>SIP Extension CODEC Information Basic Setup – Audio Capability Priority</b></p> <p>Assign the CODEC that is to be used for any 3rd party SIP stations.</p> <p>When IVR – Broadcast is installed, this program <b>must</b> be set to <b>0 (G.711)</b>.</p>	<p>0 = G.711_PT</p> <p>2 = G.729_PT</p> <p>3 = G.722</p> <p>4 = G.726</p> <p>5 = Not Used</p>	0		✓	
84-26-01	<p><b>IPL Basic Setup – IP Address</b></p> <p>Assign the IP address for the DSP on the GPZ-IPLE.</p>	xxx.xxx.xxx.xxx	172.16.0.20		✓	
84-34-01	<p><b>VoIPDB DTMF Setup – DTFMF Relay Mode</b></p> <p>Define the DTMF Relay Mode for 04 (SIP Extension).</p> <p>➤ <i>When IVR – Broadcast is installed, this program must be set to 1 (RFC2833).</i></p>	<p>0 = Disable</p> <p>1 = RFC2833</p> <p>2 = H.245</p>	0	✓		

## Operation



— For operating procedures refer to the *UNIVERGE SV9100 IVR – Broadcast Server Configuration Guide*.



### Description

The CCIS Call Rerouting feature allows a system to use multiple call routing priorities when remote system trunks are all busy. The four priorities can be local or remote trunks. For example using ARS and F-Route table priorities the system can try up to four remote systems or up to three remote systems and a local trunk to route the outbound call to its destination. If an outbound route is unavailable for any reason the call will fall through to the next priority.

Figure 2-62 K-CCIS Call Rerouting Network

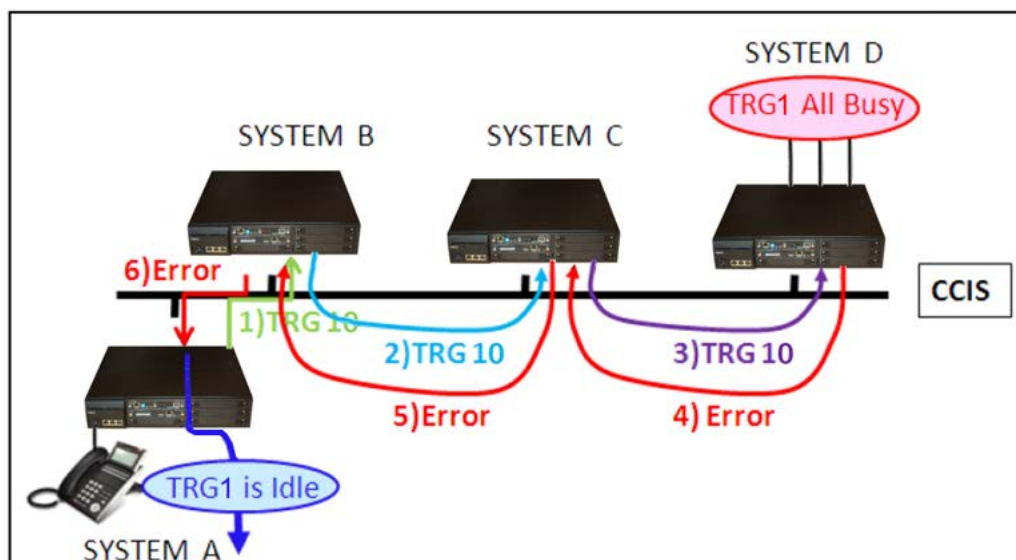

### Conditions

- The originating system must have a dial treatment of D019RE where 9 is the ARS trunk access code in the destination system for this feature to work.
- ARS must be enabled in all systems for this feature to work.
- The CCIS Call Rerouting feature is not supported on stations using 3rd party CTI.
- The CCIS Call Rerouting feature is not supported on a station which is controlled by 1st party CTI.
- The CCIS Call Rerouting feature will not work if Line Load Control has been triggered on the destination system.

- The CCIS Call Rerouting feature is only supported on CCISoIP with SV9100 systems.
- The CCIS Call Rerouting feature can only use the four routing options contained in one F-Route table.
- The CCIS Call Rerouting feature cannot fall through from one F-Route table to a second F-Route table.
- If none of the four F-Route table route priorities are available the outbound call will fail.

### Default Settings

None

## System Availability

### Terminals

All Terminals

### Required Component(s)

- GCD-CP10
- GPZ-IPLE
- 5012 – SV9100 Networking Lic
- 0411 – SV9100 Version Lic (R1)
- 0300 – SV9100 Resource Lic
- 5103 – SV9100 IP Resource Lic
- 5001 – SV9100 IP Trunk Lic

## Related Features

➔ **K-CCIS – IP**

## Guide to Feature Programming

The **Level 1**, **Level 2** and **Level 3** columns indicate the programs that are assigned when programming this feature in the order they are most commonly used. These levels are used with PCPro and WebPro wizards for feature programming.

- ❑ Level 1 – these are the most commonly assigned programs for this feature.
- ❑ Level 2 – these are the next most commonly assigned programs for this feature.
- ❑ Level 3 – these programs are not often assigned and require an expert level working knowledge of the system to be properly assigned.

◇ *The items highlighted in gray are read only and cannot be changed.*

Program Number	Program Name/Description	Input Data	Default	Level		
				1	2	3
10-12-01	<b>GCD-CP10 Network Setup – IP Address</b> Assign the IP Address for the CPU NIC card. When an GPZ-IPLE card is installed in the system, it is recommended to set this Program to <b>0.0.0.0</b> .	0.0.0.0 ~ 126.255.255.254 128.0.0.1 ~ 191.255.255.254 192.0.0.1 ~ 223.255.255.254	192.168.0.10		✓	
10-12-03	<b>GCD-CP10 Network Setup – Default Gateway</b> Assign the default gateway IP address for the GCD-CP10.	0.0.0.0 ~ 126.255.255.254 128.0.0.1 ~ 191.255.255.254 192.0.0.1 ~ 223.255.255.254	0.0.0.0	✓		
10-12-09	<b>GCD-CP10 Network Setup – IP Address</b> Set IP address for GPZ-IPLE. ➡ <i>The IP Address assigned in Program 10-12-01 cannot start with the same leading digits as the IP Address assigned here.</i>	0.0.0.0 ~ 126.255.255.254 128.0.0.1 ~ 191.255.255.254 192.0.0.1 ~ 223.255.255.254	172.16.0.10		✓	
10-19-01	<b>VoIP DSP Resource Selection</b> Select type of GPZ-IPLE DSP Resource. This program setting has no affect on the terminal/trunk port assignment or usage.	0 = Common use for both IP extensions and trunks 1 = IP Extension 2 = SIP Trunk 3 = CCIS/Networking 4 = Use for NetLink 5 = Blocked 6 = Common without Unicast Paging 7 = Multicast Paging 8 = Unicast Paging	Resource 1 = 1 Resource 2 ~ 256 = 0			✓
10-50-01	<b>License Information – License Name</b> Confirm license information that is stored in a system.		Refer to the Programming Manual for default values.		✓	

Program Number	Program Name/Description	Input Data	Default	Level		
				1	2	3
10-54-01	<p><b>License Configuration for Each Package – License Code</b></p> <p>Assign VoIP Resource Licenses (5103) to GCD-CP10 slot (1).</p> <p>If applying more than 255 licenses to a slot, the licenses must be applied across multiple indexes.</p> <p>For example, assigning 256 VoIP resource licenses (5103) to the CPU slot could be assigned using different methods as long as the total for the CPU slot is 256.</p> <p>1. Index 1 has 128 of feature code 5103 and index 2 also has 128 of feature code 5103 for a total of 256.</p> <p>2. Index 1 has 255 of feature code 5103 and index 2 has 1 of feature code 5103 for a total of 256.</p>	1 ~ 255 Resource Licenses	0	✓		
10-68-01	<p><b>IP Trunk Availability – Trunk Type</b></p> <p>Set trunk type to CCISoIP for interconnecting trunks.</p>	0 = None 1 = SIP 2 = H.323 3 = CCIS	0	✓		
10-68-02	<p><b>IP Trunk Availability – Start Port</b></p> <p>Set the trunk port number to start the assignment from.</p>	0 ~ 400	0	✓		
10-68-03	<p><b>IP Trunk Availability – Number of Ports</b></p> <p>Set the number of ports to assign from the starting point set in Program 10-68-02.</p>	0 ~ 400	0	✓		
11-01-01	<p><b>System Numbering – Service Code</b></p> <p>Customize the system internal (Intercom) numbering plan.</p> <p>➡ <i>The Call Reroute feature only supports closed numbering.</i></p>		Refer to the Programming Manual for default values.	✓		
11-02-01	<p><b>Extension Numbering</b></p> <p>Assign extension numbers to extension ports. The telephone programming identity follows the port number – not the extension number.</p>	Maximum of eight digits.	1 101 2 102 3 103 ~ ~ 99 199 100 3101 ~ ~ 960 3961	✓		
14-01-38	<p><b>Trunk Basic Setup – Outgoing CLI Selection</b></p> <p>Read only program used to confirm the trunk type.</p>	0 = None 1 = SIP 2 = H.323 3 = CCIS	No Setting			

Program Number	Program Name/Description	Input Data	Default	Level		
				1	2	3
14-05-01	<b>Trunk Group – Trunk Group Number</b> For Auto-Answer of Non-Ringing Lines, assign trunks to trunk groups. This is part of Trunk Group Routing programming.	Trunk Port 1 ~ 400 Group Number 0 ~ 100 Priority 1 ~ 400	Default = Trunks 1 ~ 400 assigned to trunk group 1 with priorities equal to the trunk number. Trunk 1 = Priority 1 Trunk 400 = Priority 400.	✓		
20-09-08	<b>Class of Service Options (Incoming Call Service) – Calling Party Information</b> Turn Off or On and extension ability to display calling party information on CCIS calls.	0 = Off 1 = On	COS 1 ~ 15 = 1		✓	
20-14-02	<b>Class of Service Options for DISA/E&amp;M – Trunk Group Routing/ARS Access</b> Enable/Disable a DISA or tie trunk caller ability to dial 9 for Trunk Group Routing or Automatic Route Selection (ARS).	0 = Off 1 = On	COS 1 ~ 15 = 1		✓	
22-02-01	<b>Incoming Call Trunk Setup</b> For each Night Service mode, enter service type for each trunk.	Trunks 1 ~ 200 0 = Normal 1 = VRS (second dial tone if no VRS installed) 2 = DISA 3 = DID 4 = DIL 5 = E&M Tie line 6 = Delayed VRS 7 = ANI/DNIS 8 = DID(DDI) Mode Switching	0	✓		
26-01-01	<b>Automatic Route Selection Service – ARS Service</b> Enable/Disable ARS.	0 = Disabled (ARS service is Off) 1 = Enabled (ARS service is On)	0	✓		
26-01-06	<b>Automatic Route Selection Service – Class of Service Match Access</b> With the ARS Class of Service Match Access feature, you can determine whether or not the system should allow a call based on the COS assigned to the Dial Analysis Table (Program 26-02). This change can be used to create a tenant-like application. It then uses the trunk group set in the Additional Entry in Program 26-02-03 to place the out-going call. When this feature is enabled, the calls are routed in sequential order, and forward – provided the Class of Service for the trunk groups match.	0 = Disable (Off) 1 = Enable (On)	0		✓	
26-01-07	<b>Automatic Route Selection Service – F-Route Access COS Reference</b> Define the system options for Automatic Route Selection (ARS).	0 = F-Route 1 = ARS	0		✓	

Program Number	Program Name/Description	Input Data	Default	Level		
				1	2	3
26-02-01	<p><b>Dial Analysis Table for ARS/LCR – Dial</b>                      Enter the digits (16 digits maximum: 1 ~ 9, 0 * #, @; 2000 separate entries) for the Dial Analysis Table which is analyzed by ARS/LCR. This table is checked after any programmed F-Route operations have completed. The system then refers to Program 26-02-02 and Program 26-02-03 to determine the routing for the call. To enter a wild card/don't care digit, press Line Key 1 to enter an @ symbol. It is important to remember that the system checks the table numbers in numerical order. This means that entries for specific numbers should be entered first (such as your local area codes), then enter the items containing wild card digits. If the system sees an entry of 2@@, any table entries which follow are ignored.</p> <p>For example, if 268, 269, and 270 are local exchanges, these would be the first three table entries which route according to the settings made in Program 26-02-02 and Program 26-02-03 for each of the table entries. If the next entry is 2@@, the system checks no further in this program and routes all other 2xx numbers according to the entries made in Program 26-02-02 and Program 26-02-03 for this table entry.</p>	Dial a maximum of 16 digits (0 ~ 9, * #, @)	No Setting	✓		
26-02-02	<p><b>Dial Analysis Table for ARS – ARS Service Type</b>                      For each Dial Analysis Table (1 ~ 2000), select 0 for no ARS, 1 for Service Type 1 – Route to Trunk Group Number to have the number route to a trunk group [Refer to Program 26-02-03] or 2 for Service Type 2 – F-Route Selected to have the dialed number controlled by the F-Route table. If Service Type 2 is selected and F-Route operation is on, the F-Route table used is determined by Program 44-04. If F-Route operation is off, the routing is determined by Program 44-05.</p>	0 = No Service (Call Restricted) 1 = Route to Trunk Group 2 = Select F-Route Access	0	✓		



Program Number	Program Name/Description	Input Data	Default	Level		
				1	2	3
26-02-03	<p><b>Dial Analysis Table for ARS – Additional Data/Service Number</b></p> <p>For each Dial Analysis Table (1 ~ 2000), if Service Type 1 was selected in Program 26-02-02, enter the trunk group number (0 ~ 100, 0 = No Route)</p>	<p>If Service Type 1 (in 26-02): Select Trunk Group Number 0 ~ 100, (Trunk Group Number 0 = No Route) 101 ~ 150 (Networking ID)</p> <p>If Service Type 2 (in 26-02): F-Route Time Schedule Not Used = 0 ~ 500 (F-Route Table Number). Refer to Programming Manual. F-Route Time Schedule Used = 0 ~ 500 (F-Route Selection Number) Refer to Programming Manual.</p>	0	✓		
26-02-04	<p><b>Dial Analysis Table for ARS – ARS Class of Service</b></p> <p>For each Dial Analysis Table (1 ~ 2000), set the Automatic Route Selection (ARS) (ARS) Class of Service (0 ~ 16).</p>	0 ~ 16	0		✓	

Program Number	Program Name/Description	Input Data	Default	Level		
				1	2	3
26-03-01	<p><b>ARS Dial Treatments – Treatment Code</b> Assign the Dial Treatments (1 ~ 15) for automatic ARS dialing translation. Assign Dial Treatments to Service Numbers (Trunk Groups) in Program 26-02. The ARS Dial Treatment options are:</p> <p><b>3</b> - Delete the NPA if dialed as part of the initial call. This requires at least eight digits in the ARS table (Program 26-02-01).</p> <p><b>2</b> - Delete the leading digit if dialed as part of the initial call. This requires at least eight digits in the ARS table (Program 26-02-01).</p> <p><b>1</b> - Add a leading 1 if not dialed as part of the initial call. This requires at least eight digits in the ARS table (Program 26-02-01).</p> <p><b>INPA</b> - Insert the NPA specified by NPA.</p> <p><b>DNN</b> - Outdial the NN number of digits or execute the code that follows. For example, D041234 out-dials 124. Valid entries are 0 ~ 9, #, *, Wnn (wait nn seconds) and P (pause). Each digits code counts as a digit. So for example, if a P was added for a pause, the entry would look like: D05P1234. This Dial Treatment can only be added from telephone programming.</p> <p><b>Wnn</b> - Wait nn seconds.</p> <p><b>P</b> - Pause in analog trunk.</p> <p><b>R</b> - Redial the initially dialed number, including any modifications.</p> <p><b>E</b> - End of Dial Treatment. All Dial Treatments must end with the E code.</p> <p><b>X</b> - When ARS is enabled, X must be entered in the Dial Treatment for the system to output the extension number of the call originator to the black box for the E911 feature.</p>	Maximum of 24 characters	No Setting		✓	
26-04-01	<p><b>ARS Class of Service</b> Set an extension ARS Class of Service (0 ~ 16). Automatic Route Selection (ARS) uses ARS Class of Service when determining how to route extension calls.</p>	Day/Night Mode: 1 ~ 8 Class = 0 ~ 16	0		✓	
34-02-01	<p><b>E&amp;M Tie Line Class of Service</b> Assign the Tie Line Class of Service (1 ~ 15). Use Program 20-14-01 to set the Tie Line Class of Service options. You cannot use Program 20-06 to assign Class of Service to Tie Lines.</p>	Day/Night Mode 1 ~ 8 Class: 1 ~ 15	1			✓
44-02-01	<p><b>Dial Analysis Table for ARS/F-Route Access – Dial</b> Set the dial digits to be analyzed by the system for ARS routing.</p>	Maximum of eight digits (Use line key 1 for a 'Don't Care' digit, @)	No Setting		✓	

Program Number	Program Name/Description	Input Data	Default	Level		
				1	2	3
44-02-02	<b>Dial Analysis Table for ARS/F-Route Access – Service Type</b> Select the Service Type.	0 = No Setting (None) 1 = Extension Call (Own) 2 = ARS/F-Route Table (F-Route) 3 = Dial Extension Analyze Table (Option)	0		✓	
44-02-03	<b>Dial Analysis Table for ARS/F-Route Access – Additional Data</b> Enter the additional data required for the service type selected in Program 44-02-02, either the number of digits to be deleted or the table number to be used.	1 = Delete Digit = 0 ~ 255 (255: Delete All Digits) 2 = 0 ~ 500 (0 = No Setting) 3 = Dial Extension Analyze Table Number = 0 ~ 4 (0 = No Setting)	0		✓	
44-05-01	<b>ARS/F-Route Table – Trunk Group Number</b> Select the trunk group number used for the outgoing ARS call (1 ~ 100).	0 = No Setting 1 ~ 100 = Trunk Group from Program 14-05 101 ~ 150 = Networking 255 = Extension Call	0	✓		
44-05-04	<b>ARS/F-Route Table – Beep Tone</b> For each ARS/F-Route table (1 ~ 500) assign a priority number (1 ~ 4). Turn Off or On a beep tone if a lower priority trunk group is used.	0 = Off (No Beep) 1 = On (Beep)s	0		✓	
44-05-07	<b>ARS/F-Route Table – ARS Class of Service</b> For each ARS/F-Route table (1 ~ 500) assign a priority number (1 ~ 4). Select the Class of Service used for ARS. An extension ARS COS is determined in Program 26-04-01.	0 ~ 16	0			✓
44-05-08	<b>ARS/F-Route Table – Dial Treatment</b> For each ARS/F-Route table (1 ~ 500) assign a priority number (1 ~ 4). Select the Dial Treatment to be used for the table. ➡ <i>The recommended treatment code is <b>D019RE</b> where 9 is the trunk access code in the destination system.</i> The Dial Treatments are determined in Program 26-03-01.	0 ~ 15	0	✓		
44-05-09	<b>ARS/F-Route Table – Maximum Digit</b> Input the maximum number of digits to send when using the F-Route.	0 ~ 24	0	✓		
44-05-10	<b>ARS/F-Route Table – CCIS over IP Destination Point Code</b> Input the Destination Point Code to send when using F-Route.	0 ~ 16367	0	✓		
50-01-01	<b>CCIS System Setting – CCIS Availability</b> No other CCIS settings function if this program is disabled.	0 = Disable 1 = Enable	0	✓		

Program Number	Program Name/Description	Input Data	Default	Level		
				1	2	3
50-02-03	<b>Connecting System Settings – Originating Point Code</b> For route ID 9, set the origination point code.	0 ~ 16367	No Setting	✓		
50-03-01	<b>CCIS Destination System Settings – Destination Point Code</b> Assign the destination transfer point code for Tandem KTS.	0 ~ 16367	0	✓		
50-03-03	<b>CCIS Destination System Settings – IP Address (IP only)</b> Assign remote system IP network information.	xxx.xxx.xxx.xxx (xxx = 0 ~ 255)	0.0.0.0	✓		
84-26-01	<b>IPL Basic Setup – IP Address</b> Assign the IP address for the DSP on the GPZ-IPLE.	xxx.xxx.xxx.xxx	172.16.0.20	✓		
84-26-02	<b>IPL Basic Setup – RTP Port Number</b> Assign the RTP port number to be used for each DSP on the GPZ-IPLE. ➡ Only even numbered ports are supported.	0 ~ 65534	10020			✓
84-26-03	<b>IPL Basic Setup – RTCP Port Number (RTP Port Number + 1)</b> Define the TCP port number for RTCP to use for each DSP.	0 ~ 65534	10021			✓

## Programming Example

The following example uses the first two priorities of System A to route 10 digit local calls out trunk group one of System B. If that fails, the call is routed out trunk group one of System A.

This example assumes the following:

- System A has local trunks 1-8 in trunk group 1.
- Both systems are already configured for the LAN on which they reside and have a network route to each other.
- Both systems are configured for K-CCISoIP.
- System A is assigned point code 1 and 1XX extensions.
- System B is assigned point code 2 and 2XX extensions.
- While dial analysis can be configured in all systems, for this example only System A has ARS dial analysis configured.

Program Number	Description	System A Setting	System B Setting
10-68-01	IP Trunk Mode CCIS	3	3

Program Number	Description	System A Setting	System B Setting
10-68-02	Starting CCIS Trunk Number	9	9
10-68-03	Number of CCIS Trunks to create. This creates trunks 9 ~ 16.	8	8
14-05-01	First setting data. Put CCISoIP trunks in trunk group 10.	10	10
14-05-01	Second setting data. Set priorities 1 ~ 8 for trunks 9 ~ 16.	1 ~ 8	1 ~ 8
26-01-01	Enable ARS services.	1	1
26-02-01	For table entry 1, enter 5 wildcard characters.	@@@@@	N/A
26-02-02	For table entry 1, set service type to F-Route (2).	2	N/A
26-02-03	For table entry 1, set additional data to F-Route table 2.	2	N/A
26-03-01	Set ARS Treatment 1 to sent the number including the trunk access code of 9 to System B.	D019RE	N/A
44-02-01	Closed numbering setup – Set to first digit of remote system extension number.	2	1
44-02-02	Closed numbering setup – Set to F-Route table (2).	2	2
44-02-03	Closed numbering setup – Set to use F-Route table 1 for intercom calls.	1	1
44-05-01	Closed numbering setup – Set table 1 first priority to use CCIS trunk group 10.	10	10
44-05-09	Closed numbering setup – Set table 1 first priority maximum digit length to 3.	3	3
44-05-10	Closed numbering setup – Set table 1 first priority to remote system point code.	2	1
44-05-01	ARS Routing – Set table 2 first priority to CCIS trunk group 10.	10	N/A
44-05-08	ARS Routing – Set table 2 first priority to dial treatment 1.	1	N/A
44-05-09	ARS Routing – Set table 2 first priority maximum dialing digit 11.	11	N/A
44-05-10	ARS Routing – Set table 2 first priority to System B point code (2).	2	N/A
44-05-01	ARS Routing – Set table 2 second priority to local trunk group 1.	1	N/A
44-05-09	ARS Routing – Set table 2 second priority maximum dialing digit 10.	10	N/A

## Operation



REFERENCE

*Refer to the UNIVERGE SV9100 Networking Manual for specific operations.*

## Description

The system uses the GPZ-IPLE daughter board to connect multiple systems together over a Data Communication IP Network (Intranet). Key-Common Channel Interoffice Signaling (KCCIS) is used to provide telephony services between the UNIVERGE SV9100 and another UNIVERGE SV9100 or a NEAX PBX system.

CCIS Networking via IP (Non Peer to Peer Connections Basis).

- IP trunk connections over CCIS Networking via IP provide telephony services between UNIVERGE SV9100 and UNIVERGE SV9100 and a NEAX IPS, IPX, SV7000, UNIVERGE SV8100, UNIVERGE SV8300 and UNIVERGE SV8500.
- The UNIVERGE SV9100 uses the NEC proprietary CCIS Peer to Peer protocol over IP to communicate between system to system.

The GPZ-IPLE is required for connections between IP terminals and IP trunks. Only one GPZ-IPLE daughter board can be accommodated per system with a maximum of 128 DSP resources per system.

The GPZ-IPLE daughter board is an optional interface package for converting the Real Time Transfer Protocol (RTP) packets on the IP network to PCM highway. IP telephones are required to be connected directly to the IP bus. When IP telephones are required to be connected to conventional PCM based digital circuit, the GPZ-IPLE converts IP packet signals. The GPZ-IPLE provides the digital signal processors (DSPs) for IP stations and trunks.

A DSP provides format conversion from circuit switched networks (TDM) to packet switched networks (IP). Each voice channel from the circuit switched network is compressed and packetized for transmission over the packet network. In the reverse direction, each packet is buffered for de-jittering, decompressed, and sent to the circuit switched network. Each DSP converts a single speech channel from IP to TDM and vice versa.

The following are examples of DSP allocation:

- Calling from IP telephone to a TDM telephone uses one DSP.
- Calling from an IP telephone to another IP telephone that is registered to the same CPU uses no DSPs.
- Calling from a TDM telephone to a TDM telephone uses no DSPs.
- Calling from a TDM telephone and out an IP trunk uses one DSP.
- Calling from a TDM telephone across IP K-CCIS to another TDM telephone uses one DSP.
- Calling from an IP telephone across IP K-CCIS to another IP telephone uses two DSP resources at each location.

As stated earlier in this document, using Encryption (RTPs) or Packet Loss Recovery (PLR) can reduce the number of available DSPs. Another thing that can reduce the amount of available DSPs is CODEC choice.

### MTU Size

In some network environments, the MTU size of the CCPU or IPL NIC may need to be changed. With **Version 2000 or lower** the MTU size was fixed to 1500 for both the CCPU and IPL NIC. With **Version 3000 or higher** the MTU size can now be changed for both the CCPU and IPL NIC.

If data to be sent is greater than defined in MTU, the data is transmitted in two or more packets as defined in the MTU.

### Systems Requirements

Only voice (RTP/RTCP) processing functions are mounted among VoIP functions on the GPZ-IPL. All call control functions are handled by the GCD-CP10.

Only one GPZ-IPL daughter board can be installed on the GCD-CP10.

The GPZ-IPL daughter board has Layer2 Switch ability, along with a Gigabit Ethernet LAN interface and RTP/RTCP packet is transmitted and received directly.

The number of ports supported by the IP K-CCIS (Peer to Peer) application depends on the GPZ-IPL installed on the GCD-CP10 and on the number of ports licensed in the GCD-CP10.

### Conditions

- MTU size defined in Program 10-12-18 is applied on the packets transmitted from the IP address defined in Program 10-12-01.
- MTU size defined in Program 10-12-19 is applied on the packets transmitted from the IPL IP address defined in Program 10-12-09.
- The MTU size value is applied after logging out from WebPro, PcPro or TelPro.
- MTU is not applied on RTP/RTCP packets generated from DSP of VoIPDB.
- A maximum of 400 IP Trunks are supported in the SV9100, but the maximum number of simultaneous talk paths depend on the size and available channels of the GPZ-IPL unit.
- When using ARS Class of Service Matching, CCIS calls always follow Class of Service 1.
- If single lines for fax machines are set to Special (Program 15-03-03), faxing across IP CCIS will always use G.711 CODEC.
- When using InMail in a CCIS or Netlink network, 8-digit extensions and mailboxes are not supported.
- When connecting a SV9100 to a NEAX PBX, Link reconnect needs to be turned off in the PBX to the SV9100.

- The CCISoIP Fax Enhancement feature supports G.711, G.726 and T.38 between two SV9100s.
- When using the CCISoIP Fax Enhancement feature between a SV9100 and a SV8300/SV8500, refer to the documentation for the SV8300/SV8500 system software level to determine if the desired Fax CODEC is supported and for information on setting up the feature on that system.
- When connecting to a SV8300 or SV8500 using K-CCIS the Call Back feature is not supported.
- The CCIS Call Back feature is only supported when using a closed numbering plan.
- The CCIS Call Back feature is not supported on K-CCIS – PVA.
- CCIS Call Back can only be set when the destination party is busy, and the calling party hears a busy tone.
- The calling party must hang up after setting CCIS Call Back.
- CCIS Call Back can only be set by pressing a programmed Feature key. Softkeys or dialing a service code is not supported.
- CCIS Call Back can only be set from a multiline terminal.
- CCIS Call Back target can only be a multiline terminal.
- The following telephones are not supported for either setting or receiving K-CCIS - Call Back:
  - Single Line Telephones
  - Standard SIP Telephones
  - IP-DECT Telephones
- For the CCIS Call Back to occur, CCIS trunks must be available in both systems.
- The setting party can only set Call Back to one destination telephone.
- One system can have a maximum of 50 Camp On/Call back requests set.
- Call Back requests are canceled by a system reset.
- When the destination extension does not become available within a specified time (Program 20-01-09), the CCIS Call Back is canceled. This timer is set on the destination system.
- If the setting extension does not answer the Call Back ring within a specified time (Program 20-01-07) the CCIS Call Back is canceled. This timer is set on the originating system.
- The called extension has the ability to receive Call Back settings from multiple extensions. If this occurs, the Call Back requests are returned in the order received.
- The K-CCIS – Call Back feature does not apply to trunk calls as it does not include trunk queuing features.



- Call Forward Busy No Answer must be disabled for a telephone to receive a CCIS Call Back request.
- The CCISoIP Fax Enhancement feature requires installation of the GPZ-IPLE IP daughter board.
- InMail is supported for centralized voice mail in a KTS to KTS CCIS network.
- In a CCIS network, the Memo Display Function only supports DID calls directed across CCIS to a remote system.
- Calls forwarded or transferred across CCIS do not support the Memo Display Function.
- With SV9100 software and IPLE daughter board installed, half duplex connections are not supported. For troubleshooting purposes, a managed switch capable of port mirroring is required to capture packet data from the SV9100 IPLE Ethernet port.
- Verified Account Codes for Toll Calls across a CCIS network are not restricted when a trunk access code is added to the number allowing ARS routing through another K-CCIS T1/IP networked site. This access code (typically a 9), precedes the dialed "1" used by the system to identify a long distance call. As a result, the call is no longer considered long distance and the account code is not required.
- Any calls across CCISoIP (station to station or stations transferring trunks) that use Quick Transfer to voice mail require an extra CAP key. The initial call across the CCISoIP link uses the first CAP key. When the digit "8" is pressed to perform the Quick Transfer, a second CAP key is accessed.
- When trunks are being shared for outbound calls between CCIS networks, all sites must utilize the same trunk access code.
- All IP trunks (SIP, CCIS, or H.323) must be contiguous. If any IP trunks are added to a system that already has IP trunks installed, and the next set of trunks is not in sequence, then all IP trunks are moved to a new set of sequential trunk numbers.
- In a PBX to UNIVERGE SV9100 network, Centralized Voice Mail is only supported using a closed numbering plan.

## CCIS Networking via IP (Peer to Peer Connections Basis)

### Description

IP-KCCIS has been improved to support Peer to Peer calls between IP Terminals residing in different offices, without using DSP resources. Refer to the SV9100 Networking manual for more information.

Table 2-77 K-CCIS Main and Remote System VoIP Resources Used

The number in each box indicates how many VoIP resources are used		Main System					Remote System				
		TDM Terminal	IP Terminal	CO Analog/Digital/SIP	CO Conf. IP Terminal	CO Conf. TDM Terminal	TDM Terminal	IP Terminal	CO Analog/Digital/SIP	CO Conf. IP Terminal	CO Conf. TDM Terminal
Main System	TDM Terminal	0	M: 1	0	M: 1	0	M: 1 R: 1	M: 1	0	M: 1	M: 1 R: 1
	IP Terminal	M: 1	0	M: 1	M: 2	M: 1	R: 1	0	R: 1	M: 2	M: 2 R: 1
Remote System	TDM Terminal	M: 1 R: 1	R: 1	M: 1 R: 1	R: 1	M: 1 R: 1	0	R: 1	0	R: 1	M: 1 R: 1
	IP Terminal	M: 1	0	M: 1	R: 2	M: 1 R: 2	R: 1	0	R: 1	R: 2	M: 1 R: 2

M = Main K-CCIS System  
R = Remote K-CCIS System

### Conditions

- The SV9100 to supports Peer to Peer in a CCISoIP network.
- DT700 terminals are supported for Peer to Peer connections via a P2P CCIS call.
- Standard SIP terminals are not supported for Peer to Peer connection.
- If Program 50-15-04 is set to 0 (Disable) in system A, Peer to Peer is disabled for system A and any remote systems when calling system A.
- When port translation is done through a NAT router, Peer to Peer is disabled.
- When RTP encryption is enabled, Peer to Peer is disabled.
- SV9100 K-CCIS-IP to another SV9100, for calls from an IP terminal to a TDM terminal/trunk via Peer to Peer, the IP Terminal's Codec must match the CCIS Codec and the packet size is auto negotiated based on the receiving sides packet size.
- SV9100 K-CCIS-IP to another SV9100 or to a NEAX PBX (SV8300, SV8500, etc.), for calls from an IP terminal to another IP terminal/trunk via Peer to Peer, the IP Terminal's Codec must match and the packet size is auto negotiated.

- SV9100 K-CCIS-IP to a NEAX PBX (SV8300, SV8500, etc.), for calls from an IP terminal to a TDM terminal via Peer to Peer, the IP Terminal's Codec and packet size (Program 84-24-XX) need to match the NEAX PBX CCIS Codec and packet size settings.
- With SV9100 software and IPLE daughter board installed, half duplex connections are not supported. For troubleshooting purposes, a managed switch capable of port mirroring is required to capture packet data from the SV9100 IPLE Ethernet port.

## Default Settings

Enabled

## System Availability

### Terminals

None

### Required Component(s)

- GCD-CP10 with GPZ-IPLE Daughter Board
- 0411 – SV9100 Version Lic (R1)
- 0300 – SV9100 Resource Lic
- 5103 – SV9100 IP Resource Lic
- 5012 – SV9100 Networking Lic

## Related Features

↳ [K-CCIS – IP with PVA](#)

## Guide to Feature Programming

The **Level 1**, **Level 2** and **Level 3** columns indicate the programs that are assigned when programming this feature in the order they are most commonly used. These levels are used with PCPro and WebPro wizards for feature programming.

- Level 1 – these are the most commonly assigned programs for this feature.
- Level 2 – these are the next most commonly assigned programs for this feature.
- Level 3 – these programs are not often assigned and require an expert level working knowledge of the system to be properly assigned.



*Refer to the UNIVERGE SV9100 Networking Manual for programming details.*

REFERENCE

Program Number	Program Name/Description	Input Data	Default	Level		
				1	2	3
10-12-18	<b>GCD-CP10 Network Setup – CCPU MTU</b> Define the MTU size for the packets sent from IP address defined in Program 10-12-01.	1000 ~ 1500	1450		✓	
10-12-19	<b>GCD-CP10 Network Setup – IPL MTU</b> Define the MTU size for the packets sent from IP address defined in Program 10-12-09.	1000 ~ 1500	1450		✓	
15-05-50	<b>IP Telephone Terminal Basic Data Setup – Peer to Peer Mode</b> On a per station basis enable or disable Peer to Peer mode.	0 = Disable 1 = Enable	1	✓		
50-15-04	<b>CCIS over IP Basic Information Setting – Connection Method for Terminal</b> Choose the connection method for the DT700.	0 = Peer to Peer disable 1 = Peer to Peer enable	1		✓	
84-34-01	<b>VoIPDB DTMF Setup – DTMF Relay Mode</b> When connecting to an SV8300/9300 or SV8500/9300 option 05 (CCIS over IP) must be set to 2 (H.245).	0 = Disable 1 = RFC2833 2 = H.245	0	✓		

**K-CCISoIP FAX:**

Program Number	Program Name/Description	Input Data	Default	Level		
				1	2	3
15-03-03	<b>Single Line Telephone Basic Data Setup – Terminal Type</b> Enter 1 for this option to allow a single line port to receive DTMF tones after the initial call setup. Enter 0 to have the port ignore DTMF tones after the initial call setup. For Voice Mail, always enter 1 (e.g., receive DTMF tones).	0 = Normal 1 = Special	0	✓		
84-33-12	<b>FAX Over IP Setup – FAX Codec</b> Setup FAX over IP Codec settings when using CCIS over IP.	1 = G.711 a-law 2 = G.711 u-law 3 = G726	2 = US 1 = other		✓	
84-33-13	<b>FAX Over IP Setup – Payload Size</b> Setup FAX over IP Codec settings when using CCIS over IP.	1 ~ 4 (10ms base)	2		✓	
84-33-14	<b>FAX Over IP Setup – Jitter Buffer Mode</b> Setup FAX over IP Codec settings when using CCIS over IP.	1 = Static 2 = Self Adjusting	1		✓	
84-33-15	<b>FAX Over IP Setup – Minimum Jitter Buffer</b> Setup FAX over IP Codec settings when using CCIS over IP.	0 ~ 300	80		✓	
84-33-16	<b>FAX Over IP Setup – Average Jitter Buffer</b> Setup FAX over IP Codec settings when using CCIS over IP.	0 ~ 300	120		✓	
84-33-17	<b>FAX Over IP Setup – Maximum Jitter Buffer</b> Setup FAX over IP Codec settings when using CCIS over IP.	0 ~ 300	160		✓	
84-33-18	<b>FAX Over IP Setup – RTP Payload Type</b> Setup FAX over IP Codec settings when using CCIS over IP.	0, 2, 8, 96 ~ 127	103		✓	
84-33-19	<b>FAX Over IP Setup – FAX over IP Type</b> Select FAX over IP type. Type 1: SV9100 original mode Type 2: PBX compatible mode If type 2 is selected, FAX over IP feature is executed using Program 84-33 settings.	1 = Type 1 2 = Type 2	1		✓	

**CCIS Call Back:**

Program Number	Program Name/Description	Input Data	Default	Level		
				1	2	3
15-07-01	<b>Programmable Function Keys</b> Assign a function for Camp-On (code 35). This key is also the Callback key.	Line Key 1 ~ 48 0 ~ 99 (Normal Function Code 751 by default) *00 ~ *99 (Appearance Function Code) (Service Code 752 by default)	Refer to the Programming Manual for default values.	✓		
20-01-07	<b>System Options – Callback Ring Duration Time</b> Set the time of the Callback ring. The timer is set on the originating system.	0 ~ 64800 seconds	15		✓	
20-01-09	<b>System Options – Callback/Trunk Queuing Cancel Time</b> The system cancels Callback and Trunk Queuing requests after this time. The timer is set on the destination system.	0 ~ 64800 seconds	64800		✓	
20-09-01	<b>Class of Service Options (Incoming Call Service) – Second Call for DID/DISA/DIL/E&amp;M Override</b> Turn Off or On the extension ability to receive a second call from a DID, DISA, DIL, or tie line caller. This should be set to Off (0) in the destination system.	0 = Off 1 = On	COS 1 ~ 15 = 1	✓		
20-09-07	<b>Class of Service Options (Incoming Call Service) – Call Queuing</b> Turn Off or On an extension ability to have calls queued if a call rings the extension when it is busy. This should be set to Off (0) in the destination system. ➡ Program 20-13-06 must be set to 0 (Off) for this feature to work.	0 = Off 1 = On	COS 1 ~ 15 = 1	✓		
20-13-05	<b>Class of Service Options (Supplementary Service) – Intercom Off-Hook Signaling</b> Turn Off or On an extension user ability to send Off-Hook Signals. This should be set to Off (0) in the destination system. ➡ This setting functions with Programs 20-09-07 and 20-13-06 disabled.	0 = Off 1 = On	COS 1 ~ 15 = 1	✓		

Program Number	Program Name/Description	Input Data	Default	Level		
				1	2	3
20-13-06	<p><b>Class of Service Options (Supplementary Service) – Automatic Off-Hook Signaling (Automatic Override)</b></p> <p>Allow a busy extension to Automatically (1) or Manually (0) receive off-hook Signals.</p> <p>Allow a busy extension to Automatically (1) or Manually (0) receive off-hook signals.</p> <p>➡ <i>This setting is to receive incoming call signaling information during call queuing.</i></p>	<p>0 = Off</p> <p>1 = On</p>	COS 1 ~ 15 = 1	✓		
20-13-35	<p><b>Class of Service Options (Supplementary Service) – Block Camp-On</b></p> <p>Turn Off or On extension user ability to block callers from dialing to camp-on.</p>	<p>0 = Off</p> <p>1 = On</p>	COS 1 ~ 15 = 0		✓	

## Operation



*Refer to the UNIVERGE SV9100 Networking Manual for detailed feature information.*

## K-CCIS – IP with PVA

### Description

The K-CCIS – IP with PVA feature provides the benefits and additional feature compatibility of Key-Common Channel Interoffice Signaling (K-CCIS) between multiple systems including NEAX PBX systems connected together over a Data Communication IP Network (Intranet). Voice Signals and common signaling from and to distant offices are converted into IP packets and transmitted through the Data IP Network. When using this feature, both Voice and Data Communication lines are integrated into one network and communication costs can be reduced.

This feature is available between UNIVERGE SV9100, UNIVERGE SV8100 and NEAX PBX systems.

The following features are provided:

- Automatic Recall
- Brokerage Hotline
- Call Forwarding – All Calls
- Call Forwarding – Busy/No Answer
- Call Park Retrieve
- Call Transfer – All Calls
- Calling Name Display
- Calling Number Display
- Calling Party Number (CPN) Presentation from Station
- Centralized Billing
- Centralized BLF (K-CCIS)\*
- Centralized Day/Night Mode Change
- Centralized E911
- Dial Access to Attendant
- Direct Inward Dialing
- Dual Hold
- Elapsed Time Display
- Flexible Numbering of Stations
- Hands-Free Answerback
- Hot Line
- Link Reconnect
- Multiple Call Forwarding – All Calls



- Multiple Call Forwarding – Busy/No Answer
- Paging Access
- Quick Transfer to Voice Mail
- Station-to-Station Calling
- Uniform Numbering Plan
- Voice Call
- Voice Mail Integration

\* Not supported with NEAX PBX.

### Conditions

- The K-CCIS – IP with PVA web interface supports Windows Internet Explorer 8 run on any Windows 7 operating system.
- The GCD-PVAA blade requires the K-CCIS – IP with PVA with PVA Compact Flash card.
- The K-CCIS – IP with PVA application can be licensed in increments of four or a single 24 ports.
- Each GCD-PVAA blade reduces the maximum capacity of trunks in the system.
- One GCD-PVAA is required to support up to 24 channels of K-CCIS – IP with PVA.
- Up to eight GCD-PVAA blades can be installed in the UNIVERGE SV9100.
- Port assignment of the GCD-PVAA package depends on the K-CCIS – IP with PVA license. You must input the license code **6200** in Program10-54 for each slot the PVA-CCIS package is installed.
- When multiple GCD-PVAA blades are installed in the same UNIVERGE SV9100, it is necessary to input Program 10-54 for each slot the K-CCIS – IP with PVA is installed. The total K-CCIS with PVA call count is limited by the license quantity installed in the system.

The following tables illustrate examples of K-CCIS – IP with PVA licensing and slot assignments:

*Table 2-78 GCD-PVAA Blade Installed in Slot 6*

Example #1	
License Quality: 8	Can make or receive a total of eight calls.
Program 10-54 = 8	Can assign eight ports and GCD-PVAA blade starts.
Example #2	
License Quality: 8	Cannot assign ports and GCD-PVAA blade does not start.
Program 10-54 = 0	

Table 2-78 GCD-PVAA Blade Installed in Slot 6

Example #1	
Example #3	
License Quality: 0	Cannot make or receive calls.
Program 10-54 = 8	Can assign eight ports and GCD-PVAA blade starts
Example #4	
License Quality: 8	Can make or receive a total of eight calls.
Program 10-54 = 24	Can assign 24 ports and GCD-PVAA blade starts

Table 2-79 GCD-PVAA Blade Installed in Slot 4 and Slot 6

Example #1	
License Quality: 16	Can Make or receive a total of 16 calls.
Program 10-54 (slot 4) = 8	Can assign eight ports and GCD-PVAA blade starts.
Program 10-54 (slot 6) = 8	Can assign eight ports and GCD-PVAA blade starts.
Example #2	
License Quality: 16	Can Make or receive a total of 16 calls.
Program 10-54 (Slot 4) = 16	Can assign 16 ports and GCD-PVAA blade starts.
Program 10-54 (Slot 6) = 16	Can assign 16 ports and GCD-PVAA blade starts.

- The K-CCIS – IP with PVA shares the CO/PBX/Tie/DID trunks available for the system.
- The GCD-PVAA blade supports only those codecs that are approved to provide toll-quality speech path. The following voice compression methods are supported for the K-CCIS – IP with PVA application:
  - ❑ G.711  $\mu$ -Law – Highest Bandwidth
  - ❑ G.729 – Mid-Range Bandwidth
  - ❑ G.723 – Lowest Bandwidth

- Each voice call requires at a minimum the bandwidth listed in the following table:

*Table 2-80 Minimum Bandwidth Required*

CODEC	Transmit Data Rate	Receive Data Rate	Time Between Packets	Packetization Delay	Default Jitter Buffer Delay	Theoretical Maximum MOS
G.711 $\mu$ -Law	90 Kbps	90 Kbps	20ms	1.5ms	2 datagrams (40ms)	4.4
G.729	34 Kbps	34 Kbps	20ms	15.0ms	2 datagrams (40ms)	4.07
G.723	25 Kbps	25 Kbps	30ms	37.5ms	2 datagrams (60ms)	3.87

- ➔ *This includes the overheads of VoIP communication including signaling.*
- ➔ *In voice communications, particularly Internet telephony, the mean opinion score (MOS) provides a numerical measure of the quality of human speech at the destination end of the circuit. The scheme uses subjective tests (opinionated scores) that are mathematically averaged to obtain a quantitative indicator of the system performance. A score of 5.0 is the maximum for the Mean Opinion Score.*

- Data Calls (Modem Data) across the VoIP connection are only supported when the G.711  $\mu$ -Law Codec is used.
- The GCD-PVAA blade contains a regular TCP/RTP/IP stack that can handle real-time media. The blade, from the network administration perspective, is an endpoint on the IP network.
- The GCD-PVAA with K-CCIS – IP with PVA application loaded uses Common Channel Interoffice Signaling over IP networks. Currently this protocol does not allow for communications across networks where Network Address Translation (NAT) is performed.
- The audio quality of speech connections depends greatly on the available bandwidth between the GCD-PVAA blade in the data network. As the Internet is an uncontrolled data network compared to an Intranet, using this application in an Intranet WAN environment, with known (or controlled and assured) Quality of Service (QoS), is highly recommended.
- If any network where the GCD-PVAA blade is connected uses NAT for connecting the voice calls (including firewall), consulting your network provider/administrator and specifically requesting service for VoIP or real-time media support on your networks is highly recommended.
- A static IP Address is required for each GCD-PVAA with K-CCIS – IP with PVA.
- This feature allows Point-to-Multipoint connections for calls through the IP K-CCIS Network. If a call is transferred or forwarded to a different system in the network, the trunks in the transferring system are released and a new point-to-point connection is established.
  - ◇ *When a call terminates back to the originating system because of call forwarding or transfer, the intermediate trunks are not released until the call is completed by an answer at the called party or until the call is forwarded to a different system (similar to the linkreconnect function in TDM CCIS).*

- The GCD-CCTA blade is not required to support this feature. It can be installed and used in a system using traditional K-CCIS with point-to-point T1 lines allowing both K-CCIS – IP with PVA and traditional K-CCIS to be used with the same system.
- The LAN connection is provided by a 10/100/1000 Base T, Auto-sensing, full duplex Ethernet.
- When assigning a Closed Numbering Plan and DID conversion across K-CCIS – IP with PVA is required, the UNIVERGE SV9100 uses the ARS/F-Route Tables.
- The UNIVERGE SV9100 uses the F-Route Tables to assign an Open Numbering Plan.
- When all K-CCIS – IP with PVA voice channels are busy, the UNIVERGE SV9100 originator of a K-CCIS – IP with PVA call hears a busy tone from the system.
- Outgoing CO calls in a K-CCIS – IP with PVA network can be routed over the K-CCIS – IP with PVA link and use the distant system CO lines.
- Distant system extension numbers in the K-CCIS – IP with PVA network can be assigned to One Touch keys and Speed Dial buffers.
- When a K-CCIS – IP with PVA trunk is on hold, the Specified Line Seizure access codes can be used to retrieve the call from its held state.
- FoIP (Fax over Internet Protocol) with T.38 protocol is only supported with SV9100 to SV9100.
- Each UNIVERGE SV9100 can support both K-CCIS – IP, K-CCIS – IP with PVA and SV9100 Net-link simultaneously.
- Each UNIVERGE SV9100 can support up to eight GCD-PVAA blades – (three) per chassis. Refer to the SV9100 System Hardware Manual for more information regarding maximum capacities.
- K-CCIS – IP with PVA **does not** require the use of the GPZ-IPLE (VoIPDB).
- One way delay must not exceed 100ms.
- Round Trip delay must not exceed 200ms.
- Packet loss must not exceed 1%.
- Data switches must be manageable.
- Routers must provide QOS.
- Adequate bandwidth for estimated VoIP traffic.
- Codec changes in Program 84-30-XX require a GCD-PVAA reset.
- The PVA-CCIS blade is supported in the primary system and/or secondary systems of a NetLink network.
- InMail is supported for centralized voice mail in a NetLink network. However, replication should be scheduled for non-peak hours of operation.
- InMail is supported for centralized voice mail in a CCIS network.

- Verified Account Codes for Toll Calls across a CCIS network are not restricted when a trunk access code is added to the number allowing ARS routing through another K-CCIS T1/IP networked site. This access code (typically a 9), precedes the dialed “1” used by the system to identify a long distance call. As a result, the call is no longer considered long distance and the account code is not required.
- Any calls across CCISoIP (station to station or stations transferring trunks) that use Quick Transfer to voice mail require an extra CAP key. The initial call across the CCISoIP link uses the first CAP key. When the digit “8” is pressed to perform the Quick Transfer, a second CAP key is accessed.
- When trunks are being shared for outbound calls between CCIS networks, all sites must utilize the same trunk access code.

### Restrictions

- The UNIVERGE SV9100 can send billing information to a billing center office (NEAX PBX System) but cannot receive the billing information as the billing center office.
- Not all data networks are suitable to support Voice over Internet Protocol (VoIP). A good VoIP solution requires a low-latency, low jitter and low packet loss network. Accordingly, a network must be evaluated for latency, packet loss, and jitter to qualify and determine if it can provide toll-quality speech paths.
- K-CCIS – IP with PVA application will support trunks configured in increments of four contiguous DSP resources.
- Blade Configuration – The K-CCIS – IP with PVA Application Package is identified as a PVA-XXCCIS blade type.
- When the K-CCIS – IP with PVA application is installed in the UNIVERGE SV9100, the system assigns the first available logical port numbers for CCISoIP trunks.
- When using K-CCIS – T1 or K-CCIS – IP with PVA in a Netlink system, the CCTA or PVA-CCIS blades are only supported in the primary system.
- If the UNIVERGE SV9100 system does not have registered GCD-PVAA K-CCIS – IP with PVA licenses, the Logical Trunk will not be assigned.
- The UNIVERGE SV9100 can support only 3~8-digit station numbers.
- Station Numbers are assigned by the 10s group for 4-digit station numbers, 100s group for 5-digit station numbers, 1000s group for 6-digit station numbers, 10000s group for 7-digit station numbers.
- When Voice Mail Message Waiting status must be sent across the K-CCIS to a remote system, F-Routes must be used.
- For a Closed Numbering Plan network using F-Routes, a maximum of 120 F-Route Tables are available allowing a maximum of 121 connected systems per K-CCIS network.
- When a Closed Numbering Plan Network is used, a user can call another station by dialing the distant extension number, but extensions in the network cannot have the same prefix.

- For an Open Numbering Plan network, a user can dial another station by dialing the office location number plus an extension number and the extension number can have the same prefix, but the office location cannot be the same.
- An UNIVERGE SV9100 K-CCIS network should never have more than five hops (tandem connections) because of the message delay through each tandem system.
- The maximum number of systems depends on the Numbering Plan used and the maximum number of hops (tandem connections).
- K-CCIS requires assigning a point code for each office. Point codes differentiate between an originating office and a destination office in the K-CCIS Network. Assigning point codes requires the following considerations:
  - The point code must be unique in the network.
  - The UNIVERGE SV9100 can have a maximum of 255 codes assigned to distant systems.
- Centralized voice mail is not supported when using an Open Plan number.
- In a PBX to UNIVERGE SV9100 network, Centralized Voice Mail is only supported using a closed numbering plan.
- Centralized E911 – K-CCIS is supported.
- When Centralized E911 – K-CCIS is not used, each UNIVERGE SV9100 system in a K-CCIS network must have at least one trunk for Emergency 911 calls.
- Using a NEAX-to-UNIVERGE SV9100 network, the PBX must supply centralized voice mail.
- Multiline terminals must have an available Call Appearance (CAP) key to originate or answer a K-CCIS – IP with PVA trunk call.
- Direct access of K-CCIS – IP with PVA voice or data channels using Line keys or Specified Line Seizure access codes is prohibited.
- The Recall key or Drop key does not function on K-CCIS – IP with PVA calls. When either key is pressed, operation is ignored, and the call continues.
- Trunk queuing is prohibited on a K-CCIS – IP with PVA trunk route.
- The ability to route an incoming DID call directly across a K-CCIS – IP with PVA link (Direct Inward Dialing – K-CCIS) is supported only when a Closed Numbering Plan using F-Routes is used.
- This feature is not supported by the CD-4ODTA Analog Line interface.
- Extension numbers cannot start with 0 or 9.
- Internal Calls, transferred calls, and K-CCIS – IP with PVA calls do not provide Caller ID to single line telephones.
- Caller ID Call Return feature is not supported with K-CCIS – IP with PVA calls.
- When using InMail in a CCIS or Netlink network, 8-digit extensions and mailboxes are not supported.

- The CCISoIP Fax Enhancement feature is not supported when using K-CCIS – IP with PVA.
- The CCIS Call Back feature is not supported when using K-CCIS – IP with PVA.

### Default Settings

None

## System Availability

### Terminals

All Terminals

### Required Component(s)

- GCD-PVAA w/K-CCIS-IP Compact Flash
- 6200 – PVA-CCIS Port Lic, 4 port license
- 6200 – PVA-CCIS Port Lic, 24 port license
- GCD-CP10
- 0411 – SV9100 Version Lic (R1)
- 0300 – SV9100 Resource Lic

## Related Features

➔ **K-CCIS – IP**

## Guide to Feature Programming



*Refer to the UNIVERGE SV9100 Networking Manual for programming details.*

## Operation

Normal call handling procedures apply.



*Refer to the UNIVERGE SV9100 Networking Manual for detailed feature information.*

## Description

Key-Common Channel Interoffice Signaling (K-CCIS) allows multiple systems to be connected to provide additional feature compatibility, above what normal Tie Lines provide. The system is configured with a 24 channel T1 Connection and GCD-CCTA for receiving or transmitting common signaling data from/to a distant office. The system can provide a variety of interoffice service features such as Calling Name display, Centralized Voice Mail Integration, or Link Reconnect.

The following features are provided:

- Call Forwarding – All Calls – K-CCIS
- Call Forwarding – Busy/No Answer – K-CCIS
- Call Park Retrieve – K-CCIS
- Call Transfer – All Calls – K-CCIS
- Calling Name Display – K-CCIS
- Calling Number Display – K-CCIS
- Calling Party Number (CPN) Presentation from Station – K-CCIS
- Centralized Billing – K-CCIS
- Centralized BLF (K-CCIS)
- Centralized Day/Night Mode Change – K-CCIS
- Centralized E911 (K-CCIS)
- Dial Access to Attendant – K-CCIS
- Direct Inward Dialing – K-CCIS
- Dual Hold – K-CCIS
- Elapsed Time Display – K-CCIS
- Flexible Numbering of Stations – K-CCIS
- Hands-Free Answerback – K-CCIS
- Hot Line – K-CCIS
- IP (K-CCIS)
- IP (K-CCIS) to NEAX (Point-to-Multipoint)
- Link Reconnect – K-CCIS
- Multiple Call Forwarding – All Calls – K-CCIS
- Multiple Call Forwarding – Busy/No Answer – K-CCIS
- Paging Access – K-CCIS



- Quick Transfer to Voice Mail – K-CCIS
- Station-to-Station Calling – K-CCIS
- Uniform Numbering Plan – K-CCIS
- Voice Call – K-CCIS
- Voice Mail Integration – K-CCIS \*

\* Not supported with InMail.

## Conditions

- Each UNIVERGE SV9100 system can have up to eight K-CCIS routes.
- Eight GCD-CCTAs can be used to support/connect a maximum of eight K-CCIS Links.
- The Basic Port Package can have up to 63 T1 trunks for K-CCIS voice path.
- The Expanded Port Package can have up to 199 T1 trunks for K-CCIS voice path.
- The K-CCIS feature shares the CO/PBX/Tie/DID trunks available for the system.
- When assigning a Closed Numbering Plan and DID conversion across K-CCIS is required, the UNIVERGE SV9100 uses the ARS/F-Route Tables.
- The UNIVERGE SV9100 uses the F-Route Tables to assign an Open Numbering Plan.
- When all K-CCIS voice channels are busy, the UNIVERGE SV9100 originator of a K-CCIS call hears a busy tone from the system.
- Outgoing CO calls in a K-CCIS network can be routed over the K-CCIS link and use the distant system CO lines.
- Distant system extension numbers in the K-CCIS network can be assigned to Feature Access or One Touch keys and Speed Dial buffers.
- When a K-CCIS trunk is on hold, the Specified Line Seizure access codes can be used to retrieve the call from its held state.
- The UNIVERGE SV9100 can support only 2~8-digit station numbers.
- Station Numbers are assigned by the 10s group for 4-digit station numbers, 100s group for 5-digit station numbers, 1,000s group for 6-digit station numbers, 10,000s group for 7-digit station numbers.
- When Voice Mail Message Waiting status must be sent across the K-CCIS to a remote system, F-Routes must be used.
- For a Closed Numbering Plan network using F-Routes, a maximum of 120 F-Route Tables are available allowing a maximum of 121 connected systems per K-CCIS network.
- When a Closed Numbering Plan Network is used, a user can call another station by dialing the distant extension number, but extensions in the network cannot have the same prefix.

- For an Open Numbering Plan network, a user can dial another station by dialing the office location number plus an extension number and the extension number can have the same prefix, but the office location cannot be the same.
- When an UNIVERGE SV9100 system is a tandem system (in the middle) between systems with higher K-CCIS feature support (including NEAX PBXs), only the K-CCIS features supported by the UNIVERGE SV9100 tandem system are passed through and supported.
- An UNIVERGE SV9100 K-CCIS network should never have more than five hops (tandem connections) because of the message delay through each tandem system.
- A Star topology network supports up to eight systems.
- A Tree topology network is supported. The maximum number of systems depends on the Numbering Plan used and the maximum number of hops (tandem connections).
- A Mesh topology network is not supported.
- K-CCIS requires assigning a point code for each office. Point codes differentiate between an originating office and a destination office in the K-CCIS Network. Assigning point codes requires the following considerations:
  - The point code must be unique in the network.
  - When a system has two or more CCH channels, the same originating point code must be assigned to all channels in the system.
  - The UNIVERGE SV9100 can have a maximum of 255 codes assigned to distant systems.
- Centralized voice mail is not supported when using an Open Plan number.
- In a PBX to UNIVERGE SV9100 network, Centralized Voice Mail is only supported using a closed numbering plan.
- Centralized E911 – K-CCIS is supported.
- When Centralized E911 – K-CCIS is not used, each UNIVERGE SV9100 system in a K-CCIS network must have at least one trunk for Emergency 911 calls.
- Using a NEAX-to-UNIVERGE SV9100 network, the PBX must supply centralized voice mail.
- Multiline terminals must have an available Call Appearance (CAP) key to originate or answer a K-CCIS trunk call.
- Direct access of K-CCIS voice or data channels using Line keys or Specified Line Seizure access codes is prohibited.
- The Recall key or Drop key does not function on K-CCIS calls. When either key is pressed, operation is ignored, and the call continues.
- Trunk queuing is prohibited on a K-CCIS trunk route.
- Routing an incoming DID call directly across a K-CCIS link (Direct Inward Dialing - K-CCIS) is supported only when a Closed Numbering Plan using F-Routes is used.
- This feature is not supported by the CD-4ODTA Analog Line interface.

- Up to eight GCD-CCTA blades can be assigned per system.
- Extension numbers cannot start with 0 or 9.
- Internal Calls, transferred calls, and K-CCIS calls do not provide Caller ID to single line telephones.
- Caller ID Call Return feature is not supported with K-CCIS calls.
- Call Park Searching is supported only in the local system.
- When the system searches the Dial Extension Analyze Table (Program 11-20-01), it uses prefix searching, giving the lower table number the higher priority. For example, the user programs 211 in table 1 and 2113 in table 2, then dials 2113, the system selects table 1.
- When using ARS Class of Service Matching, CCIS calls always follow Class of Service 1.
- InMail is supported for centralized voice mail in a KTS to KTS CCIS network.
- The T-1 CCTA blade is supported in the primary system and/or secondary systems of a NetLink network.
- When using InMail in a CCIS or Netlink network, 8-digit extensions and mailboxes are not supported.
- When connecting a SV9100 to a NEAX PBX, Link reconnect needs to be turned off in the PBX to the SV9100.
- Call Forward Busy No Answer must be disabled for a telephone to receive a CCIS Call Back request.
- When connecting to a SV8300 or SV8500 using KCCIS the Callback feature is not supported.
- This feature is only supported when using a closed numbering plan.
- CCIS Callback can only be set when the destination party is busy, and the calling party hears busy tone.
- The calling party must hang up after setting CCIS Call Back.
- CCIS Callback can only be set by pressing a programmed Feature key. Softkeys or dialing a service code is not supported.
- CCIS Callback can only be set from a multiline terminal.
- CCIS Call Back target can only be a multiline terminal.
- The following telephones are not supported for either setting or receiving CCIS Callback:
  - ❑ Single Line Telephones
  - ❑ Standard SIP Telephones
  - ❑ IP-DECT Telephones
  - ❑ H.323 Telephones
  - ❑ ISDN Telephones

- For the CCIS Call Back to occur there must be available CCIS trunks in both systems.
- The setting party can only set Callback to one destination telephone.
- One system can have a maximum of 50 Camp On/Call back requests set.
- Callback requests are canceled by a system reset.
- When the destination extension does not become available within a specified time (Program 20-01-09) the CCIS Callback will be canceled. This timer is set on the destination system.
- If the setting extension does not answer the Callback ring within a specified time (Program 20-01-07) the CCIS Callback will be canceled. This timer is set on the originating system.
- The called extension has ability to receive Callback settings from multiple extensions. If this occurs the Callback requests are returned in the order received.
- The CCIS Callback feature does not apply to trunk calls as it does not include trunk queuing features.
- Verified Account Codes for Toll Calls across a CCIS network are not restricted when a trunk access code is added to the number allowing ARS routing through another K-CCIS T1/IP networked site. This access code (typically a 9), precedes the dialed "1" used by the system to identify a long distance call. As a result, the call is no longer considered long distance and the account code is not required.
- Any calls across CCISoIP (station to station or stations transferring trunks) that use Quick Transfer to voice mail require an extra CAP key. The initial call across the CCISoIP link uses the first CAP key. When the digit "8" is pressed to perform the Quick Transfer, a second CAP key is accessed.
- When trunks are being shared for outbound calls between CCIS networks, all sites must utilize the same trunk access code.

## Default Settings

None

## System Availability

### Terminals

All Terminals

### Required Component(s)

- GCD-CCTA

- The following table shows the chassis system software compatibility with GCD-CCTA firmware and K-CCIS feature compatibility.

Chassis Software	CCTA
SV9100 V	X

X = Compatible  
 – = Not Compatible

## Related Features

- ➔ **T1 Trunking (with ANI/DNIS Compatibility)**
- ➔ **Universal Slots**

## Guide to Feature Programming



*Refer to the UNIVERGE SV9100 Networking Manual for specific programming details.*

## Operation



*Refer to the UNIVERGE SV9100 Networking Manual for specific operations.*





### Description

Last Number Redial allows an extension user to quickly redial the last number dialed. For example, a user may quickly recall a busy or unanswered number without manually dialing the digits.

Last Number Redial saves in system memory the last 24 digits a user dials. The number can be any combination of digits 0~9, # and \*. The system remembers the digits regardless of whether the call was answered, unanswered or busy. The system normally uses the same trunk group as for the initial call. However, the extension user can preselect a specific trunk if desired.

When Redial is pressed, the display indicates REDIAL [#] / ABB. The user can then press # to redial the number displayed, or enter an System Speed Dialing bin number to be dialed. Press the Redial key repeatedly to scroll through the last 10 numbers dialed.

### Cursor Key Operation

By pressing the Left Cursor Key the user can access the Redial and Incoming Call History menus. The flow chart below shows the menu access sequence. If the terminal is not allowed to have the Dial Preview feature, these menus cannot be accessed.

Figure 2-63 Left Cursor Key Operation Flow Chart

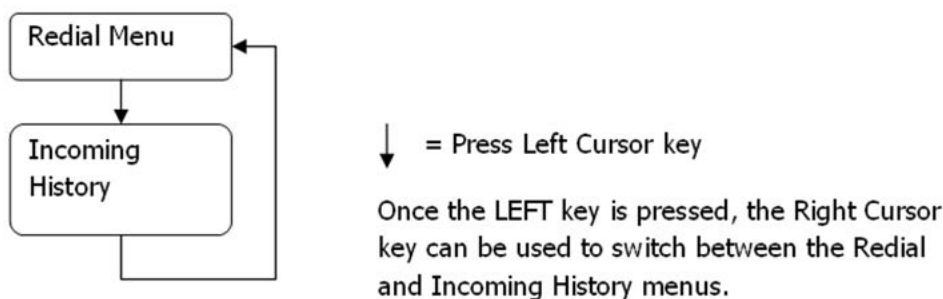

### Conditions

- Redial List requires the use of a display telephone. Non-display and single line telephones cannot use this feature.
- When using Automatic Route Selection, ARS selects the trunk for the call unless the user preselects.

## Default Settings

Enabled

## System Availability

### Terminals

All Terminals

### Required Component(s)

None

## Related Features

- ➔ [Automatic Route Selection \(ARS\)](#)
- ➔ [Repeat Redial](#)
- ➔ [Save Number Dialed](#)

## Guide to Feature Programming

The **Level 1**, **Level 2** and **Level 3** columns indicate the programs that are assigned when programming this feature in the order they are most commonly used. These levels are used with PCPro and WebPro wizards for feature programming.

- Level 1 – these are the most commonly assigned programs for this feature.
- Level 2 – these are the next most commonly assigned programs for this feature.
- Level 3 – these programs are not often assigned and require an expert level working knowledge of the system to be properly assigned.

Program Number	Program Name/Description	Input Data	Default	Level		
				1	2	3
11-12-12	<b>Service Code Setup (for Service Access) – Last Number Dial</b> Assign a service code (#5) to use Last Number Dial.	MLT, SLT 0 ~ 9, *, # Maximum of eight digits	#5		✓	
11-12-17	<b>Service Code Setup (for Service Access) – Clear Last Number Dialing Data</b> Assign a service code (776) to clear the Last Number Dial.	MLT, SLT 0 ~ 9, *, # Maximum of eight digits	776		✓	



Program Number	Program Name/Description	Input Data	Default	Level		
				1	2	3
15-02-13	<b>Multiline Telephone Basic Data Setup – Outgoing Caller List Mode</b> Select the type of numbers that are stored in the Redial List – Internal and External numbers (0) or External only (1).	0 = ICM/Trunk (Extension/Trunk Mode) 1 = Trunk Mode	1		✓	
20-08-05	<b>Class of Service Options (Outgoing Call Service) – Dial Number Preview (Preset Dial)</b> Turn Off or On an extension user ability to use Dial Number Preview. This program also turns Off or On the Last Number Redial function.	0 = Off 1 = On	COS 1 ~ 15 = 1		✓	

## Operation

### To redial your last call:

1. Without lifting the handset, press **Redial**.
  - ◇ *The last dialed number is displayed.*
2. To redial the last number, press **#**.
  - OR -

Search for the desired number from the Redial List by pressing **Redial** or VOLUME ▲ or VOLUME ▼ keys.

  - OR -

Press the **Left Cursor** key once and the VOLUME ▲ or VOLUME ▼ keys to find number.
3. Lift the handset or press **Speaker** to place the call.
  - ◇ *The system automatically selects a trunk from the same group as your original call and dials the last number dialed.*
  - OR -
  1. At the multiline terminal, press **Speaker** or lift the handset (optional).
    - OR -

At the single line telephone, lift the handset.
  2. Dial **#5**.
    - ◇ *The system automatically selects a trunk from the same group as your original call and dials the last number dialed.*

### To check the number saved for Last Number Redial:

1. Press **Redial** or the **Left Cursor** key once.  
The stored number displays for six seconds. The stored number dials out if you:
  - ◇ *Lift the handset.*
  - ◇ *Press an idle line key.*  
- or -
  - ◇ *Press **Speaker**.*
2. Press the **Exit** key.

### To erase the stored number:

1. At the multiline terminal, press **Speaker** or lift handset.  
**- OR -**  
At the single line telephone, lift the handset.
2. Dial **776**.

## Description

Licenses are used to activate certain features and applications for the UNIVERGE SV9100. The UNIVERGE SV9100 system provides the following licenses:

### System Licenses:

#### System Capacity

- IP Trunks – This licenses the number of SIP trunks that can be installed in the system.
- Port – This licenses the total number of ports that can be enabled in the system.
- VoIP Resource – This license enables VoIP resources on the GPZ-IPLE daughter board.
- IP Terminal – This licenses the number of SIP phones that can connect to the system.

#### System Feature License

- Enhancement Licenses – This licenses the system to run the software level installed on the GCD-CP10.
- NetLink – This licenses the number of remote system that can be connected to the main system.
- Hotel/Motel (PMS) – This licenses the system to run the Hotel/Motel feature.
- SMDR – This licenses the system to print SMDR reports.
- Remote Software Upgrade – This licenses the system to be upgraded remotely.
- This licenses the system to run the In feature.
- Encryption – This licenses the SV9100 system to encrypt VoIP calls.

#### Voice Mail (Embedded)

- VRS Channels – This licenses the number of VRS channels that can be used in the system.
- InMail Voice Mailbox Users – This licenses the number of InMail mailbox users that can be used in the system.
- InMail Email Client – This licenses the number of InMail users that can be allowed to receive email notification.

### Applications:

#### Voice Mail (InSkin US)

- UMS Fax Channel – This licenses the number FAX channels that can be used in the UMS.
- UMS Client (View Apps) – This licenses the number of simultaneous Client (View Apps) that can be connected to the UMS.

- UMS Multi-language – This licenses the number of languages that can be used simultaneously.
- UMS Hospitality/PMS – This licenses the UMS to run Hospitality/PMS.
- UMS Hospitality Language – This licenses the number of languages that can be used simultaneously with UMS Hospitality.
- UMS Amis/Plus Net – This licenses the UMS for Amis/Plus Net.
- UMS TTS Channel – This licenses the number of TTS channels that can be used in the UMS.
- UMS TTS Language – This licenses the number of languages that can be used simultaneously for TTS.
- UMS Lite Channel – This licenses the number of Voice Channels that can be used in UMS-Lite.
- UMS Lite 2 port Upgrade – Loading this license enables the upgrade option of the UMS.
- UMS Lite to Full Upgrade – This licenses upgrading UMS-Lite to UMS full.

**Desktop Application**

- Softphone – This licenses the number of Desktop Applications that can be used for Softphone.
- Desktop Shared Services – This licenses the number of Desktop Applications that can use the Shared Services features like presence, DSS/BLF view, central directory, phone message, and quick message.
- Desktop Client – This licenses the number of Desktop Applications that can be run.
- Softphone Enhancement – This licenses the number of Desktop Applications that can use White Board, Apps Share, and IM.
- Desktop Suite InMail Integration – This licenses the number of Desktop clients that can access the InMail function from Desktop Suite.

**MIS**

- MIS Basic – This licenses the SV9100 MIS.
- MIS Add Monitor – This licenses the SV9100 MIS for Monitor/Report.
- MIS Agent – This licenses the SV9100 MIS for Agent Client.

**PVA**

- PVA-IVR Channel – This licenses the number of IVR channels that can be used by the PVA.
- PVA-CCIS Channel – This licenses the number of CCIS channels that can be used by the PVA.
- PVA PMS – This licenses the PVA PMS feature for the system.

### Integration Methods

- 1st Party CTI Connection – This licenses the number of 1st Party CTI connections to the system.
- 3rd Party CTI Connection – This licenses the system to allow a 3rd Party CTI connection.
- SOAI Connection – This licenses the system to allow a SOAI connection.

### IP Recorder

- IP Recorder Basic – This licenses the system to use the IP Recorder.
- IP Recorder Supervisor – This licenses the number of supervisors that can simultaneously use the IP Recorder.
- IP Recorder Users – This licenses the number of users that can be recorded.

### 60 Day Free License

The 60 Day Free License comes with the GCD-CP10. It allows for all features (except Encryption feature) to be active for 60 days. The count down starts on the first power on and ends at midnight of the 60th day.

- By default, the 60 Day Free License is set to disabled. The 60 day count down starts when the system is initially powered on and continues if the 60 Day Free License is disabled or enabled.
- The GCD-CP10 works for 1440 hours from the first time powered on.
- The clock counts down only when the power supply in the chassis is ON – battery is not in effect.
- If the GCD-CP10 is removed, or the system is powered OFF, the countdown stops.
- Every time the clock is changed, the GCD-CP10 free license (60 days) loses one hour.
- While the free license is active the user can increase the port size of the system to maximum by using Program 90-55.
- The Encryption feature will only work if **Encryption License (0030)** is installed.

### Recovery License

The recovery license turns on all licenses for up to 30 days.

To request a recovery license, go to <http://eip.necunified.com/Default.aspx> and then go to the license portal and select the customer and the location of the GCD-CP10. This can be done only once per GCD-CP10.

### Conditions

- The recovery license can be used only once for each UNIVERGE SV9100 GCD-CP10.
- When the recovery license is generated, it gives the date that the license ends (30 days includes the day generated).

- If the date is changed in Program 10-01-XX, while the license is in effect, to a date before the generated date it subtracts one day from the recovery license.
- If the date is changed in Program 10-01-XX, while the license is in effect, to a date after the generated date, it runs until the End Date specified when the License was generated.
- If the date is changed in Program 10-01-XX, while the license is in effect, to a date after the End Date specified when the License was generated, the system resets when it is applied (transfer key pressed), not when exiting program mode.
- When the System time turns to midnight of the End Date, the system resets and comes back with no licenses.
- The recovery license can be activated only from PCPro or WebPro, not a multiline terminal.
- If any GCD-CP10 license is activated when the recovery licensing is being used, the GCD-CP10 license resets with only the activated license(s).

## Temporary License

### Description

Temporary License activates all valid feature licenses and all port maximum licenses. Temporary License is programmed using Telephone programming only. Web/PC pro can be used when verifying the settings.

The Temporary License can be set up to a maximum number of 10 days.

### Conditions

- Temporary License activates all feature licenses (except the Encryption feature) and all port maximum licenses.
- When the number of days for the temporary license is assigned, system reset is required for the license to take affect.
- When the number of the date is 0 (disable), the number can be set (1~10). When the number of the date is 1~10, the date can be set to 0 (disable) only.
- The date counter of the temporary license is decreased one day at twelve o'clock midnight of each day. When the number of set date expires, the temporary license is cleared at twelve o'clock midnight of the next day.
- When the system date is changed, the date counter of the temporary license is cleared. As a result, the temporary license is cleared at twelve o'clock midnight of the next day.
- When the temporary license is cleared, the system reboots automatically at twelve o'clock midnight of the next day.
- The temporary license is cleared after a cold reset (default).
- When the temporary license is cleared, the Normal license/Campaign license is not cleared.
- When the Normal license / Campaign license is registered, the temporary license remains valid. The temporary license stays valid until the expiration date, then after a system reboot Normal License / Campaign License is valid.
- When a Free License is valid (Program 90-55-01); the temporary license cannot be set. If a Free license is set during the period the temporary license is valid, the temporary license is cleared, but the system does not reboot.
- The Encryption feature will only work if **Encryption License (0030)** is installed.

### Default Settings

60 Day Free License is enabled.

## System Availability

### Terminals

None

### Required Component(s)

Refer to the particular feature for required component(s)

## Related Features

### ↳ Programming from a Multiline Terminal

## Guide to Feature Programming

The **Level 1**, **Level 2** and **Level 3** columns indicate the programs that are assigned when programming this feature in the order they are most commonly used. These levels are used with PCPro and WebPro wizards for feature programming.

- Level 1 – these are the most commonly assigned programs for this feature.
- Level 2 – these are the next most commonly assigned programs for this feature.
- Level 3 – these programs are not often assigned and require an expert level working knowledge of the system to be properly assigned.

Program Number	Program Name/Description	Input Data	Default	Level		
				1	2	3
10-48-01	<b>License Activation – Software Key Code</b> Turn on the license issued from the license server.	20-digit character.	No Setting		✓	
10-48-02	<b>License Activation – Activation Code</b> Turn on the license issued from the license server.	Eight-digit hexadecimal number.	No Setting		✓	
10-48-03	<b>License Activation – Feature Code</b> Turn on the license issued from the license server.	Seven-digit figure.	No Setting		✓	
10-49-01	<b>License File Activation – Save License File on USB Drive</b> Enable the command to save the license file via USB memory which is issued from the license server.	Dial 1 + TRF (Press TRF to cancel)	No Setting		✓	
10-50-01	<b>License Information – License Name</b> Confirm license information that is stored in a system.		No Setting		✓	



Program Number	Program Name/Description	Input Data	Default	Level		
				1	2	3
10-50-02	<b>License Information – License Quantity</b> Confirm license information that is stored in a system.	0 ~ 32767	No Setting		✓	
10-50-03	<b>License Information – Free License Quantity</b> Confirm license information that is stored in a system.	0 ~ 32767	No Setting		✓	
10-50-04	<b>License Information – Free License Remaining Days</b> Confirm license information that is stored in a system.	0 ~ 9999	No Setting		✓	
10-52-01	<b>Free/Demo License Information – Remaining Days of Free/Demo License</b> Display information on free of charge/Demo license.	0 ~ 9999	No Setting		✓	
90-37-01	<b>Set Temporary License – Set Number of Days for Temporary License</b> Use to set the effective days of the temporary license ➡ <i>Requires system reset to take affect.</i>	00 ~ 10 Days 0 = Temporary License is invalid	0		✓	
90-55-01	<b>Free License Select – Start Free License</b> Validate the Free License.	0 = Off 1 = On	0	✓		

Table 2-81 License Information

Feature Code	Item Name	Feature Name (WebPro/PCPro)	Min	Max	Note
0002	SV9100 NETLINK NODE LIC-01	NetLink	1	49	This license number is determined according to number of secondary sites. For example, if you have one (1) Primary and three (3) Secondary sites networked; three (3) licenses are needed. All licenses are activated at the Primary site.  With each "SV9100 NETLINK NODE LIC-01" you receive (32) "SV9100 IP RESOURCE- LIC 01" licenses.
0007	SV9100 HM LIC	Hotel/Motel		On/Off	–
0017	SV9100 REMOVE LIC			On/Off	–
0030	SV9100 ENCRYPTION LIC	Encryption		On/Off	–
0031	SV9100 NAT TRAVERSAL LIC	NAT Traversal		On/Off	–
0041	SV9100 XMLPRO LIC	XML Pro		On/Off	–
0042	SV9100 VIDEO MCU LIC	Video MCU		On/Off	–

Table 2-81 License Information (Continued)

Feature Code	Item Name	Feature Name (WebPro/PCPro)	Min	Max	Note
0046	SV9100 PMS LIC	PMS	On/Off		–
0047	SV9100 REMOTE CONF LIC-01	Remote Conference	1	20	–
0048	SV9100 HW MIGRATION LIC	H/W migration	On/Off		–
0049	SV9100 MULTI-DEVICE	Multi-Device	1	512	–
0080	SV9100 WEB VIDEO CONFERENCE	Video Conference with WebRTC	1	32	–
0111	SV9100 1ST PARTY CTI LIC-01	1st Party CTI (Ethernet)	1	256	1st Party CTI (Ethernet) xx client
0112	SV9100 3RD PARTY CTI-LIC 01	3rd Party CTI Client	0	999	–
0123	SV9100 OAI LIC	OAI Interface	On/Off		–
0300	SV9100 RESOURCE - LIC 01	System Port	1	1296	Required for each port TDM/IP station port, trunk port, etc., that connects to the system.
0411	SV9100 VERSION LIC (R1)	Version R1	On/Off		–
0413	SV9100 VERSION LIC (R3)	Version R3	On/Off		–
0414	SV9100 VERSION LIC (R4)	Version R4	On/Off		–
0415	SV9100 VERSION LIC (R5)	Version R5	On/Off		–
0416	SV9100 VERSION LIC (R6)	Version R6	On/Off		–
1001	SV9100 INMAIL VRS PORT-LIC 01	VRS Port	1	16	–
1012	SV9100 INMAIL VM BOX-LIC 01	VM Box	1	896	–
1014	SV9100 INMAIL EMAIL CLIENT-LIC 01	InMail Email Client	1	896	–
1402	SV91/93 UM8000 FAX PORT-LIC 01	UMS FAX Port	1	4	1 Port FAX
1403	SV91/93 UM8000 TTS PORT-LIC 01	UMS TTS Port	1	6	1 Port of Text-to-Speech language for Microsoft outlook activation license.
1404	SV91/93 UM8000 UMS CLIENT-LIC 01	UMS Client	1	896	This license provides the following for UM8000 Mail: – One Subscriber or Guest Mailbox. – One View App Session, (Supports View Mail, View Call Plus, VMM (Outlook), VML (Lotus Notes), VMG (GroupWise) and Web Mailbox clients Manager.)
1406	SV91/93 UM8000 SYSTEM LANG-01 LIC	UMS Multi-Language	1	25	1 Language activation License.
1407	SV91/93 UM8000 HOSPITALITY & PMS LIC	UMS Hospitality and PMS	On/Off		Hospitality and PMS activation license.
1408	SV91/93 UM8000 HOSPITALITY LANG-LIC 01	UMS Hospitality Language	1	10	1 Hospitality Language activation license.
1409	SV91/93 UM8000 AMIS NETWORK LIC	UMS Amis/Plus Net	On/Off		–

Table 2-81 License Information (Continued)

Feature Code	Item Name	Feature Name (WebPro/PCPro)	Min	Max	Note
1410	SV91/93 UM8000 TTS LANG-LIC 01	UMS TTS Language	1	10	1 Port of Text-to-Speech language activation license.
2002	SV9100 CONTACT CENTER AGENT-LIC 01	ACD Client	1	896	–
2101	SV9100 CONTACT CENTER P-EVENT LIC	ACD P-event	On/Off		
2102	SV9100 CONTACT CENTER-MIS LIC	ACD-MIS Basic	On/Off		–
2103	SV9100 CONTACT CENTER RT-REPORTING-LIC 01	ACD-MIS Monitor	1	16	–
2104	SV9100 CONTACT CENTER MIS AGENT-LIC 01	ACD-MIS Agent	1	197	–
2105	SV9100 CONTACT CENTER SKILL/CID BASE LIC	ACD Advance	On/Off		–
2107	SV9100 INCONTROL CR PKG LIC	InControl Server	On/Off		–
3000	SV91/93/95 CA STATION PKG LIC-20	CA-Basic	On/Off		–
3001	SV91/93/95 CA STATION PKG LIC-256	CA-256 Station	On/Off		–
3002	SV91/93/95 CA UPG LIC-20/256	CA-Up 20 to 256	On/Off		–
3003	SV91/93/95 CA NETWORK CLIENT PACK-LIC 05	CA-Network Client	1	999	–
3004	SV91/93/95 CA ADD REMOTE SITE-LIC 01	CA-Add Remote Site	1	999	–
3005	SV91/93/95 CA ADD REMOTE SOFTWARE-LIC 01	CA-Remote Site Soft	1	999	–
3006	SV91/93/95 CA SYS TRAFFIC ANALYSIS LIC	CA-Traffic Analys	On/Off		–
3007	SV91/93/95 CA SYS PMS INTEGRATION LIC	CA-PMS Integratio	On/Off		–
3008	SV91/93/95 CA WEB REPORTING-LIC 05	CA-Web Reporting	On/Off		–
3013	SV91/93/95 CA ADDITIONAL STATION LIC-256	CA-Add Stations	1	256	–
3014	SV9100 CA E911-REPORTING-LIC	CA-E911 Reporting	1	999	–
3200	SV91/93 IP RECORDER - Basic Package	IP REC BASIC PAC	On/Off		–
3201	SV91/93 IP RECORDER - Basic Supervisor Capacity	REC BASIC SUPV	1	256	–
3202	SV91/93 IP RECORDER - Basic Port Capacity	REC BASIC PORT	1	256	–

Table 2-81 License Information (Continued)

Feature Code	Item Name	Feature Name (WebPro/PCPro)	Min	Max	Note
3203	SV91/93 IP RECORDER - IP Recorder-LIC 01	IP REC ADD 256	1	256	
3204	SV91/93 IP RECORDER - Call Scoring-LIC 01	IP REC CALLSCORING	1	999	
3205	SV91/93 IP RECORDER - Reporting-LIC	IP CALL REPORTING	On/Off		
3210	SV91/93/95 IP/DIGITAL-REPORT-LIC 01	VSR-IP Port			Includes feature codes 3210 and 3211.
3211	SV91/93/95 IP/DIGITAL-ENCRYPTION-LIC 01	VSR-Encrypt			–
3212	SV91/93/95 MANAGER PORT-LIC 01	VSR-Manager			–
3213	SV91/93/95 IP/DIGITAL-REPORT-LIC 01	VSR-Reporter			–
3214	SV91/93/95 IP/DIGITAL ARCHIVER PORT-LIC 01	VSR-Archive			–
3300	SV91/93 E911 ESN Suite-LIC	ESN Registry	On/Off		–
3301	SV91/93 E911On-Site Monitor-LIC	ESN Site Monitor	1	9999	–
3302	SV91/93 E911 ALARM CLIENT ADD-ON -LIC	ESN Alarm Client	1	9999	–
3303	SV91/93 E911 Call Notify-Addon-LIC	ESN Call Notify	1	9999	–
3400	SV9100 CTI OCX LIC	CTI-OCX	On/Off		–
3512	SV9100 INGUARD LIC	InGuard	On/Off		–
3513	SV9100 LUA PMS LIC	LUA InPMS	On/Off		–
3514	SV9100 LUA PHONEPRO LIC	LUA PhonePro	On/Off		–
5001	SV9100 IP TRUNK-LIC 01	IP Trunk	1	400	–
5012	SV9100 NETWORKING-LIC 01	K-CCIS over IP	1	400	Each system need this license to specify suitable K-CCIS over IP channel (Trunk) number.
5050	DT820 GIGABIT	DT820 Gigabit	1	896	For DT820 software version 2 telephones only. Each telephone must be manually set to get this license from the SV9100.
5051	DT820 EXT LK 16	DT820 Ext LK 16	1	896	
5052	DT820 EXT LK 32	DT820 Ext LK 32	1	896	
5091	SV9100 NETWORKING OVER IP-LIC 01	Networking over IP	1	128	
5103	SV9100 IP RESOURCE-LIC 01	VoIP Channel	1	12800	–
5111	SV9100 IP PHONE-LIC 01	IP Terminal	1	896	–
5201	SV9100 MOBILE EXT-LIC 01	Mobile Extension	1	896	–

Table 2-81 License Information (Continued)

Feature Code	Item Name	Feature Name (WebPro/PCPro)	Min	Max	Note
5301	SV9100 UCS SOFTPHONE CLIENT-LIC01	UCS SoftPhone Client	1	256	–
5303	SV9100 UCS SOFTPHONE E CLIENT-LIC01	UCS SoftPhone Enhance	1	256	–
5304	SV9100 UCS ATTENDANT CLIENT-LIC 01	UCS Attendant Client	1	512	–
5305	SV9100 UCS CLIENT-LIC01	UCS Client	1	256	–
5309	SV9100 UCS ADVANCED SERVICE-LIC 01	UCS Enhancement I	1	512	–
5310	SV9100 UCS CRM INTEGRATION-LIC 01	UCS CRM Integration	1	256	This will support external CRM applications. Refer to the UC Suite Installation manual for further details.
5311	SV9100 MOBILE PRESENCE LIC	UCS Mobile Presence	On/Off		–
5312	SV9100 UCS VOICEMAIL INT-LIC 01	UCS InMail Integration	1	128	Access to InMail function from UC Suite. Client base license.
5313	SV9100 UCS WEB CLIENT-LIC 01	UCS Web Client	1	512	–
5320	SV9100 UCS VERSION LIC(R1)	UCS Version 1	On/Off		–
5327	SV9100 INCONTROL ADDON-01 LIC	InControl Addon	On/Off		–
6200	PVA-CCIS PORT LIC	PVA-CCIS Port	4	400	–
6201	SV9100 PVA-PMS US LIC	PVA-PMS	On/Off		–
6300	RGA CONF PORT-LIC 08	RGA Conference	8	32	–
6301	RGA CONF ENH I-LIC	RGA-CNF ENH I	On/Off		
6302	RGA CONF ENH II-LIC	RGA-CNF ENH II	On/Off		
6303	RGA CONF ENH III-LIC	RGA-CNF ENH III	On/Off		
6304	RGA CONF MULTI LANG-LIC 01	RGA-CNF Multi Lang	1	60	

## Operation

There are four different ways to activate the licenses in the system:

### Manual Enter Software Key Code:

1. In Program 10-48-01 enter the Software Key Code.
2. In Program 10-48-02 enter the activation code.

3. In Program 10-48-03 enter the feature code(s) in the Software Key Code.
4. In Program 10-48-03 hit the Submit Softkey.

**Manually Load the License File via the USB Drive:**

1. Manually register the software key.
2. Save the License file to the USB Drive.
3. Install the USB Drive onto the GCD-CP10.
4. In Program 10-49-01 assign to 1 and then hit transfer.  
◇ *Multiple License files can be loaded at the same time.*

**Upload the License File via WebPro/PCPro:**

1. Manually register the software key.
2. Save the license file.
3. Connect to the system.
4. Go to the Feature Activation screen.
5. Click on Load File.
6. Select the location of the license file to upload.

**Auto Register the License for the System:**

1. Connect to the system.
2. Go to the Feature Activation screen.
3. Enter email Address and Password.
4. Add Software Key code(s).  
◇ *If left blank, it registers all attached licenses for the Hardware Key code.*
5. Click on Auto Register.

## Line Load Control

### Description

The Line Load Control feature allows the system to be configured so that resource use is limited to certain stations during very high system load conditions. This allows only high priority phone access to phone system resources during very high CPU load conditions.

If enabled, when the configured low level threshold is reached the system will not allow restricted phones to make or receive internal or external calls. Calls that are in progress are not affected, but when a phone set to be restricted hangs up they will not be able to make or receive calls until the configure threshold to release restriction is reached.

For example, at default the system low lever threshold is set to 90% CPU load and the restriction end threshold is set to 50% CPU load. If the CPU reaches 90% load restriction is enabled for all phones configured in Program 15-01-16 to be restricted. Phones not set to be restricted can still make and receive calls. The restricted phones will stay in restriction status until the CPU load drops below 50%.

### Conditions

- If the low or high level restriction is triggered any phone set to be restricted in Program 15-01-16 will not be able to make or receive calls including 911 calls.
- At default all extensions are set to restrict in Program 15-01-16.
- The surveillance interval of CPU load factor is fixed at 1 second.
- When the CPU load factor exceeds value of Program 90-73-04 for the number of seconds set in Program 90-73-05, the high level restriction is triggered.
- When the CPU load factor exceeds value of Program 90-73-02 for the number of seconds set in Program 90-73-03, the low level restriction is triggered.
- If the CPU load factor drops below the value set in Program 90-73-06 during low level restriction or high level restriction, the restriction will end.
- The Line Load Control feature is automatic once enabled and cannot be started or ended manually.
- The alarm report provides the Start time and End time of restriction.
- The Line Load Control feature is enabled and configured system wide but restriction is set on a per phone basis.

### Default Settings

Disabled

## System Availability

### Terminals

All Terminals

### Required Component(s)

- GCD-CP10
- 0411 – SV9100 Version Lic (R1)
- 0300 – SV9100 Resource Lic

## Related Features

None

## Guide to Feature Programming

The **Level 1**, **Level 2** and **Level 3** columns indicate the programs that are assigned when programming this feature in the order they are most commonly used. These levels are used with PCPro and WebPro wizards for feature programming.

- Level 1 – these are the most commonly assigned programs for this feature.
- Level 2 – these are the next most commonly assigned programs for this feature.
- Level 3 – these programs are not often assigned and require an expert level working knowledge of the system to be properly assigned.

Program Number	Program Name/Description	Input Data	Default	Level		
				1	2	3
15-01-16	<b>Basic Extension Data Setup – Line Load Control Extension</b> Enable/Disable an extension user ability to make and receive calls when the Line Load Control feature is triggered. ➤ <i>When enabled, users cannot make or receive internal and external calls including 911 calls if the Line Load Control feature is enabled and triggered.</i>	0 = Disable (Not Restricted) 1 = Enable (Restricted)	0	✓		
90-73-01	<b>Line Load Control – Line Load Control</b> Use this Program to enable or disable Line Load Control feature.	0 = Off 1 = On	0	✓		
90-73-02	<b>Line Load Control – CPU Load Factor (Low Level Restriction)</b> Sets the CPU load factor percentage for low level restriction.	30 - 100%	90%		✓	



Program Number	Program Name/Description	Input Data	Default	Level		
				1	2	3
90-73-03	<b>Basic Extension Data Setup – Surveillance Seconds (Low Level Restriction)</b> Sets the low level surveillance seconds. When the CPU load factor exceeds value of Program 90-73-02 for the number of seconds set in Program 90-73-03 consecutive seconds, the low level restriction is triggered.	1 ~ 10 seconds	6		✓	
90-73-04	<b>Multiline Telephone Basic Data Setup – CPU Load Factor – High Level Restriction</b> Sets the CPU load factor percentage for high level restriction.	30 - 100%	95%		✓	
90-73-05	<b>Multiline Telephone Basic Data Setup – Surveillance Seconds (High Level Restriction)</b> Sets the high level surveillance seconds. When the CPU load factor exceeds value of Program 90-73-04 for the number of seconds set in Program 90-73-05 consecutive seconds, the high level restriction is triggered.	1 ~ 10 seconds	3		✓	
90-73-06	<b>Multiline Telephone Basic Data Setup – CPU Load Factor (High Level Restriction)</b> Sets the CPU load factor required for all restriction levels to end. This Program must be set smaller than Program 90-73-04 and Program 90-73-05.	30 - 100%	50%		✓	

## Operation

None

## Line Preference

### Description

Line Preference determines how a multiline terminal user places and answers calls. Line Preference has two types: Incoming Line Preference or Outgoing Line Preference.

#### Incoming Line Preference

Incoming Line Preference establishes how a multiline terminal user answers calls. When a call rings the multiline terminal, lifting the handset answers either the ringing call (for Ringing Line Preference) or seizes an idle line (for Idle Line Preference). The idle line can provide either Intercom or trunk dial tone (see Outgoing Line Preference below). Ringing Line Preference helps users whose primary function is to answer calls (such as a receptionist). Idle Line Preference is an aid to users whose primary function is to place calls (such as a telemarketer).

#### Outgoing Line Preference

Outgoing Line Preference sets how a multiline terminal user places calls. If a multiline terminal has Outgoing Intercom Line Preference, the user hears Intercom dial tone when they lift the handset. If a multiline terminal has Outgoing Trunk Line Preference, the user hears trunk dial tone when they lift the handset. Outgoing Line Preference also determines what happens at extensions with Idle Line Preference. The user hears either trunk (dial 9) or Intercom dial tone.

#### Auto-Answer of Non-Ringing Lines

With Auto-Answer of Non-Ringing Lines, an extension user can automatically answer trunk calls that ring other extensions (not their own). This would help a user that has to answer calls for co-workers that are away from their desk. When the user lifts the handset, they automatically answer the ringing calls based on Trunk Group Routing programming. The extension user's own ringing calls, however, always have priority over calls ringing other co-worker's extensions.

### Conditions

- If a multiline terminal extension has more than one call ringing its line keys, Ringing Line Preference answers the calls on a first-in first-answered basis.
- DILs do not affect Incoming Line Preference operation.
- Trunks ring extensions according to Ring Group programming.
- If an extension gets trunk dial tone when the user lifts the handset, the system uses the dial 9 routing to select the trunk. This bypasses ARS.

### Default Settings

Enabled

## System Availability

### Terminals

All Multiline Terminals

### Required Component(s)

None

## Related Features

- [Direct Inward Line \(DIL\)](#)
- [Ring Groups](#)
- [Trunk Groups](#)

## Guide to Feature Programming

The **Level 1**, **Level 2** and **Level 3** columns indicate the programs that are assigned when programming this feature in the order they are most commonly used. These levels are used with PCPro and WebPro wizards for feature programming.

- Level 1 – these are the most commonly assigned programs for this feature.
- Level 2 – these are the next most commonly assigned programs for this feature.
- Level 3 – these programs are not often assigned and require an expert level working knowledge of the system to be properly assigned.

Program Number	Program Name/Description	Input Data	Default	Level		
				1	2	3
14-05-01	<b>Trunk Group – Trunk Group Number</b> For Auto-Answer of Non-Ringing Lines, assign trunks to trunk groups. This is part of Trunk Group Routing programming.	Trunk Port 1 ~ 400 Group Number 0 ~ 100 Priority 1 ~ 400	Default = Trunks 1 ~ 400 assigned to trunk group 1 with priorities equal to the trunk number. Trunk 1 = Priority 1 Trunk 400 = Priority 400.	✓		

Program Number	Program Name/Description	Input Data	Default	Level		
				1	2	3
14-06-01	<b>Trunk Group Routing – Priority Order Number</b> Set the priority order number (1 ~ 4).	0 = Not Specify 1 ~ 100: (Trunk Group Number) 100 ~ 150: (100 + Networking System Number) 1001 ~ 1100: (1000 + Route Table Number)	Route 1, Order Number 1 = 1 (Trunk Group 1) Order Numbers 2, 3, 4 = 0 (Not Specified) All Other Routes (2 ~ 100) and Order Numbers (1 ~ 4) = 0 (Not Specified)	✓		
14-07-01	<b>Trunk Access Map Setup</b> For Outgoing Line Preference and Auto-Answer of Non-Ringing Lines, set up the Trunk Access Maps.	0 = No access 1 = Outgoing access only 2 = Incoming access only 3 = Access only when trunk on Hold 4 = Outgoing access and access when trunk on Hold 5 = Incoming access and access when trunk on Hold 6 = Incoming and Outgoing access 7 = Incoming access, outgoing access and access when trunk on Hold Trunk Access Maps: 1 ~ 400	Access Maps 1 ~ 400 = Trunk Ports 1 ~ 400 assigned with option 7 access (incoming and outgoing access and access when trunk is on Hold).		✓	
15-01-02	<b>Basic Extension Data Setup – Outgoing Trunk Line Preference</b> Turn Off or On an Outgoing Trunk Line Preference for extensions.	0 = Off 1 = On	0	✓		
15-02-10	<b>Multiline Telephone Basic Data Setup – Ringing Line Preference for Trunk Calls</b> Enable Idle or Ringing Line Preference for trunk calls. Program 22-01-01 sets Intercom (0) or trunk (1) call priority.	0 = Idle 1 = Ringing	1	✓		
15-06-01	<b>Trunk Access Map for Extensions</b> For Outgoing Line Preference and Auto-Answer of Non-Ringing Lines, assign trunk Access Maps to extensions.	Trunk Access Maps: 1 ~ 400	1		✓	
20-10-07	<b>Class of Service Options (Answer Service) – Automatic Off-Hook Answer</b> Turn Off or On an extension user ability to use Universal Auto Answer (no service code required).	0 = Off 1 = On	COS 1 ~ 15 = 0		✓	
22-01-01	<b>System Options for Incoming Calls – Incoming Call Priority</b> Determine if Intercom calls or trunk calls have answer priority when both are ringing simultaneously.	0 = Intercom call priority 1 = Trunk call priority	1		✓	

Program Number	Program Name/Description	Input Data	Default	Level		
				1	2	3
22-04-01	<p><b>Incoming Extension Ring Group Assignment</b></p> <p>Assign extensions to ring groups. Auto-Answer for Non-Ringing Lines only works for trunks that do not ring an extension.</p>	Maximum of eight digits.	Extensions 101 ~ 108 (first eight ports) ring for incoming Ring Group 1 calls. No other extensions ring for incoming Ring Group 1 calls.	✓		
22-05-01	<p><b>Incoming Trunk Ring Group Assignment</b></p> <p>Assign trunks to ring groups. Auto-Answer for Non-Ringing Lines only works for trunks that do not ring an extension.</p>	Trunks 1 ~ 400 Incoming Group Number for Day/Night Mode (1 ~ 8): 0 = (No Setting) 001 ~ 100 = (Incoming Group) 102 = (In-Skin/ External Voice Mail or InMail)	1		✓	
23-03-01	<p><b>Universal Answer/Auto Answer</b></p> <p>Let an extension user automatically answer trunk calls that ring other extensions. When the user lifts the handset, they automatically answer the ringing calls based on Trunk Group Routing programming (defined in Program 14-06).</p>	Day/Night Mode 1 ~ 8 Route Table Number 0 ~ 100	0		✓	

## Operation

### Ringling Trunk or intercom (ICM) call:

Lift the handset or press **Speaker**.

- ◇ *The setting assigned for Program 15-02-10 and Program 22-01-01 determines which call is answered first.*

# Long Conversation Cutoff

## Description

For incoming and outgoing central office calls, each trunk can be programmed to disconnect after a defined time. The timer begins when the trunk is seized and disconnects the call after the time expires.

When used with the Warning Tone for Long Conversation feature, the system can provide a warning tone on outgoing trunks calls before the call is disconnected.

### Conditions

- Long Conversation Cutoff can disconnect incoming and outgoing CO calls after a set time.
- Long conversation cutoff is controlled separately for DISA and Tie Lines.
- Using the Warning Tone for Long Conversation feature allows users on outgoing calls to hear a warning tone prior to the call disconnecting.

### Default Settings

Disabled

## System Availability

### Terminals

All Terminals

### Required Component(s)

None

## Related Features

- ➔ **Central Office Calls, Answering**
- ➔ **Central Office Calls, Placing**
- ➔ **Direct Inward System Access (DISA)**
- ➔ **Multiple Trunk Types**
- ➔ **Warning Tone for Long Conversation**

## Guide to Feature Programming

The **Level 1**, **Level 2** and **Level 3** columns indicate the programs that are assigned when programming this feature in the order they are most commonly used. These levels are used with PCPro and WebPro wizards for feature programming.

- Level 1 – these are the most commonly assigned programs for this feature.
- Level 2 – these are the next most commonly assigned programs for this feature.
- Level 3 – these programs are not often assigned and require an expert level working knowledge of the system to be properly assigned.

Program Number	Program Name/Description	Input Data	Default	Level		
				1	2	3
14-01-14	<b>Basic Trunk Data Setup – Long Conversation Cutoff</b> Enable/Disable a trunk ability to disconnect incoming and outgoing central office calls automatically.	0 = Disable 1 = Enable	0	✓		
14-01-15	<b>Basic Trunk Data Setup – Long Conversation Alarm Before Cut Off</b> Enable/Disable the Long Conversation Alarm for each trunk.	0 = Disable 1 = Enable	0	✓		
20-06-01	<b>Class of Service for Extensions</b> Assign a Class of Service (1 ~ 15) to extensions.	Day Night/Mode: 1 ~ 8 Class of Service of Extensions (1 ~ 15)	Extension port 101 = Class 15 All other extension port = Class 1		✓	
20-13-02	<b>Class of Service Options (Supplementary Service) – Long Conversation Cutoff (Incoming)</b> Turn Off or On an extension user ability to use Long Conversation Cutoff for incoming calls.	0 = Off 1 = On	COS 1 ~ 15 = 0	✓		
20-13-03	<b>Class of Service Options (Supplementary Service) – Long Conversation Cutoff (Outgoing)</b> Turn Off or On an extension user ability to use Long Conversation Cutoff for outgoing calls.	0 = Off 1 = On	COS 1 ~ 15 = 0	✓		
20-21-03	<b>System Options for Long Conversation – Long Conversation Cutoff for Incoming Call</b> Enter the time the system waits before disconnecting incoming trunks.	0 ~ 64800 seconds	0	✓		
20-21-04	<b>System Options for Long Conversation – Long Conversation Cutoff for Outgoing Call</b> Enter the time the system waits before disconnecting outgoing trunks.	0 ~ 64800 seconds	0	✓		

## Operation

This feature is automatic once it is programmed.



## Loop Keys

### Description

Loop Keys are uniquely programmed function keys that simplify placing and answering trunk calls. There are three types of Loop Keys: Incoming Only, Outgoing Only and Both Ways.

#### **Incoming Only Loop Keys**

Incoming Only loop keys are for answering trunk calls. An extension can have an incoming loop key for a specific trunk group (fixed) or a “catch all” loop key for any trunk group (switched). Fixed loop keys allow an extension user to tell the type of call by the ringing key. Switched loop keys are ideal for an extension with a large number of feature keys. In addition, switched loop keys are a destination for any trunk not on a line key or fixed loop key. Without a switched loop key, calls not appearing on a line key or fixed loop key will ring only the Answer key. Incoming Only loop keys also receive Transferred trunk calls.

#### **Outgoing Only Loop Keys**

Outgoing Only loop keys are for placing trunk calls. An extension can have outgoing loop keys for a specific trunk group or for ARS access. When a user presses the loop key, they get dial tone from the first available trunk in the group (or from ARS if programmed). Outgoing Only loop keys help ensure that an extension will always have a key available for placing calls.

#### **Both Ways Loop Keys**

Both Ways loop keys combine the functions of both Incoming Only and Outgoing Only loop keys. Both Ways loop keys work well for extension users that handle a moderate amount of calls and don't separate keys for incoming and outgoing calls. Both Ways loop keys also receive Transferred trunk calls. An extension can have many loop keys - of any type. You can program an operator, for example, with four loop keys for incoming calls and four for outgoing calls. Once a loop key call is set up, the user can handle it like any other trunk call. For example, the user can place the call on Hold, Transfer it to a co-worker or send it to a Park Orbit. An incoming call will ring the first available loop key, beginning with the lowest numbered key. If keys 1-3 are loop keys, for example, the first incoming call rings key 1. If key 1 is busy, the next call rings key 2. If keys 1 and 2 are busy, the next call rings key 3. If all three keys are busy, additional incoming calls queue for the first available key. The terminal display will show “WAITING - LOOP KEY” if the user presses a loop key when there are additional calls waiting.

### Conditions

- Loop Keys can only be assigned or used when Program 20-02-23 is set to UX5000 (1).
- A system can use either CAP keys or Loops keys.
- When only SV telephones are installed, CAP key mode must be used.
- When SV telephones and UX telephones are installed in the same system, CAP keys are required.

- When only UX telephones are installed, CAP keys (Program 20-02-23 = 0) or Loop keys (Program 20-02-23 = 1) can be used.

### Default Settings

None

## System Availability

### Terminals

UX5000 Terminals only

### Required Component(s)

None

## Related Features

- ↳ **Automatic Route Selection (ARS)**
- ↳ **Central Office Calls, Answering**
- ↳ **Central Office Calls, Placing**
- ↳ **Direct Inward Dialing (DID)**
- ↳ **Direct Inward Line (DIL)**
- ↳ **Direct Inward System Access (DISA)**
- ↳ **Off-Hook Signaling**
- ↳ **Programmable Function Keys**
- ↳ **Ring Groups**

## Guide to Feature Programming

The **Level 1**, **Level 2** and **Level 3** columns indicate the programs that are assigned when programming this feature in the order they are most commonly used. These levels are used with PCPro and WebPro wizards for feature programming.

- Level 1 – these are the most commonly assigned programs for this feature.
- Level 2 – these are the next most commonly assigned programs for this feature.
- Level 3 – these programs are not often assigned and require an expert level working knowledge of the system to be properly assigned.

Program Number	Program Name/Description	Input Data	Default	Level		
				1	2	3
14-05-01	<b>Trunk Group – Trunk Group Number</b> For Auto-Answer of Non-Ringing Lines, assign trunks to trunk groups. This is part of Trunk Group Routing programming.	Trunk Port 1 ~ 400 Group Number 0 ~ 100 Priority 1 ~ 400	Default = Trunks 1 ~ 400 assigned to trunk group 1 with priorities equal to the trunk number. Trunk 1 = Priority 1 Trunk 400 = Priority 400.		✓	
14-07-01	<b>Trunk Access Map Setup</b> For Outgoing Line Preference and Auto-Answer of Non-Ringing Lines, set up the Trunk Access Maps.	0 = No access 1 = Outgoing access only 2 = Incoming access only 3 = Access only when trunk on Hold 4 = Outgoing access and access when trunk on Hold 5 = Incoming access and access when trunk on Hold 6 = Incoming and Outgoing access 7 = Incoming access, outgoing access and access when trunk on Hold Trunk Access Maps: 1 ~ 400	Access Maps 1 ~ 400 = Trunk Ports 1 ~ 400 assigned with option 7 access (incoming and outgoing access and access when trunk is on Hold).		✓	
15-06-01	<b>Trunk Access Map for Extensions</b> Assign trunks to trunk groups. In general, loop keys access trunks within specific trunk groups.	Trunk Access Maps: 1 ~ 400	1		✓	
15-07-01	<b>Programmable Function Keys</b> Program function keys as trunk group/loop keys (*02 or *05). For additional data, enter 0 (incoming only), 1 (outgoing only) or 2 (both ways). Use Programs 15-13-01 or 15-13-02 to define the trunk groups used.	Line Key 1 ~ 48 0 ~ 99 (Normal Function Code 751 by default) *00 ~ *99 (Appearance Function Code) (Service Code 752 by default)	Refer to the Programming Manual for default values.	✓		

Program Number	Program Name/Description	Input Data	Default	Level		
				1	2	3
15-13-01	<b>Loop Key Data – Outgoing</b> Assign trunk groups for outgoing loop keys (0=ARS, Trunk Groups 1-100). Selecting “0” for ARS should only be used when ARS is enabled in Program 26-01-01 or it could cause the loop key to lock up.	0 ~ 8 or 0 ~ 100 0 = Assigns the Loop Key for ARS 1 ~ 100 = Assigns the Loop Key to the trunk group specified.	Programmable Function Key Number 01 ~ 32: Outgoing Option - 0 (Assigns the Loop Key for ARS)	✓		
15-13-02	<b>Loop Key Data – Incoming</b> Assign trunk groups for incoming loop keys (0=all Trunk Groups, Trunk Groups 1-100).	0 ~ 8 or 0 ~ 100 0 = Assigns the Loop Key to all trunk groups 1 ~ 100 = Assigns the Loop Key to the trunk group specified.)	Programmable Function Key Number 01 ~ 32: Incoming Option - 0 (Assigns the Loop Key to all trunk groups)	✓		
20-02-23	<b>System Options for Multiline Telephones – UX5000 Phone Operation Mode</b> Selects the Loop Key operation like the UX5000 terminal, or the CAP Key operation like the SV9100 terminal.	0 = Original Operation Mode (CAP Key) 1 = UX5000 Special Operation Mode (Loop Key)	0	✓		
20-07-10	<b>Class of Service Options (Administrator Level) – Programmable Function Key Programming (Appearance Level)</b> Turn Off or On an extension user ability to program the Appearance function keys using Service Code 752. ➡ <i>When programming a feature as a Programmable Function Key, refer to Program 15-07-01 in the UNIVERGE SV9100 Programming Manual.</i>	0 = Off 1 = On	COS 1 ~ 15 = 1		✓	
22-04-01	<b>Incoming Extension Ring Group Assignment</b> Assign extensions (up to 48) to Ring Groups. Calls ring extensions according to Ring Group programming. There are 100 available ring groups.	Maximum of eight digits.	Extensions 101 ~ 108 (first eight ports) ring for incoming Ring Group 1 calls. No other extensions ring for incoming Ring Group 1 calls.		✓	
22-05-01	<b>Incoming Trunk Ring Group Assignment</b> Assign trunks to incoming Ring Groups. Use this program to assign Normal Ring Trunks (Program 22-02) to Incoming Ring Groups (Program 22-04).	Trunks 1 ~ 400 Incoming Group Number for Day/Night Mode (1 ~ 8): 0 = (No Setting) 001 ~ 100 = (Incoming Group) 102 = (In-Skin/ External Voice Mail or InMail)	1		✓	

## Operation

### To place a call on a loop key:

1. Press the outgoing or both ways loop key.
  - ◇ *You hear dial tone and the key lights green.*
2. Dial the number.

### To answer a call on a loop key:



— Listen for ringing or look for a flashing loop key.

NOTE

1. Press loop key.
  - ◇ *The key lights green and you connect to the call.*
  - ◇ *If there are additional calls waiting to be answered, your display shows: [WAITING - LOOP KEY]*

### To program a loop key:

1. Press the **SPK** key.
2. Dial **752**.
3. Press the key you want to program as a loop key.
4. Dial **\*05**.
5. Dial the loop key type:
  - 0 = Incoming only
  - 1 = Outgoing only
  - 2 = Both ways (incoming and outgoing)
6. Dial the loop key routing option for incoming, outgoing, or incoming and outgoing calls:
  - ◇ *If you selected option 2 in step 5 above, enter the incoming Trunk Group followed by the outgoing Trunk Group.*
7. Press **SPK** to hang up.



### Description

The UNIVERGE SV9100 system has several utilities to assist in troubleshooting and diagnosing problems both during and after installation.

PCPro can remotely access the UNIVERGE SV9100 for maintenance and diagnostics. Within PCPro, the debug terminal can be accessed to monitor the systems activity and logging. PCPro also has built-in reports that can display alarm data. If need be, an option in PCPro allows the technician to reset or initialize the system remotely. If the technician determines the problem is isolated to a specific slot, PCPro can reset only the slot in question.

The SV9100 Maintenance manual contains a number of flow charts to help technicians diagnose and resolve problems that may arise during and after the installation of the UNIVERGE SV9100 system.

### Side Tone Auto Setup

Per each analog trunk (or all analog trunks) the most suitable CODEC Filter setting for Program 81-07 and Program 81-17 can be automatically adjusted using Programs 90-68-01 and 90-68-02.

During the trunk measurement process, the following LCD indications are provided:

- During measurement: Measurement (x/4)  
x = number of measurements
- Measure complete: Complete  
Error condition: Error  
Trunk busy: Busy

After successful measurement, the option to copy the same settings to all analog trunks is shown.



NOTE

*Side Tone Auto Setup available when the system is in an idle condition.*

### Conditions

None

## Default Settings

Enabled

## System Availability

### Terminals

None

### Required Component(s)

None

## Related Features

None

## Guide to Feature Programming

None

## Operation

None



## Meet Me Conference

### Description

With Meet Me Conference, an extension user can set up a Conference with their current call and up to 31 other internal or external parties. Each party joins the Conference by dialing a Meet Me Conference code. Meet Me Conference lets extension users have a telephone meeting – without leaving the office.

The GCD-CP10 provides two blocks of 32 conference circuits (or three blocks of 32 conference circuits when the modem function is not used), allowing each block to have any number of internal or external parties conferenced up to the block limit of 32.

#### Conditions

None

#### Default Setting

Enabled

### System Availability

#### Terminals

All Multiline Terminals

#### Required Component(s)

None

### Related Features

- ↳ [Conference](#)
- ↳ [Meet Me Paging](#)
- ↳ [Programmable Function Keys](#)

## Guide to Feature Programming

The **Level 1**, **Level 2** and **Level 3** columns indicate the programs that are assigned when programming this feature in the order they are most commonly used. These levels are used with PCPro and WebPro wizards for feature programming.

- Level 1 – these are the most commonly assigned programs for this feature.
- Level 2 – these are the next most commonly assigned programs for this feature.
- Level 3 – these programs are not often assigned and require an expert level working knowledge of the system to be properly assigned.

◇ For additional programming for Paging, refer to the features [Paging, External on page 2-1257](#) and [Paging, Internal on page 2-1267](#).

Program Number	Program Name/Description	Input Data	Default	Level		
				1	2	3
15-07-01	<b>Programmable Function Keys</b> Assign function keys for Conference (code 07).	Line Key 1 ~ 48 0 ~ 99 (Normal Function Code 751 by default) *00 ~ *99 (Appearance Function Code) (Service Code 752 by default)	Refer to the Programming Manual for default values.		✓	
20-06-01	<b>Class of Service for Extensions</b> Assign a Class of Service (1 ~ 15) to an extension.	Day Night/Mode: 1 ~ 8 Class of Service of Extensions (1 ~ 15)	Extension port 101 = Class 15 All other extension port = Class 1		✓	
20-10-06	<b>Class of Service Options (Answer Service) – Meet-Me Conference and Paging</b> Turn Off or On an extension user ability to use Meet-Me Conference and Paging.	0 = Off 1 = On	COS 1 ~ 15 = 1		✓	
31-01-04	<b>System Options for Internal/External Paging – Privacy Release Time</b> Set the Privacy Release Time. After the user initiates Meet Me Conference, the system waits this interval for the Paged party to join the conversation.	0 ~ 64800 seconds	90		✓	

## Operation

### Meet Me Conference via Privacy Release Key

#### To join a Voice Call Conference (if invited):

1. After Conference request, press indicated line key.
  - ◇ *A Conf indication is displayed on both telephones.*
  - ◇ *A Trunk with privacy release or Voice Call Conference blinks.*

#### To exit a Voice Call Conference without affecting other parties:

1. Press **Speaker** to hang up.

#### To toggle between Private and Non-private mode:

1. Press the Meet Me Conference key (Program 15-07-01, SC 751: 32).

- OR -

Press the Trunk Line key. (Toggles from Non-private to Private. To return to Non-private, the Meet Me Conference key above must be pressed).

### Meet Me External Conference

#### To Make a Meet Me Conference via External Page:

##### Multiline Terminal

1. While on a call, press **Conf** softkey.
2. Dial **\*1** and the Combined Paging Zone code **1~8** (for Internal/External Zones 1~8) or **0** (for Internal/External All Call).
3. Announce the zone.
4. When a co-worker answers your page, press **Conf** softkey twice.

- OR -

Press the **Add** softkey followed by the **Begin** softkey.

5. Repeat steps 1~4 for each co-worker you want to add.

##### Single Line Telephone

1. While on a call, hookflash and dial **#1**.
2. Dial **703** and the External Paging zone code (**1~8** or **0** for All Call).

- OR -

Dial **\*1** and the Combined Paging Zone code **1~8** (for Internal/External Zones 1~8) or **0** (for Internal/External All Call).

3. Announce the zone.
4. When a co-worker answers your page, press hookflash twice.
5. Repeat steps 1~4 for each co-worker you want to add.

#### To join a Meet Me External Conference:

1. At the multiline terminal, press **Speaker**.  
- OR -  
At a single line telephone, lift the handset.
2. Dial **765**.
3. Dial the announced External Paging Zone code (**0~8**).  
◇ *You connect to the other parties.*

#### Meet Me Internal Conference

#### To make a Meet Me Conference via Internal Page:

##### Multiline Terminal

1. While on a call, press **Conf** softkey.
2. Dial **\*1** and the Combined Paging Zone code **1~8** (for Internal/External Zones 1~8) or 0 (for Internal/External All Call).
3. Announce the zone.
4. When a co-worker answers your page, press **Add**, Begin softkey.
5. Repeat steps 1~4 for each co-worker you want to add.

##### Single Line Telephone

1. While on a call, hookflash and dial **#1**.
2. Dial **\*1** and the Combined Paging Zone code **1~8** (for Internal/External Zones 1~8) or 0 (for Internal/External All Call).
3. Announce the zone.
4. When a co-worker answers your page, press hookflash twice.
5. Repeat steps 1~4 for each co-worker you want to add.

#### To join a Meet Me Internal Conference:

1. At the multiline terminal, press **Speaker** (or lift the handset).  
- OR -  
At the single line telephone, lift the handset.

2. Dial **763** (if your extension is in the zone called).

- OR -

Dial **764** and the zone number (if your extension is not in the zone called).

- OR -

Press the Meet Me Paging Pickup key (Program 15-07 or 23) if your extension is in the zone called.

## Meet Me Paging

### Description

Meet Me Paging allows an extension user to Page a co-worker and privately meet with them on a Page zone. The Paging zone is busy to other users while the meeting takes place. While the co-workers meet on the zone, no one else can hear the conversation, join in or make an announcement using that zone. Meet Me Paging is a good way to talk to a co-worker when their location is unknown. If the co-worker can hear the Page, they can join in the conversation.

### Conditions

- With Meet Me Paging Transfer, a user can page a co-worker and have the call automatically transfer when the co-worker answers the page.
- An extension access to internal and external page zones affects the Meet Me Paging feature.
- Internal and External Paging keys simplify Meet Me Paging operation.

### Default Settings

Enabled

### System Availability

#### Terminals

All Multiline Terminals

#### Required Component(s)

External zone paging requires a PGD(2)-U10 ADP installed in the system.

## Related Features

- ➔ [Meet Me Conference](#)
- ➔ [Meet Me Paging Transfer](#)
- ➔ [Paging, External](#)
- ➔ [Paging, Internal](#)
- ➔ [Programmable Function Keys](#)

## Guide to Feature Programming

The **Level 1**, **Level 2** and **Level 3** columns indicate the programs that are assigned when programming this feature in the order they are most commonly used. These levels are used with PCPro and WebPro wizards for feature programming.

- Level 1 – these are the most commonly assigned programs for this feature.
- Level 2 – these are the next most commonly assigned programs for this feature.
- Level 3 – these programs are not often assigned and require an expert level working knowledge of the system to be properly assigned.

◇ For additional programming information on Paging, refer to the features [Paging, External on page 2-1257](#) and [Paging, Internal on page 2-1267](#).

Program Number	Program Name/Description	Input Data	Default	Level		
				1	2	3
11-12-21	<b>Service Code Setup (for Service Access) – Meet-Me Answer to Specified Internal Paging Group</b> Customize the Service Codes used for meet-me answer to specified internal paging group service access.	MLT, SLT 0 ~ 9, *, # Maximum of eight digits	764		✓	
11-12-22	<b>Service Code Setup (for Service Access) – Meet-Me Answer to External Paging</b> Customize the Service Codes used for meet-me answer to external paging service access.	MLT, SLT 0 ~ 9, *, # Maximum of eight digits	765		✓	
11-12-23	<b>Service Code Setup (for Service Access) – Meet-Me Answer in Same Paging Group</b> Customize the Service Codes used for meet-me answer in same paging group service access.	MLT, SLT 0 ~ 9, *, # Maximum of eight digits	763		✓	
15-07-01	<b>Programmable Function Keys</b> Assign function keys for External Zone Paging (code 19 + zone), External All Call Paging (code 20), Internal Zone Paging (code 21 + zone) or Meet Me Conference/Paging Pickup (code 23).	Line Key 1 ~ 48 0 ~ 99 (Normal Function Code 751 by default) *00 ~ *99 (Appearance Function Code) (Service Code 752 by default)	Refer to the Programming Manual for default values.	✓		

Program Number	Program Name/Description	Input Data	Default	Level		
				1	2	3
20-06-01	<b>Class of Service for Extensions</b> Assign a Class of Service (1 ~ 15) to an extension.	Day Night/Mode: 1 ~ 8 Class of Service of Extensions (1 ~ 15)	Extension port 101 = Class 15 All other extension port = Class 1		✓	
20-10-06	<b>Class of Service Options (Answer Service) – Meet-Me Conference and Paging</b> Turn Off or On an extension user ability to use Meet-Me Conference and Paging.	0 = Off 1 = On	COS 1 ~ 15 = 1		✓	
31-02-01	<b>Internal Paging Group Assignment – Internal Paging Group Number</b> Assign extensions to Internal Paging Groups (i.e., Page Zones).	0 ~ 64 (0 = No Setting)	0 for IP Station 1 for TDM Station		✓	
31-02-02	<b>Internal Paging Group Assignment – Internal All Call Paging Receiving</b> Allow/Deny All Call Internal Paging for each extension. If allowed, extension can place and receive All Call Internal Paging announcements. If denied, extensions can make, but not receive, All Call Internal Paging announcements. If combined, Paging zones should be restricted as well, change the internal page zone group in Program 31-07-01 to 0.	0 = Deny 1 = Allow	0		✓	

## Operation

### Meet Me External Page

**To make a Meet Me External Page:**

1. At multiline terminal, press **Speaker** or pick up the handset.  
 - OR -  
 At the single line telephone, lift the handset.
2. Dial **703** and the External Paging Zone code (1~8 or 0 for All Call).  
 - OR -  
 Dial **\*1** and the Combined Paging Zone code 1~8 (for Internal/External Zones 1~8) or 0 (for Internal/External All Call).



3. Announce the zone.  
- OR -
1. At the multiline terminal, press the **External Paging Zone** key (Program 15-07 or SC 751: 19 + zone).
2. Announce the zone.

**To join a Meet Me External Page:**

1. At the multiline terminal, press **Speaker** or pick up the handset.  
- OR -  
At the single line telephone, lift the handset.
2. Dial **765**.
3. Dial the announced External Paging Zone (0~8).  
◇ *You connect to the other party.*

**Meet Me Internal Page****To make a Meet Me Internal Page:**

1. At the multiline terminal, press **Speaker** or pick up the handset.  
- OR -  
At the single line telephone, lift the handset.
2. Dial **701** and dial the Internal Paging Zone code (0~9, 00~32 or 00~64).  
- OR -  
Dial **\*1** and the Combined Paging Zone code 1~8 (for Internal/External Zones 1~8) or 0 (for Internal/External All Call).
3. Announce the zone.  
- OR -
1. At the multiline terminal, press the **Internal Paging Zone** key (Program 15-07 or SC 751: 21 + zone).
2. Announce the zone.

**To join a Meet Me Internal Page:**

1. At the multiline terminal, press **Speaker** or pick up the handset.  
- OR -  
At the single line telephone, lift the handset.

2. Dial **763** (if your extension is in the zone called).

- OR -

Dial **764** and the zone number (if your extension is not in the zone called).

- OR -

Press the Meet Me Conference/Paging Pickup key (Program 15-07 or SC 751: 23) if your extension is in the zone called.

## Meet Me Paging Transfer

### Description

If a user wants to Transfer a call to a co-worker but they do not know where the co-worker is, they can use Meet Me Paging Transfer. With Meet Me Paging Transfer, the user can Page the co-worker and have the call automatically Transfer when the co-worker answers the Page. Since Meet Me Paging Transfer works with both Internal and External Paging, a call can be quickly extended to a co-worker anywhere in the facility.

### Conditions

- An extension user can set up a conference with their current call and up to 31 other inside parties.
- An extension user can Page a co-worker and meet with them on a page zone.
- With External Paging, an extension user can broadcast an announcement over paging equipment connected to external paging zones.
- Internal Paging lets extension users broadcast announcements to other multiline terminals.
- Function keys simplify Meet Me Paging Transfer operation.

### Default Setting

Enabled

### System Availability

#### Terminals

All Multiline Terminals

#### Required Component(s)

External zone paging requires a PGD(2)-U10 ADP installed in the system.

### Related Features

- ↳ [Meet Me Conference](#)
- ↳ [Meet Me Paging](#)
- ↳ [Paging, External](#)

- ➔ **Paging, Internal**
- ➔ **Programmable Function Keys**

## Guide to Feature Programming

The **Level 1**, **Level 2** and **Level 3** columns indicate the programs that are assigned when programming this feature in the order they are most commonly used. These levels are used with PCPro and WebPro wizards for feature programming.

- Level 1 – these are the most commonly assigned programs for this feature.
  - Level 2 – these are the next most commonly assigned programs for this feature.
  - Level 3 – these programs are not often assigned and require an expert level working knowledge of the system to be properly assigned.
- ◇ For additional programming information on Paging, refer to the features [Paging, External on page 2-1257](#) and [Paging, Internal on page 2-1267](#).

Program Number	Program Name/Description	Input Data	Default	Level		
				1	2	3
10-21-04	<b>GCD-CP10 Hardware Setup – External Source I/O Selection on GCD-CP10</b> Define how the I/O ports on the GCD-CP10 are used.	0 = External MOH (AUX2)/ External Speaker(AUX1) 1 = BGM source (AUX2)/ External Speaker(AUX1) 2 = External MOH (AUX2)/ BGM source (AUX1) ➤ Relationships between AUX number and Relay number are as follows: AUX2 = Relay2 AUX1 = Relay1	1		✓	
11-12-21	<b>Service Code Setup (for Service Access) – Meet-Me Answer to Specified Internal Paging Group</b> Customize the Service Codes used for meet-me answer to specified internal paging group service access.	MLT, SLT 0 ~ 9, *, # Maximum of eight digits	764		✓	
11-12-22	<b>Service Code Setup (for Service Access) – Meet-Me Answer to External Paging</b> Customize the Service Codes used for meet-me answer to external paging service access.	MLT, SLT 0 ~ 9, *, # Maximum of eight digits	765		✓	
11-12-23	<b>Service Code Setup (for Service Access) – Meet-Me Answer in Same Paging Group</b> Customize the Service Codes used for meet-me answer in same paging group service access.	MLT, SLT 0 ~ 9, *, # Maximum of eight digits	763		✓	

Program Number	Program Name/Description	Input Data	Default	Level		
				1	2	3
15-07-01	<b>Programmable Function Keys</b> Assign function keys for External Zone Paging (code 19 + zone), External All Call Paging (code 20), Internal Zone Paging (code 21 + zone) or Meet Me Conference/Paging Pickup (code 23).	Line Key 1 ~ 48 0 ~ 99 (Normal Function Code 751 by default) *00 ~ *99 (Appearance Function Code) (Service Code 752 by default)	Refer to the Programming Manual for default values.	✓		
20-06-01	<b>Class of Service for Extensions</b> Assign a Class of Service (1 ~ 15) to an extension.	Day Night/Mode: 1 ~ 8 Class of Service of Extensions (1 ~ 15)	Extension port 101 = Class 15 All other extension port = Class 1		✓	
20-10-06	<b>Class of Service Options (Answer Service) – Meet-Me Conference and Paging</b> Turn Off or On an extension user ability to use Meet-Me Conference and Paging.	0 = Off 1 = On	COS 1 ~15 = 1		✓	
31-02-01	<b>Internal Paging Group Assignment – Internal Paging Group Number</b> Assign extensions to Internal Paging Groups (i.e., Page Zones).	0 ~ 64 (0 = No Setting)	0 for IP Station 1 for TDM Station		✓	
31-02-02	<b>Internal Paging Group Assignment – Internal All Call Paging Receiving</b> Allow/Prevent All Call Internal Paging for each extension. If allowed, extension can place and receive All Call Internal Paging announcements. If prevented, extensions can make (not receive) only All Call Internal Paging announcements. If combined, Paging zones should be restricted as well, change the internal page zone group in Program 31-07-01 to 0.	0 = Prevent 1 = Allow	0		✓	
31-03-01	<b>Internal Paging Group Settings – Internal Paging Group Name</b> Assign name to Internal Paging Groups (i.e., Page Zones). The system shows the name you program on the telephone display.	Maximum of 12 characters.	Refer to the Programming Manual for default values.		✓	

## Operation

### Meet Me External Paging Transfer

#### To make a Meet Me External Paging Transfer:

1. At the multiline terminal, while on a call, press **Hold**.

- OR -

At the single line telephone, while on a call, hookflash.

2. Press the **External Paging Zone** key (Program 15-07 or SC 751: 19 + zone or 20 for all external zones).

- OR -

Dial **703** and the External Paging Zone code (1~8 or 0 for All Call).

- OR -

Dial **\*1** and the Combined Paging Zone code 1~8 (for Internal/External Zones 1~8) or 0 (for Internal/External All Call).

3. Announce the call.
4. From a multiline terminal, when the paged party answers, press **Transfer** or the **Transfer** softkey.

- OR -

From a single line telephone, when the paged party answers, hang up.

◇ *The party is transferred.*

#### To join a Meet Me External Paging Transfer:

1. At the multiline terminal, press **Speaker** or pick up handset.

- OR -

At single line telephone, lift the handset.

2. Dial **765**.
3. Dial the announced External Paging Zone (0~8).

◇ *The Paging party is connected.*

4. Stay on the line.  
From a multiline terminal, press **Transfer** or the **Transfer** softkey.

- OR -

From a single line telephone, hang up.

◇ *The party is transferred.*

#### Meet Me Internal Paging Transfer

##### To make a Meet Me Internal Paging Transfer:

1. At multiline terminal, while on a call, press **Hold**.

- OR -

At the single line telephone, while on a call, hookflash.

2. Press **Internal Paging Zone** key (Program 15-07 or SC 751: 21 + zone or 22 for all internal zones).  
- OR -  
Dial **701** and the Internal Paging Zone code (0~9 or 00~64).  
- OR -  
Dial **\*1** and the Combined Paging Zone code 1~8 (for Internal/External Zones 1~8) or 0 (for Internal/External All Call).
3. Announce the call.
4. From a multiline terminal, when the paged party answers, press **Transfer** or the **Transfer** softkey.  
- OR -  
From a single line telephone, when the paged party answers, hang up.  
◇ *The party is transferred.*

#### **To join a Meet Me Internal Paging Transfer:**

1. At the multiline terminal, press **Speaker** or pick up handset.  
- OR -  
At the single line telephone, lift the handset.
2. Dial **763** (if your extension is in the zone called).  
- OR -  
Dial **764** and the zone number (if your extension is not in the zone called).  
- OR -  
Press the Meet Me Conference/Paging Pickup key (Program 15-07 or SC 751: 23) if your extension is in the zone called.
3. Stay on the line.  
From a multiline terminal, when the paged party answers, press **Transfer** or the **Transfer** softkey.  
- OR -  
From a single line telephone, when the paged party answers, hang up.  
◇ *The party is transferred.*

## Memo Dial

### Description

On an outside call, Memo Dial lets a multiline terminal user store an important number for easy redialing later on. The telephone can be like a notepad. For example, a user could dial Directory Assistance and ask for a client's telephone number. When Directory Assistance plays back the requested number, the caller can use Memo Dial to jot the number down in the telephone memory. They can quickly call the Memo Dial number after hanging up.

When a user enters a Memo Dial number, the dialed digits do not output over the trunk. Dialing Memo Dial digits does not interfere with a call in progress.

### Conditions

- When Memo Dial calls out, it outdials the entire stored number. Memo Dial does not automatically strip out trunk or PBX access codes if entered as part of the stored number.
- Only one number can be stored at a time.
- If a number is already stored in Memo Dial and you are on an internal or external call and the Dial Memo Key is pressed, the number is erased.
- A user's outgoing dialing options affect how a Memo Dial call is placed.
- Memo Dial is not available on single line telephones.

### Default Settings

Disabled

### System Availability

#### Terminals

All Multiline Terminals

#### Required Component(s)

None



## Related Features

- ➔ [Central Office Calls, Placing](#)
- ➔ [Last Number Redial](#)
- ➔ [Save Number Dialed](#)

## Guide to Feature Programming

The **Level 1**, **Level 2** and **Level 3** columns indicate the programs that are assigned when programming this feature in the order they are most commonly used. These levels are used with PCPro and WebPro wizards for feature programming.

- Level 1 – these are the most commonly assigned programs for this feature.
- Level 2 – these are the next most commonly assigned programs for this feature.
- Level 3 – these programs are not often assigned and require an expert level working knowledge of the system to be properly assigned.

Program Number	Program Name/Description	Input Data	Default	Level		
				1	2	3
15-07-01	<b>Programmable Function Keys</b> Assign a function key for Memo Dial (code 31).	Line Key 1 ~ 48 0 ~ 99 (Normal Function Code 751 by default) *00 ~ *99 (Appearance Function Code) (Service Code 752 by default)	Refer to the Programming Manual for default values.	✓		

## Operation

### To store a number while you are on a call:

1. While on a call, press **Memo Dial** key (Program 15-07 or SC 751: 31).
2. Dial number you want to store.
3. Press **Memo Dial** key again and continue with conversation.

### To call a stored Memo Dial number:

1. Do not lift the handset.
  2. Press the **Memo Dial** key (Program 15-07 or SC 751: 31).
  3. Press **Speaker**.
    - ◇ *The stored number dials out only if you store a trunk access code before the number.*
- OR -**
- Press the **line** key.
- ◇ *The stored number dials out.*

### To check to see the stored Memo Dial number:

1. Do not lift the handset.
2. Press **Memo Dial** key (Program 15-07 or SC 751: 31).
  - ◇ *The stored number displays.*

### To cancel (erase) a stored Memo Dial number:

1. Press **Speaker**.
2. Press the **Memo Dial** key (Program 15-07 or SC 751: 31).

## Message Waiting

### Description

An extension user can leave a Message Waiting indication at a busy or unanswered extension requesting a return call. The indication is a flashing MW lamp at the called extension and a steadily lit MW lamp on the calling extension. Answering the Message Waiting automatically calls the extension which left the indication. Message Waiting ensures that a user does not have to recall an unanswered extension. It also ensures that a user does not miss calls when their extension is busy or unattended.

Additionally, Message Waiting lets extension users:

- View and selectively answer messages left at their extension (display multiline terminal only)
- Cancel all messages left at their extension
- Cancel messages they left at other extensions

An extension user can leave Messages Waiting at any number of extensions. Also, any number of extensions can leave a Message Waiting at the same extension. A periodic VRS announcement may remind users that they have Messages Waiting.

### Message Key will Operate as Voice Mail Key

The system enhances a telephone Message key function when connected to a system which has voice mail installed. When an extension receives a voice mail, the Message key can be used to check the number of messages in voice mail, and call the voice mail to listen to the messages. If no Voice Mail Programmable Function Key is defined (Program 15-07-01, code 77), the telephone Message Waiting LED flashes to indicate new messages.

This option is not available with a networked voice mail – the voice mail must be local.

Refer to the [Voice Mail Integration \(Analog\) on page 2-1799](#) feature for the feature operation.

### LED Color Indication

The software allows you to select whether the Message Wait LED located at the top of the multiline terminal flashes green (0) or red (1) when a Message Wait indication is flashing. By default, this option is set to flash red.



NOTE

*If this LED is also used for voice mail indications (no Programmable Function Key programmed for voice mail), and there are both voice mail messages and Message Wait indications, the color set for Message Wait overrides the color used for voice mail indications (red).*

## Conditions

- Analog ports from APA or APR adapters do not provide Message Waiting lamping.
- When a user responds to a Message Waiting, the system does not cancel the Message Waiting indication if the called party uses Handsfree Answerback. The system cancels the indication only if the called party lifts the handset or presses Speaker.
- With the Hotel/Motel set up, an employee with a multiline terminal can send a Message Waiting to a room telephone if allowed in system programming.
- A Message Waiting key simplifies this feature operation.
- Telephone-to-telephone Message Waiting works when the voice mail is installed.
- The MW (Message Waiting) LED may be used to indicate voice mail messages if no extension number is assigned to the voice mail key in system programming.
- When using Message Waiting on line key (Program 15-07 or SC 751: 77 + mailbox number) with a UM8000, softkeys are not provided when logging into a UM8000 mailbox.
- If the following programs are changed while the phone is online, a reset of the feature is required before the setting takes effect.
  - ❑ Program 15-02-35 Message Waiting Lamp Cycle for Calling Extension
  - ❑ Program 15-02-36 Message Waiting Lamp Cycle for Called Extension
  - ❑ Program 15-02-37 Voice Mail Message Wait Lamp Color
  - ❑ Program 15-02-38 Voice Mail Message Wait Lamp Cycle
    - ◇ *For example, if a message waiting was set before any of these programs were changed, the lamp remains the same until the message waiting is set again.*
- If both Voice Mail Message and Message Wait indication are set, the color set for Message Wait overrides the color used for Voice Mail Message indication.
- When the system has the Hotel Motel license (0007), the Message Waiting Indication (MWI) on a DSS Console for an extension is a Green LED. Without the Hotel Motel license the MWI on a DSS Console for an extension is a Red LED.

## Default Settings

Enabled

## System Availability

### Terminals

All Terminals

## Required Component(s)

None

## Related Features

- ➔ [Handsfree Answerback/Forced Intercom Ringing](#)
- ➔ [Hotel/Motel](#)
- ➔ [Programmable Function Keys](#)
- ➔ [UM8000 Mail](#)
- ➔ [InMail](#)
- ➔ [Voice Response System \(VRS\)](#)

## Guide to Feature Programming

The **Level 1**, **Level 2** and **Level 3** columns indicate the programs that are assigned when programming this feature in the order they are most commonly used. These levels are used with PCPro and WebPro wizards for feature programming.

- Level 1 – these are the most commonly assigned programs for this feature.
- Level 2 – these are the next most commonly assigned programs for this feature.
- Level 3 – these programs are not often assigned and require an expert level working knowledge of the system to be properly assigned.

Program Number	Program Name/Description	Input Data	Default	Level		
				1	2	3
11-10-16	<b>Service Code Setup (for System Administrator) – Leaving Message Waiting (Requires CPU to be licensed for Hotel/Motel)</b> Customize the leave message waiting Service Codes (GCD-CP10 must be licensed for Hotel/Motel).	MLT 0 ~ 9, *, # Maximum of eight digits	626		✓	
11-11-09	<b>Service Code Setup (for Setup/Entry Operation) – Answer Message Waiting</b> Customize the answer message waiting service code.	MLT, SLT 0 ~ 9, *, # Maximum of eight digits	*0		✓	
11-11-10	<b>Service Code Setup (for Setup/Entry Operation) – Cancel All Messages Waiting</b> Customize the Cancel All Messages Waiting service code.	MLT, SLT 0 ~ 9, *, # Maximum of eight digits	773		✓	

Program Number	Program Name/Description	Input Data	Default	Level		
				1	2	3
11-11-11	<b>Service Code Setup (for Setup/Entry Operation) – Cancel Message Waiting</b> Cancel message waiting used for registration and setup.	MLT, SLT 0 ~ 9, *, # Maximum of eight digits	771		✓	
11-16-07	<b>Single Digit Service Code Setup – Message Waiting</b> Customize the message waiting Service Codes used to set message waiting when a busy or ring back signal is heard.	0 ~ 9, *, # Maximum of one digit	0		✓	
15-02-28	<b>Multiline Telephone Basic Data Setup – Message Waiting Lamp Color</b> Determine whether an extension Message Waiting Lamp lights Green or Red when a message is received.	0 = Green 1 = Red	1		✓	
15-02-35	<b>Multiline Telephone Basic Data Setup – Message Waiting Lamp Cycle for Calling Extension</b> Select the cycle that the Large LED flashes when the extension has set Message Waiting.	1 = Cycle 1 2 = Cycle 2 3 = Cycle 3 4 = Cycle 4 5 = Cycle 5 6 = Cycle 6 7 = Cycle 7	7		✓	
15-02-36	<b>Multiline Telephone Basic Data Setup – Message Waiting Lamp Cycle for Called Extension</b> Select the cycle that the Large LED flashes when the extension has Message Waiting set to the extension.	1 = Cycle 1 2 = Cycle 2 3 = Cycle 3 4 = Cycle 4 5 = Cycle 5 6 = Cycle 6 7 = Cycle 7	3		✓	
15-02-37	<b>Multiline Telephone Basic Data Setup – Voice Mail Message Wait Lamp Color</b> Select the Message Waiting flash pattern for the station that set the Message Waiting reminder.	0 = Green 1 = Red	1		✓	
15-02-38	<b>Multiline Telephone Basic Data Setup – Voice Mail Message Wait Lamp Cycle</b> Select the cycle method that the Large LED flashes when the extension has a VM Message Waiting set to the extension.	1 = Cycle 1 2 = Cycle 2 3 = Cycle 3 4 = Cycle 4 5 = Cycle 5 6 = Cycle 6 7 = Cycle 7	3		✓	
15-07-01	<b>Programmable Function Keys</b> Assign a function key for Message Waiting (code 38).	Line Key 1 ~ 48 0 ~ 99 (Normal Function Code 751 by default) *00 ~ *99 (Appearance Function Code) (Service Code 752 by default)	Refer to the Programming Manual for default values.	✓		

Program Number	Program Name/Description	Input Data	Default	Level		
				1	2	3
20-06-01	<b>Class of Service for Extensions</b> Assign a Class of Service (1 ~ 15) to an extension.	Day Night/Mode: 1 ~ 8 Class of Service of Extensions (1 ~ 15)	Extension port 101 = Class 15 All other extension port = Class 1		✓	
20-13-07	<b>Class of Service Options (Supplementary Service) – Message Waiting</b> Turn Off or On an extension user ability to leave Message Waiting.	0 = Off 1 = On	COS 1 ~ 15 = 1		✓	
80-01-01 (48)	<b>Service Tone Setup – Repeat Count</b> Set repeat count for tone 16 Lockout.		0 (endless). Refer to <a href="#">Table 2-33 Service Tone Setup Defaults, Program 80-01-01 on page 2-594</a>			✓
80-01-02 (48)	<b>Service Tone Setup – Basic Tone Number</b> Customize Service Tones.		0 Refer to <a href="#">Table 2-34 Service Tone Setup, Program 80-01-02 on page 2-598</a> .			✓

## Operation

### To leave a Message Waiting:

1. Call busy or unanswered extension.
2. Dial **0** or press the **Message Waiting** key (Program 15-07 or SC 751: 38).
3. Hang up.
  - ◇ *With multiline terminal telephones, the Message Waiting LED lights.*

### To answer a Message Waiting:



NOTE

*When you have a message, your Message Waiting LED flashes fast for multiline terminals.*

1. At the multiline terminal, press **Speaker** and dial **\*0**.
  - OR -
  - Press the **Message Waiting** key (Program 15-07 or SC 751: 38).
  - OR -

At the single line telephone, lift the handset and dial **\*0**.

- ◇ *If the called extension does not answer, dial 0 or press your **Message Waiting** key to automatically leave them a message.*
- ◇ *Normally, your Message Waiting LED goes out. If it continues to flash, you have new messages in your Voice Mail mailbox or a new General Message. See “To check your messages” below.*

### To cancel all your Messages Waiting:



NOTE

*This includes messages you have left for other extensions and messages other extension have left for you.*

1. At the multiline terminal, press **Speaker**.

- OR -

At the single line telephone, lift the handset.

2. Dial **773**.
3. Hang up.

### To cancel the Messages Waiting you have left at a specific extension:

1. At the multiline terminal, press **Speaker**.

- OR -

At the single line telephone, lift the handset.

2. Dial **771**.
3. Dial the number of the extension you do not want to have your messages.
4. Hang up.

### To check your messages:

1. Press **Message** key or the **MW** (Message Waiting) softkey.



2. Dial **\*0**.

You can have any combination of the message types in the table below on your telephone.

If you see. . .	You have. . .
<b>VOICE MESSAGE n MESSAGE</b>	New messages in your Voice Mail mailbox.
<b>CHECK MESSAGE VRS GENERAL MESSAGE</b>	A General message in Voice Mail that has not been heard.
<b>CHECK MESSAGE (name)</b>	Message Waiting requests left at your telephone by your co-workers.

3. Press VOL ▲ or VOL ▼ to scroll through your display.
4. When you find the message you want to answer, press **Speaker**. You can do one of the following:
  - Go to your Voice Mail mailbox.
  - Listen to the new General Message.
  - Automatically call the extension that left you a Message Waiting.

## Microphone Cutoff

### Description

Microphone Cutoff lets a multiline terminal user turn off their telephone handsfree or handset microphone anytime. When activated, Microphone Mute prevents the caller from hearing conversations in the user's work area. The user may turn off the microphone while their telephone is idle, busy on a call or ringing. The microphone stays off until the user turns it back on.

### Conditions

- Microphone Cutoff does not operate if the user calls another extension and the called extension user responds without lifting the handset or pressing Speaker.
- When using the Handset Transmission Cutoff key during an intercom call with the handset on-hook, you hear three beep tones and the LED is on solid. This also occurs on an outside call.
- When using the Handset Transmission Cutoff key during an intercom call with the handset off-hook, you hear three beep tones through the handset and the Handset Transmission Cutoff and MIC keys flash. This also occurs on an outside call.
- When Handset Transmission Cutoff is activated and the handset is off-hook, pressing Speaker and returning the handset to the cradle turns off the Handset Transmission Cutoff key. Three beep tones are heard over the telephone speaker.

### Default Setting

Enabled (using MIC key)

### System Availability

#### Terminals

All Multiline Terminals

#### Required Component(s)

None

## Related Features

- ➔ [Handset Mute](#)
- ➔ [Handsfree Answerback/Forced Intercom Ringing](#)
- ➔ [Programmable Function Keys](#)

## Guide to Feature Programming

The **Level 1**, **Level 2** and **Level 3** columns indicate the programs that are assigned when programming this feature in the order they are most commonly used. These levels are used with PCPro and WebPro wizards for feature programming.

- Level 1 – these are the most commonly assigned programs for this feature.
- Level 2 – these are the next most commonly assigned programs for this feature.
- Level 3 – these programs are not often assigned and require an expert level working knowledge of the system to be properly assigned.

Program Number	Program Name/Description	Input Data	Default	Level		
				1	2	3
15-07-01	<p><b>Programmable Function Keys</b></p> <p>If an extension needs handset microphone cutoff, program a Handset Transmission Cutoff key (code 40). To program a MIC Cutoff key, use code 02 as the entry. The MIC Cutoff key mutes conversation on a handsfree call, but the Handset Transmission Cutoff key mutes the handset transmission on a non-handsfree call.</p>	<p>Line Key 1 ~ 48</p> <p>0 ~ 99 (Normal Function Code 751 by default)</p> <p>*00 ~ *99 (Appearance Function Code) (Service Code 752 by default)</p>	Refer to the Programming Manual for default values.	✓		
20-02-11	<p><b>System Options for Multiline Telephones – Handsfree Microphone Control</b></p> <p>Control the setting for multiline terminal handsfree microphone after being disconnected and reconnected. If set to 0, the microphone is always off when the terminal is reconnected. If set to 1, the microphone remains in the same state it was in when the terminal is reconnected.</p>	<p>0 = Off</p> <p>1 = On</p>	1		✓	

## Operation

### To mute your telephone handset or Handsfree microphone while on a call:

1. Press **MIC**.
    - ◇ *This only turns off the Handsfree microphone.*
- OR -
- Press the **Microphone Cutoff** key (Program 15-07 or SC 751: 40).
- ◇ *This turns off both the handset and Handsfree microphone.*

### To turn your telephone microphone back on:

1. Press **MIC**.
    - ◇ *Use **MIC** only if you pressed it initially to turn off your Handsfree microphone.*
- OR -
- Press the **Microphone Cutoff** key (Program 15-07 or SC 751: 40).
- ◇ *Use the **Microphone Cutoff** key only if you pressed it initially to turn off your handset or Handsfree microphone.*

## Migration – SV8100/SV8300

### Description

The Migration – SV8100/SV8300 feature allows a UNIVERGE SV8100 database to be converted to a SV9100 database to utilize the enhanced capabilities of the SV9100.



*Older telephones on new systems may be compatible but will have certain limitations depending on installation and feature usage. Such limitations cannot be listed due to site specific usage. NEC always recommends migrating to the telephones advertised as compatible for specific systems.*

### Conditions

- The Migration – SV8100/SV8300 feature is available with **Version 1000 or higher**.
- Refer to the SV9100 System Hardware Manual for a complete list of supported packages.
- Hardware Migration license (0048) is required to migrate SV8100 hardware to the SV9100.
- The Hardware Migration license (0048) is not required if the SV8100 daughter board is installed on SV9100 main board. For example, a GCD-8DLCA with PZ-8DLCB would not require the Hardware Migration License.
- SV8100 licenses will not migrate.
- After an SV8100 to SV9100 database conversion there will be no VoIP Daughter Board and GCD-CP10 present.
- SV9100 does not support the IPK Migration board.
- InMail messages and recordings will not migrate.
- SV8100 UC Desktop Suite and Softphone will not migrate.
- Unified Communications for Business (UCB) will not migrate.
- When migrating from SV8100 to SV9100, the InMail auto programs to use Department Group 64. For example, if Department Group 64 was previously being used on the SV8100 for UM8000, the UM8000 will need to be re-programmed to use a different Department Group.

### Supported Hardware

Table 2-82 SV8100 Supported Hardware

Package	Description	Supported
CHS2U	19" Chassis	Yes
CHS2U B	9.5" Chassis	Yes
CHS2U E	9.5" Expansion Chassis	Yes

Table 2-82 SV8100 Supported Hardware (Continued)

Package	Description	Supported
PZ-xxIPLA	Voice Over IP Daughter Board	No
PZ-xxIPLB	Voice Over IP Daughter Board	No
PZ-BS10	Expansion Board for Controlling Chassis	Yes
PX-BS11	Expansion Board for Expansion Chassis	Yes
CD-8DLCA	8 Digital Station Interface	Yes
PZ-8DLCA	8 Digital Station Interface Daughter Board	Yes
CD-16DLCA	16 Digital Station Interface	Yes
CD-16LCAH	Analog Terminal Blade	Yes
CD-4LCA	4 Single Line Telephone Interface	Yes
PZ-4LCA	4 Single Line Telephone Interface Daughter Board	Yes
CD-8LCA	8 Single Line Telephone Interface	Yes
PZ-8LCE	8 Single Line Telephone Interface Daughter Board	Yes
CD-LTA	Combo Card 8 Digital, 2 Single Line, and an optional PZ-4COTF or PZ-2BRIA can be Installed	Yes
CD-4COTB	4 Loop/Ground Start Trunk	Yes
PZ-4COTF	4 Loop/Ground Start Trunk Daughter Board	Yes
CD-8COTBH	8 Loop/Ground Start	Yes
CD-2BRIA	2 Basic Rate Interface	Yes
PZ-2BRIA	2 Basic Rate Interface Daughter Board	Yes
CD-PRTA	1 Primary Rate Interface	Yes
CD-CCTA	CCIS Trunk Interface/Common Channel Handler	Yes
CD-4ODTA	4 E&M	Yes
CD-RTB	Router	Yes
CD-VM00	Voice Mail and Server	Yes
CD-4DIOPA	4 DID/OPX	Yes
CD-ETIA	Switching Hub with Power over Ethernet	Yes
GCD-SVR2	Server Blade (Desktop Suite and ACD MIS)	**Yes
GCD-SVR2	Server Blade (NEC Meeting Center (NMC))	Yes
GCD-SVR2	Server Blade	***Yes
CD-PVAA (CCIS) US Only	CCIS Point-to-Multipoint	Yes

Table 2-82 SV8100 Supported Hardware (Continued)

Package	Description	Supported
CD-PVAA PVA (PMS)	Property Management System	Yes
CD-PVAA (IVR) US Only	Interactive Voice Response	No
CD-PVAA (CNF) US Only	Multimedia Conference	No
CD-RGA	Gateway Application	*Yes

\* - Requires firmware upgrade to migrate to the SV9100.

\*\* - Requires SV9100 InServer Migration kit.

\*\*\* - Requires SVR2 Migration kit.

### Supported Terminals

Table 2-83 SV8100 Supported Terminals

Terminal	Supported
Dterm80/85 (DTH & DTR)	No
DT300 Series (DTL)	Yes
DT400 Series (DTL)	Yes
DT700 Series (ITL)	Yes
DT800 Series (ITL)	Yes
MH240	No
ML440	Yes
Bluetooth Cordless Handset (BCH)	Yes
SLT	Yes
SIP Terminal	Yes
IP-DECT	Yes
Softphone	No
DTL-8R-1 Cordless terminal	Yes
DTZ-8R-1 Cordless terminal	Yes

 Cordless terminals (DTH-4R-1/DTR-1R-2) are not supported.

### Conversion Exception

Table 2-84 SV8100 Conversion Exception

SV8100 Program Number	SV9100 Program Number	Comments
10-03 (VoIP) 10-40	10-68 14-18	The conversion of data for VOIP does not support conversion. The VOIP package of SV8100 is deleted after conversion completion. Please set VOIP package with blade configuration. Thereafter IP trunks are set in Program 10-68.

Table 2-84 SV8100 Conversion Exception (Continued)

SV8100 Program Number	SV9100 Program Number	Comments
10-26-01	15-05-50	The conversion of IP system communication mode, the peer to peer mode does not support conversion. It is changed to the extension terminal-based setting. After conversion completion, Please set Program 15-05-50.
10-26-03	15-05-50	The conversion of IP system communication mode, the peer to peer mode does not support conversion. It is changed to the extension terminal-based setting. After conversion completion, Please set Program 1 5-05-50.
10-29-08 10-29-09 10-29-10	10-67-01 10-67-02 10-67-03	The conversion of SIP server information, DNS server setting does not support conversion. Please set Programs 10-67-01, 10-67-02 and 10-67- 03.
84-32-01 ~ 84-32-07	84-33-12 ~ 84-33-18	The conversion of Fax over IP Codec information does not support conversion. Please set Program 84- 33 for every type.
84-01-69 ~ 84-01-71	84-35-01 ~ 84-35-03	The conversion of RFC2833 play out level setting does not support conversion. Please set Program 84- 35 for every type.
84-12-39 ~ 84-12-41	84-35-01 ~ 84-35-03	The conversion of H.323 Codec setting does not support conversion. Please set Program 84-35 for every type.
84-13-62 ~ 84-13-64	84-35-01 ~ 84-35-03	The conversion of SIP trunk Codec setting does not support conversion. Please set Program 84-35 for every type.
84-19-62 ~ 84-19-64	84-35-01 ~ 84-35-03	The conversion of SIP extension Codec setting does not support conversion. Please set Program 84- 35 for every type.
84-21-44 ~ 84-21-46	84-35-01 ~ 84-35-03	The conversion of CCIS trunk Codec setting does not support conversion. Please set Program 84-35 for every type.
84-25-50 ~ 84-25-52	84-35-01 ~ 84-35-03	The conversion of NetLink Codec setting does not support conversion. Please set Program 84-35 for every type.
84-31-19 ~ 84-31-25	84-36 and 84-38	The conversion of VOIP echo canceler setting does not support conversion. Please set Program 84- 36 and 84-38.
84-31-26 ~ 84-31-36	84-38	The conversion of VOIP echo canceler setting does not support conversion. Please set Program 84- 38 for every type.
84-26	84-26	The VOIP package does not support conversion because it is deleted after the conversion process. Please set Program 84-26-01~84-26-03.
15-01-01 (InMail)	15-01-01 (Port 897~912)	The extension name of InMail does not support conversion.



**Program Data Moved**

*Table 2-85 Program Data Moved*

SV8100 Setting	SV9100 Setting
84-31-36	84-33-06
84-01-44	84-33-08
84-01-45	84-33-09
84-01-46	84-33-10
84-01-55	84-33-11
84-01-59	84-33-01
84-01-62	84-34-01
84-12-31	84-34-01
84-12-32	84-33-01
84-13-30	84-34-02
84-13-31	84-34-01
84-13-50	84-33-01
84-13-51	84-33-02
84-13-52	84-33-06
84-13-56	84-33-08
84-13-57	84-33-09
84-13-58	84-33-10
84-13-61	84-33-05
84-19-31	84-34-02
84-19-32	84-34-01
84-19-50	84-33-01
84-19-51	84-33-02
84-15-52	84-33-06
84-19-56	84-33-08
84-19-57	84-33-09
84-19-58	84-33-10
84-19-61	84-33-05
84-21-21	84-34-01
84-21-42	84-33-01
84-25-31	84-34-01
84-25-32	84-33-01
84-27-08	84-35-04
84-27-09	84-35-05
84-27-10	84-37-02

Table 2-85 Program Data Moved (Continued)

SV8100 Setting	SV9100 Setting
84-27-11	84-37-03
84-27-12	84-36-02
84-27-13	84-36-01
84-27-15	84-37-04
84-27-16	84-37-01
84-27-17	84-37-05
10-36	10-36
10-28-04	10-36-02
10-30-02	10-36-03
10-30-03	10-36-04
10-30-04	10-29-20
10-12-06	10-29-21

### Input Value Change

Table 2-86 Input Value Change

SV8100 Program Number	SV8100 Program Setting	SV9100 Program Setting
10-12-11	0:Auto Detect 1:100Mbps, Full Duplex 2:100Mbps, Half Duplex 3:10Mbps, Full Duplex 4:10Mbps, Half Duplex 5:1Gbps, Full Duplex 6:1Gbps, Half Duplex	0:Auto Detect 1:100Mbps, Full Duplex 3:10Mbps, Full Duplex 5:1Gbps, Full Duplex
84-01-15 84-11-17 84-12-17 84-13-17 84-19-17 84-21-22 84-24-17 84-25-17	1:Static 2:Adaptive during silence 3:Adaptive immediately	1:Static 3:Self adjusting
84-31-08	0:Disable 1:Line E.C. 2:Acou.E.C.	1:Line E.C. 2:Acou.E.C.
184-31-02 84-31-37	0:disable 1:Enable 2:Echo Path Mode 3:Echo Path Auto Detect Mode	0:Disable 1:Enable

Table 2-86 Input Value Change (Continued)

SV8100 Program Number	SV8100 Program Setting	SV9100 Program Setting
84-21-19 84-21-20	0:G.711_PT 1:G.723_PT 2:G.729_PT 3:G.722_PT 4:G.726_PT 5:iLBC	0:G.711_PT 2:G.729_PT 3:G.722_PT 4:G.726_PT
84-11-28	0:G.711_PT 1:G.723_PT 2:G.729_PT	0:G.711_PT 2:G.729_PT
84-19-28 84-13-28	0:G.711_PT 1:G.723_PT 2:G.729_PT 3:G.722_PT 4:G.726_PT 5:iLBC	0:G.711_PT 2:G.729_PT 3:G.722_PT 4:G.726_PT
84-01-22	0:Adaptec - 1:-19db(-49dbm) 20:0db (-30dbm) 30:10db (-20dbm)	20:(-30dbm) 1:-19db(-49dbm) 20:0db (-30dbm) 30:10db (-20dbm)
84-11-18 84-12-18 84-13-18 84-19-18 84-21-23 84-24-18 84-25-18	0:Adaptec - 1:-19db(-49dbm) 20:0db (-30dbm) 30:10db (-20dbm)	20:(-30dbm) 1:-19db(-49dbm) 20:0db (-30dbm) 30:10db (-20dbm)
10-03-03 10-03-04 14-01-02 14-01-03 14-01-04 14-01-05 15-02-29 31-06-04 31-06-05 32-03-02 32-03-03 44-07-01 44-07-02 44-07-03 44-07-04 47-01-18 47-01-19 47-10-02 80-01-04	1:-15.5db ~ 57:12.5db 58:13.0db 59:13.5db 60:14.0db 61:14.5db 62:15.0db 63:15.5db	1:-15.5db ~ 57:12.5db

Table 2-86 Input Value Change (Continued)

SV8100 Program Number	SV8100 Program Setting	SV9100 Program Setting
15-05-18	0:Disable 1:Group1 2:Group2 3:Group3 4:Group4 5:Group5 6:Group6 7:Group7 8:Group8 9:Group9 10:Group10	0:Disable 1:Enable
35-01-01	0:Not set 3:LAN 4:CTA/CTU	0:Not set 3:LAN
42-05-01	0:Not set 1:CTA 3:LAN	0:Not set 3:LAN
90-12-01 90-13-01	0:Not set 4:CTA/CTU 5:USB	0:Not set 5:USB

## UX5000 Migration

### Conditions

- A UX5000 database cannot be converted directly to an SV9100 database. You must first convert the UX5000 database to an SV8100 database using SV8100 PcPro and save the database file as (\*.pcp). Next, convert the SV8100 database to SV9100 database using SV9100 PcPro.
- For detailed information converting a UX5000 database to an SV8100 database, please refer to the UNIVERGE SV8100 – UX5000 to SV8100 Migration Manual.
- UX5000 Licenses are not supported.
- With no migration license, DG/IP (UX5000) terminals are only supported on GCD blades. CD blades are supported only with the migration.
- The UX Mail is not supported.
- Refer to the UNIVERGE SV8100 – UX5000 to SV8100 Migration Manual for more information.
- When UX5000 terminals are installed in the SV9100, the keys on the phone are remapped (refer to [Table 2-87 UX5000 Keys](#)). Existing DESI labels need to be replaced with new DESI Labels showing the remapped keys (part numbers 0910750~0910753 and 0910755):

Table 2-87 UX5000 Keys

Original UX5000 Keys	Remapped UX5000 Keys
CALL 1	Answer
CALL 2	Feature
DND	Conf
DIAL	Directory
FLASH	Recall
MIC (LED On = MIC Muted)	Mic (LED On = MIC Enabled)
CONF	Transfer
SPK	Speaker
HOLD	Hold

Default Setting

Disabled

## System Availability

### Terminals

DT300/DT700

### Required Component(s)

- The GCD-CP10-US must be installed in the CHS2U-US (19") or CHS2U B-US (9.5") controlling chassis.
- SV8100 PcPro (if converting UX5000)
- SV9100 PcPro

## Related Features

➔ [PC Programming](#)

## Guide to Feature Programming

None

## Operation

Refer to the UNIVERGE SV9100 PC Programming Manual for more information.

Refer to the UNIVERGE SV8100 – UX5000 to SV8100 Migration Manual for more information.

## Migration – SV9100-S to SV9100-E System

### Description

The SV9100 system is available in two different system sizes and can be migrated from the SV9100-S system to the SV9100-E system. The SV9100-S system is limited to 48 ports and the SV9100-E system can have a maximum of 1296 ports.

### Conditions

- When migrating from the SV9100-S system to the SV9100-E system, the SV9100-S to -E Expansion Kit is required.
- The SV9100-S system requires the SD-A1 card.
- The SV9100-E system requires the SD-B1 card.
- During the migration, the 48 built-in Resource Licenses on the SV9100-S system are not carried over to the SV9100-E system.
- SV8100 Licenses do not migrate to the SV9100-S or SV9100-E system.
- The UM8000 Voice Mail is not supported in the SV9100-S system.
- The SV9100-S system is restricted to 48 resources maximum and by default has 48 SV9100 Resource licenses.
- NetLink requires the SD-B1 card.
- InMail does not use any of the 48 resources in a SV9100-S system.

### Default Settings

None

### System Availability

#### Terminals

N/A

#### Required Component(s)

Expansion Kit: (GPZ-IPLE, 4GB SD-B1, 8 Standard Licenses and 8 Resource Licenses).

## Related Features

None

## Guide to Feature Programming

None

## Operation

None



## Mobile Extension

### Description

A mobile extension is an external telephone (preferably a mobile phone) linked to the UNIVERGE SV9100 via a Proxy Port to operate as an internal single line telephone extension. The extension sends DTMF signals to the system allowing access to the system features. A registered Mobile Extension uses one analog port (ports are reserved in groups of two), however, **no** PCB support (analog or digital) is required. The Mobile Extension port must be an unequipped extension port on the UNIVERGE SV9100 system - no physical telephone is required on the SV9100 system.



*A mobile extension cannot be used as a voice mail port.*

Figure 2-64 Mobile Extension Layout

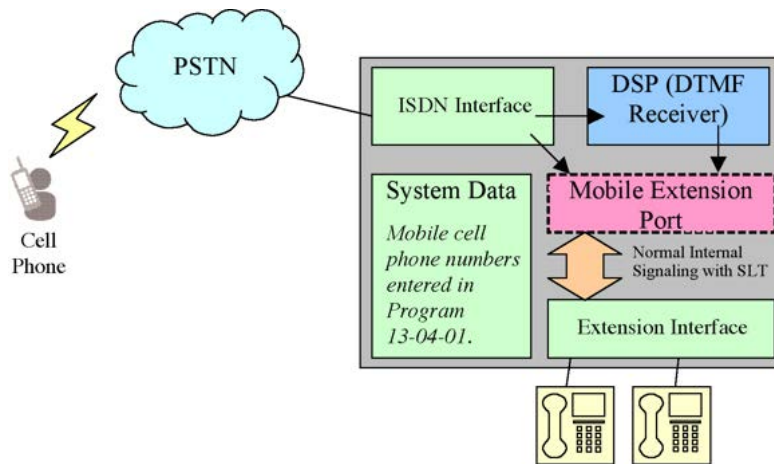

This feature can currently be used with ISDN PRI trunks or SIP trunks.



*Mobile Extension is not supported on analog trunks.*



*To provide a proper disconnect, Disconnect Supervision is required for the trunks used for this feature.*

The Mobile extension internal extension number (Proxy Port) is linked to a speed dial bin to provide integration.



*If all external trunks are busy when a call is made to the mobile extension, ringback tone is presented giving the impression the phone is ringing.*

A DID is directed to the Mobile Extension internal extension number (Proxy Port), and to provide internal dial tone to the Mobile Extension, the incoming calling line identification of the Mobile Extension must match the number in the Speed Dial bin. Once internal dial tone is presented, the operation is similar to a single line telephone user lifting the handset.

Any DID with Program 22-11-13 enabled, provides internal dial tone to the Mobile Extension, must have an incoming calling line identification that matches exactly the number of any Mobile Extension Speed Dial Bins.

In the absence of DIDs, the VRS can be used to transfer the Mobile Extension call to the Mobile Extension extension number. This provides internal dial tone when the calling line identification is presented and matches the number in the associated Speed Dial bin.

Alternatively, if calling line identification routing is enabled, the relevant Speed Dial bin could be transferred to the Mobile Extension proxy port, which would then provide internal dial tone.

The number of Mobile Extensions per system is limited by the available unequipped extension ports.

## Features

The features available from a Mobile Extension are listed below. As the Mobile Extension is based on a single line telephone port, the service codes used are as per a single line telephone port. Any feature not listed should be assumed to be not supported:

- Hold
- Transfer
- Incoming Ring Group member
- Department Group member
- DID
- Toll Restriction
- Class of Service
- DSS Keys

Though DSS keys are available for the Mobile Extension, they cannot provide an exact indication of busy status if, for example, the Mobile Extension is active on a call not linked to the UNIVERGE SV9100.

The following service codes are supported:

Table 2-88 Supported Service Codes

Type Incoming Feature	Program	Code	Set By Mobile Extension	Set to Mobile Extension
Night Mode Switching	11-10-01	718	<b>Yes</b>	
Night Mode Switching for Other Group	11-10-12	618	<b>Yes</b>	

Table 2-88 Supported Service Codes (Continued)

Type Incoming Feature	Program	Code	Set By Mobile Extension	Set to Mobile Extension
Call Forward – All	11-11-01	741	<b>Yes</b>	<b>Yes</b>
Call Forward – Busy	11-11-02	742	<b>Yes</b>	<b>Yes</b>
Call Forward – No Answer	11-11-03	743	<b>Yes</b>	<b>Yes</b>
Call Forward – Busy/No Answer	11-11-04	744	<b>Yes</b>	<b>Yes</b>
Call Forward – Both Ring	11-11-05	745	<b>Yes</b>	<b>Yes</b>
Call Forward – Follow-Me	11-11-07	746	<b>Yes</b>	<b>Yes</b>
Do Not Disturb	11-11-08	747	<b>Yes</b>	
Answer Message Waiting	11-11-09	*0	<b>Yes</b>	
Cancel All Messages Waiting	11-11-10	773	<b>Yes</b>	
Automatic Transfer Setup for Each Extension Group	11-11-25	602	<b>Yes</b>	
Automatic Transfer Cancellation for Each Extension Group	11-11-26	603	<b>Yes</b>	
Delayed Transfer for Every Extension Group	11-11-28	605	<b>Yes</b>	
Delayed Transfer Cancellation for Each Extension Group	11-11-29	606	<b>Yes</b>	
DND Setup for Each Extension Group	11-11-30	607	<b>Yes</b>	
DND Cancellation for Each Extension Group	11-11-31	608	<b>Yes</b>	
Pilot Group Withdrawing	11-11-35	650	<b>Yes</b>	
Station Speed Dial Number Entry	11-11-39	755	<b>Yes</b>	
Auto Attendant	11-11-44	No Setting	<b>Yes</b>	
Bypass Call	11-12-01	707	<b>Yes</b>	<b>Yes</b>
Conference	11-12-02	#1	<b>Yes</b>	
Override (Off-Hook Signaling)	11-12-03	709	<b>Yes</b>	
Set Camp-On	11-12-04	750	<b>Yes</b>	<b>Yes</b>
Cancel Camp-On	11-12-05	770	<b>Yes</b>	<b>Yes</b>
Switching of Voice Call and Signal Call	11-12-06	712	<b>Yes</b>	
Step Call	11-12-07	708	<b>Yes</b>	<b>Yes</b>
Barge-In	11-12-08	710	<b>Yes</b>	<b>Yes</b>
Change to STG (Department Group) All Ring	11-12-09	No Setting	<b>Yes</b>	
Station Speed Dialing	11-12-10	#2	<b>Yes</b>	
Group Speed Dialing	11-12-11	#4	<b>Yes</b>	
Trunk Group Access	11-12-14	704	<b>Yes</b>	

Table 2-88 Supported Service Codes (Continued)

Type Incoming Feature	Program	Code	Set By Mobile Extension	Set to Mobile Extension
Specified Trunk Access	11-12-15	#9	Yes	
Trunk Access Via Networking	11-12-16	No Setting	Yes	
Internal Group Paging (Mobile Extension cannot be a member of a paging group)	11-12-19	701	Yes	
External Paging	11-12-20	703	Yes	
Meet-Me Answer to Specified Internal Paging Group	11-12-21	764	Yes	
Meet-Me Answer to External Paging	11-12-22	765	Yes	
Meet-Me Answer in Same Paging Group (although Mobile Extension cannot be paged)	11-12-23	763	Yes	Yes
Combined Paging	11-12-24	*1	Yes	
Direct Call Pickup – Own Group	11-12-25	756	Yes	Yes
Call Pickup for Specified Group	11-12-26	768	Yes	Yes
Call Pickup	11-12-27	*#	Yes	Yes
Call Pickup for Another Group	11-12-28	769	Yes	Yes
Direct Extension Call Pickup	11-12-29	**	Yes	
Park Hold	11-12-31	#6	Yes	
Answer for Park Hold	11-12-32	*6	Yes	
Group Hold	11-12-33	732	Yes	
Answer for Group Hold	11-12-34	762	Yes	
Personal (Extension) Park	11-12-35	757	Yes	
Door Box Access (Door Box can also ring the Mobile Extension, *# operates relay)	11-12-36	702	Yes	
Common Canceling Service Code	11-12-37	620	Yes	
General Purpose Indication	11-12-38	783	Yes	
Station Speed Dialing	11-12-40	#7	Yes	
Voice Over	11-12-41	690	Yes	
Flash on Trunk lines	11-12-42	#3	Yes	
Enabled On Hook when Holding (SLT)	11-12-45	749	Yes	
Answer On Hook when Holding (SLT)	11-12-46	759	Yes	
Call Waiting Answer/Split Answer	11-12-47	794	Yes	
Account Code	11-12-48	##	Yes	

Table 2-88 Supported Service Codes (Continued)

Type Incoming Feature	Program	Code	Set By Mobile Extension	Set to Mobile Extension
General Purpose Relay	11-12-50	780	Yes	
VM Access (InMail and VMS)	11-12-51	*8	Yes	
Live Recording at SLT	11-12-53	654	Yes	
VRS Routing for ANI/DNIS	11-12-54	682	Yes	
Tandem Trunking	11-12-57	#8	Yes	
Transfer into Conference	11-12-58	624	Yes	
Set DND for Other Extension	11-14-03	629	Yes	Yes
Cancel DND for Other Extension	11-14-04	630	Yes	Yes
Set Wake Up Call for Own Extension	11-14-05	631	Yes	
Cancel Wake Up Call for Own Extension	11-14-06	632	Yes	
Set Wake Up Call for Other Extension	11-14-07	633	Yes	Yes
Cancel Wake Up Call for Other Extension	11-14-08	634	Yes	Yes
Set Room to Room Call Restriction	11-14-09	635	Yes	Yes
Cancel Room to Room Call Restriction (Hotel)	11-14-10	636	Yes	Yes
Change Toll Restriction Class for Other Extension	11-14-11	637	Yes	Yes
Check-in	11-14-12	638	Yes	Yes
Check-out	11-14-13	639	Yes	Yes
Room Status Change for Own Extension	11-14-14	640	Yes	
Room Status Change for Other Extension	11-14-15	641	Yes	Yes
Room Status Output	11-14-16	642	Yes	
Hotel Room Monitor	11-14-17	675	Yes	Yes

Although some features may be available to the Mobile Extension, it may be advisable to disable them in Class of Service. There are also features that should be disabled in any case.

The features **to be disabled/not used** for Mobile Extension include:

- Contact Center
- TAPI (including applications such as UC Desktop Suite, etc.)
- H.323 Trunks
- Analog Trunks
- Port Swap

- Hotline
- General Message
- Message Waiting
- Headset Mode for single line telephone
- Flexible Transfer/Virtual Loop Back
- Tandem Ringing
- Park over CCIS
- Virtual extension key as Call Coverage Key for mobile extension
- Automatic Conversation Record for trunks

#### Caller ID Presented to the Mobile Extension\* for Type of Call

- Direct Internal Call** – CPN of the Calling Phone is presented to the Mobile Extension.
  - Direct Trunk Call with CID** – Caller ID of incoming call is presented to the Mobile Extension\*\*.
  - Direct Trunk Call without CID** – CPN of Mobile Extension is presented to the Mobile Extension.
  - Transferred Trunk Call with CID** –
    - Transferred before inter-digit timeout – Caller ID of incoming call is presented to the Mobile Extension\*\*.
    - Transferred after inter-digit timeout – CPN of the Transferring Phone is presented to the Mobile Extension.
  - Transferred Trunk Call without CID** –
    - Transferred before inter-digit timeout – CPN of Mobile Extension is presented to the Mobile Extension.
    - Transferred after inter-digit timeout – CPN of the Transferring Phone's CPN is presented to the Mobile Extension.
- \* Only when the outbound trunks are ISDN or SIP trunks.
- \*\* ISDN will need to accept the inbound Caller ID as the Calling Party Number (CPN) presentation for the outbound call.

#### Conditions

- Mobile Extension is only supported with ISDN/SIP trunks, Analog trunks are not supported.
- If the extension has Call Forward-Both Ring set to a Mobile Extension (twinning), it can only forward to VM (NA or B/NA) and nowhere else.
- If an extension has Call Forward-Both Ring set to a Mobile Extension (twinning), it will not forward when the Mobile Extension is forwarded All or B/NA (Busy Immediate).
- ISDN and SIP trunks are supported for the outbound call to the Mobile Extension
- For the **extension** DTMF, the minimum Detect Level for the DTMF Tone (Program 80-03-03) must be set to allow a minimum detection level of -25dBm. This entry is dependent on the Detect Level selected in Program 80-03-01.

- The Mobile Extension uses the \* to perform a flash, so any service codes which begin with \* must be changed (Programs 11-10, 11-11, 11-12, 11-13).
- To provide a proper disconnect, Disconnect Supervision is required for the trunks used for this feature.
- When an entry is made in Program 15-22-01 for a Mobile Extension, ports are reserved for Mobile Extension usage in groups of 2.
- To keep consecutive port numbering for blades, you may wish to consider starting Mobile Extensions at the upper extension port range.
- When using Mobile Extension in a NetLink Network, the ISDN/PRI can be utilized in the Secondary systems.
- Calls on Mobile Extension can be easily picked up from a telephone in the SV9100 system. This is done via a Barge-In key (34+Mobile Ext# or 34+\*) \* will Barge in to the Extension that Call Forward Both Ring is set to. If no Forward Both Ring is set, the key will act as a basic Barge-In key.
- A Progress Tone is played to the caller until the call to the Mobile Extension number is set up.
- Program 15-22-02 must be set to (0 Confirmation is required on all lines) or (1 Confirmation is required on only analog lines) for the Mobile Extension port when utilizing Analog Trunks.

## Callback to Cell Phone

### Description

Callback to Cell Phone allows the user to make an incoming call to a system then hang up before the system answers (like a one ring call), then the system calls back to the calling Cell Phone using a pre-programmed number. The advantage is to reduce Cell Phone charges for calls on a mobile extension system.

After receiving a call back on a Cell Phone, the user can call another extension or make an outgoing call via the system using the mobile extension function.

Figure 2-65 Example – Callback to Cell Phone

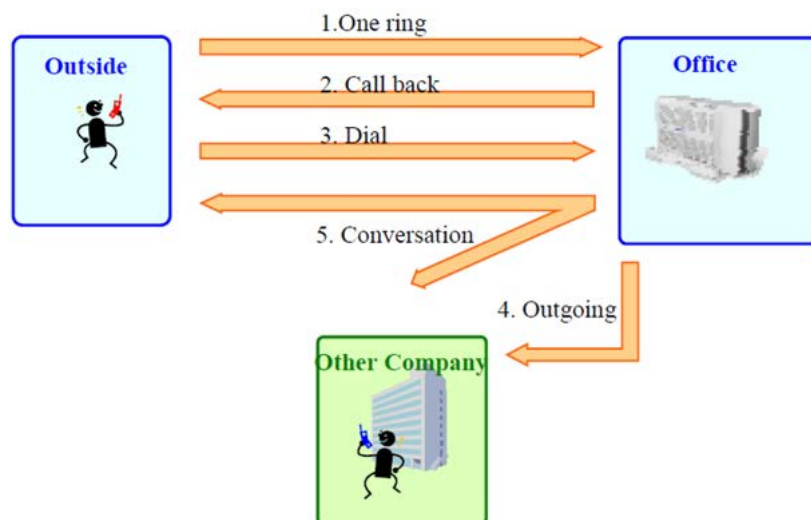

### Conditions

- Mobile Extension must be programmed for this feature to work.
- In the Callback to Cell Phone feature set Program 15-22-04 to 1. If the Cell Phone user continues to ring over the time set in Program 22-01-12, the system answers the call as a normal Mobile Extension call.
- Callback to Cell Phone will not proceed and no retry is made if all trunks are busy when trying to callback.
- Callback trunk routing follows Program 15-22-03 setting. When set 0 (Normal trunk access code), ARS also can be used.
- If Mobile Extension does not answer the Callback within time set in Program 20-01-16, Callback will stop. If answered the within the Callback time, the user hears an extension dial tone. A splash tone is not heard.



- If the system receives a “Disconnect” from the far end after a Callback is made, Callback will stop.
- When Calling party number is used, Callback follows the Program 21-19-01 outgoing call setting of the Mobile Extension which made the outgoing call.
- The Callback to Cell Phone feature is not supported when using an analog trunk.
- If Flexible ringing is set, the Callback to Cell Phone feature works in any type of Program 22-02-01 trunk setting. If Flexible ringing is not set, the Callback to Cell Phone feature does not work if the incoming call type is “DID/DISA”.
- After answering Callback, if the system does not receive a DTMF signal from the Mobile Extension using Program 20-18-01 (Default; 30 seconds), the system disconnects the call.
- The trunk user for SMDR for Callback is tied to the extension number of Mobile Extension.
- If the user calls a Mobile Extension port during while using the Callback to Cell Phone feature, the caller hears a busy tone.
- The Callback to Cell Phone feature can be used on the K-CCIS network. Netlink can be used for the Callback line, but not for the incoming line.

## Default Settings

No Mobile Extensions are configured.

## System Availability

### Terminals

All Multiline Terminals

### Required Component(s)

None

## Related Features

- ➔ **Caller ID**
- ➔ **Call Forwarding**
- ➔ **Direct Inward Dialing (DID)**
- ➔ **Direct Inward Line (DIL)**
- ➔ **Speed Dial – System/Group/Station**
- ➔ **Station Message Detail Recording**

## Guide to Feature Programming

The **Level 1**, **Level 2** and **Level 3** columns indicate the programs that are assigned when programming this feature in the order they are most commonly used. These levels are used with PCPro and WebPro wizards for feature programming.

- Level 1 – these are the most commonly assigned programs for this feature.
- Level 2 – these are the next most commonly assigned programs for this feature.
- Level 3 – these programs are not often assigned and require an expert level working knowledge of the system to be properly assigned.

### Mobile Extension:

Program Number	Program Name/Description	Input Data	Default	Level		
				1	2	3
11-02-01	<b>Extension Numbering</b> The Mobile Extension port must be an unequipped extension port on the SV9100 system. This extension port is directed to an Abbreviated Dial bin.	Maximum of eight digits.	1 101 2 102 3 103 ~ ~ 99 199 100 3101 ~ ~ 960 3961	✓		
11-10	<b>Service Code Setup (for System Administrator)</b> Customize the System Administrator service codes.		Refer to the Programming Manual for default values.		✓	
11-11	<b>Service Code Setup (for Setup/Entry Operation)</b> Customize the service code for Setup and Entry.		Refer to the Programming Manual for default values.		✓	
11-12	<b>Service Code Setup (for Service Access)</b> Customize the service codes for Service Access.		Refer to the Programming Manual for default values.		✓	
11-13	<b>Service Code Setup (for Contact Center)</b> Customize the service codes which are used with the Contact Center.		Refer to the Programming Manual for default values.		✓	
13-04-01	<b>Speed Dialing Number and Name – Speed Dialing Data</b> For the bin number defined in Program 15-22-01 for the Mobile Extension, enter the external number of the Mobile Extension. This must exactly match the Caller ID number of the Mobile Extension or the user cannot access the internal features.	(Maximum 24 digits) 1 ~ 9, 0, *, # Pause (Press line key 1) Recall/Flash (Press line key 2) @ = Code to wait for answer supervision in ISDN (Press line key 3)	No Setting	✓		

Program Number	Program Name/Description	Input Data	Default	Level		
				1	2	3
14-01-24	<b>Basic Trunk Data Setup – Trunk-to-Trunk Outgoing Caller ID through Mode</b> Enable/Disable the ability to send the original Caller ID through.	0 = Disable (No) 1 = Enable (Yes)	0		✓	
15-07-01	<b>Programmable Function Keys</b> Assign a function key for Barge-In (code 34). Optional additional data can be assigned as extension number or *.	Line Key 1 ~ 48 0 ~ 99 (Normal Function Code 751 by default) *00 ~ *99 (Appearance Function Code) (Service Code 752 by default)	Refer to the Programming Manual for default values.		✓	
15-22-01	<b>Mobile Extension Setup – Mobile Extension Target Setup</b> For each Mobile Extension number, select the Abbreviated Dial bin number to be associated with it.	0 ~ 9999 (0 = No setting 1 ~ 9999 = target of mobile extension)	0	✓		
15-22-02	<b>Mobile Extension Setup – Connect Confirmation</b> As the Mobile Extension can be a GSM phone, it is necessary to be certain a person and not, for example, a GSM voice mail has answered the call. This is achieved by returning Music on Hold/ring tone to the Mobile Extension on answer, after which the Mobile Extension user presses * to connect the call. For each Mobile Extension number, select whether the user needs to use DTMF confirmation before a call is answered. Until the * is pressed, the call is treated as not being answered.	0 = Always 1 = On analog line 2 = Never	0	✓		
15-22-03	<b>Mobile Extension Setup – Trunk Access Code</b> Select whether the Normal or Individual Trunk access is used when making the call to the mobile number.	0 = Use normal trunk access code (Program 11-09-01) 1 = Use individual trunk access code (Program 11-09-02)	0	✓		
15-22-04	<b>Mobile Extension Setup – Call Back</b> Select whether or not the system will try to call back a mobile extension user.	0 = Don't call back 1 = Call back	0		✓	
20-01-16	<b>System Options – Mobile Extension Callback Duration Time</b> Determines the amount of time the system will call back a mobile extension user before abandoning the call.	0 ~ 64800 seconds	15		✓	
20-01-20	<b>System Options – Progress Tone for Mobile Extension Setting</b> Select whether the Progress Tone (1) or Ringback (0) is played to the Internal Caller until the call to the Mobile Extension is setup.	0 = Disable 1 = Enable	1		✓	

Program Number	Program Name/Description	Input Data	Default	Level		
				1	2	3
20-03-04	<b>System Options for Single Line Telephones – Dial Sending Start Time for SLT or ARS</b> When an extension user dials a Mobile Extension number, the system waits this time before dialing the number.	0 ~ 64800 seconds	3		✓	
20-09-02	<b>Class of Service (Incoming Call Service) – Caller ID Display</b> Turns Off or On the Caller ID display at an extension.	0 = Off 1 = On	COS 1 ~ 15 = 0	✓		
21-12-01	<b>ISDN Calling Party Number Setup for Trunks</b> Assign Calling Party Numbers for each trunk (maximum 16 digits per entry). When a call is made by an extension which does not have an Extension Calling Number assigned (Program 21-13), the system sends the calling number for the ISDN trunk defined in 21-12. If the Calling Party Number is assigned in both Program 21-12 and Program 21-13, the system sends the data in Program 21-13.	Maximum of 16 digits. (1-0, *, #)	No Setting		✓	
21-13-01	<b>ISDN Calling Party Number Setup for Extensions</b> Assign each extension a Calling Party Number (maximum 16 digits per entry). The calling number is the subscriber number of the dial-in number. When a call is made by an extension which does not have an Extension Calling Number assigned (Program 21-12), the system sends the calling number for the ISDN trunk defined in Program 21-13. If a Calling Party Number is assigned in both Program 21-12 and Program 21-13, the system sends the data in Program 21-13.	Maximum of 16 digits. (0 ~ 9, *, #)	No Setting		✓	
22-01-12	<b>System Options for Incoming Calls – Mobile Extension Answer Time</b> Determines the amount of time before the mobile extension will answer with internal dial tone. Extend this timer long enough for 1 ring cycle to complete, giving the mobile extension user time to hang up and wait for callback.	0 ~ 64800 seconds	3	✓		
22-11-01	<b>DID Translation Number Conversion – Received Number</b> Define the digits received by the system for the telephone number on which a Mobile Extension user calls into the system.	Maximum of eight digits.	No Setting	✓		
22-11-02	<b>DID Translation Number Conversion – Target Number</b> For the DID number defined in Program 22-11-01, enter the extension number for the Mobile Extension user.	Maximum of 24 digits.	No Setting	✓		

Program Number	Program Name/Description	Input Data	Default	Level		
				1	2	3
22-11-13	<p><b>DID Translation Number Conversion – Identify for Mobile Extension</b></p> <p>Determines when a Mobile Extension number calls in on a DID if it will provide an Internal Tone (1) or route the call as programmed (0).</p>	<p>0 = Off 1 = On</p>	0	✓		
80-01-01	<p><b>Service Tone Setup – Tone 44, External Dial Tone</b></p> <p>It is necessary to adjust the DID/DISA dial tone (tone 44) to a Repeat Count of 250 (by default, this is set to 0). The system must be reset for this change to take affect.</p>	0 ~ 255 (0 = until On-Hook)	Refer to <a href="#">Table 2-33 Service Tone Setup Defaults, Program 80-01-01 on page 2-594.</a>		✓	
80-01-01	<p><b>Service Tone Setup – Tone 54, Progress Tone</b></p> <p>By default, when calling a Mobile Extension, the Progress Tone is played to the caller.</p>		Refer to <a href="#">Table 2-33 Service Tone Setup Defaults, Program 80-01-01 on page 2-594.</a>		✓	
80-01-01	<p><b>Service Tone Setup – Tone 57, Off-Hook Beep Tone - Headset Earpiece ringing Tone</b></p> <p>If required, change the tone heard when a Mobile Extension user goes off hook to answer a call prior to pressing *. The system must be reset for this change to take affect.</p>		Refer to <a href="#">Table 2-33 Service Tone Setup Defaults, Program 80-01-01 on page 2-594.</a>		✓	
80-03-01	<p><b>DTMF Tone Receiver Setup – Detect Level</b></p> <p>Select the Detect Level to be used for DTMF Tone detection. For the extension DTMF, this entry must allow for a detection of -25dBm. Set the minimum detection level in Program 80-03-03. The system must be reset for this change to take affect.</p>	<p>0 = 0dBm ~ -25dBm 1 = -5dBm ~ -30dBm 2 = -10dBm ~ -35dBm 3 = -15dBm ~ -40dBm 4 = -20dBm ~ -45dBm 5 = -25dBm ~ -50dBm 6 = -30dBm ~ -55dBm</p>	Type 1 ~ 5 = 0		✓	

Program Number	Program Name/Description	Input Data	Default	Level		
				1	2	3
80-03-03	<p><b>DTMF Tone Receiver Setup – Min. Detect Level</b></p> <p>For the extension DTMF, the minimum Detect Level (0-15) for the DTMF Tone must be set to allow a minimum detection level of -25dBm. This entry is dependent on the Detect Level selected in Program 80-03-01. For example, if Detect Level 0 were selected in Program 80-03-01, the entry in this option would be 15 for -25dBm. The system must be reset for this change to take affect.</p>	<p>0 ~ 15</p> <p>detect level 0: -10dBm(0) to -25dBm(15)</p> <p>detect level 1: -15dBm(0) to -30dBm(15)</p> <p>detect level 2: -20dBm(0) to -35dBm(15)</p> <p>detect level 3: -25dBm(0) to -40dBm(15)</p> <p>detect level 4: -30dBm(0) to -45dBm(15)</p> <p>detect level 5: -35dBm(0) to -50dBm(15)</p> <p>detect level 6: -40dBm(0) to -55dBm(15)</p> <p>detect level 7: -45dBm(0) to -60dBm(15)</p> <p>detect level 8: -50dBm(0) to -65dBm(15)</p> <p>detect level 9: -55dBm(0) to -70dBm(15)</p> <p>detect level 10: -60dBm(0) to -75dBm(15)</p> <p>detect level 11: -65dBm(0) to -80dBm(15)</p> <p>detect level 12: -70dBm(0) to -85dBm(15)</p> <p>detect level 13: -75dBm(0) to -90dBm(15)</p> <p>detect level 14: -80dBm(0) to -95dBm(15)</p> <p>detect level 15: -85dBm(0) to -100dBm(15)</p>	<p>Type 1 = 10 (-20dBm)</p> <p>Type 2 ~ 3 = 15 (-25dBm)</p> <p>Type 4 ~ 5 = 10 (-20dBm)</p>		✓	

Callback to Cell Phone:

Program Number	Program Name/Description	Input Data	Default	Level		
				1	2	3
13-04-01	<b>Speed Dialing Number and Name – Speed Dialing Data</b> Enter the Common and Group Speed Dialing numbers and names which are to be used for Trunk-to-Trunk Forwarding.	(Maximum of 24 digits) 1~9, 0, *, # Pause (Press line key 1) Recall/Flash (Press line key 2) @ = Code to wait for answer supervision in ISDN (Press line key 3)	No Setting	✓		
13-04-03	<b>Speed Dialing Number and Name – Transfer Mode</b> When the incoming caller ID matches the number programmed in the speed dial bin, this setting determines the destination of the call.	0 = Not Used 1 = Internal Dial 2 = Incoming Ring Group (IRG)	0	✓		
13-04-04	<b>Speed Dialing Number and Name – Transfer Destination Number</b> When the incoming caller ID matches the number programmed in the speed dial bin, this setting determines the destination of the call. Set up the transfer destination number or the IRG number.	If Transfer mode is (Refer to Program 13-04-03): 1 = Internal Dial Mode 1 ~ 9, 0, *, #, P, R, @ (Maximum 24 Characters) 2 = Incoming Ring Group 0 ~ 100 (IRG Number) P = Pause R = Recall @ = Additional Digits when using ISDN functionality	No Setting	✓		
14-01-30	<b>Basic Trunk Data Setup – Flexible Ringing by Caller ID</b> Enable/Disable Flexible ringing on each Trunk port base.	0 = Disable 1 = Enable	1	✓		
15-22-01	<b>Mobile Extension Setup – Mobile Extension Target Setup</b> For each Mobile Extension number, select the Abbreviated Dial bin number to be associated with it.	0 ~ 9999 (0 = No setting 1 ~ 9999 = target of mobile extension)	0	✓		
15-22-03	<b>Mobile Extension Setup – Trunk Access Code</b> Select whether the Normal or Individual Trunk access is used when making the call to the mobile number.	0 = Use normal trunk access code (Program 11-09-01) 1 = Use individual trunk access code (Program 11-09-02)	0	✓		
15-22-04	<b>Mobile Extension Setup – Call Back</b> Select whether or not the system will try to call back a mobile extension user.	0 = Don't call back 1 = Call back	0		✓	
20-01-16	<b>System Options – Mobile Extension Callback Duration Time</b> Determines the amount of time the system will call back a mobile extension user before abandoning the call.	0 ~ 64800 seconds	15		✓	

Program Number	Program Name/Description	Input Data	Default	Level		
				1	2	3
20-31-24	<b>Timer Class Timer Assignment – Answer Time from Mobile Extension</b> This program defines the data corresponding to Program 22-01-12. Refer to Timer Class for Extension.	0 ~ 64800 seconds (0 = Immediate Answer)	3		✓	
20-31-25	<b>Timer Class Timer Assignment – Mobile Extension Callback Duration Time</b> This program defines the data corresponding to Program 22-01-12. Refer to Timer Class for Extension.	0 ~ 64800 seconds	15		✓	
22-01-12	<b>System Options for Incoming Calls – Mobile Extension Answer Time</b> Determines the amount of time before the mobile extension will answer with internal dial tone. Extend this timer long enough for 1 ring cycle to complete, giving the mobile extension user time to hang up and wait for callback.	0 ~ 64800 seconds	3	✓		

## Operation

With any feature, if the Mobile Extension user presses \*, an existing call is placed in hold. Pressing \* a second time or the timeout of the inter-digit timer returns the call to conversation mode.

### Using Analog Lines with the Mobile Extension

Analog lines can be used for integration with the Mobile Extension using either DILs or VRS Auto Attendant to access the Mobile Extension Proxy Port. However, it must be noted that the \*0 Hang Up code must be used prior to terminating any call (e.g., transfer, hang up etc.) as analog trunks do not provide Disconnect Supervision.

### Placing an Intercom Call to a Mobile Extension

- Lift the handset or press **SPK**.
- Dial the extension number assigned to the Mobile Extension.  
 If the Mobile Extension is turned off, incoming callers hear a message indicating the user is not available. The setting in the DTMF Confirmation programming (Program 15-22-02) determines how the call is handled.
 

**Program 15-22-02 set to 0 or 1 (DTMF Confirmation Required):**  
 The caller is retrieved by the UNIVERGE SV9100 and follows the no-answer programming (ring another extensions, forward to UNIVERGE SV9100 voice mail, etc.)

**Program 15-22-02 set to 2 (No DTMF Confirmation Required):**  
 The caller is forwarded to the external extension voice mail, if available.



### Outside Party Dialing the Mobile Extension

1. Dial the DID or DIL telephone number for the Mobile Extension.  
System programming (DID=22-11-01 or DIL=22-07-01) must be defined.  
If the Mobile Extension is turned off, incoming callers hear a message indicating the user is not available. The setting in the DTMF Confirmation programming (Program 15-22-02) determines how the call is handled.  
**Program 15-22-02 set to 0 or 1 (DTMF Confirmation Required):**  
The caller is retrieved by the SV9100 and follows the no-answer programming (ring another extension, forward to SV9100 voice mail, etc.)  
**Program 15-22-02 set to 2 (No DTMF Confirmation Required):**  
The caller is forwarded to the external extension voice mail, if available.

### Placing a Call from the Mobile Extension

1. Dial the DID or DIL telephone number for the Mobile Extension.  
If the Caller ID of the Mobile Extension matches the Speed Dial bin entry (Program 13-04 and 15-22), internal dial tone is heard by the Mobile Extension user.
2. Dial the desired Intercom number or dial the trunk access code to place an outgoing call.

### Answering a Call on the Mobile Extension

1. Answer the ringing call.
2. If Program 15-22-02 is set to 0 or 1, the Mobile Extension user hears Music on Hold/ring tone. Press \* (within 10 seconds) to answer the call.  
This step is required when using analog trunks for the Mobile Extension feature.

### Sending a Flash from the Mobile Extension

1. While on a conversation, a hook flash is returned by dialing \*# from the Mobile Extension.

### Internal Dial Tone After Hang Up

1. When a call is finished, disconnect the call and receive internal dial tone by dialing \*0.

### Placing/Retrieving a Call on Hold from the Mobile Extension

1. While on a call, press \* #.
2. To retrieve the held call, with system dial tone, press \* #.

### Swapping Between Two Held Calls from the Mobile Extension

1. While on a call, press \* #.  
The first call is placed on Hold.
2. Place second call, then place on Hold by pressing \* #.  
The second call is placed on Hold and the first call is picked up.
3. The Mobile Extension can connect the two held calls with Automatic On-Hook Transfer if Program 20-11-11 is enabled by dialing \* 0.

### Transferring a call from the Mobile Extension

1. With an active call, press \* #.
2. Dial the extension number to which the call is to be transferred.
3. Dial \* 0.
4. Hang up.

### Call Forwarding

When setting Call Forwarding from the Mobile Extension, the service code(s) must be defined in Programs 11-11-01~11-11-05 and 11-11-07.

#### To activate or cancel Call Forwarding to/from the Mobile Extension:

1. **When activating Call Forwarding From the Mobile Extension:**  
Dial the DID or DIL telephone number for the Mobile Extension.  
If the Caller ID of the Mobile Extension matches the Speed Dial bin entry (Program 13-04 and 15-22), internal dial tone is heard by the Mobile Extension user.

**-OR-**

When activating Call Forwarding to the Mobile Extension:

Press **CALL** key or lift the handset.

2. Dial the service code defined in Program 11-11-01~11-11-05 and.
3. Dial Call Forwarding condition:  
1 = Set  
0 = Cancel
4. Dial the destination extension or Off-Premise number.
5. Dial \* 0 (from Mobile Extension only).
6. Hang up.

**To activate Call Forward Follow Me:**

1. **When activating Call Forwarding From the Mobile Extension:**  
Dial the DID or DIL telephone number for the Mobile Extension.  
If the Caller ID of the Mobile Extension matches the Speed Dial bin entry (Program 13-04 and 15-22), internal dial tone is heard by the Mobile Extension user.

**-OR-**

When activating Call Forwarding to the Mobile Extension:  
Press **SPK** or lift the handset.

2. Dial 746.
3. Dial Call Forwarding condition:  
1 = Set  
0 = Cancel
4. Dial the destination extension.
5. Dial \* 0 (from Mobile Extension only).
6. Hang up.

**To cancel Call Forward Follow Me:**

1. **When activating Call Forwarding From the Mobile Extension:**  
Dial the DID or DIL telephone number for the Mobile Extension.  
If the Caller ID of the Mobile Extension matches the Speed Dial bin entry (Program 13-04 and Program 15-22), internal dial tone is heard by the Mobile Extension user.

**-OR-**

When activating Call Forwarding to the Mobile Extension:  
Press **SPK** or lift the handset.

2. Dial 746.
3. Dial **0**.
4. Dial destination Station to Cancel Forward Follow Me extension or Dial 0 to cancel all.
5. Dial \***0** (from Mobile Extension only).
6. Hang up.

## Receive Callback

### Receive call from Mobile Extension and Callback:

Cell phone number: 09012345678

Incoming trunk set up: 22-02: Trk1, DIL

Mobile Extension set up: Ext150

Program 15-22-01: Speed Dial bin No, 50

Program 15-22-03: Trunk access code, 0: Use normal trunk access code

Program 15-22-04: Callback, (1) Enable

Speed Dial bin set up: No.50

Program 13-04-01: 09012345678

Program 13-04-03: Transfer mode, (1) Extension

Program 13-04-04: Destination, 150

Callback timer set up

Program 22-01-12: Answer time from Mobile Extension, 3 seconds

Program 20-01-16: Mobile Extension Callback Duration time, 15 seconds

Program 20-18-01: Extension Dial Tone Time, 30 seconds

1. Call the system Trk1 from the cell phone setting as a mobile extension (Ex 150).
2. The Cell Phone user hangs up within 3 seconds, before system answers.
3. System makes the Callback to the cell phone.
4. Answer the cell phone within 15 seconds.
5. Cell phone hears a dial tone and dials \* before 30 seconds.

### Receive call from Mobile Extension, but system answered:

1. Call the system Trk1 from the cell phone setting as a mobile extension (Ex 150).
2. Cell Phone user continues ring for longer than 3 seconds, then system answers.
3. Cell phone user hears a dial tone.

### Cell phone does not answer to Callback:

1. Call the system Trk1 from the cell phone setting as a mobile extension (Ex 150).
2. The Cell Phone user hangs up within 3 seconds, before system answers.
3. System makes the Callback to the cell phone.
4. The Cell phone does not answer the call within 15 seconds.
5. System disconnects the call.

**After Callback answered, but does not send any DTMF:**

1. Call the system Trk1 from the cell phone setting as a mobile extension (Ex 150).
2. The Cell Phone user hangs up within 3 seconds, before system answers.
3. System makes the Callback to the cell phone.
4. The Cell Phone answers within 15 seconds.
5. The Cell phone hears a dial tone but does not send any DTMF within 30 seconds.
6. System disconnects the call.

## Mobile Extension – Answer Park Hold

### Description

With Version 4000 or higher software, Mobile Extension can answer a park call automatically or by manually dialing the answer park hold service code through a DID Trunk.

### Conditions

- This feature also works with DID Mode Switching.
- If there is an error with the assigned service code, the call is transferred using the settings in Program 22-11.
- Watch Mode can be started or stopped automatically or by manually dialing the service code.
- Mobile Extension can access the doorphone automatically or by manually dialing the service code.
- General Purpose Relay can be enabled or disabled automatically or by manually dialing the service code.
- The Security Sensor Reset can be set automatically or by manually dialing the service code.
- Security Sensor Mode Start can be started or stopped automatically or by manually dialing the service code.
- Program 22-11-13 must be enabled for manual dialing.
- The Mobile Extension uses the \* to perform a flash, any service codes which begin with \* must be changed (Programs 11-10, 11-11, 11-12, 11-13).

### Default Settings

None

### System Availability

#### Terminals

All Terminals

#### Required Component(s)

0414 – SV9100 Version Lic (R4)

## Related Features

- ➔ [Door Box](#)
- ➔ [General Purpose Relay](#)
- ➔ [Mobile Extension](#)
- ➔ [Park](#)
- ➔ [Security](#)

## Guide to Feature Programming

The **Level 1**, **Level 2** and **Level 3** columns indicate the programs that are assigned when programming this feature in the order they are most commonly used. These levels are used with PCPro and WebPro wizards for feature programming.

- Level 1 – these are the most commonly assigned programs for this feature.
- Level 2 – these are the next most commonly assigned programs for this feature.
- Level 3 – these programs are not often assigned and require an expert level working knowledge of the system to be properly assigned.

Program Number	Program Name/Description	Input Data	Default	Level		
				1	2	3
11-12-32	<b>Service Code Setup (for Service Access) – Answer for Park Hold</b> Assign a key on the multiline terminal or single line telephone for park hold.	MLT, SLT Maximum of eight digits 0 ~ 9, *, #	*6	✓		
11-12-36	<b>Service Code Access (for Service Access) – Door Box Access</b> If the service code for Doorphone Access is not acceptable, change it here.	MLT, SLT Maximum of eight digits 0 ~ 9, *, #	702		✓	
11-12-50	<b>Service Code Setup (for Service Access) – General Purpose Relay</b> This is the access code to enable/disable the General Purpose relays. After dialing the service code the user must then dial the relay (0 ~ 8) to enable/disable the relays. 0 = Relay on GCD-CP10 1 ~ 8 = Relay assigned on PGD	MLT, SLT Maximum of eight digits 0 ~ 9, *, #	780		✓	
11-12-62	<b>Service Code Setup (for Service Access) – Security Sensor Reset</b> Service Code setting for cancel Warning message sending and emergency call.	MLT, SLT Maximum of eight digits 0 ~ 9, *, #	716(NA/AT)/ 837(OT)		✓	

Program Number	Program Name/Description	Input Data	Default	Level		
				1	2	3
11-12-63	<b>Service Code Setup (for Service Access) – Watch Mode Start</b> Service Code (SC) setting for on/off watch mode. SC+1; Watch mode start SC+0; Watch mode end.	MLT, SLT Maximum of eight digits 0 ~ 9, *, #	717(NA/AT)/ 817(OT)		✓	
11-12-64	<b>Service Code Setup (for Service Access) – Security Sensor Mode Start</b> Service code + 1, after the timer (Program 20-55-01) passes, sensor signal is valid. Service code + 0, sensor signal is invalid.	MLT, SLT Maximum of eight digits 0 ~ 9, *, #	719(NA/AT)/ 819(OT)		✓	
13-04-01	<b>Speed Dialing Number and Name – Speed Dialing Data</b> For the bin number defined in Program 15-22-01 for the Mobile Extension, enter the external number of the Mobile Extension. This must exactly match the Caller ID number of the Mobile Extension or the user cannot access the internal features.	Maximum of 24 digits (0 ~ 9, *, #, @, P, R) @ = Wait for Answer Supervision - ISDN trunks only P = Pause - Analog Trunk Only R = Hook flash - Analog Trunk Only	No Setting	✓		
15-22-01	<b>Mobile Extension Setup – Mobile Extension Target Setup</b> For each Mobile Extension number, select the Abbreviated Dial bin number to be associated with it.	0 ~ 9999 (0 = No setting 1 ~ 9999 = target of mobile extension)	0	✓		
22-02-01	<b>Incoming Call Trunk Setup</b> For each Night Service Mode, assign service type 3 when the trunk should be a DID trunk or assign service type 8 when the trunk should be a DID (DDI) Mode Switching trunk.	Incoming Type for Day/Night Mode (1 ~ 8): 0 = Normal 1 = VRS (second dial tone if no VRS installed) 2 = DISA 3 = DID 4 = DIL 5 = E&M Tie line 6 = Delayed VRS 7 = ANI/DNIS 8 = DID(DDI) Mode Switching	0		✓	
22-09-01	<b>DID Basic Data Setup – Expected Number of Digits</b> For each DID Translation Table (1 ~ 20), enter the number of digits the table expects to receive from the CO (eight maximum). For example, for a table used with 3-digit DID service, enter 3.	1 ~ 8	4	✓		
22-11-01	<b>DID Translation Number Conversion – Received Number</b> For each DID Translation Table entry (1 ~ 4000), specify the digits received by the system.	Maximum of eight digits	No Setting	✓		



Program Number	Program Name/Description	Input Data	Default	Level		
				1	2	3
22-11-02	<b>DID Translation Number Conversion – Target Number</b> For each DID Translation Table entry (1 ~ 4000), specify the extension the system dials after translation.	Maximum of eight digits	No Setting	✓		
22-11-05	<b>DID Translation Table Number Conversion – Transfer Destination Number 1</b> Define the 1st transfer destination for each tables received number.	0 = No Setting 1 ~ 100 = Incoming Group 101 = (Not Used) 102 = In-Skin/External Voice Mail or InMail 201 ~ 264 = Extension Group 400 = Valid Extension Number 401 = DISA 501 ~ 599 = DISA/VRS Message 1000 ~ 1999 = Speed Dial Number (000 ~ 999)	0		✓	
22-11-06	<b>DID Translation Table Number Conversion – Transfer Destination Number 2</b> Define the second transfer destination for each tables received number.	0 = No Setting 1 ~ 1 00 = Incoming Group 101 = (Not Used) 102 = In-Skin/External Voice Mail or InMail 201 ~ 264 = Extension Group 400 = Valid Extension Number 401 = DISA 501 ~ 599 = DISA/VRS Message 1000 ~ 1999 = Speed Dial Number (000 ~ 999)	0		✓	
22-11-11	<b>DID Translation Number Conversion – Ring Group Transfer</b> Enable/Disable each conversion table to follow the Ring Group programming defined in Program 22-12-01: DID Intercept Ring Group. If Program 22-11-05: DID Translation Number Conversion, Transfer Destination Number 1 and Program 22-11-06: DID Translation Number Conversion, Transfer Destination Number 2 are set, the priority of transferring is in this order: Program 22-11-05 then Program 22-11-06 then if Program 22-11-11 is enabled, Program 22-12-01.	0 = Disable (Caller hears Ringback) 1 = Enable (Go to normal ring)	1		✓	
22-11-13	<b>DID Translation Number Conversion – Identify for Mobile Extension</b> Determines when a Mobile Extension number calls in on a DID if it will provide an Internal Tone (1) or route the call as programmed (0).	0 = Off 1 = On	0	✓		

## Operation

### Answer Park Call

#### To automatically answer the Park Call using the service code:

1. Set desired service code for answering the Park Call in Program 22-11-02 (Park Hold Answer service code+XXYY as DID target 1. For example: 7840101).  
XX = Park group hold number  
YY = Park Orbit Number (1~64)
2. Make a call to defined DID trunk from Mobile Extension.
  - ◇ *The parked call is automatically answered.*

#### To answer the Park Call by manually dialing the service code:

1. Make a call to defined DID trunk from Mobile Extension.
  - ◇ *Mobile extension will get an internal dial tone.*
  - ◇ *Program 22-11-13 must be enabled for manual dialing.*
2. Dial Park Hold Answer service code+park orbit number 1~64 (For example: 784+01).

#### To automatically start the Watch mode using the service code:

1. Set desired service code in Program 22-11-02 (717+1 as DID target 1).
2. Make a call to defined DID trunk from Mobile Extension.
  - ◇ *Starts the watch mode automatically.*

#### To automatically stop the Watch mode using the service code:

1. Set desired service code in Program 22-11-02 (717+0 as DID target 1).
2. Make a call to defined DID trunk from Mobile Extension.
  - ◇ *Stops the watch mode automatically.*

#### To start the Watch mode by manually dialing the service code:

1. Make a call to defined DID trunk from Mobile Extension.
  - ◇ *Mobile extension will get an internal dial tone.*
  - ◇ *Program 22-11-13 must be enabled for manual dialing.*
2. Dial 717+1.

**To stop the Watch mode by manually dialing the service code:**

1. Make a call to defined DID trunk from Mobile Extension.
  - ◇ *Mobile extension will get an internal dial tone.*
  - ◇ *Program 22-11-13 must be enabled for manual dialing.*
2. Dial 717+0.

**To automatically call a Door Box using the service code:**

1. Set desired service code in Program 22-11-02 (702+ Door Box number 1~8 as DID target 1).
2. Make a call to defined DID trunk from Mobile Extension.
  - ◇ *Calls the Door Box automatically.*

**To call a Door Box by manually dialing the service code:**

1. Make a call to defined DID trunk from Mobile Extension.
  - ◇ *Mobile extension will get an internal dial tone.*
  - ◇ *Program 22-11-13 must be enabled for manual dialing.*
2. Dial 702.
3. Dial Door Box number (1~8).

**To automatically activate a Relay using the service code:**

1. Set desired service code in Program 22-11-02 (780+ Relay number 0~8 as DID target 1).
  - ◇ *0 is for the relay on the GCD-CP10, 1~8 are relays on the PGD(2)-U10 ADP.*
2. Make a call to defined DID trunk from Mobile Extension.
  - ◇ *Activates the relay automatically.*

**To automatically cancel a Relay using the service code:**

1. Set desired service code in Program 22-11-02 (780+ Relay number 0~8 as DID target 1).
  - ◇ *0 is for the relay on the GCD-CP10, 1~8 are relays on the PGD(2)-U10 ADP.*
2. Make a call to defined DID trunk from Mobile Extension.
  - ◇ *Cancels the relay automatically.*

**To activate a Relay by manually dialing the service code:**

1. Make a call to defined DID trunk from Mobile Extension.
  - ◇ *Mobile extension will get an internal dial tone.*
  - ◇ *Program 22-11-13 must be enabled for manual dialing.*
2. Dial 780.
3. Dial Relay number (0~8).

**To cancel a Relay by manually dialing the service code:**

1. Make a call to defined DID trunk from Mobile Extension.
  - ◇ *Mobile extension will get an internal dial tone.*
  - ◇ *Program 22-11-13 must be enabled for manual dialing.*
2. Dial 780.
3. Dial Relay number (0~8).

**Security Sensor reset automatically by dialing the service code:**

1. Set desired service code in Program 22-11-02 (716 as DID target 1).
2. Make a call to defined DID trunk from Mobile Extension.
  - ◇ *Security Sensor resets automatically.*

**Security Sensor reset by manually dialing the service code:**

1. Make a call to defined DID trunk from Mobile Extension.
  - ◇ *Mobile extension will get an internal dial tone.*
  - ◇ *Program 22-11-13 must be enabled for manual dialing.*
2. Dial 716.

**To set the Security Sensor Mode Start using the service code:**

1. Set desired service code in Program 22-11-02 (719+1 as DID target 1).
2. Make a call to defined DID trunk from Mobile Extension.
  - ◇ *The Security Sensor mode starts automatically.*

**To Cancel the Security Sensor Mode Start using the service code:**

1. Set desired service code in Program 22-11-02 (719+0 as DID target 1).
2. Make a call to defined DID trunk from Mobile Extension.
  - ◇ *The Security Sensor mode cancels automatically.*

**To set Security Sensor Mode Start by manually dialing the service code:**

1. Make a call to defined DID trunk from Mobile Extension.
  - ◇ *Mobile extension will get an internal dial tone.*
  - ◇ *Program 22-11-13 must be enabled for manual dialing.*
2. Dial 719+1.

**To cancel Security Sensor Mode Start by manually dialing the service code:**

1. Make a call to defined DID trunk from Mobile Extension.
  - ◇ *Mobile extension will get an internal dial tone.*
  - ◇ *Program 22-11-13 must be enabled for manual dialing.*
2. Dial 719+0.

## Multiple Trunk Types

### Description

The UNIVERGE SV9100 supports many different Trunks in the system (DID, E&M Tie Lines, Loop Start, Ground Start, ISDN BRI, ISDN PRI, and T-1 trunks). The system supports up to 400 trunks in the expanded port package, and a maximum of 56 trunks in the basic port package.

#### DID

Refer to the [Direct Inward Dialing \(DID\) on page 2-418](#) feature for related information.

#### E&M Tie Lines

E&M Tie Lines (4-Wire) can be connected to the system to provide communication between remote systems and facilities. The system can receive and/or transmit DTMF or DP signals on E&M Tie Lines.

#### Ground Start Trunks

Ground Start Trunks can be connected to the system. Ground and Loop Start Trunks can be mixed in the system per trunk. Ground Start Trunks are provided with line supervision to reduce call collisions.

#### Loop Start Trunks

Loop Start Trunks can be connected to the UNIVERGE SV9100 system. Loop Start is assigned per trunk at the associated blade. Ground Start and Loop Start Trunks can be mixed in the system per trunk.

#### ISDN BRI

Refer to the [ISDN Compatibility on page 2-987](#) feature for related information.

#### ISDN PRI

Refer to the [ISDN Compatibility on page 2-987](#) feature for related information.

#### T-1 Trunks

Refer to the [T1 Trunking \(with ANI/DNIS Compatibility\) on page 2-1601](#) feature for related information.

### Conditions

- Each GCD-4ODTA supports four 4-wire E&M Tie Lines.
- Ground Start Trunks do not support Caller ID.
- When adding or removing padding for trunks, use Program 14-01 for all trunks.

## Default Settings

None

## System Availability

### Terminals

All Terminals

### Required Component(s)

Any Trunk Blade

## Related Features

- ➔ **Automatic Route Selection (ARS)**
- ➔ **Caller ID**
- ➔ **Call Appearance (CAP) Keys**
- ➔ **Direct Inward Dialing (DID)**
- ➔ **ISDN Compatibility**
- ➔ **T1 Trunking (with ANI/DNIS Compatibility)**

## Guide to Feature Programming

The **Level 1**, **Level 2** and **Level 3** columns indicate the programs that are assigned when programming this feature in the order they are most commonly used. These levels are used with PCPro and WebPro wizards for feature programming.

- Level 1 – these are the most commonly assigned programs for this feature.
- Level 2 – these are the next most commonly assigned programs for this feature.
- Level 3 – these programs are not often assigned and require an expert level working knowledge of the system to be properly assigned.

Program Number	Program Name/Description	Input Data	Default	Level		
				1	2	3
14-01-01	<b>Basic Trunk Data Setup – Trunk Name</b> Set the names for trunks. The trunk name is displayed on a multiline terminal for incoming and outgoing calls.	Maximum of 12 characters.	Line 001 Line 002 Line 003 : Line 400		✓	
25-07-01	<b>System Timers for VRS/DISA – VRS/DISA Dial Tone Time</b> After answering a VRS/DISA trunk, the system waits this time for the caller to dial the first digit of the DISA password. If the caller fails to dial during this time, the system drops the call.	0 ~ 64800 seconds	10		✓	
34-01-02	<b>E&amp;M Tie Line Basic Setup – Receive Dial Type for E&amp;M Tie Line</b> For DID and tie trunks, set the trunk signaling.	0 = DP 1 = DTMF	1		✓	

**Loop Start/Ground Start Trunks:**

Program Number	Program Name/Description	Input Data	Default	Level		
				1	2	3
14-02-14	<b>Analog Trunk Data Setup – Loop Start/ Ground Start</b> Indicate if the Analog trunk is Loop Start or Ground Start.	0 = Loop Start (Loop) 1 = Ground Start (Ground)	0	✓		
14-04-01	<b>Behind PBX Setup</b> Indicate if the trunk is installed behind a PBX (1) or not (0). There is one item for each Night Service Mode.	0 = Stand Alone (Trunk) 1 = Behind PBX (PBX) 2 = Not Used 3 = CTX assume 9	0		✓	
14-05-01	<b>Trunk Group – Trunk Group Number</b> Assign trunks to Trunk Groups. You can also assign the outbound priority for trunks in the group. When users dial the trunk group, they seize the trunks in the order you specify in the outbound priority entry.	Trunk Port 1 ~ 400 Group Number 0 ~ 100 Priority 1 ~ 400	Default = Trunks 1 ~ 400 assigned to trunk group 1 with priorities equal to the trunk number. Trunk 1 = Priority 1 Trunk 400 = Priority 400.	✓		



Program Number	Program Name/Description	Input Data	Default	Level		
				1	2	3
22-02-01	<b>Incoming Call Trunk Setup</b> For each Night Service mode, enter service type for each trunk.	0 = Normal 1 = VRS (second dial tone if no VRS installed) 2 = DISA 3 = DID 4 = DIL 5 = E&M Tie line 6 = Delayed VRS 7 = ANI/DNIS 8 = DID(DDI) Mode Switching	0	✓		
81-10-01	<b>COT Initial Data Setup – DP Interdigit Time Selection</b> Select the DP Interdigit Time (minimum pause time between Dial Pulses).	0 = Pattern A (Pattern A: 10pps – 650ms, 20pps – 500ms) 1 = Pattern B (Pattern B: 10pps – 800ms, 20pps – 800ms)	1 (Pattern B)			✓
81-10-02	<b>COT Initial Data Setup – Prepause Time Selection</b> Specify the loop open time for a hookflash signal sent to the CO or PBX when Recall on a multiline terminal is pressed. A single line telephone generates a hookflash to the CO or PBX line when a single line telephone hookflash is assigned.	1 ~ 13 (1 ~ 13 seconds) (0 = No Setting)	1 second			✓
81-10-03	<b>COT Initial Data Setup – Incoming Signal Detect Time Selection</b> Specify the time after the incoming signal from another system is detected before the acknowledge signal is sent out.	0 ~ 15 (50 ~ 800ms)	3 (200ms)			✓
81-10-04	<b>COT Initial Data Setup – Disconnect Recognition Time Selection</b> Specify the minimum time before a disconnected circuit can be accessed again.	1 ~ 15 (100ms ~ 1.5 seconds) (0 = No Setting)	3 (300ms)			✓
81-10-05	<b>COT Initial Data Setup – Auto Release Signal Detection Time</b> Specify the signal detection time for release of a CO/PBX line after a disconnect signal is received from the distant Central Office or PBX.	1 ~ 14 (50 ~ 700ms) 15 = (No limit) (0 = No Setting)	7 (350ms)			✓

## Tie Lines:

Program Number	Program Name/Description	Input Data	Default	Level		
				1	2	3
10-09-01	<b>DTMF and Dial Tone Circuit Setup</b> If the system has DTMF Tie Lines, be sure to reserve at least one circuit for analog trunk DTMF reception (type 0 or 2). ○ Use the following as a guide when allocating DTMF receivers: ➤ <i>In light traffic sites, allocate one DTMF receiver for every 10 devices that use them.</i> ➤ <i>In heavy traffic sites, allocate one DTMF receiver for every five devices that use them.</i>	0 = Common Use 1 = Extension Only 2 = Trunk Only	Circuit/Resource 01 ~ 08 = 1 (Extensions) Circuit/Resource 09 ~ 32 = 2 (Trunks) Circuit/Resource 33 ~ 144 = 0 (Common) When GPZ-BS10 is installed, 81 ~ 144 are available		✓	
14-01-02	<b>Basic Trunk Data Setup – Transmit Level</b> Customize the transmit level of the CODEC Gain for each trunk.	Trunks 1 ~ 400 1 ~ 57 (-15.5 ~ +12.5dB in 0.5dB intervals)	32 (0dB)			✓
14-01-03	<b>Basic Trunk Data Setup – Receive Level</b> Customize the receive level of the CODEC Gain for each trunk as required.	Trunks 1 ~ 400 1 ~ 57 (-15.5 ~ +12.5dB in 0.5dB intervals)	32 (0dB)			✓
14-01-13	<b>Basic Trunk Data Setup – Trunk-to-Trunk Transfer</b> Enable loop supervision for each Tie Line that should be able to place outgoing calls.	0 = Disable 1 = Enable	1		✓	
14-02-01	<b>Analog Trunk Data Setup – Signaling Type (DP/DTMF)</b> Set the outgoing signaling type for the tie trunk. To set incoming signaling, refer to Program 34-01-02.	0 = Dial Pulse (10 PPS) 1 = Dial Pulse (20 PPS) 2 = DTMF	2			✓
14-05-01	<b>Trunk Group – Trunk Group Number</b> Program Tie Lines of similar type into the same trunk group. The system uses trunk groups for outgoing access to Tie Lines (i.e., Service Code 704 + group). Also see Program 34-05-01.	Trunk Port 1 ~ 400 Group Number 0 ~ 100 Priority 1 ~ 400	Default = Trunks 1 ~ 400 assigned to trunk group 1 with priorities equal to the trunk number. Trunk 1 = Priority 1 Trunk 400 = Priority 400.	✓		
14-06-01	<b>Trunk Group Routing – Priority Order Number</b> Set the priority order number 1 ~ 4.	0 = Not Specify 1 ~ 100: (Trunk Group Number) 101 ~ 150: (100 + Networking System Number) 1001 ~ 1100: (1000 + Route Table Number)	Route 1, Order Number 1 = 1 (Trunk Group 1) Order Numbers 2, 3, 4 = 0 (Not Specified) All Other Routes (2 ~ 100) and Order Numbers (1 ~ 4) = 0 (Not Specified).	✓		

Program Number	Program Name/Description	Input Data	Default	Level		
				1	2	3
20-01-05	<b>System Options – DTMF Receive Active Time</b> After answering the Tie Line call, the system attaches a DTMF receiver to the Tie Line for this time.	0 ~ 64800 seconds	10		✓	
20-06-01	<b>Class of Service for Extensions</b> Assign a Class of Service (1 ~ 15) to extensions.	Day Night/Mode: 1 ~ 8 Class of Service of Extensions (1 ~ 15)	Extension port 101 = Class 15 All other extension port = Class 1	✓		
20-09-01	<b>Class of Service Options (Incoming Call Service) – Second Call for DID/DISA/DIL/E&amp;M Override</b> Turn Off or On the extension ability to receive a second call from a DID, DISA, DIL, or tie line caller.  ➡ <i>With this option set to 1, the destination extension must be busy for a second DNIS caller to ring through. If the destination extension does not have a trunk or CAP key available for the second call and a previous call is ringing the extension but has not yet been answered, the second caller hears busy regardless of this program setting.</i>	0 = Off 1 = On	COS 1 ~ 15 = 1		✓	
20-14-01	<b>Class of Service Options for DISA/E&amp;M – First Digit Absorption (Delete First Digit Dialed)</b> For Tie Lines, turn Off or On the ability to absorb (ignore) the first incoming digit. Use this to make the tie trunk compatible with 3- and 4-digit Tie Line service. This option does not apply to DISA.	0 = Off 1 = On	COS 1 ~ 15 = 0		✓	
20-14-02	<b>Class of Service Options for DISA/E&amp;M – Trunk Group Routing/ARS Access</b> Turn Off or On a DISA or tie trunk caller ability to dial 9 for Trunk Group Routing or Automatic Route Selection (ARS).	0 = Off 1 = On	COS 1 ~ 15 = 1		✓	
20-14-03	<b>Class of Service Options for DISA/E&amp;M – Trunk Group Access</b> Turn Off or On a DISA or tie trunk caller ability to access trunk groups for outside calls (Service Code 704).	0 = Off 1 = On	COS 1 ~ 15 = 1		✓	
20-14-04	<b>Class of Service Options for DISA/E&amp;M – Outgoing System Speed Dial</b> Turn Off or On a DISA or tie trunk caller ability to use the System Speed Dialing.	0 = Off 1 = On	COS 1 ~ 15 = 0		✓	
20-14-05	<b>Class of Service Options for DISA/E&amp;M – Operator Calling</b> Turn Off or On a DISA or tie trunk caller ability to dial 0 for the telephone system operator.	0 = Off 1 = On	COS 1 ~ 15 = 1		✓	

Program Number	Program Name/Description	Input Data	Default	Level		
				1	2	3
20-14-06	<b>Class of Service Options for DISA/E&amp;M – Internal Paging</b> Turn Off or On a DISA or tie trunk caller ability to use the telephone system Internal Paging.	0 = Off 1 = On	COS 1 ~ 15 = 1		✓	
20-14-07	<b>Class of Service Options for DISA/E&amp;M – External Paging</b> Turn Off or On a DISA or tie trunk caller ability to use the telephone system External Paging.	0 = Off 1 = On	COS 1 ~ 15 = 1		✓	
20-14-08	<b>Class of Service Options for DISA/E&amp;M – Direct Trunk Access</b> Turn Off or On a DISA or tie trunk caller ability to use Direct Trunk Access (Service Code 715).	0 = Off 1 = On	COS 1 ~ 15 = 0		✓	
20-14-09	<b>Class of Service Options for DISA/E&amp;M – Forced Trunk Disconnect &lt;Not for ISDN T-point&gt;</b> Turn Off or On a tie trunk caller ability to use Forced Trunk Disconnect (Service Code *26). This option is not available to DISA callers.	0 = Off 1 = On	COS 1 ~ 15 = 0		✓	
20-14-10	<b>Class of Service Options for DISA/E&amp;M – Call Forward Setting by Remote via DISA</b> Turn Off or On a DISA caller ability to use the Call Forward service codes (Program 11-11-01 through Program 11-11-05).	0 = Off 1 = On	COS 1 ~ 15 = 0		✓	
20-14-11	<b>Class of Service Options for DISA/E&amp;M – DISA/Tie Trunk Barge-In</b> Turn Off or On a DISA or tie trunk caller ability to use Barge-In.	0 = Off 1 = On	COS 1 ~ 15 = 0		✓	
20-14-12	<b>Class of Service Options for DISA/E&amp;M – Retrieve Park Hold</b> Turn Off or On a DISA caller ability to retrieve parked or held calls. ➡ <i>Only applies to CCIS trunks.</i>	0 = Off 1 = On	COS 1 ~ 15 = 0		✓	
21-05-01	<b>Toll Restriction Class – International Call Restriction Table</b> For the Toll Restriction Class you select, Assign or Unassign the International Call Restrict Table (Program 21-06-01).	0 = Unassign (No) 1 = Assign (Yes)	1, 6 ~ 15 = 0 2 ~ 5 = 1		✓	
21-05-02	<b>Toll Restriction Class – International Call Permit Code Table</b> For the Toll Restriction Class you select, Assign or Unassign the International Call Permit Table (Program 21-06-02).	0 = Unassign 1 = Assign	1, 3 ~ 15 = 0 2 = 1		✓	
21-05-04	<b>Toll Restriction Class – Maximum Number of Digits Table Assignment</b> Select the table (Program 21-06-03) to be used to determine the maximum number of digits allowed for outgoing calls.	1 ~ 4 = Table 0 = Disable (None)	1, 2, 6 ~ 15 = 0 3 = 1 4 = 2 5 = 3		✓	

Program Number	Program Name/Description	Input Data	Default	Level		
				1	2	3
21-05-05	<b>Toll Restriction Class – Common Permit Code Table</b> Choose whether to refer or not refer to the table set up by Program 21-06-04.	0 = Not Refer 1 = Refer	1, 8 ~ 15 = 0 2 ~ 7 = 1		✓	
21-05-06	<b>Toll Restriction Class – Common Restriction Table</b> Choose whether to refer or not refer to the table set up by Program 21-06-05.	0 = Not Refer 1 = Refer	1, 6 ~ 15 = 0 2 ~ 5 = 1		✓	
21-05-07	<b>Toll Restriction Class – Permit Code Table</b> Set the tables 1 ~ 4 when referring to the table set up by Program 21-06-06.	1 ~ 4 = Table 0 = Disable (None)	1, 2, 6 ~ 15 = 0 3 = 1 4 = 2 5 = 3		✓	
21-05-08	<b>Toll Restriction Class – Restriction Table</b> Set the tables 1 ~ 4 when referring to the table set up by Program 21-06-07.	1 ~ 4 = Table 0 = Disable (None)	1, 2, 6 ~ 15 = 0 3 = 1 4 = 2 5 = 3		✓	
21-05-09	<b>Toll Restriction Class – Restriction for Common Speed Dials</b> For the Code Restriction Class you select, Enable/Disable Code Restriction for Common Speed Dialing numbers.	0 = Disable 1 = Enable	0		✓	
21-05-10	<b>Toll Restriction Class – Restriction for Group Speed Dials</b> For the Toll Restriction Class you select, Enable/Disable Code Restriction for Group Speed Dialing numbers.	0 = Disable 1 = Enable	0		✓	
21-05-11	<b>Toll Restriction Class – Intercom Call Restriction</b> For the Toll Restriction Class you select, Enable/Disable Intercom Call Restriction. If enabled, extensions cannot receive Intercom calls.	0 = Disable 1 = Enable	0		✓	
21-05-12	<b>Toll Restriction Class – PBX Call Restriction</b> Set how the system Toll Restricts calls over PBX trunks. If you enable PBX Toll Restriction, the system begins Toll Restriction after the PBX access code. The user cannot dial a PBX extension. If you disable Toll Restriction, the system only restricts calls that contain the PBX access code, but does not restrict calls to PBX extensions. Refer to PBX compatibility feature.	0 = Disable 1 = Enable	1 ~ 6, 8 ~ 15 = 0 7 = 1		✓	
21-05-13	<b>Toll Restriction Class – Restriction of Tie Line Calls</b> Enable/Disable toll restriction for Tie Line calls (defined in Program 34-08-01).	0 = Disable 1 = Enable	0		✓	

Program Number	Program Name/Description	Input Data	Default	Level		
				1	2	3
22-02-01	<b>Incoming Call Trunk Setup</b> Set the feature type for the trunk you are programming. For each Night Service mode, enter 5 when the trunk should be an E&M tie line.	0 = Normal 1 = VRS (second dial tone if no VRS installed) 2 = DISA 3 = DID 4 = DIL 5 = E&M Tie line 6 = Delayed VRS 7 = ANI/DNIS 8 = DID(DDI) Mode Switching	0		✓	
34-01-01	<b>E&amp;M Tie Line Basic Setup – DID/E&amp;M Start Signaling</b> Set the start signaling mode for DID and Tie trunks. They can use either immediate start or Wink start signaling.	0 = 2nd Dial Tone 1 = Wink (default) 2 = Immediate 3 = Delay	1			✓
34-01-03	<b>E&amp;M Tie Line Basic Setup – E&amp;M Dial-In Mode</b> Determine if the incoming Tie Line call should be directed as an intercom call or if it should follow the DID Translation Table in Program 22-11-01.	0 = Specify Extension Number (Intercom) 1 = Use Conversion Table (NTT)	0			✓
34-01-04	<b>E&amp;M Tie Line Basic Setup – E&amp;M Line Dial Tone</b> Enable if the Tie Line should send dial tone to the calling system after the call is set up. Disable if the Tie Line should not send dial tone.	0 = Disable (No) 1 = Enable (Yes)	1			✓
34-01-05	<b>E&amp;M Tie Line Basic Setup – System Toll Restriction</b> Determine if an incoming Tie Line call should be subject to Toll Restriction.	0 = No (Off) 1 = Yes (On)	0			✓
34-02-01	<b>E&amp;M Tie Line Class of Service</b> Assign the Tie Line Class of Service (1 ~ 15). Use Program 20-14-01 to set the Tie Line Class of Service options. You cannot use Program 20-06 to assign Class of Service to Tie Lines.	Day/Night Mode 1 ~ 8 Class: 1 ~ 15	1			✓
34-03-01	<b>Trunk Group Routing for E&amp;M Tie Lines</b> Assign the trunk group route chosen when a user seizes a Tie Line and dials 9. Set Trunk Group Routing in Program 14-06-01. If the system has ARS, dial 9 to access ARS.	0 ~ 100 (0 = No Setting)	1			✓
34-04-01	<b>E&amp;M Tie Line Toll Restriction Class</b> If the system uses Toll Restriction, enter a Toll Restriction Class (1 ~ 15) for each Tie Line. The system uses the class you enter in Program 21-05 and 21-06. Make a separate Toll Restriction Class entry for each night service mode. You cannot use Program 20-06 to assign Toll Restriction to Tie Lines.	1 ~ 15	2			✓

Program Number	Program Name/Description	Input Data	Default	Level		
				1	2	3
34-05-01	<b>Tie Line Outgoing Call Restriction</b> Build a restriction matrix for outgoing trunk calls placed over a Tie Line. For each Tie Line trunk group, Enable/ Disable outgoing access to each CO trunk group.	0 = Enable (Y-Tandem) 1 = Disable (N-Tandem)	0	✓		
34-06-01	<b>Add/Delete Digit for E&amp;M Tie Line – Delete Digit</b> Some Tie Line networks pass the location number and extension number to the remote side. If the system should ignore these digits, use this program to define the number of digits which should be deleted for a call.	0 ~ 255 (255 = delete all digits)	0		✓	
34-06-02	<b>Add/Delete Digit for E&amp;M Tie Line – Additional Dial Digits</b> If a Tie Line network requires additional digits to reroute the call to a location, enter the digits for the location which should be added to the received digits.	Maximum of four digits (0 ~ 9, *, #)	No Setting		✓	
34-07-01	<b>E&amp;M Tie Line Timer – First Digit Pause (E&amp;M Immediate Start)</b> Define the First Digit Pause (E&M Immediate Start) timer.	0 ~ 64800 seconds	3			✓
34-07-02	<b>E&amp;M Tie Line Timer – First Digit Pause (E&amp;M Wink Start)</b> Define the First Digit Pause (E&M Wink Start) timer.	0 ~ 64800 seconds	0			✓
34-07-03	<b>E&amp;M Tie Line Timer – First Digit Pause (LD Trunk)</b> Define the First Digit Pause (LD Trunk) timer.	0 ~ 64800 seconds	3			✓
34-07-04	<b>E&amp;M Tie Line Timer – LD Trunk Guard Time</b> Define the LD Trunk Guard Time.	0 ~ 64800 seconds	0			✓
34-07-05	<b>E&amp;M Tie Line Timer – Trunk Answer Detect Timer for E&amp;M</b> Define the Trunk Answer Detect Timer for E&M timer.	0 ~ 64800 seconds	30			✓
34-08-01	<b>Toll Restriction Data for E&amp;M Tie Lines</b> Define the toll restriction data for E&M Tie Lines if required. This must be defined if toll restriction is enabled in Program 21-05-13.	Maximum of 10 digits (0 ~ 9, *, #)	No Setting		✓	
80-03-01	<b>DTMF Tone Receiver Setup – Detect Level</b> Use Items 11~32 to set the criteria for dial tone detection for outgoing ARS calls.	0 = 0dBm ~ -25dBm 1 = -5dBm ~ -30dBm 2 = -10dBm ~ -35dBm 3 = -15dBm ~ -40dBm 4 = -20dBm ~ -45dBm 5 = -25dBm ~ -50dBm 6 = -30dBm ~ -55dBm	Type 1 ~ 5 = 0			✓

Program Number	Program Name/Description	Input Data	Default	Level		
				1	2	3
80-03-02	<b>DTMF Tone Receiver Setup – Start Delay Time</b> Define the start delay time for DTMF Tone Receiver.	0 ~ 255 (0.25ms ~ 64ms)	Type 1 ~ 5 = 0			✓
80-03-03	<b>DTMF Tone Receiver Setup – Min. Detect Level</b> Define the minimum detection level for DTMF Tone Receiver.	0 ~ 15 detect level 0: -10dBm(0) to -25dBm(15) detect level 1: -15dBm(0) to -30dBm(15) detect level 2: -20dBm(0) to -35dBm(15) detect level 3: -25dBm(0) to -40dBm(15) detect level 4: -30dBm(0) to -45dBm(15) detect level 5: -35dBm(0) to -50dBm(15) detect level 6: -40dBm(0) to -55dBm(15) detect level 7: -45dBm(0) to -60dBm(15) detect level 8: -50dBm(0) to -65dBm(15) detect level 9: -55dBm(0) to -70dBm(15) detect level 10: -60dBm(0) to -75dBm(15) detect level 11: -65dBm(0) to -80dBm(15) detect level 12: -70dBm(0) to -85dBm(15) detect level 13: -75dBm(0) to -90dBm(15) detect level 14: -80dBm(0) to -95dBm(15) detect level 15: -85dBm(0) to -100dBm(15)	Type 1 = 10 (-20dBm) Type 2 ~ 3 = 15 (-25dBm) Type 4 ~ 5 = 10 (-20dBm)			✓



Program Number	Program Name/Description	Input Data	Default	Level		
				1	2	3
80-03-04	<b>DTMF Tone Receiver Setup – Max. Detect Level</b> Define the maximum detection level for DTMF Tone Receiver.	0 ~ 15 detect level 0: 0dBm(0) to -15dBm(15) detect level 1: -5dBm(0) to -20dBm(15) detect level 2: -10dBm(0) to -25dBm(15) detect level 3: -15dBm(0) to -30dBm(15) detect level 4: -20dBm(0) to -35dBm(15) detect level 5: -25dBm(0) to -40dBm(15) detect level 6: -30dBm(0) to -45dBm(15) detect level 7: -35dBm(0) to -50dBm(15) detect level 8: -40dBm(0) to -55dBm(15) detect level 9: -45dBm(0) to -60dBm(15) detect level 10: -50dBm(0) to -65dBm(15) detect level 11: -55dBm(0) to -70dBm(15) detect level 12: -60dBm(0) to -75dBm(15) detect level 13: -65dBm(0) to -80dBm(15) detect level 14: -70dBm(0) to -85dBm(15) detect level 15: -75dBm(0) to -90dBm(15)	Type 1 ~ 5 = 2 (-2dBm)			✓
80-03-05	<b>DTMF Tone Receiver Setup – Forward Twist Level</b> Define the forward twist level for DTMF Tone Receiver.	0 ~ 9 (1dB ~ 10dB)	Type 1 ~ 5 = 5 (6dBm)			✓
80-03-06	<b>DTMF Tone Receiver Setup – Backwards Twist Level</b> Define the backwards twist level for DTMF Tone Receiver.	0 ~ 9 (1dB ~ 10dB)	Type 1 ~ 5 = 0 (1dBm)			✓

Program Number	Program Name/Description	Input Data	Default	Level		
				1	2	3
80-03-07	<b>DTMF Tone Receiver Setup – ON Detect Time</b> Define the On detection time for DTMF Tone Receiver.	1 ~ 255 (15+ 15ms ~ 3825ms)	<b>Version 1000</b> Type 1 ~ 5 = 1 (30ms)			✓
			<b>Version 3000 or higher</b> Type 1 ~ 5 = 3 (60ms)			
80-03-08	<b>DTMF Tone Receiver Setup – OFF Detect Time</b> Define the Off detection time for DTMF Tone Receiver.	1 ~ 255 (15+ 15ms ~ 3825ms)	<b>Version 1000</b> Type 1 ~ 5 = 1 (30ms)			✓
			<b>Version 3000 or higher</b> Type 1 ~ 5 = 2 (45ms)			
80-04-01	<b>Call Progress Tone Detector Setup – Detection Level</b> Define the detection levels for the Call Progress Tone Detector.	0 = 0dBm ~ -25dBm 1 = -5dBm ~ -30dBm 2 = -10dBm ~ -35dBm 3 = -15dBm ~ -40dBm 4 = -20dBm ~ -45dBm 5 = -25dBm ~ -50dBm 6 = -30dBm ~ -55dBm	Type 1 (DT) – 0 (-25dBm) Type 2 (BT) – 0 (-25dBm) Type 3 (RBT) – 0 (-25dBm) Type 4, Type 5 – 0			✓
80-04-02	<b>Call Progress Tone Detector Setup – Min. Detection Level</b> Define the minimum detection levels for the Call Progress Tone Detector.	0 ~ 15 detect level 0: -15dBm (0) to -30dBm(15) detect level 1: -30dBm (0) to -45dBm(15) detect level 2: -40dBm (0) to -55dBm(15)	<b>Version 1000</b> Type 1 (DT) – 15 (-25dBm) Type 2 (BT) – 15 (-25dBm) Type 3 (RBT) – 15 (-25dBm) Type 4, Type 5 – 0			✓
			<b>Version 3000 or higher</b> Type 1 (DT) – 15 (-25dBm) Type 2 (BT) – 15 (-25dBm) Type 3 (RBT) – 15 (-25dBm) Type 4 – 0 Type 5 – 1			

Program Number	Program Name/Description	Input Data	Default	Level		
				1	2	3
80-04-03	<b>Call Progress Tone Detector Setup – S/N Ratio</b> Define the S/N ratio for the Call Progress Tone Detector.	0 ~ 4 (0dB ~ -20dB)	Type 1 (DT) – 4 (-20dB) Type 2 (BT) – 4 (-20dB) Type 3 (RBT) – 4 (-20dB) Type 4, Type 5 – 0			✓
80-04-04	<b>Call Progress Tone Detector Setup – No Tone Time</b> Define the no tone time for the Call Progress Tone Detector.	0 ~ 255 (30 + 30 ~ 7680ms) (0 = not detect) 1 ~ 255 = 60 ~ 7680ms The formula is 30 + 30N. When set to N = 1, it means 30 + 30 * 1 = 60. When set to N=255, it means 30+30*255=7680	Type 1 (DT) – 132 (3990ms) Type 2 (BT) – 132 (3990ms) Type 3 (RBT) – 132 (3990ms) Type 4, Type 5 – 0			✓
80-04-05	<b>Call Progress Tone Detector Setup – Pulse Count</b> Define the pulse count for the Call Progress Tone Detector.	1 ~ 255	Type 1 (DT) – 1 Type 2 (BT) – 1 Type 3 (RBT) – 1 Type 4, Type 5 – 0			✓
80-04-06	<b>Call Progress Tone Detector Setup – ON Minimum Time</b> Define the on minimum time for the Call Progress Tone Detector.	1 ~ 255 (30 + 30 ~ 7680ms)	<b>Version 1000</b> Type 1 (DT) – 9 (300ms) Type 2 (BT) – 12 (300ms) Type 3 (RBT) – 25 (780ms) Type 4, Type 5 – 0  <b>Version 3000 or higher</b> Type 1 (DT) – 45 (300ms) Type 2 (BT) – 12 (300ms) Type 3 (RBT) – 25 (780ms) Type 4 – 0 Type 5 – 5			✓

Program Number	Program Name/Description	Input Data	Default	Level		
				1	2	3
80-04-07	<b>Call Progress Tone Detector Setup – ON Maximum Time</b> Define the on maximum time for the Call Progress Tone Detector.	0 ~ 255 (30+30-7680ms)	<b>Version 1000</b> Type 1 (DT) – 0 Type 2 (BT) – 20 (630ms) [ET] Type 3 (RBT) – 40 1230ms Type 4, Type 5 – 0			✓
			<b>Version 3000 or higher</b> Type 1 (DT) – 0 Type 2 (BT) – 20 (630ms) [ET] Type 3 (RBT) – 40 1230ms Type 4 – 0 Type 5 – 15			
80-04-08	<b>Call Progress Tone Detector Setup – OFF Minimum Time</b> Define the off minimum time for the Call Progress Tone Detector.	1 ~ 255 (30+30-7680 ms)	Type 1 (DT) – 1 (60ms) Type 2 (BT) – 12 (300 ms) Type 3 (RBT) – 83 (2520ms) Type 4, Type 5 – 0			✓
80-04-09	<b>Call Progress Tone Detector Setup – OFF Maximum Time</b> Define the off maximum time for the Call Progress Tone Detector.	0 ~ 255 (30+30-7680 ms)	Type 1 (DT) – 1 (60ms) Type 2 (BT) – 20 (450ms) Type 3 (RBT) – 115 (3480ms) Type 4, Type 5 – 0			✓

## Operation

None

## Multi-Device Support

### Description

Multi-Device Support splits an incoming call to multiple termination points. This is accomplished by creating a multi-device call group and assigning the group to a pilot extension number. When the pilot extension number receives a call, all of the devices in the group ring simultaneously. Any extension in the call group can answer the incoming call. When the call is answered, all of the extensions in the multi-device call group stop ringing.

If members of the pilot group are talking with one another and an external call is received, the calling party hears a busy tone. The pilot number is displayed on the calling parties caller ID for all members of the group; individual group extension numbers are not sent. It is as if there is only one extension number.

For an example, if you make a Multi-Device Group including the pilot extension "100", the member extensions "101" and "102", when there is an incoming call for the pilot extension "100", all terminals of the group will ring at the same time. Any of the three extensions can be used to answer the incoming call. When the call is answered, all three extensions stop ringing.

A Multi-Device Group key (#14) can be programmed on the pilot and member stations to enable or disable the Group. When enabled, the key is lit and the Multi-Device Group functions. When disabled, the key is not lit and the pilot and members function independently as if they were not in a Multi-Device Group.

Figure 2-66 Multi-Device Group Extension Example

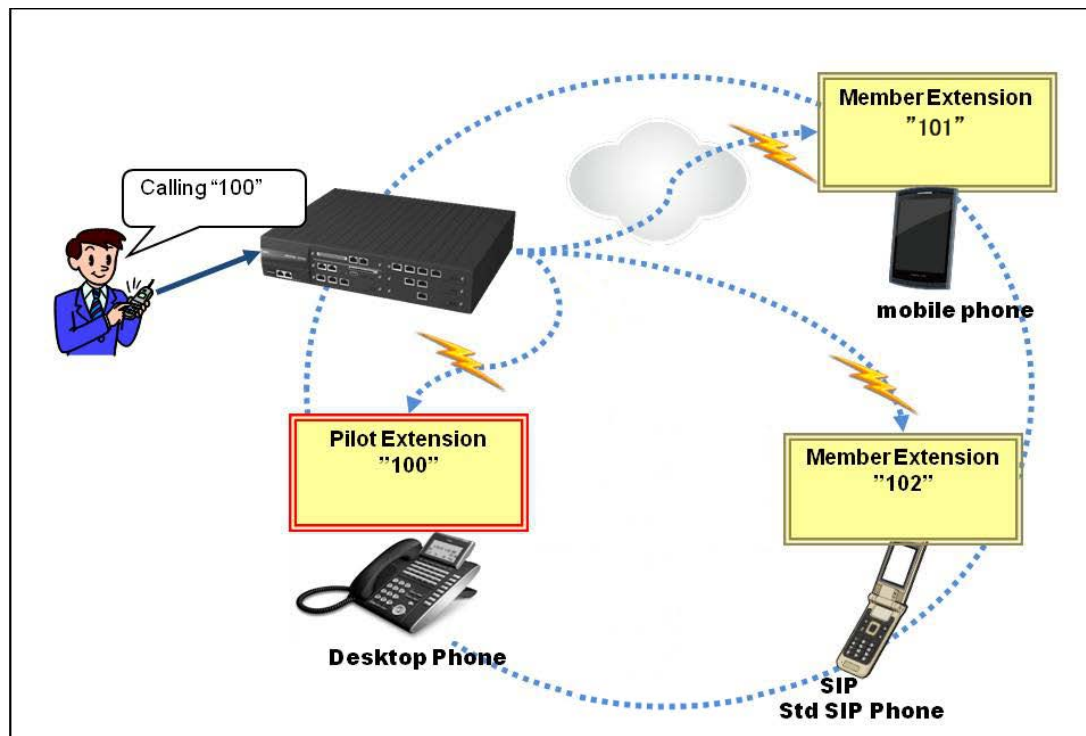

## Multi-Device Group and E911

E-911 Compatibility ensures that emergency calls always get through. If an emergency occurs, a user goes to any telephone, lifts the handset and dials 911.

- ❑ Attendant Notification – The attendant receives a notification each time a co-worker dials an emergency 911 call. This notification is the co-worker’s name and number display optionally accompanied by an audible alarm. Notification occurs regardless of whether the attendant is idle or busy on a call. You can optionally extend this ability to other supervisory extensions as well. Each member of the Multi-Device group will send it’s own name and number display to attendant and not the name and number of Pilot extension. (Refer to [E-911 Compatibility on page 2-504](#) for additional programming.)
- ❑ Emergency Routing – When an Multi-Device Group member dials 911, the system can automatically find a trunk for the call. If another member terminal in the group is in use the other terminals in the group will still be able to dial 911. The system can choose a route to which the user normally does not have access. If all normal routes are busy, the system can even disconnect an active call and place the emergency call. E-911 Compatibility uses the flexibility of the Automatic Route Selection (ARS) Call Route Options to route 911 emergency calls (even in systems in which ARS is not enabled).
- ❑ E911 Outgoing Dialing – The E911 call follows the trunk group route programming. It is possible to use the flexibility of the Automatic Route Selection (ARS) Call Route Options for additional routing options.
- ❑ Forced Disconnect Follows Timer to Disconnect Call – When all lines in the programmed route are busy and the system must drop a call to place a 911 call, the system waits the time set in Program 81-01 before disconnecting the call.
- ❑ Calling Party Identification – With ISDN or SIP Trunks installed, the system can provide the Calling Party Number (CPN) Presentation from Station. No additional customer-provided 911 equipment is required. Each member of the Multi-Device Group will send it’s own Calling Party Number Programmed in 21-13 for ISDN and 21-19 for SIP Trunks.

### Enhancements

- With **Version 4000 (4.00 or higher)** you can have multiple extensions ring when dialing a single extension number. Version 4000 (0414) Enhancement license and Mult-Device-01 (0049) licenses are required.
- With **Version 6000 or higher**, the Multi-Device Group (MDG) state may change when the night mode is changed. MDG state is changed automatically.

### Conditions

- When any Multi-Device Group pilot number is defined in Program 20-63-01, peer-to-peer calls are disabled for all SIP Terminals (DT800/DT700, Standard SIP) system wide.
- When a Member or Pilot extension of the Multi-Device Group is busy, all members of the group will still be able to make Emergency calls to 911.
- Virtual Extensions are not supported as Pilots or Members of a Multi-Device Group.

- When a member of the Multi-Device Group makes a 911 call, the Multi-Device key is disabled and they will be removed from the group until the Multi-Device Key (#14) is enabled again or the Multi-Device Support (On) service code is used (11-11-75: 788).
- The Multi-Device Group key can be programmed, enabled and disabled on Pilot or Member stations.
- When disabling all numbers in a Multi-Device Group using UC Suite, the MDG key programmed on the pilot extension will stay lit. The MDG key on member extensions will go out until the group is enabled again.
- The Multi-Device Support (On)/(Off) service codes (11-11-75 and 11-11-76) can be used from Pilot or Member stations.
- When a Multi Device Group is enabled, the Multi-Device Group key is lit solid red.
- When a Multi Device Group is disabled, the Multi-Device Group key is not lit.
- Receiving Internal Pages is not supported on the Pilot or Member Extension of the Multi-Device Group.
- Each Pilot and Member of the Multi-Device Group controls it's own SMDR.
- BLF of Pilot Extension number replaces the BLF of each Multi-Device Group Member.
- When a Member Extension is assigned to Multi-Device Group all Call Forwarding settings are canceled.
- Call Forwarding is not supported on Multi-Device Group members, but is supported on the Pilot extension.
- Second Call, Call Waiting, and Call Queuing is not supported on Multi-Device Group Member or Pilot extension.
- Call Forward Follow Me is not supported on Multi-Device Group Member or Pilot extension.
- Call Forward Both Ring is not supported on Multi-Device Group Member or Pilot extension.
- Calling between Members and Pilot extension is not supported.
- Pilot or Member extension cannot be a Contact Center Agent or a member of Department Group.
- Message Waiting Indication is not supported on Multi-Device Group Member.
- Peer to Peer calls of SIP Terminals (DT800/DT700, Standard SIP) is not supported.
- Ring Group calls will only flash line key and not audibly ring, line key must be pressed to answer.
- When using the Conversation Record feature, recordings are sent to the Pilot extensions Voice Mail box.
- Voice Over and Reverse Voice Over is not supported.
- In order for a mobile phone to ring you must program a Mobile Extension Port and assign a speed dial bin to that port which has the mobile phone number in it. (Refer to [Mobile Extension on page 2-1133](#) for additional programming.)

- The Pilot extension and Member extension can both be assigned to a Multi-Device Group using the User Admin mode (UA Mode).
- When logging as User Mode (UB Mode), only the Member extension can be assigned to a Multi-Device Group.
- When Logging as User Mode (UB Mode), if the Pilot extension is not assigned in Program 20-63-01 an error is displayed when the user clicks on Multi-Device Group setup.
- When logging as User Mode (UB mode), an error is displayed on the Multi-Device Group setup screen if the user tries to save the Member extension number by clicking on "Apply" button after deleting Program 20-63-01.
- When logging as User Mode (UB mode), an error is displayed on the Multi-Device Group setup screen if user clicks on "Refresh" button after deleting Program 20-63-01.
- Duplicate extensions cannot be assigned within the same or different Multi-Device Group. An error is displayed if the user tries to assign the duplicate extension.
- When a station in a Multi-Device group is busy, only the BLF for the active station will show busy. Not all stations in the Multi-Device Group show busy.
- If internal extensions or mobile extensions are added to the Multi-Device Group via system programming using Program 20-63, the UC Client must be restarted to apply these changes.
- The number of external numbers available in the Multi-Device Group is directly related to the number of Mobile Extensions defined in the group (Program 20-63). If the user requires additional external numbers, more mobile extensions need to also be added to the group using Program 20-63. UC Suite must be restarted for these changes to take effect.
- When a UC Client is configured with the Softphone+Deskset license level in Program 20-59-14, the UC Client will always use the Deskset extension to search for a matching Multi-Device Pilot.
- If DND or CFA is set for the Pilot or any member of the Multi-Device Group, only the station that is set will show DND or CFA in the UC Suite BLF view, not each member in the group.
- The maximum number of Multi-Device Groups is 256.
- Each Multi-Device Group can consist of one pilot and a maximum of seven additional devices.
- With Version 6000 or higher, to enable this function, it is necessary to enable the Program 20-63-09.
- With Version 6000 or higher, if Program 20-63-09 is disabled, the MDG state will not change at the same time as night mode changes.
- With Version 6000 or higher, when night mode is changed manually, the MDG state is changed. The "Night Mode Group" extension assigned in Program 12-05-01 which perform night mode toggle operations should be the same as assigned in Program 20-68-01.
- With Version 6000 or higher, the MDG state is changed when Night Mode is changed automatically.



- With Version 6000 or higher, the MDG State will not be changed with Automatic Mode Switching, if Night Mode is changed manually before restarting the system and the Automatic Night Mode Switching time comes in between system restart.
- With Version 6000 or higher, the MDG State is changed with Automatic Mode Switching, if Night Mode is changed automatically before restarting the system and the Automatic Night Mode Switching time comes in between system restart.
- With Version 6000 or higher, the MDG State is changed if Night Mode is switched automatically after changing the night mode manually before restarting the system and the Automatic Night Mode Switching time comes in between system restart.
- With Version 6000 or higher, the MDG state will not be changed by function key (#14) or by service code while system is applying the changes as per Program 20-63.
- With Version 6000 or higher, the MDG state will not be changed while system is applying the changes as per Program 20-63, when Night mode is switched automatically.
- With Version 6000 or higher, the “Night Mode Group” defined in Program 12-05-01 for the extension which belongs to a MDG is applied irrespective of MDG state.

Table 2-89 Supported System Feature List

Feature	Pilot	Member	Comment
Abbreviated Dialing/Speed Dial	Yes	Yes	
Account Code Entry	Yes	Yes	
Account Code - Forced/Verified/Unverified	Yes	Yes	
Alarm	No	No	
Alarm Reports	No	No	
Alphanumeric Display	Yes	Yes	
Analog Communications Interface (ACI)	No	No	
Ancillary Device Connection	No	No	
Answer Hold	No	No	
Answer Key	Yes	Yes	
Applications	No	No	
Attendant Call Queuing	No	No	
Automatic Release	Yes	Yes	
Automatic Route Selection (ARS)	Yes	Yes	
Background Music	Yes	Yes	
Barge-In	No	No	
Call Appearance (CAP) Keys	Yes	Yes	
Call Duration Timer	Yes	Yes	

Table 2-89 Supported System Feature List (Continued)

Feature	Pilot	Member	Comment
Call Forwarding	Yes	No	Call Forwarding All, Busy No Answer, Busy, and No Answer can be assigned to Pilot Number. If any Forwarding is assigned to a member it is canceled and not followed.
Call Forwarding with Follow Me	No	No	
Call Forwarding, Off-Premise	Yes	No	
Call Forwarding/Do Not Disturb Override	Yes	No	
Call Monitoring	No	No	
Call Redirect	Yes	Yes	
Callback	No	No	
Caller ID Caller Return	Yes	Yes	
Caller ID	Yes	Yes	
Call Waiting/Camp-On	No	No	
Central Office Calls, Answering	Yes	Yes	
Central Office Calls, Placing	Yes	Yes	
Class of Service	Yes	Yes	
Clock/Calendar Display	Yes	Yes	
Code Restriction	Yes	Yes	
Code Restriction Override	Yes	Yes	
Code Restriction, Dial Block	Yes	Yes	
Computer Telephony Integration (CTI) Applications	No	No	
Conference Calls	Yes	Yes	Only one terminal from Multi-Device Group can be in conference.
Conference, Voice Call/Privacy Release	Yes	No	
Contact Center	No	No	
Cordless Telephone Connection	Yes	Yes	
CO Message Waiting Indication	Yes	Yes	
Data Line Security	No	No	
Delayed Ringing	Yes	Yes	Regardless of setting in Program 15-09, VE will only flash and not audibly ring. VE key must be pressed in order to answer.
Department Calling	No	No	
Department Step Calling	No	No	
Dialing Number Preview	Yes	Yes	
Dial Pad Confirmation Tone	Yes	Yes	
Dial Tone Detection	Yes	Yes	
Directed Call Pickup	Yes	Yes	
Directory Dialing	Yes	Yes	

Table 2-89 Supported System Feature List (Continued)

Feature	Pilot	Member	Comment
Direct Inward Dialing (DID)	Yes	Yes	
Direct Inward Line (DIL)	Yes	Yes	
Direct Inward System Access (DISA)	Yes	Yes	
Direct Station Selection (DSS) Console	No	No	
Distinctive Ringing, Tones and Flash Patterns	Yes	Yes	
Door Box	No	No	
Do Not Disturb	Yes	Yes	When DND is activated on the Multi-Device Group Pilot the entire Multi-Device Group group is put in DND when Pilot number is dialed.
Drop Key	Yes	Yes	
E911/911	Yes	Yes	On 911 calls the Calling Party Number assigned in Program 21-13 and 21-19 is sent for each member of Multi-Device Group. Attendant Notification name and number is sent from each Multi-Device Group Member.
Flash	Yes	Yes	
Flexible System Numbering	Yes	Yes	
Flexible Timeouts	Yes	Yes	
Forced Trunk Disconnect	Yes	Yes	
Group Call Pickup	Yes	Yes	Cannot perform call Pickup for specific group. Only system wide or extension specific Call Pickup is supported.
Group Listen	Yes	Yes	
Hands Free	Yes	Yes	
Handset Mute	Yes	Yes	
Handset Name	Yes	Yes	
Handsfree Answerback/Forced Intercom	No	No	
Headset Operation	Yes	Yes	
Hold	Yes	Yes	
Hotel/Motel	No	No	
Hotline	Yes	Yes	
Howler Tone Service	Yes	Yes	
Instant Access Application (IAA)	Yes	Yes	
Intercom	Yes	Yes	
IP Multiline Station (SIP)	Yes	Yes	
IP Multiline Station (SIP) – ML440 Cordless	Yes	Yes	
IP Multiline Telephone	Yes	Yes	

Table 2-89 Supported System Feature List (Continued)

Feature	Pilot	Member	Comment
IP Single Line Telephone (SIP)	Yes	Yes	
IP Single Line Telephone (SIP) – NAT Mode	Yes	Yes	
IP Trunk – H.323	Yes	Yes	
IP Trunk – (SIP) Session Initiation Protocol	Yes	Yes	Calling Party Number assigned in Program 21-19 for the Multi-Device Group Pilot is sent for each member of Multi-Device Group. On 911 calls the Calling Party Number assigned in Program 21-19 is sent for each member of Multi-Device Group.
IP Video Doorphone	No	No	
ISDN Compatibility	Yes	Yes	Calling Party Number assigned in Program 21-13 for the Multi-Device Group Pilot is sent for each member of Multi-Device Group. On 911 calls the Calling Party Number assigned in Program 21-13 is sent for each member of Multi-Device Group.
IVR – Appointment Reminder Server	Yes	Yes	
IVR – Broadcast Server	Yes	Yes	
K-CCIS – IP	No	No	Pilot Calls across IP CCIS are not supported.
K-CCIS - T1	No	No	Pilot Calls across T1 CCIS are not supported.
Last Number Redial	Yes	Yes	
Line Preference	Yes	Yes	
Long Conversation Cutoff	Yes	Yes	
Meet Me Conference	Yes	Yes	Multi-Device Group members and Pilot can initiate and may join Meet Me Conference by dialing internal page zone, but will not receive the page.
Meet Me Paging	Yes	Yes	Multi-Device Group members and Pilot can initiate and may join Meet Me Page by dialing internal page zone, but will not receive the internal page.
Meet Me Paging Transfer	Yes	Yes	Multi-Device Group members and Pilot can initiate and may receive the transfer by dialing internal page zone, but will not receive the internal page.
Memo Dial	Yes	Yes	
Message Waiting Indication (MWI)	Yes	No	
Microphone Cutoff	Yes	Yes	
Mobile Extension	Yes	Yes	
Multiple Trunk Types	Yes	Yes	
Music on Hold	Yes	Yes	
Name Storing	Yes	No	
NetLink	Yes	Yes	

Table 2-89 Supported System Feature List (Continued)

Feature	Pilot	Member	Comment
Night Service	Yes	Yes	
Off-Hook Signaling	No	No	
Off-Premise Extension	No	No	
One-Touch Calling	Yes	Yes	
Operator	No	No	
Paging, External	Yes	Yes	A Multi-Device Group Pilot and Member can only initiate an External or All Call Page. It cannot receive either Internal or All Call pages or display page information.
Paging, Internal	Yes	Yes	A Multi-Device Group Pilot and Member can only initiate an Internal or All Call Page. It cannot receive either Internal or All Call pages or display page information.
Park	Yes	Yes	
PBX Compatibility	Yes	Yes	
PC Programming	Yes	Yes	
Personal Park	Yes	Yes	
Power Failure Transfer	Yes	Yes	
Prime Line Selection	Yes	Yes	
Private Line	Yes	Yes	
Programmable Function Keys	Yes	Yes	
Programming from a Multiline Terminal	Yes	Yes	
Pulse to Tone Conversion	No	No	
Quick Transfer to Voice Mail	Yes	No	Quick Transfer to Voice Mail is not supported to supported to Multi-Device Group, only to the Pilot extension.
Repeat Redial	Yes	Yes	
Reverse Voice Over	No	No	
Ringdown Extension, Internal/External	Yes	Yes	
Ring Groups	No	No	All Terminals of the Multi-Device group can answer incoming Ring Group calls by pressing Line Key, but will not audibly ring.
Room Monitor	No	No	
Save Number Dialed	Yes	Yes	
Secondary Incoming Extension	Yes	Yes	Regardless of setting in Program 15-09, VE will only flash and not audibly ring. VE key must be pressed in order to answer.
Secretary Call Pickup	No	No	
Secretary Call (Buzzer)	No	No	

Table 2-89 Supported System Feature List (Continued)

Feature	Pilot	Member	Comment
Selectable Display Messaging	Yes	Yes	
Selectable Ring Tones	Yes	Yes	
Serial Call	No	No	
Simple MCU Video	No	No	
Single Line Telephones, Analog 500/2500 Sets	Yes	Yes	
SLT Adapter	No	No	
Softkeys	No	No	
Station Hunt	No	No	
Station Message Detail Recording	Yes	Yes	Each Member of Group controls it's own SMDR.
Station Name Assignment – User Programmable	Yes	Yes	
Station Relocation	No	No	
SV9100 Communications Analyst	Yes	Yes	Each Member of Group controls it's own SMDR.
SV9100 NetLink	Yes	Yes	
Synchronous Ringing	No	No	
T1 Trunking (with ANI/DNIS Compatibility)	Yes	Yes	
Tandem Ringing	No	No	
Tandem Trunking (Unsupervised Conference)	Yes	Yes	A member of MDG can initiate an unsupervised conference. Multiple members of MDG can not be in conference.
TAPI Compatibility	No	No	
Tone Override	No	No	
Transfer	Yes	Yes	Unsupervised Transfer to Multi Device Group Members is not supported.
Trunk Groups	Yes	Yes	
Trunk Group Routing	Yes	Yes	
Trunk Queuing/Camp-On	No	No	
UC Suite	Yes	Yes	
Uniform Call Distribution (UCD)	No	No	
User Programming Ability	Yes	Yes	
Video Call	No	No	
Virtual Extensions	Yes	Yes	Regardless of setting in Program 15-09, VE will only flash and not audibly ring. VE key must be pressed in order to answer.
VM8000 InMail	Yes	Yes	When the VMsg softkey is pressed on a Multi Device Member they are logged into the Pilots mailbox. MWI is not supported to Multi Device Members, however an In-skin Voice Mail key (77) can be used for indication.

Table 2-89 Supported System Feature List (Continued)

Feature	Pilot	Member	Comment
Voice Mail Integration (Analog)	Yes	Yes	
Voice Over	No	No	
Voice Over Internet Protocol (VoIP)	Yes	Yes	
Voice Response System (VRS)	Yes	Yes	
Voice Response System (VRS) – Call Forwarding – Park and Page	No	No	
Volume Controls	Yes	Yes	

### Default Settings

Disabled

### System Availability

#### Terminals

DT300/DT400

DT700/DT800

UT880

Single Line Terminals (SLT)

Standard SIP Terminal (IP-DECT)

ML440

#### Required Component(s)

- GCD-CP10
- 0414 – SV9100 Version Lic (R4)
- 0416 – SV9100 Version Lic (R6)



NOTE

*Only needed if Multi-Device Group (MGD) state change is required.*

- 0300 – SV9100 Resource Lic

- 5201 – SV9100 Mobile Ext Lic



*Only needed if a Mobile Extension Port is required to ring a mobile phone.*

- 0049 – SV9100 Multi-Device



*The number of Multi-Device Groups that can be programmed depends on the number of Multi-Device Licenses (0049) loaded to the CPU. For example, if five Multi-Device Licenses are loaded you could program Multi-Device Group 1-5 in Program 20-63.*

## Related Features

- ➔ [Central Office Calls, Answering](#)
- ➔ [Central Office Calls, Placing](#)
- ➔ [E-911 Compatibility](#)
- ➔ [Intercom](#)
- ➔ [Mobile Extension](#)
- ➔ [Night Service](#)

## Guide to Feature Programming

The **Level 1**, **Level 2** and **Level 3** columns indicate the programs that are assigned when programming this feature in the order they are most commonly used. These levels are used with PCPro and WebPro wizards for feature programming.

- Level 1 – these are the most commonly assigned programs for this feature.
- Level 2 – these are the next most commonly assigned programs for this feature.
- Level 3 – these programs are not often assigned and require an expert level working knowledge of the system to be properly assigned.

Program Number	Program Name/Description	Input Data	Default	Level		
				1	2	3
11-11-75	<b>Service Code Setup (for Setup/Entry Operation) – Multi-Device Support (On)</b> Used to enable the Multi-Device group key.	MLT	788	✓		
11-11-76	<b>Service Code Setup (for Setup/Entry Operation) – Multi-Device Support (Off)</b> Used to disable the Multi-Device group key.	MLT	789	✓		



Program Number	Program Name/Description	Input Data	Default	Level		
				1	2	3
20-63-01	<b>Multi-Device Group Setup – Pilot Extension Number</b> Used to assign the pilot group extension number.	Maximum of eight digits (Group 1 ~ 256)	No Setting	✓		
20-63-02	<b>Multi-Device Group Setup – Member Extension Number 1</b> Used to assign the first extension number in the call group.	Maximum of eight digits (Group 1 ~ 256)	No Setting	✓		
20-63-03	<b>Multi-Device Group Setup – Member Extension Number 2</b> Used to assign the second extension number in the call group.	Maximum of eight digits (Group 1 ~ 256)	No Setting	✓		
20-63-04	<b>Multi-Device Group Setup – Member Extension Number 3</b> Used to assign the third extension number in the call group.	Maximum of eight digits (Group 1 ~ 256)	No Setting	✓		
20-63-05	<b>Multi-Device Group Setup – Member Extension Number 4</b> Used to assign the fourth extension number in the call group.	Maximum of eight digits (Group 1 ~ 256)	No Setting	✓		
20-63-06	<b>Multi-Device Group Setup – Member Extension Number 5</b> Used to assign the fifth extension number in the call group.	Maximum of eight digits (Group 1 ~ 256)	No Setting	✓		
20-63-07	<b>Multi-Device Group Setup – Member Extension Number 6</b> Used to assign the sixth extension number in the call group.	Maximum of eight digits (Group 1 ~ 256)	No Setting	✓		
20-63-08	<b>Multi-Device Group Setup – Member Extension Number 7</b> Used to assign the seventh extension number in the call group.	Maximum of eight digits (Group 1 ~ 256)	No Setting	✓		
90-38-37	<b>User Programming Data Level Setup – Multi-Device Group Setup</b> Enable/Disable the Multi-Device Group setup in UserPro.	0 = Off 1 = On	1		✓	

**Multi-Device Group State Change:**

Program Number	Program Name/Description	Input Data	Default	Level		
				1	2	3
12-01-01	<b>Night Mode Function Setup – Manual Night Mode Switching</b> Turn Off or On an extension user ability to activate Manual Night Service.	0 = Off 1 = On	1	✓		

Program Number	Program Name/Description	Input Data	Default	Level		
				1	2	3
12-01-02	<p><b>Night Mode Function Setup – Automatic Night Mode Switching</b></p> <p>According to a preset schedule, Enable (1) or Disable (0) Automatic Night Service for the system. Make sure to set the Service Patterns in Program 12-02-01, Program 12-02-02 and Program 12-02-03.</p>	<p>0 = Off 1 = On</p>	0	✓		
12-05-01	<p><b>Night Mode Group Assignment for Extensions</b></p> <p>Assign a Day/Night Mode Group (01 ~ 32), for each extension.</p>	<p>Night Mode Service Group Number: 01 ~ 32</p>	1	✓		
20-07-01	<p><b>Class of Service Options (Administrator Level) – Manual Night Service Enabled</b></p> <p>Turn Off or On an extension user ability to manually Switch the Night Mode (Service Code 718). This option must be enabled for an extension to display the Night indication.</p>	<p>0 = Off 1 = On</p>	<p>COS 1 ~ 14 = 0 COS 15 = 1</p>		✓	
20-63-09	<p><b>Multi-Device Group Setup – Multi-Device - Night Mode Group</b></p> <p>Turn On or Off the MDG state change when Night mode is changed. This program must be set to 1 (On) to change the MDG state.</p>	<p>0 = Off 1 = On</p>	0	✓		
20-68-01	<p><b>Multi-Device Group Assignment for Multi-Device Group – Night Mode Group</b></p> <p>Assign Day/Night mode group for MDG.</p>	<p>Night Mode Service Group Number: 01 ~ 32</p>	1	✓		
20-69-01	<p><b>Multi-Device Group Setup by Night Mode</b></p> <p>On = When changing to night mode is changed, MDG becomes login. Off = When night mode is changed, MDG becomes Logout.</p> <p>➡ <i>When accessing 3-digit MDG (i.e., 099) from TelPro, mode selection setting will be skipped and cursor will go directly to MD Assign setting.</i></p>	Day/Night Mode: 1 ~ 8	1	✓		

## Operation

### To Enable Multi-Device Group:

1. Press the Multi-Device Group key (752:#14).

◇ *The Multi-Device Group key will light solid red.*

**- OR -**

Press the Speaker Key or lift the Hand Set and dial the Multi-Device Support (ON) service code, 788 by default.

◇ *The Multi-Device Group key will light red and the display will show MDG >> Pilot to MDG >> Member.*

### To Disable Multi-Device Group:

1. Press the Multi-Device Group key (752:#14).

◇ *The Multi-Device Group key will go out.*

**- OR -**

Press the Speaker Key or lift the Hand Set and dial the Multi-Device Support (Off) service code, 789 by default.

◇ *The Multi-Device Group key go out and the display will look like a non-MDG member terminal.*

## Music on Hold

### Description

Music on Hold (MOH) sends music to calls on Hold and parked calls. The music lets the caller know that the call is waiting, not forgotten. Without Music on Hold, the system provides silence to these types of calls. The Music on Hold source can be internal (tone) or from an external customer-provided music source (i.e., tape deck, receiver, etc.). The customer-provided source can connect to a PGD(2)-U10 ADP analog port or to a connector on the GCD-CP10.

### Option Available for Using System Tone

The Music on Hold feature has been enhanced to allow callers to hear a system tone instead of playing the internal or external music.



CAUTION

*In accordance with U.S. copyright law, a license may be required from the American Society of Composers, Authors and Publishers (ASCAP) or other similar organizations, if radio, television broadcasts or music other than material not in the public domain are transmitted through the Music on Hold feature of telecommunications systems. NEC America, NEC Unified Solutions, Inc., and NEC hereby disclaim any liability arising out of the failure to obtain such a license.*

### Conditions

- A maximum of 97 Music on Hold sources are possible; 96 from PGD(2)-U10 ports and one from the connector on the GCD-CP10.
- External music on hold source for internal calls is provided only via audio input on the GCD-CP10. Program 10-04-01 is to be set for 1 = External Source.
- No music is provided to internal calls on hold via the ACI input.
- Use the combination of Program 10-04, Program 10-21, Program 10-38 and Program 14-08.
- The PGD(2)-U10 ADP can connect to a GCD-8DLCA, GCD-16DLCA, or GCD-LTA.



NOTE

*A maximum of 56 PGD(2)-U10 ADP units can be installed in an UNIVERGE SV9100 system.*



REFERENCE

*Refer to the UNIVERGE SV9100 System Hardware Manual for more information.*

- Can only support one Music on Hold source.
- When Program 10-04-01 is set to **Internal**, the SV9100 will not receive Music On Hold from the CPU. IP Terminals music source will come from a locally provided source file (download) based on the setting in Program 10-40-02 (option 1, 2, or 3).

- When Program 10-04-01 is set to **External**, the SV9100 uses an outside source for Music On Hold. IP Terminals music source will come from a locally provided external Music On Hold Source.

### Default Settings

Disabled

## System Availability

### Terminals

None

### Required Component(s)

- Optional – PGD(2)-U10 ADP
- Optional – Locally provided Background Music source (i.e., CD player, Radio, NEC Audio Emcee).

## Related Features

None

## Guide to Feature Programming

The **Level 1**, **Level 2** and **Level 3** columns indicate the programs that are assigned when programming this feature in the order they are most commonly used. These levels are used with PCPro and WebPro wizards for feature programming.

- Level 1 – these are the most commonly assigned programs for this feature.
- Level 2 – these are the next most commonly assigned programs for this feature.
- Level 3 – these programs are not often assigned and require an expert level working knowledge of the system to be properly assigned.

Program Number	Program Name/Description	Input Data	Default	Level		
				1	2	3
10-04-01	<b>Music on Hold Setup – Music on Hold Source Selection</b> Determine whether the system should use Internal MOH, External MOH, Service Tone, or VMDB. If set to 1, Program 14-08-01 must be set to 0 or 1.	0 = Internal MOH 1 = External MOH 2 = Service Tone 3 = VMDB	2	✓		

Program Number	Program Name/Description	Input Data	Default	Level		
				1	2	3
10-04-02	<b>Music on Hold Setup – Music on Hold Tone Selection</b> When Program 10-04-01 is set to Internal MOH, define the music that is played for Music on Hold.	[When Item 1 is 0] 1 = Download File1 2 = Download File2 3 = Download File3 [When Item 1 is 1, 2, or 3] 1 ~ 100 = VRS Message Number	No Setting		✓	
10-04-03	<b>Music on Hold Setup – Audio Gain Setup</b> Set the Music on Hold audio gain (1 ~ 63).	1 ~ 63 (-15.5 +15.5dB)	32 (0dB)		✓	
10-21-04	<b>GCD-CP10 Hardware Setup – External Source I/O Selection on GCD-CP10</b> Define how the I/O ports on the GCD-CP10 are used.	0 = External MOH (AUX2)/ External Speaker(AUX1) 1 = BGM source (AUX2)/ External Speaker(AUX1) 2 = External MOH (AUX2)/ BGM source (AUX1) ➤ Relationships between AUX number and Relay number are as follows: AUX2 = Relay2 AUX1 = Relay1	1		✓	
14-08-01	<b>Music on Hold Source for Trunks – MOH Type</b> Set the Music on Hold source for each trunk.	0 = Internal/External MOH 1 = Customer Provided Source Connected to BGM Port 2 = Customer Provided Source Connected to ACI Port	0	✓		
14-08-02	<b>Music on Hold Source Port Number – Source Port Number</b> If the MOH type is 2 in Program 14-08-01, for each trunk enter the ACI source port number (1 ~ 96).	Source port 0 ~ 96	0	✓		
20-06-01	<b>Class of Service for Extensions</b> Assign a Class of Service (1 ~ 15) to an extension.	Day Night/Mode: 1 ~ 8 Class of Service of Extensions (1 ~ 15)	Extension port 101 = Class 15 All other extension port = Class 1		✓	
20-07-02	<b>Class of Service Options (Administrator Level) – Changing the Music on Hold Tone</b> Turn Off or On an extension user ability to change the Music on Hold tone.	0 = Off 1 = On	COS 1 ~ 14 = 0 COS 1 ~ 15 = 1		✓	
22-11-09	<b>DID Translation Number Conversion – Music On Hold Source</b> For each DID Translation Table entry (1 ~ 4000), specify the source of music to be used for DID trunks.	0 = IC/MOH Port 1 = BGM Port 2 = ACI Port	0		✓	

Program Number	Program Name/Description	Input Data	Default	Level		
				1	2	3
22-11-10	<b>DID Translation Number Conversion – ACI Music Source Port</b> For each DID Translation Table entry (1 ~ 4000), if item 2 is selected in Program 22-11-09, specify the port to be used for the source of music heard on DID trunks.	When a sound source type is 2 in above: (0 ~ 96)	0		✓	
80-01-01	<b>Service Tone Setup – Music On Hold Tone (Service Tone 64)</b> Customize the repeat count for the music on hold tone if Program 10-04-01 is set to 2.	0 ~ 255 (0 = Until On-Hook)	0 Refer to <a href="#">Table 2-33 Service Tone Setup Defaults, Program 80-01-01 on page 2-594</a>			✓
80-01-02	<b>Basic Tone Number</b> Customize the basic tone number for the music on hold tone if Program 10-04-01 is set to 2.	0 ~ 33 (0 = No Tone) (33 = Default Time Slot)	33 = Default Time Slot		✓	
80-01-03	<b>Duration Count</b> Customize the duration count for the music on hold tone if Program 10-04-01 is set to 2.	0 ~ 255 (100 ~ 25500ms)			✓	
80-01-04	<b>Gain Level (dB)</b> Customize the Gain Level for the music on hold tone if Program 10-04-01 is set to 2.	0 ~ 57 (-15.5 ~ +12.5)			✓	

**When Using a PGD(2)-U10 ADP:**

Program Number	Program Name/Description	Input Data	Default	Level		
				1	2	3
10-03-01	<b>ETU Setup (DLCA PKG Setup) – Terminal Type (B1)</b> If a PGD(2)-U10 ADP is used for the external music source, the module is automatically assigned type 9 if the jumper straps in the module were set prior to connecting it to the system. If another type was assigned, disconnect the PGD(2)-U10 ADP from the system, delete the type setting, and, with the jumper straps positioned correctly in the PGD(2)-U10 ADP, reconnect the module to the system. Refer to the UNIVERGE SV9100 System Hardware Manual for the jumper strap settings.	0 = Not set 1 = Multiline Terminal 3 = Bluetooth Cordless Handset 6 = PGD (Paging) 7 = PGD (Tone Ringer) 8 = PGD (Doorbox) 9 = PGD (ACI) 10 = DSS Console 11 = -- Not Used --	0		✓	
11-06-01	<b>ACI Extension Numbering</b> Each ACI port must be assigned an extension number. Assign the extension numbers to ACI software ports. Select a number outside of the normal extension number range.	Maximum of eight digits. ACI Ports: 1 ~ 96	No Setting	✓		

Program Number	Program Name/Description	Input Data	Default	Level		
				1	2	3
11-08-01	<b>ACI Group Pilot Number</b> Assign pilot numbers to ACI groups. When a user dials the pilot number, they reach an available ACI software port within the group.	Dial (maximum of eight digits). ACI Groups 1 ~ 16	No Setting	✓		
22-11-09	<b>DID Translation Number Conversion – Music On Hold Source</b> For each DID Translation Table entry (1 ~ 4000), specify the source of music to be used for DID trunks.	0 = IC/MOH Port 1 = BGM Port 2 = ACI Port	0		✓	
33-01-01	<b>ACI Port Type Setup</b> Set each ACI software port for Input or Input/Output. Use input ports for Music on Hold sources. Use output ports for External Paging/Ringer Control.	ACI Ports: 1 ~ 96 ACI Types: 0 = None 1 = MOH/BGM (Input) 2 = External Audio Port (Input/Output)	2	✓		
33-02-01	<b>ACI Department Calling Group</b> Assign ACI software ports to an ACI Department Group. This lets ACI callers connect to ACI software ports by dialing the group pilot number (set in Program 11-08).	ACI Ports: 1 ~ 96 ACI Groups: 1 ~ 16	ACI Port/Group/ Priority 01/ 1/ 1 02/ 1/ 2 : / : / : 96/ 1/ 96 Refer to <a href="#">Analog Communications Interface (ACI) on page 2-40</a> for additional information.	✓		
80-01-02	<b>Service Tone Setup – Basic Tone Number</b> The following features require that the system tones listed below be changed to match the table. After changing these settings the chassis must be reset for the changes to take effect. <ul style="list-style-type: none"><li>○ Call Screening</li><li>○ Call Holding</li><li>○ Busy Greeting</li><li>○ Await Answer Transfer</li></ul>	1 ~ 33 (0 = No Tone) (33 = Default Time Slot)	33 = Default Time Slot Refer to <a href="#">Table 2-34 Service Tone Setup, Program 80-01-02 on page 2-598</a> .	✓		



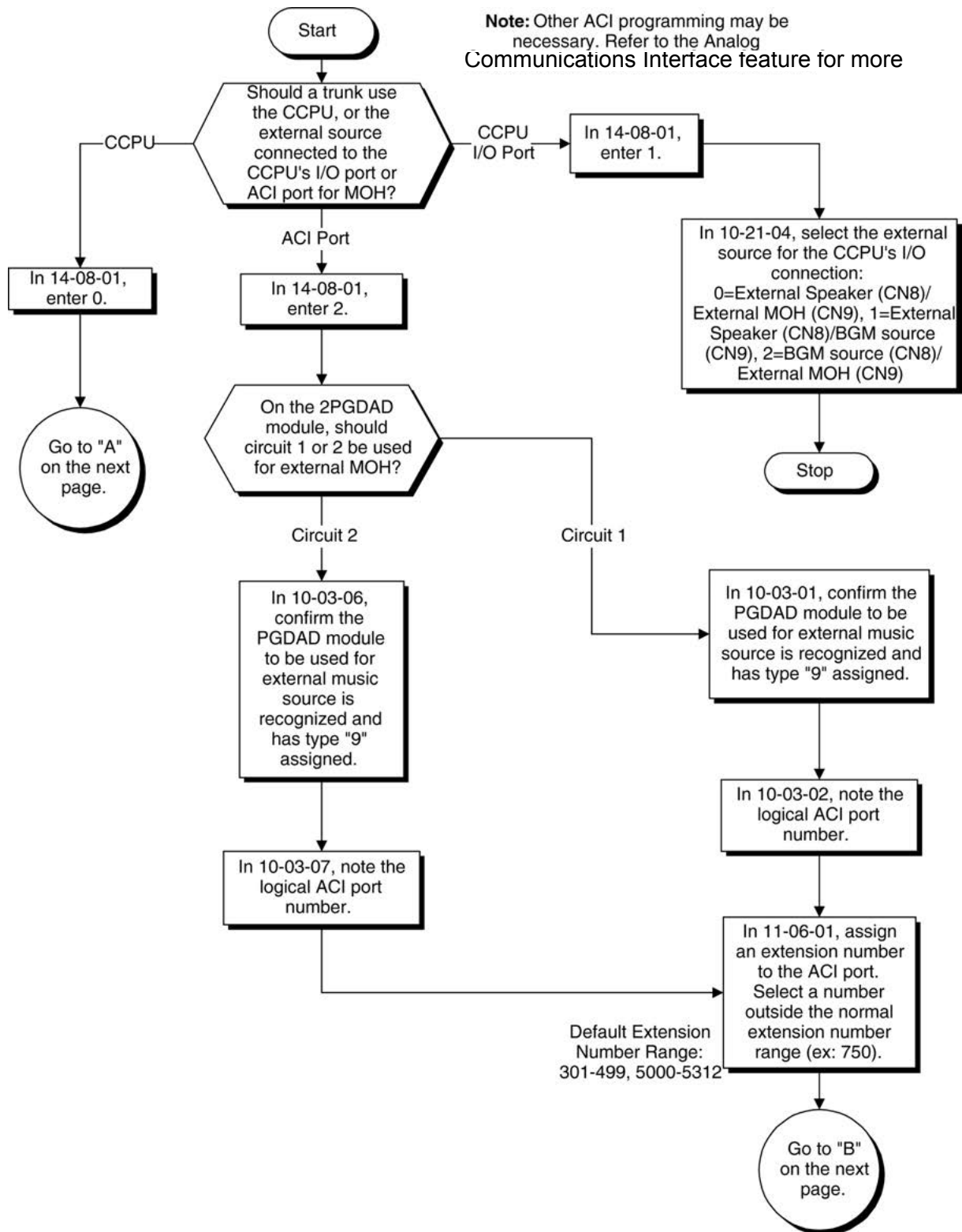

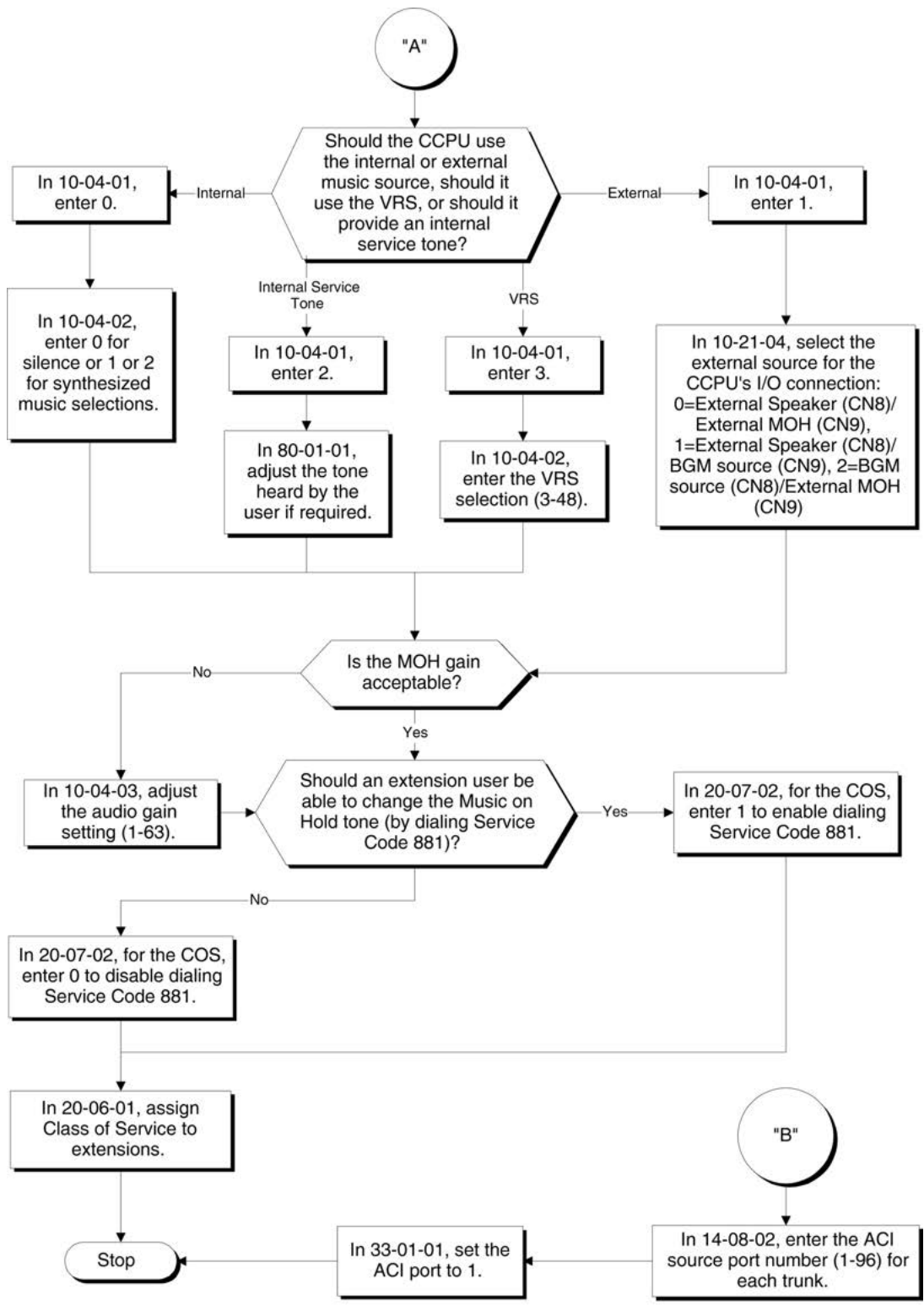

Operation

None



### Description

Extensions and trunks can have names instead of just circuit numbers. These names show on a multiline terminal display when the user places or answers calls. Extension and trunk names make it easier to identify callers. The user does not have to refer to a directory when processing calls. A name can have up to 12 digits, consisting of alphanumeric characters, punctuation marks and spaces.

### Additional Characters Available

When using Name Storing, the system now provides additional characters which can be used. These characters are available with any option which allows Name Storing - Speed Dial - System/Group/Station, One-Touch Keys, Extension Name, Trunk Naming.

### Conditions

- Display telephones use extension names for Directory Dialing.
- Single line extensions cannot program names.
- If a name is not assigned to the Extension/Virtual Extension, it does not show in the Extension Directory.
- Extension Directory only shows telephones/virtual extensions that have a name assigned in Program 15-01-01.

### Default Settings

Enabled

### System Availability

#### Terminals

All Multiline Terminals with Display

#### Required Component(s)

None

## Related Features

- [Directory Dialing](#)
- [Single Line Telephones, Analog 500/2500 Sets](#)
- [Speed Dial – System/Group/Station](#)

## Guide to Feature Programming

The **Level 1**, **Level 2** and **Level 3** columns indicate the programs that are assigned when programming this feature in the order they are most commonly used. These levels are used with PCPro and WebPro wizards for feature programming.

- Level 1 – these are the most commonly assigned programs for this feature.
- Level 2 – these are the next most commonly assigned programs for this feature.
- Level 3 – these programs are not often assigned and require an expert level working knowledge of the system to be properly assigned.

Program Number	Program Name/Description	Input Data	Default	Level		
				1	2	3
11-11-22	<b>Service Code Setup (for Setup/Entry Operation) – Extension Name Programming</b> Customize the service code used to edit Extension Name Programming.	MLT 0 ~ 9, *, # Maximum of eight digits	700		✓	
14-01-01	<b>Basic Trunk Data Setup – Trunk Name</b> Set the names for trunks. The trunk name displays on a multiline terminal for incoming and outgoing calls.	Maximum of 12 characters.	Line 001 Line 002 Line 003 : Line 400		✓	
15-01-01	<b>Basic Extension Data Setup – Extension Name</b> Define the extension/virtual extension name.	Maximum of 12 characters.	STA 101 = Ext 101 STA 102 = Ext 102, etc.	✓		
20-09-02	<b>Class of Service Options (Incoming Call Service) – Caller ID Display</b> Turn Off or On the Caller ID display at an extension.	0 = Off 1 = On	COS 1 ~ 15 = 0		✓	
20-13-21	<b>Class of Service Options (Supplementary Service) – Extension Name</b> Turn Off or On an extension user ability to program the name.	0 = Off 1 = On	COS 1 ~ 15 = 1		✓	
20-13-47	<b>Class of Service Options (Supplementary Service) – Station Number Display</b> Determine if a station Number is Displayed or Not Displayed in the LCD when the phone is idle.	0 = Not Displayed 1 = Displayed	COS 1 ~ 15 = 1		✓	

Program Number	Program Name/Description	Input Data	Default	Level		
				1	2	3
20-13-48	<b>Class of Service Options (Supplementary Service) – Station Name Display</b> Determine if a station Name is Displayed or Not Displayed in the LCD when the phone is idle.	0 = Not Displayed 1 = Displayed	COS 1 ~ 15 = 1		✓	
20-13-51	<b>Class of Service Options (Supplementary Service) – Number and Name appear in the Directory</b> Determine if an extension name and number are Listed or Unlisted in the directory.	0 = Not Listed 1 = Listed	COS 1 ~ 15 = 1		✓	

## Operation

### To program your extension name:

1. Press **Speaker**.
2. Dial **700**.  
  
- OR -  
Press the **Extension Name Change** key (Program 15-07 or SC 751: 55).
3. Press **Hold**.
4. Enter the name.  
◇ *Your name can be up to 12 digits maximum.*
5. Press **Hold**.
6. Press **Speaker** to hang up.

### To program any extension name:

1. Press **Speaker**.
2. Dial **700**.  
  
- OR -  
Press the **Extension Name Change** key (Program 15-07 or SC 751: 55).
3. Enter the extension number to be named.
4. Enter a name.  
◇ *The name can be have to 12 digits maximum.*
5. Press **Hold**.
6. Press **Speaker** to hang up.

Refer to [Table 2-90 Keys for Entering Names](#) for an explanation for using the keypad to enter names.

Table 2-90 Keys for Entering Names

Use this keypad digit . . .	When you want to . . .
1	Enter characters: 1 @ [ ¥ ] ^ _ ` {   } Æ " Á À Â Ã Ç É Ê Ì Ó
2	Enter characters: <b>A-C, a-c, 2.</b>
3	Enter characters: <b>D-F, d-f, 3.</b>
4	Enter characters: <b>G-I, g-i, 4.</b>
5	Enter characters: <b>J-L, j-l, 5.</b>
6	Enter characters: <b>M-O, m-o, 6.</b>
7	Enter characters: <b>P-S, p-s, 7.</b>
8	Enter characters: <b>T-V, t-v, 8.</b>
9	Enter characters: <b>W-Z, w-z, 9.</b>
0	Enter characters: 0 ! “ # \$ % & ’ ( ) ô Õ ú ä ö ü α ε θ
*	Enter characters: * + , - . / : ; < = > ? π Σ σ Ω ∞ ϕ £
#	# = Accepts an entry (only required if two letters on the same key are needed – ex: TOM). Pressing # again = Space. (In system programming mode, use the right arrow Softkey instead to accept and/or add a space.)
<b>Feature</b>	Clear the character entry one character at a time (when using service code or function key).
<b>Recall</b>	Clear the character entry one character at a time (when in telpro).
<b>Hold (Telpro Mode Only)</b>	Clear all the entries from the point of the flashing cursor and to the right.



## NEC Communications Analyst

### Description

NEC Communications Analyst is an easy to use, graphically oriented software package that allows you to monitor and analyze telephone calls, understand telephone usage, and cut costs. Incoming and outgoing calls are tracked accurately along with the date and time of the call. When the incoming telephone call must be tracked with name and/or telephone numbers, NEC Communications Analyst requires Caller ID service from the local telephone company.

NEC Communications Analyst increases productivity, facilitates billing, and helps detect toll fraud and telephone abuse. It also has powerful tabular (text) and graphic report generating ability. Reports include extension/line summaries, date, time, and department summaries, longest/most expensive calls, and most frequently called numbers. These reports can be used to analyze your telephone as a critical business communication tool, improve its business effectiveness, and reduce your telephone costs. A report can be generated showing calling patterns by volume or duration on a color-coded United States map. This can help Customer Support, Sales Order, or Telemarketing business become more focused, more productive, and more cost effective.

#### NEC Communications Analyst keeps track of:

- The date and time calls were made or received
- The duration of each call
- Which extension made or received the call
- The CID/ANI, DNIS of the caller
- The trunk or line numbers that handled the call
- Account codes and authorization codes used for the call
- CCIS calls are now logged with extension number and trunks used for CCIS. These trunks can be placed in a different line group in order to track usage across a CCIS link using the Traffic Analysis add-on feature.

#### Highlights of NEC Communications Analyst:

- NEC Communication Analyst now supports SV9100.
- NEC Communication Analyst supports NEC E911 Version 1.0.0.14.
- NEC Communications Analyst supports Exclusion/Inclusion list.
- NEC Communications Analyst supports Type of Call.
- NEC Communications Analyst supports Fixed cost by Extension.
- NEC Communications Analyst supports Encryption of SQL Password in the DSN.
- NEC Communications Analyst supports Web report Internet Explorer compatibility.
- NEC Communications Analyst supports SQL installer password length.

- NEC Communications Analyst supports Import contact Enhancements for duplicate check.
- NEC Communications Analyst supports MSRCMD acting as listener.
- NEC Communications Analyst supports changing FTP port number in Archive and Report Automation.
- Network based.
- CallAlert! This module can generate alarms by email, pager screen, screen pop-up, or .wav file. when it detects user defined patterns in the call records.
- Automatic report and data archival scheduling, to include automatic emailing of reports to predetermined destinations.
- Real-time inbound/outbound call monitoring.
- Changes can now be made to the call record such as Account Code Entry, DNIS, and comments field.
- Call costing and user configurable rate plans
- Time billing

**Included Reports:**

- Date and time summaries
- Most frequently called numbers
- Department summaries
- Extension and line summaries
- Longest and most expensive calls
- And many more

*Table 2-91 Communications Analyst Support*

Product	SV8100	SV9100
<b>Communications Analyst</b>	X	X
<b>CallAnalyst Enterprise Server</b>	-	-
<b>Elite CallAnalyst</b>	-	-

## Conditions



*Refer to the NEC Communications Analyst Installation and Configuration Guide installed with the software for more detailed information.*

- On the SV9100, previous versions of Communications Analyst (Elite CallAnalyst/ CallAnalyst Enterprise Server) are **not** supported.
- The following software items are installed on the PC:
  - ❑ Multi-Site Process Manager (MSPM) to collect call records from the system.
  - ❑ NEC Communications Analyst to allow reports and other Communications Analyst features.
  - ❑ SQL Express 2008 database.
  - ❑ Lite package is not available for NEC Communications Analyst.
  - ❑ Scheduler (default installed) to allow reports and database archival on a regularly scheduled basis.
  - ❑ NEC Communications Analyst Installation Guide (default installed, PDF format).
- The following optional modules of NEC Communications Analyst Software require license upgrade:
  - ❑ Network Client  
Network clients must then call NEC for additional licensing. The license is issued on the Communications Analyst Server installation. All license information is maintained on the UNIVERGE SV9100 GCD-CP10.
  - ❑ Traffic Analysis  
This tool allows users to view and analyze trunk capacity usage by date, time, and call direction.
  - ❑ Communications Analyst WebReports  
This module allows authorized users access to many of the available reports over the Internet using a web browser.
  - ❑ Monitors for emergency (911) calls made by the SV9100 and provides detailed automatic location information to monitoring agents (refer to [NEC E911 Security Notification on page 2-1215](#)).
- SMDR supports printing Intercom calls.
- The SMDR call buffer stores 4000 calls. The buffer stores calls when the SMDR device is unavailable. When the buffer fills, no new records are collected.
- The UNIVERGE SV9100 SMDR does not provide data to support the tracking of tandem calls or conference calls. Tandem calls appear as one call with extension number shown as the trunk it was answered on, and out with the extension number as the trunk used to make the call. Conference calls show only the last party to join the conference and the party that answered the call.
- If the Collate option is enabled in the Communications Analyst Multi-site Configuration, all legs of a call are combined into one call record. Also, the Communications Analyst will not release the call from the database until the trunk that this call was placed on is used again.

- Communications Analyst Web reports only supports Internet Explorer.
- Cannot restore SQL 2008 archive files of CA DB to SQL 2005 CA DB.
- Program incompatibility assistant window will display during Windows 7 Pro/Ultimate installation. Click **This program is installed correctly** option.
- If using a remote database, then the Windows account must be added to the SQL servers.

### Default Settings

None

## System Availability

### Terminals

All Terminals:

- Incoming CO/PBX Call
- Outgoing CO/PBX Call
- Conference CO/PBX Call
- Transferred CO/PBX Call

### Required Component(s)

LAN connection for SMDR over Ethernet and connection to the SV9100 license server.

### Minimum PC Requirements:



REFERENCE

*For a detailed list of PC Requirements and Operating Systems supported, refer to the NEC Communication Analyst Installation and Configuration Guide for the version being installed.*

## Related Features

- ↳ [Account Code Entry](#)
- ↳ [Account Code - Forced/Verified/Unverified](#)
- ↳ [Central Office Calls, Answering](#)
- ↳ [Central Office Calls, Placing](#)
- ↳ [Clock/Calendar Display](#)
- ↳ [E-911 Compatibility](#)
- ↳ [ISDN Compatibility](#)
- ↳ [Multiple Trunk Types](#)
- ↳ [Station Message Detail Recording](#)
- ↳ [T1 Trunking \(with ANI/DNIS Compatibility\)](#)
- ↳ [Traffic Reports](#)
- ↳ [Trunk Groups](#)

## Guide to Feature Programming

The **Level 1**, **Level 2** and **Level 3** columns indicate the programs that are assigned when programming this feature in the order they are most commonly used. These levels are used with PCPro and WebPro wizards for feature programming.

- Level 1 – these are the most commonly assigned programs for this feature.
- Level 2 – these are the next most commonly assigned programs for this feature.
- Level 3 – these programs are not often assigned and require an expert level working knowledge of the system to be properly assigned.

◇ For additional SMDR programming options, see [Station Message Detail Recording on page 2-1489](#).

Program Number	Program Name/Description	Input Data	Default	Level		
				1	2	3
14-01-06	<b>Basic Trunk Data Setup – SMDR Printout</b> Have the system Include (1) or Exclude (0) the trunk you are programming from the SMDR printout. Refer to Program 35-01 and 35-02 for SMDR printout options.	0 = No Print Out 1 = Prints Out	0	✓		

Program Number	Program Name/Description	Input Data	Default	Level		
				1	2	3
15-01-03	<b>Basic Extension Data Setup – SMDR Printout</b> For each extension, enter 1 if an extension call should appear on the SMDR report. Enter 0 for the extension if the calls should not appear.	0 = Do not print on SMDR report 1 = Include on SMDR report	1	✓		
35-01-01	<b>SMDR Options – Output Port Type</b> Specify the type of connection used for SMDR. The baud rate for the COM port should be set in Program 15-02-19.	0 = No setting 1 = Not used 2 = Not used 3 = LAN (CCPU) 4 = Not used	0	✓		
35-01-02	<b>SMDR Options – Output Destination Number</b> Specify the SMDR printer output extension (CTA extension number).	Maximum of eight digits.	No Setting		✓	
35-01-03	<b>SMDR Options – Header Language</b> Specify the language used to print the SMDR header.	0 = English 1 = German 2 = French 3 = Italian 4 = Spanish	0		✓	
35-01-04	<b>SMDR Options – Omit Digits</b> The number of digits entered for this option do not print on the SMDR Report (0 ~ 24). For example, if the entry is 10, the last 10 digits a user dials do not appear on the SMDR report.	0 ~ 24 (0 = Not applied)	0	✓		
35-01-05	<b>SMDR Options – Minimum Digits</b> Outgoing calls must have at least this number of digits for inclusion in the SMDR report (0 ~ 24).	0 ~ 24 (0 = Not applied)	0	✓		
35-01-06	<b>SMDR Options – Minimum Call Duration</b> A call must last at least this time to be included in the SMDR report.	0 ~ 65535 seconds (0 = All)	0	✓		
35-01-07	<b>SMDR Options – Minimum Ring Time (For Incoming Calls)</b> A call must ring for at least this time to be included in the SMDR report.	0 ~ 65535 seconds (0 = All)	0	✓		
35-01-08	<b>SMDR Options – Format Selection</b> Set the SMDR (Station Message Detail Recording) format for each of the eight SMDR ports.	0 = NA Type (North America) 1 = G/J Type (Overseas/ Japan)	0		✓	
35-02-01	<b>SMDR Output Options – Toll Restricted Call</b> Determine if SMDR can include or exclude calls blocked by Toll Restriction.	0 = Not Displayed 1 = Displayed	1	✓		
35-02-02	<b>SMDR Output Options – PBX Calls</b> When the system is behind a PBX, SMDR can include all calls (1) or just calls dialed using the PBX trunk access code (0).	0 = Not Displayed 1 = Displayed	1		✓	

Program Number	Program Name/Description	Input Data	Default	Level		
				1	2	3
35-02-03	<p><b>SMDR Output Options – Trunk Number or Name</b></p> <p>Select whether the system should display the trunk Name or Number on SMDR reports.</p> <p>➔ If this option is set to 0, Program 35-02-14 must be set to 0.</p>	<p>0 = Name</p> <p>1 = Number</p>	1		✓	
35-02-04	<p><b>SMDR Output Options – Summary (Daily)</b></p> <p>Set this option to 1 to have the SMDR report provide a daily summary (at midnight every night).</p>	<p>0 = Not Displayed</p> <p>1 = Displayed</p>	1		✓	
35-02-05	<p><b>SMDR Output Options – Summary (Weekly)</b></p> <p>Set this option to 1 to have the SMDR report provide a weekly summary (every Saturday at midnight).</p>	<p>0 = Not Displayed</p> <p>1 = Displayed</p>	1		✓	
35-02-06	<p><b>SMDR Output Options – Summary (Monthly)</b></p> <p>Set this option to 1 to have the SMDR report provide a monthly summary (at midnight on the last day of the month).</p>	<p>0 = Not Displayed</p> <p>1 = Displayed</p>	1		✓	
35-02-07	<p><b>SMDR Output Options – Toll Charge Cost</b></p> <p>Set this option to 1 to have the SMDR report include toll charges.</p>	<p>0 = Not Displayed</p> <p>1 = Displayed</p>	1		✓	
35-02-08	<p><b>SMDR Output Options – Incoming Call</b></p> <p>Enable this option (1) to have the SMDR report include incoming calls. If you disable this option (0), incoming calls do not print.</p>	<p>0 = Not Displayed</p> <p>1 = Displayed</p>	1		✓	
35-02-09	<p><b>SMDR Output Options – Extension Number or Name</b></p> <p>Set this option to 1 to have the SMDR report include extension numbers. Set this option to 0 to have the SMDR report include extension names.</p>	<p>0 = Name</p> <p>1 = Number</p>	1	✓		
35-02-10	<p><b>SMDR Output Options – All Lines Busy (ALB) Output</b></p> <p>Determine if the All Lines Busy (ALB) indication should be displayed.</p>	<p>0 = Not Displayed</p> <p>1 = Displayed</p>	0		✓	
35-02-11	<p><b>SMDR Output Options – Walking Toll Restriction Table Number</b></p> <p>Set the SMDR (Station Message Detail Recording) walking toll restriction table number output options for each of the eight SMDR ports.</p>	<p>0 = Not Output</p> <p>1 = Output</p>	1		✓	
35-02-12	<p><b>SMDR Output Options – DID Table Name Output</b></p> <p>Determine if the DID table name should be displayed for incoming DID calls.</p>	<p>0 = Not Displayed</p> <p>1 = Displayed</p>	0		✓	

Program Number	Program Name/Description	Input Data	Default	Level		
				1	2	3
35-02-13	<b>SMDR Output Options – CLI Output When DID to Trunk</b> Determine if the Caller ID should be displayed when the incoming DID number is transferred to an outgoing trunk.	0 = Not Displayed 1 = Displayed	0		✓	
35-02-14	<b>SMDR Output Options – Date</b> Determine if the date should be displayed on SMDR reports. ➤ <i>This option must be set to 0 if the trunk name is set to be displayed in Program 35-02-03.</i>	0 = Not Displayed 1 = Displayed	0	✓		
35-02-15	<b>SMDR Output Options – CLI/DID Number Switching</b> Determine whether the Caller ID number, or DID number should be displayed in the SMDR output.	0 = CLI (CLIP) 1 = DID Number 2 = Caller ID Name	0		✓	
35-02-16	<b>SMDR Output Options – Trunk Name or Received Dialed Number</b> Determine how the SMDR should print incoming calls on ANI/DNIS or DID trunks. If set to 1, ANI/DNIS trunks can print DNIS digits. For DID trunks, if the received number is not defined in Program 22-11-01, a number is not printed. If set to 0 trunk names are printed instead (assigned in Program 14-01-01).	0 = Trunk Port Name 1 = Received Dialed Number	0		✓	
35-02-17	<b>SMDR Output Options – Print Account Code or Caller Name of Incoming Call</b> Determine whether the Account Code or Caller ID name should print in the SMDR record. Program 35-01-08 must be set to 0 for this entry to be followed.	0 = ACC 1 = CNAME	0		✓	
35-02-18	<b>SMDR Output Options – Print Mode for Caller Name of Incoming Call</b> Select whether to display up to 16 characters of the Caller Name on the same line as the call record (0) or if a line feed should be added and up to 24 characters of the Caller Name are displayed on the following line (1). If the line feed option is selected, the Caller Name is displayed on the next line as : NEXT Caller Name. This setting works regardless of the setting in Program 35-02-15. ➤ <i>With this option set to 1, if your communications program (such as HyperTerminal) has the line wrap option enabled in the ASCII setup, an additional line break may appear above the Caller name line.</i>	0 = Normal 1 = Line Feed	0		✓	
35-03-01	<b>SMDR Port Assignment for Trunk Group</b> Assign the SMDR port for each trunk group. This is the SMDR port to which the incoming call information should be sent.	Trunk Group: 1 ~ 100, SMDR Port: 1 ~ 8	1	✓		



Program Number	Program Name/Description	Input Data	Default	Level		
				1	2	3
35-04-01	<b>SMDR Port Assignment for Department Groups</b> Assign the SMDR port for each department group. This is the SMDR port where the outgoing call information should be sent.	Department Group: 01 ~ 64 SMDR Port: 1 ~ 8	1		✓	

**LAN Connection:**

Program Number	Program Name/Description	Input Data	Default	Level		
				1	2	3
10-12-09	<b>GCD-CP10 Network Setup – IP Address</b> When using an IP connection, set up the GPZ-IPLE IP address used to connect from the CommAnalyst PC to the system.	0.0.0.0 ~ 126.255.255.254 128.0.0.1 ~ 191.254.255.254 192.0.0.1 ~ 223.255.255.254	172.16.0.10	✓		
10-20-01	<b>LAN Setup for External Equipment – TC Port</b> When using an IP connection, define the TCP port used for communicating to the CommAnalyst (External Device 5 = SMDR, Entries: 0 ~ 65535). This entry must match the entry made in the CDM setup with the CommAnalyst program.	0 ~ 65535	External Device 1 (CTI Server) = 0 External Device 2 (MIS) = 4000 External Device 5 (SMDR Output) = 0 External Device 6 (DIM Output) = 0 External Device 11 (O&M Server) = 8010 External Device 12 (Traffic Report Output) = 0 External Device 13 (Room Data Output for Hotel Service) = 0		✓	
10-20-03	<b>LAN Setup for External Equipment – Keep Alive Time</b> Define the TCP port/address/etc.	1 ~ 255 seconds	30		✓	

### Programming Notes:

- ❑ If the system is programmed to display the date (Program 35-02-14=1), the date is displayed regardless of the setting for display of trunk name (Program 35-02-03) and only the trunk number is printed.
- ❑ For example, if trunk port 049 has a trunk name of PRI Ch1, if Program 35-02-03 = 0 (name) and Program 35-02-14 = 1 (display date), then SMDR shows 8/19 049. However, if Program 35-02-14 = 0 (date not displayed), the SMDR shows PRI Ch1.
- ❑ For proper handling of DNIS calls, the name field (Program 22-11-03) must be the same as the received DNIS digits (Program 22-11-01 and Program 35-02-12 DID Table Name must be turned On). If this is not set, NEC Communications Analyst cannot track transferred calls since the system displays the DNIS number when a call is received and displays the DNIS name for transferred calls. This setting has no impact on outgoing calls, which display the trunk name instead of the DNIS name.
- ❑ Caller ID name can be displayed in SMDR records. Program 35-02-17 must be set to 0 and Program 35-02-18 set to 1.

## Operation

Refer to [Central Office Calls, Answering on page 2-206](#) and [Central Office Calls, Placing on page 2-230](#) features for detailed operations for placing or answering calls.

# NEC E911 Security Notification

## Description

The NEC E911 Security Notification (ESN) Application Suite, an easy-to-use yet powerful E911 notification solution. The E911 Security Notification solution offers robust features designed specifically for business users who want to make use of the Enhanced 911 call notification during emergencies.



*This application requires the latest full build of NEC Communications Analyst to be installed as a prerequisite.*

Figure 2-67 E911 Deployment Example

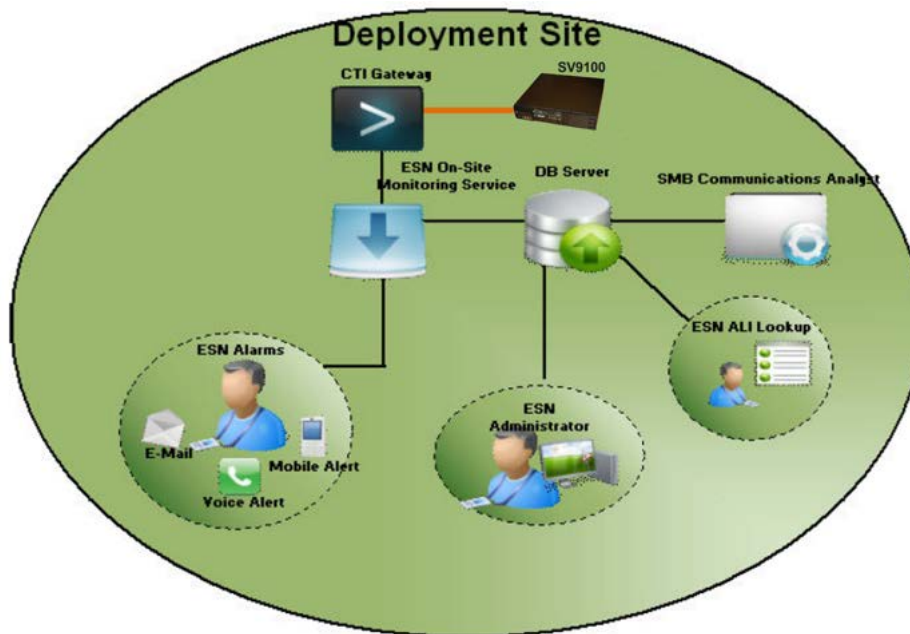

## Conditions

- ESN setup requires **NEC Communications Analyst build 5315 or higher** to be installed prior to running the ESN installation.
- ESN Alarm and ESN ALI Lookup works with Adobe Acrobat Reader version 11.0 and above only.
- The EOMS Service needs to be restarted after SQL Server restarts, the PC restarts or whenever the Microsoft SQL Server service is started after the EOMS service enters a running state.
- Changes made in the Administrator Console requires restarting all the EOMS services to take effect.

- Propagating the changes made using the Administration Console to the ESN Alert clients will require the Admin.ini file to be shared for the clients to access them over a network.
- The Licence.lic file from the NEC Communications Analyst needs to be made available to the ESN Administrator Console for the ESN related license.
- ESN Alarm clients installed on VM ware PC's can not listen to the audio alarms.
- Firewall/Antivirus rule exceptions need to be made for the services to communicate.

### Platform Requirements:

Ensure the following hardware and software requirements are met before starting the E911 Security Notification solution installation.



NOTE

*These recommendations are to be used as a minimum requirements guideline only. The actual requirements may vary based on the specific needs such as the call volume, number of remote locations etc.*



REFERENCE

*For a detailed list of PC Requirements and Operating Systems supported, refer to the E911 Security Notification (ESN) Installation, Setup & ESN Administrator Guide for the version being installed.*

### ESN Solution:

- Hardware:
  - Pentium 1.8 GHz core 2 duo or above
  - 4 GB RAM
  - 20 GB of free hard disk space
  - SVGA monitor 1024X 768 resolution
  - Network Interface card (NIC)
- Supported Operating Systems:
  - Windows Server 2003 with SP2
  - Windows XP Professional with SP3

### Client Side Requirements:

- Hardware:
  - Pentium 4 class machine
  - At least 512 MB RAM
  - SVGA monitor 1024X 768 resolution
- Supported Operating Systems:
  - Windows Server 2003 with SP2
  - Windows XP Professional with SP3
  - Vista with SP1

## Guide to Feature Programming

The **Level 1**, **Level 2** and **Level 3** columns indicate the programs that are assigned when programming this feature in the order they are most commonly used. These levels are used with PCPro and WebPro wizards for feature programming.

- Level 1 – these are the most commonly assigned programs for this feature.
- Level 2 – these are the next most commonly assigned programs for this feature.
- Level 3 – these programs are not often assigned and require an expert level working knowledge of the system to be properly assigned.



*Refer to the NEC Communications Analyst E911 Security Notification Application Suite Installation, Setup and ESN Administrator Guide for detailed instructions.*

Program Number	Program Name/Description	Input Data	Default	Level		
				1	2	3
10-20-01	<b>LAN Setup for External Equipment – TC Port</b> When using an IP connection, define the TCP port used for communicating to the CommAnalyst (External Device 5 = SMDR, Entries: 0 ~ 65535). This entry must match the entry made in the CDM setup with the CommAnalyst program.	0 ~ 65535	External Device 1 (CTI Server) = 0 External Device 2 ( MIS) = 4000 External Device 5 (SMDR Output) = 0 External Device 6 (DIM Output) = 0 External Device 11 (O&M Server) = 8010 External Device 12 (Traffic Report Output) = 0 External Device 13 (Room Data Output for Hotel Service ) = 0	✓		
41-01-03	<b>System Options for – MIS Connection Ports</b> Define what port is used for MIS connection. Currently only LAN is supported.	0 = None 3 = LAN (GCD-CP10)	0	✓		

## NEC Meeting Center (NMC)

### Description

The SV9100 can support the NEC Meeting Center (NMC) feature. NEC Meeting Center, a sophisticated audio conferencing, web collaboration and mass notification solution for the SV9100, equips your employees with the tools they need to help them improve efficiency, lower spending by reducing the need for travel and stay informed. As a result, your employees become more responsive and productive through real-time sharing of information and most importantly, service your customers better.

The maximum supported port capacity is 24 ports on one blade and integrates to the SV9100 system using Standard SIP extensions. This means that up to 24 simultaneous people can be in one Audio Conference or in multiple Audio Conferences at the same time (sum total equals 24). This simultaneous audio conferencing is in addition to any web collaboration conferencing as well.

Each NMC GCD-SVR2 blade comes with eight Audio and eight Web Conference port licenses at default additional licenses can be added if needed.

### General

- Web portal for Administrator
- Web Portal for Moderators
- Bulk upload of users and groups for mass notifications via CSV file upload
- LDAP support for remote authentication
- Multiple Information Assurance features for platform security

### Audio Conferencing Application

Audio Conferencing Application provides rich conferencing experience for demanding users.

### NMC Capacity

- Audio conferencing ports: 24
- Video conferencing ports: 8
- Audio Conference Recording Ports: 4
- Audio Recording storage capacity: 300 hours

### NMC Audio Conferencing Features

- Support both reservation-less and reservation based audio conferences.
- Customize each audio conference room per your requirements, e.g., select entry tones, select memorable vanity PINs, turn recording on/off, select auto-call back on/off, select enter audio conference muted on/off etc.
- Schedule recurring audio conferences via the Web Portal. Use Microsoft Outlook® iCalendar application to send invitations to desired participants.

- See real time view of a running audio conference via Web Portal. Participants can be seen by name or by caller ID.
- Display loudest speaker. Allows the identification and muting of a participant who may be inadvertently injecting noise into the audio conference.
- Exercise multiple in-conference controls via phone key presses or the Web portal.
- Auto mute noisy lines or lines with excessive echo.
- Merge two or more audio conferences into one without dropping any calls by transferring participants between conferences.
- Send a detailed end of conference summary report to the moderator after a given audio conference is over.
- Record entire conference or excerpts from a conference and playback via PC's media player or via dial-in IVR.
- Forward usage data and associated CDRs to an external billing system via TCP/IP based interface.
- Operator assisted conference
- Secure Audio Conference calls.

Table 2-92 Feature Support Table for Standard SIP Device

Feature	How it Works	Benefits
Ad-hoc 'Meet Me' audio conference.	Moderator and participants agree upon a start time and PIN to use. When people dial in and enter their PIN, they are placed in the conference.	Simple to use. No/little training required.
Scheduled 'Meet Me' with PIN audio conference.	Schedule from familiar Microsoft Outlook Calendar after checking for participant availability.	Use your existing Outlook 'contacts'. Calendar automatically reminds participants about upcoming conference.
Dialed number (DNIS) based audio conference.	Multiple participants simply dial a phone number and join an audio conference.	No PINs to remember.
Progressive dial out audio conference.	Moderator can dial out from the conference bridge and bring participants into a conference one by one.	Impromptu conferencing, no need to inform participants ahead of time.
Instantaneous Dial out with 'Find-you' conference (with Firebar option).	Incoming calls trigger a dial out conference. Conference Bridge will call participants at multiple locations and connect them into an audio conference.	Communicate with a 'group' with a single key press.
Scheduled Dial out with 'Find-you' conference.	At a scheduled time, conference bridge will trigger a dial out conference.	Reduces excuses for not joining a conference.

## Web Conferencing Application

- ❑ NMC Capacity
  - Web Conference Ports: 8
- ❑ NMC Web Conference Features
  - Web based application, no software download required
  - Web Browser: Internet Explorer® 7 and above, Firefox®, Mac Safari®
  - Maximum document size (10Mb) for uploading in web conference
  - Microsoft Office® 2003 and 2007 document support
  - PDF, JPEG, TIFF, BMP document support
  - Application sharing
  - Desktop sharing
  - Instant messaging
  - Sharing participant control.

Table 2-93 Feature Support Table for Standard SIP Device

Feature	How it Works	Benefits
Desk Top Sharing Mode.	Moderator shares his/her Desktop with fellow participants.	Show any document or co-browse the Web with fellow participants. Simple to use and ideal for product demos.
Presentation Sharing Mode.	Upload PowerPoint® and PDF documents. Use annotation tools to edit in a collaborative session.	Significantly reduce number of edits/versions to produce final version.
White Boarding Mode	Create diagrams/visuals with fellow participants in a collaborative session.	Ideal for brainstorming.
Public & private Chat Room	Moderator can respond to questions in public or privately.	Makes Web conferencing more productive.
Multiple Presenters	Moderator can allow another participant to take control and share their desktop.	Multiple points of view on one conference.

## Mass Notification

- ❑ NMC Capacity
  - Up to 24 ports shared with Audio Conference application.
- ❑ NMC Mass Notification Features
  - Select communications medium to be used for message delivery (Voice only, Email only, Voice and SMS, etc.)
  - Use built-in 'Find-you' capability to increase the probability of delivering a message.
  - Send caller-ID of your choice that can be used by cell phones to display associated 'caller name' (e.g., Security Alert') – leading to higher percentage of people picking up a message.
  - Control the speed of dialing out.
  - Display real time call activity and a progress bar on a Web Portal.
  - Abandon a Group Alert in progress via web portal or through DTMF.



- Provide summary and detailed reports on call completions (Busy, No Answer, Answering machine etc.)

*Table 2-94 Feature Support Table for Standard SIP Device*

Feature	How it Works	Benefits
Pre-recorded message delivery	Pro-actively build call out groups. Pre-record messages and tie groups and messages into Group Alert sessions. Trigger dial out from Web Portal or with incoming phone call.	Make messaging a planned activity. No need to search for address books at the time of actual need.
On-the-fly Message Delivery	Dial into the server, enter a PIN, record/re-record a message and send.	Quick dissemination of emergency oriented messages.
Built-in 'Find-You' capability	System captures up to four phone numbers per individual and dials them successively until making a positive contact.	Increases probability of delivering a message.
Announcement Box capability	Moderator periodically dials in and records a message in an announcement box. People can call in and hear the updated message.	Great way to inform people during changing emergency situations such as hurricanes, blackouts etc.
Re-iteratively contact the uncontacted	Set up Group Alert with 'un-contacted' option. Trigger same Group Alert multiple times until message is received by desired percentage of recipients.	No wasted calls. Iteratively build up the percentage of people who received calls.
Send message to 'contacted' people	Use 'swap' to convert contacted into uncontacted and send a new message.	Only people who received a previous message will get the new message. Great way to send 'all clear' message.

**Firebar Emergency Conferencing**

- ❑ NMC capacity
  - Up to 24 ports shared with Audio Conference application.
- ❑ NMC Firebar Conferencing Features
  - Can be used with legacy TDM network or with the next generation VoIP network.
  - Send calls to any landline or cellular phone instead of just dedicated 'red' or emergency phones.
  - Select communications medium to be used for message delivery (Voice only, Email only, SMS only or any combination etc.)
  - Support unlimited number of call out groups.
  - Send caller-ID of your choice that can be used by recipient's phone to display associated 'caller name' (e.g., Fire Chief).
  - Trigger a dial-out based on a) incoming phone call, b) click on a web portal, c) dry contact closure (optional).
  - Schedule one time or recurring dial out calls.
  - Display real time call activity on a Web Portal.
  - Support analog or digital phones with Push to Talk handsets.
  - Display individual line status (on-hook, off-hook etc.)
  - Provide summary and detailed reports on call completions (Busy, No Answer, Answering machine etc.)

## Conditions

- Web Conference ports support video only. A conference audio port is required for audio support.
- Only the G.711 CODEC is supported (Program 84-19-28) when integrating the SV9100 with the NMC.
- Each NMC GCD-SVR2 blade comes with eight audio and eight web conference port licenses as default. Additional licenses can be added if required.
- Integration of the NMC to the SV9100 is by standard SIP extensions.
- The SV9100 must be licensed for 1 IP Terminal License (5111), 1 VoIP Resource (5103) and 1 port license (0300) for each NMC voice port.
- The NMC cannot send a hook flash to Telco.
- The Web Conferencing video travels on port 1935. If that port is not available, it will tunnel to port 80, but performance is impacted.
- Desk Top sharing travels on port 1270. If that port is not available, it will tunnel to port 80, but performance is impacted.
- Each Web Conference participant uses approximately 277Kb/s per video stream.
- Web Conference participant video resolution is limited to 640 X 380.
- Manual registration is not supported for NMC SIP extensions.
- Encryption is not supported on NMC extensions.
- There is no mechanism to default the NMC application or server blade settings.
- The drive is married to the GCD-SVR2 blade and cannot be moved to another GCD-SVR2.
- The 10 and 60 day licenses have no effect on NEC Meeting Center features or capacities.
- All NEC Meeting Center feature licenses are applied to and stored on the NMC/GCD-SVR2 blade. NMC application licenses are not stored on the SV9100.

## Default Settings

None

## System Availability

### Terminals

None

### Required Component(s)

- GCD-SVR2 blade with NMC Application
- 5111 – SV9100 IP Phone Lic
- 0411 – SV9100 Version Lic (R1)
- 0300 – SV9100 Resource Lic
- 5103 – SV9100 IP Resource Lic

### Related Features

None

### Guide to Feature Programming

The **Level 1**, **Level 2** and **Level 3** columns indicate the programs that are assigned when programming this feature in the order they are most commonly used. These levels are used with PCPro and WebPro wizards for feature programming.

- Level 1 – these are the most commonly assigned programs for this feature.
- Level 2 – these are the next most commonly assigned programs for this feature.
- Level 3 – these programs are not often assigned and require an expert level working knowledge of the system to be properly assigned.

Program Number	Program Name/Description	Input Data	Default	Level		
				1	2	3
<b>10-12-01</b>	<b>GCD-CP10 Network Setup – IP Address</b> Assign the IP Address. Set to 0.0.0.0	0.0.0.0 ~ 126.255.255.254 128.0.0.1 ~ 191.255.255.254 192.0.0.1 ~ 223.255.255.254	192.168.0.10		✓	
<b>10-12-09</b>	<b>GCD-CP10 Network Setup – IP Address</b> Set to static IP address for local network.	0.0.0.0 ~ 126.255.255.254 128.0.0.1 ~ 191.255.255.254 192.0.0.1 ~ 223.255.255.254	172.16.0.10		✓	

Program Number	Program Name/Description	Input Data	Default	Level		
				1	2	3
10-54-01	<p><b>License Configuration for Each Package – License Code</b></p> <p>Assign VoIP Resource Licenses (5103) to GCD-CP10 slot (1).</p> <p>If applying more than 255 licenses to a slot, the licenses must be applied across multiple indexes.</p> <p>For example, assigning 256 VoIP resource licenses (5103) to the CPU slot could be assigned using different methods as long as the total for the CPU slot is 256.</p> <p>1. Index 1 has 128 of feature code 5103 and index 2 also has 128 of feature code 5103 for a total of 256.</p> <p>2. Index 1 has 255 of feature code 5103 and index 2 has 1 of feature code 5103 for a total of 256.</p>	1 ~ 255 Resource Licenses	0		✓	
11-01-01	<p><b>System Numbering – Service Code</b></p> <p>Customize the system internal (Intercom) numbering plan.</p>	Customize the system internal (Intercom) numbering plan.	Refer to the Programming Manual for default values.		✓	
11-02-01	<p><b>Extension Numbering</b></p> <p>Assign extension numbers to extension ports. The telephone programming identity follows the port number – not the extension number.</p>	Maximum of eight digits.	1 101 2 102 3 103 ~ ~ 99 199 100 3101 ~ ~ 960 3961		✓	
14-02-23	<p><b>Analog Trunk Data Setup – Caller ID Receiving Method</b></p> <p>Set to 0 (Wait for Caller ID) for all trunks.</p>	0 = Wait Caller ID 1 = Immediate Ring	1		✓	
15-03-03	<p><b>Single Line Telephone Basic Data Setup – Terminal Type</b></p> <p>Set to 1 (Special) for all XOP ports.</p>	0 = Normal 1 = Special	0	✓		
15-05-18	<p><b>IP Telephone Terminal Basic Data Setup – IP Duplication Allowed Mode</b></p> <p>Allows 1 IP Address to be assigned to multiple extensions.</p>	0 = Disabled 1 = Enabled	0	✓		
15-07-01	<p><b>Programmable Function Keys</b></p> <p>Program one Call Appearance Key (CAP Key) on each NMC extension.</p>	Line Key 1 ~ 48 0 ~ 99 (Normal Function Code 751 by default) *00 ~ *99 (Appearance Function Code) (Service Code 752 by default) (*08 + XXXX = CAP key where XXXX is the CAP orbit number 0001 ~ 9999)	Refer to the Programming Manual for default values.	✓		

Program Number	Program Name/Description	Input Data	Default	Level		
				1	2	3
84-26-01	<b>IPL Basic Setup – IP Address</b> Assign the IP address for the DSP on the GPZ-IPLE.	xxx.xxx.xxx.xxx	Slot 1 = 172.16.0.20		✓	
90-61-01	<b>Manual Slot Install – Install</b> This can only be set via phone programming. For the slot the SVR2 is installed in set Program 90-61-01 to 3 (Server Blade). This is done so the slot is populated in Web Pro or on a PC Pro download. ➡ <i>This program is available only via telephone programming and not through PC Programming.</i>	0 = None 1 = Router 2 = PVA-NAT 3 = Server Blade 4 = PVA-DCU	0	✓		

## Operation

None

## Description

Night Service lets system users activate one of the Night Service modes. Night Service redirects calls to their night mode destination, as determined by Assigned and Universal Night Answer programming. A user typically activates Night Service after normal working hours, when most employees are unavailable to answer calls.

- ❑ There are eight Service Modes. At default, the mode names are assigned as follows:
  - Mode 1 = No setting
  - Mode 2 = Night
  - Mode 3 = Midnight
  - Mode 4 = Rest
  - Mode 5 = Day2
  - Mode 6 = Night2
  - Mode 7 = Midnight2
  - Mode 8 = Rest2
  
- ❑ There are four Service Patterns/Groups available.
 

The following LED flash patterns are available on the toggle key (Version 3000 or higher required):

**Multiline Terminal (4-wire)**

  - Mode 1 or Mode 5 ~ 8: Off
  - Mode 2: On (Red)
  - Mode 3: Slow Flash (Red: 500ms On/Off)
  - Mode 4: Fast Flash (Red: 100ms On/Off)

**Multiline Terminal (2-wire)**

  - Mode 1 or Mode 5 ~ 8: Off
  - Mode 2: On (Red)
  - Mode 3: Slow Flash (Red: 250ms On/Off)
  - Mode 4: Fast Flash (Red: 125ms On/125ms Off/125ms On/625ms Off)

### Assigned Night Answer (ANA)

With Assigned Night Answer (ANA), Night Service has calls ring extensions directly. Assigned Night Answer provides an answering point for Night Service calls. For certain applications, this may be more appropriate than Universal Night Answer. For example, you could program trunks to ring the security station telephone during off hours.

For more information on assigning trunks to ring extensions, refer to [Direct Inward Line \(DIL\) on page 2-438](#).

## Universal Night Answer (UNA)

Universal Night Answer makes incoming calls ring over the External Paging speakers. With UNA, an employee can go to a telephone and press the flashing line key or use Universal Answer to pick up the call. Only ring groups calls can be used with Universal Night Answer. For more on setting up Universal Answer, refer to [Central Office Calls, Answering on page 2-206](#).

You may also use Transfer to UNA. An extension user can transfer their call to UNA (i.e., External Paging at night). Once transferred, the call rings the External Paging speakers like any other UNA call and can be picked up at any extension. You can also set up Transfer to UNA through the Voice Response System (VRS). This lets outside callers, answered by the VRS, dial a code to have their call ring External Paging.

## Automatic Night Service

The system allows or denies Automatic Night Service. If allowed, the calls route according to the service patterns programmed. The Night Service programming is stored in the RAM memory. This means that if the system is not using the Automatic Night Service, for a power failure in night mode, when the power is restored, the system continues to be in night mode.

## Programmable Function Key Can Toggle Night Modes

The software allows a Night Service Programmable Function Key (Program 15-07-01 or SC 751: 09 + 0) to toggle night modes. You can determine in programming (Program 12-08-01) how many modes through which the user toggles. Note that the additional data for the Programmable Function Key must be set to 0 for the toggle function to work.

### Conditions

- Almost all features are affected by Night Mode except the following:
  - ❑ Dial Tone Detection
  - ❑ External Alarm Sensors
  - ❑ Flexible System Numbering
  - ❑ Pulse to Tone conversion
  - ❑ SMDR
  - ❑ Volume Control
- Call Arrival (CAR) Keys and Virtual Extension keys do not support Day/Night Mode (09) Programmable Function keys.
- Universal Night Answer only works when Call is sent to a ring group.
- A Separate Access Map and Ring Group programming entry is available for each Night Service mode (modes 1~8). Also, Universal Answer allows an extension user to pick up a Universal Night Answer (UNA) call.
- Mode Keys can be assigned as required for DSS Consoles.
- With Universal Night Answer, outside calls can ring External Paging Zones.

- Programmable Function Keys simplify activating Night Service.
- The relay circuits (5~8) are on the PGD(2)-U10 ADP are programmed and used for General Purpose Relays.
- When programming Night Service function keys, multiple keys must be used for switching between each Night Service Mode.
- Virtual Extension Ring Assignment (command 15-09) follows the ring assignment for the Night Mode Group the virtual extension is assigned to (default Night Mode Group 1) and not the Night Mode Group of the keyset the virtual is appearing on.
- With Version 3000 or higher software, the LED on the Night Mode Toggle Key can be lit.

### Default Settings

System is always in the Mode 1

## System Availability

### Terminals

None

### Required Component(s)

None

## Related Features

- ➔ **Central Office Calls, Answering**
- ➔ **Central Office Calls, Placing**
- ➔ **Direct Station Selection (DSS) Console**
- ➔ **Paging, External**
- ➔ **Programmable Function Keys**
- ➔ **Ring Groups**



## Guide to Feature Programming

The **Level 1**, **Level 2** and **Level 3** columns indicate the programs that are assigned when programming this feature in the order they are most commonly used. These levels are used with PCPro and WebPro wizards for feature programming.

- Level 1 – these are the most commonly assigned programs for this feature.
- Level 2 – these are the next most commonly assigned programs for this feature.
- Level 3 – these programs are not often assigned and require an expert level working knowledge of the system to be properly assigned.

Program Number	Program Name/Description	Input Data	Default	Level		
				1	2	3
11-10-01	<b>Service Code Setup (for System Administrator) – Night Mode Switching</b> Customize the service code (718) used for day/night mode switching.	MLT, SLT 0 ~ 9, *, # Maximum of eight digits	718		✓	
11-10-12	<b>Service Code Setup (for System Administrator) – Night Mode Switching for Other Group</b> Customize the service code (618) used for Day/Night mode switching for another Night service group.	MLT 0 ~ 9, *, # Maximum of eight digits	618		✓	
11-12-43	<b>Service Code Setup (for Service Access) – Answer No-Ring Line (Universal Answer)</b> Customize the service code (#0) used to manually answer a Universal Night Answer.	MLT, SLT 0 ~ 9, *, # Maximum of eight digits	#0		✓	
11-12-50	<b>Service Code Setup (for Service Access) – General Purpose Relay</b> Define the service code used for turning the general purpose relay on and off.	MLT, SLT 0 ~ 9, *, # Maximum of eight digits	780		✓	
12-01-01	<b>Night Mode Function Setup – Manual Night Mode Switching</b> Turn Off or On an extension user ability to activate Manual Night Service.	0 = Off 1 = On	1	✓		
12-01-02	<b>Night Mode Function Setup – Automatic Night Mode Switching</b> According to a preset schedule, Enable (1) or Disable (0) Automatic Night Service for the system. Make sure to set the Service Patterns in Program 12-02-01, Program 12-02-02 and Program 12-02-03.	0 = Off 1 = On	0		✓	
12-02-01	<b>Automatic Night Service – Start Time</b> For each Night Service Group, enter up to 20 start times for each Time Pattern (1 ~ 10). The first pattern start time (Pattern 1) should begin at 00:00 (midnight).	0000 ~ 2359	Refer to the Programming Manual for default values.	✓		

Program Number	Program Name/Description	Input Data	Default	Level		
				1	2	3
12-02-02	<b>Automatic Night Service – End Time</b> For each Night Service Group (01 ~ 32), enter up to 20 end times (0000 ~ 2359) for each Time Pattern (1 ~ 10).	0000 ~ 2359	Refer to the Programming Manual for default values.	✓		
12-02-03	<b>Automatic Night Service – Operation Mode</b> For each Night Service Group (01 ~ 32), define the Night Service Mode (1 ~ 8) for up to 20 start/end times for each Time Pattern (1 ~ 10).	1 ~ 8	Refer to the Programming Manual for default values.	✓		
12-03-01	<b>Weekly Night Service Switching</b> Assign one of the 10 Time Patterns programmed in Program 12-02-01 to each day of the week.	Night Mode Service Group Numbers: 01 ~ 32 Time Schedule Pattern Number: 1 ~ 10 Day of Week: 01 = Sunday 02 = Monday 03 = Tuesday 04 = Wednesday 05 = Thursday 06 = Friday 07 = Saturday	01 = Sunday (default = Time Pattern 2) 02 = Monday (default = Time Pattern 1) 03 = Tuesday (default = Time Pattern 1) 04 = Wednesday (default = Time Pattern 1) 05 = Thursday (default = Time Pattern 1) 06 = Friday (default = Time Pattern 1) 07 = Saturday (default = Time Pattern 2)	✓		
12-04-01	<b>Holiday Night Service Switching</b> Assign one of the 10 Time Patterns to holidays.	Days and Months: 0101 ~ 1231 (e.g. 0101 = Jan. 1; 1231 = Dec. 31) Time Pattern Number: 0 ~ 10 (0 = No Setting)	No Setting	✓		
12-05-01	<b>Night Mode Group Assignment for Extensions</b> Assign a Day/Night Mode Group (01 ~ 32), for each extension.	Night Mode Service Group Number: 01 ~ 32	1	✓		
12-06-01	<b>Night Mode Group Assignment for Trunks</b> Assign a Day/Night Mode Group (01 ~ 32), for each trunk port (1 ~ 400).	Trunk Port Number: 001 ~ 400 Night Mode Service Group Number: 01 ~ 32	1	✓		

Program Number	Program Name/Description	Input Data	Default	Level		
				1	2	3
12-07-01	<p><b>Text Data for Night Mode</b></p> <p>Create an original text message which is displayed on an LCD of multiline terminal in each Night Mode.</p>	<p>Night Mode Service Group Number: 01 ~ 32</p> <p>Day/Night Mode: 1 ~ 8</p> <p>Text Message: Maximum 12 Characters (alphabetic or numeric)</p>	<p>Default Text Messages for Day/Night Modes:</p> <p>Mode 1 = No Setting</p> <p>Mode 2 = &lt;Night&gt;</p> <p>Mode 3 = &lt;Midnight&gt;</p> <p>Mode 4 = &lt;Rest&gt;</p> <p>Mode 5 = &lt;Day2&gt;</p> <p>Mode 6 = &lt;Night2&gt;</p> <p>Mode 7 = &lt;Midnight2&gt;</p> <p>Mode 8 = &lt;Rest2&gt;</p>	✓		
12-08-01	<p><b>Night Mode Service Range</b></p> <p>For each Night Mode Group (01 ~ 32), determine how many night modes a user toggles through when the Night Mode key is pressed.</p>	<p>Night Mode Service Group Number: 01 ~ 32</p> <p>Range: 2 ~ 8</p>	2	✓		
14-07-01	<p><b>Trunk Access Map Setup</b></p> <p>To allow for Universal Night Answer (UNA) answering, set up the Trunk Access Maps (1 ~ 400). For UNA, extension must have incoming access to trunk ringing the External Paging speakers.</p>	<p>0 = No access</p> <p>1 = Outgoing access only</p> <p>2 = Incoming access only</p> <p>3 = Access only when trunk on Hold</p> <p>4 = Outgoing access and access when trunk on Hold</p> <p>5 = Incoming access and access when trunk on Hold</p> <p>6 = Incoming and Outgoing access</p> <p>7 = Incoming access, outgoing access and access when trunk on Hold</p> <p>Trunk Access Maps: 1 ~ 400</p>	<p>Access Maps</p> <p>1 ~ 400 = Trunk Ports 1 ~ 400 assigned with option 7 access (incoming and outgoing access and access when trunk is on Hold).</p>	✓		
15-06-01	<p><b>Trunk Access Map for Extensions</b></p> <p>For Universal Night Answer (UNA) answering, assign Trunk Access Maps (1 ~ 400) to extensions. Make one entry for each Night Service mode.</p>	<p>Trunk Access Maps: 1 ~ 400</p>	1	✓		

Program Number	Program Name/Description	Input Data	Default	Level		
				1	2	3
15-07-01	<b>Programmable Function Keys</b> Assign Night Service function keys (09) to extensions and set the key for the proper mode (Day, Night, Rest, etc.). If the additional data is set to 0, the toggle mode is assigned.	Line Key 1 ~ 48 0 ~ 99 (Normal Function Code 751 by default) *00 ~ *99 (Appearance Function Code) (Service Code 752 by default)	Refer to the Programming Manual for default values.	✓		
20-06-01	<b>Class of Service for Extensions</b> Assign a Class of Service (1 ~ 15) to an extension.	Day Night/Mode: 1 ~ 8 Class of Service of Extensions (1 ~ 15)	Extension port 101 = Class 15 All other extension port = Class 1	✓		
20-07-01	<b>Class of Service Options (Administrator Level) – Manual Night Service Enabled</b> Turn Off or On an extension user ability to manually Switch the Night Mode (Service Code 718). This option must be enabled for an extension to display the Night indication.	0 = Off 1 = On	COS 1 ~ 14 = 0 COS 15 = 1		✓	
20-10-07	<b>Class of Service Options (Answer Service) – Automatic Off-Hook Answer</b> Turn Off or On an extension user ability to use Universal Auto Answer (no service code required).	0 = Off 1 = On	COS 1 ~ 15 = 0		✓	
22-02-01	<b>Incoming Call Trunk Setup</b> Assign the incoming trunk type for each trunk. There is one item for each Night Service Mode (1 ~ 8).	0 = Normal 1 = VRS (second dial tone if no VRS installed) 2 = DISA 3 = DID 4 = DIL 5 = E&M Tie line 6 = Delayed VRS 7 = ANI/DNIS 8 = DID(DDI) Mode Switching	0		✓	
22-04-01	<b>Incoming Extension Ring Group Assignment</b> To have trunks ring extensions during the different Night Service modes (for ANA), assign extensions to Ring Groups. For each extension in the Ring Groups (1 ~ 100), indicate in Program 22-06-01 if trunk should Ring (1) or Not Ring (0).	Maximum of eight digits.	Extensions 101 ~ 108 (first eight ports) ring for incoming Ring Group 1 calls. No other extensions ring for incoming Ring Group 1 calls.	✓		
22-05-01	<b>Incoming Trunk Ring Group Assignment</b> To have trunks ring extensions for ANA, assign trunks to Ring Groups (1 ~ 100), you make a different entry for each Night Service mode.	Trunks 1 ~ 400 Incoming Group Number for Day/Night Mode (1 ~ 8): 0 = (No Setting) 001 ~ 100 = (Incoming Group) 102 = (In-Skin/ External Voice Mail or InMail)	1	✓		

Program Number	Program Name/Description	Input Data	Default	Level		
				1	2	3
22-08-01	<b>DIL/IRG No Answer Destination</b> If a Universal Answer call rings longer than the DIL No Answer Time (Program 22-01-04), it routes to the Ring Group specified in this option.	0 = (No Setting) 001 ~ 100 = Incoming Ring Group 102 = (In-Skin/External Voice Mail or InMail)	1	✓		
31-05-01	<b>Universal Night Answer/Ring Over Page</b> For each Night Service Mode, assign which trunks should ring which External Paging Zones.	0 = No Ringing (No) 1 = Ringing (Yes)	0		✓	

## Operation

### To activate Night Service by dialing codes:

- At a multiline terminal, press **Speaker**.  
- OR -  
At the single line telephone, lift the handset.
- Dial **718**. To change a different group's mode, dial **718** + the group number (**01~32**).
- Dial the Night Service Code:  
1 = Day 1 Mode  
2 = Night 1 Mode  
3 = Midnight 1 Mode  
4 = Rest 1 Mode  
5 = Day 2 Mode  
6 = Night 2 Mode  
7 = Midnight 2 Mode  
8 = Rest 2 Mode
- Press **Speaker** or hang up.

### To activate Night Service by using programmable keys:

- Press **Night Service** key (Program 15-07-01 or SC 751:09 + Mode code number below).  
1 = Day 1 Mode  
2 = Night 1 Mode  
3 = Midnight 1 Mode  
4 = Rest 1 Mode  
5 = Day 2 Mode  
6 = Night 2 Mode  
7 = Midnight 2 Mode

8 = Rest 2 Mode

**To transfer a call to the Universal Answer External Page zones:**

1. Place the CO call on hold and dial the Transfer to Trunk Ring Group code (assigned in Program 11-15-09).
  - ◇ *You hear a confirmation tone.*
2. Hang up.
  - ◇ *The call rings over the External Paging, enabling anyone to answer the call.*



### Description

Off-Hook ringing alerts a multiline terminal user that an incoming outside call is ringing to that station during another call. Off-Hook Signaling helps important callers get through, without waiting in line for the called extension to become free. The system provides the following Off-Hook Signaling options:

- Called Extension Block**  
The called extension Class of Service may block incoming Off-Hook Signaling attempts. This is beneficial to users that do not want interruptions while on a call.
- Automatic Signaling**  
Calling a busy extension automatically initiates Off-Hook Signaling. This option is useful to receptionists, operators and others that must quickly process calls. This is set in the called extension Class of Service.
- Manual Signaling**  
After reaching a busy extension, manual signaling gives the caller the choice of using Off-Hook Signaling or activating other features. Extensions without automatic signaling have manual signaling. The users can dial a service code or press a Programmable Function Key to send Off-Hook Signaling to the called telephone.
- Selectable Off-Hook Signaling Mode**  
The Off-Hook Signal can be muted ringing, no off-hook ringing or a beep in the handset – based on the caller’s programming.
- Off-Hook Ringing**  
Use this option to enable or disable an extension Off-Hook Signaling for incoming calls. If enabled, Off-Hook Signaling occurs normally. If disabled, calls queue behind the extension busy line appearance and the user gets no Off-Hook Signaling indication. The second line appearance stays idle. The caller hears ringback tone while their call waits. This is set in the called extension Class of Service.
- DID Call Waiting**  
An extension can optionally have DID calls camp-on with Off-Hook/Call Wait signaling, without Off-Hook/Call Wait signaling or no signaling. This is set in the called extension Class of Service.
- Block Manual Off-Hook Signals**  
This Class of Service option enables/disables a busy extension ability to block off-hook signals manually sent from a co-worker. If disabled (not blocked), callers can dial \* at busy or busy/ring to signal the extension. If enabled (blocked), nothing happens when the caller dials \* to off-hook signal.

## ❑ Block Camp-On

If an extension has Block Camp-On enabled, callers to the extension cannot dial 2 to Camp-On after hearing busy or busy/ring. If the extension has Block Camp-On disabled, callers are not prevented from dialing 2 to Camp-On after hearing busy or busy/ring. This is set in the called extension Class of Service.

### Conditions

- An extension user cannot Camp-On to a busy extension or leave a callback if Off-Hook Signaling has already gone through. Off-Hook Signaling allows an extension to block a caller's ability to dial # to camp-on.
- You cannot send off-hook signals to an extension busy on a Handsfree (Speakerphone) call. The called extension large LED flashes fast, with no ringing.
- The setting of Program 20-13-06 affects the BLF display for Hotline and Reverse Voice Over. Refer to the features [Hotline on page 2-636](#) and [Reverse Voice Over on page 2-1351](#) for additional information.
- You cannot send off-hook signals to an extension that is already receiving a voice announcement.
- An extension user can store the Off-Hook Signaling Service Code (709) under a One-Touch Key to provide quick Off-Hook Signaling access.
- An extension set as Operator in Program 20-17-01 does not follow settings in Program 20-13-05, Program 20-13-06 or Program 20-09-07 and always receives Off-Hook Signaling.
- Program 20-09-07 and 20-13-06 must be set to 1 in Class of Service for a normal extension to receive automatic Off-Hook Signaling.
- Off-Hook signaling is supported for Wireless DECT (SIP) telephones.

### Default Settings

Enabled

## System Availability

### Terminals

All Multiline Terminals and Single Line Telephones

### Required Component(s)

None



## Related Features

- ➔ [Callback](#)
- ➔ [Call Waiting/Camp-On](#)
- ➔ [Direct Inward Dialing \(DID\)](#)
- ➔ [Handsfree and Monitor](#)
- ➔ [Hotline](#)
- ➔ [Intercom](#)
- ➔ [One-Touch Calling](#)
- ➔ [Programmable Function Keys](#)
- ➔ [Reverse Voice Over](#)
- ➔ [Single Line Telephones, Analog 500/2500 Sets](#)

## Guide to Feature Programming

The **Level 1**, **Level 2** and **Level 3** columns indicate the programs that are assigned when programming this feature in the order they are most commonly used. These levels are used with PCPro and WebPro wizards for feature programming.

- Level 1 – these are the most commonly assigned programs for this feature.
- Level 2 – these are the next most commonly assigned programs for this feature.
- Level 3 – these programs are not often assigned and require an expert level working knowledge of the system to be properly assigned.

Program Number	Program Name/Description	Input Data	Default	Level		
				1	2	3
11-12-03	<b>Service Code Setup (for Service Access) – Override (Off-Hook Signaling)</b> Assign a service code (709 by default) to be used for off-hook Signaling Override.	MLT, SLT 0 ~ 9, *, # Maximum of eight digits	709		✓	
11-16-04	<b>Single Digit Service Code Setup – Intercom Off-Hook Signaling</b> Assign a one-digit service code to be used for off-hook signaling.	Assign a one-digit service code to be used for off-hook signaling.	(default = *)		✓	

Program Number	Program Name/Description	Input Data	Default	Level		
				1	2	3
15-02-12	<b>Multiline Telephone Basic Data Setup – Off-Hook Ringing</b> For each extension, set off-hook Ringing type: 0 (muted), 1 (none), 3 (beep in speaker), 4 (beep in handset), 5 (Speaker & Handset Beep). DID, DNIS and DIL trunks can use any of the options – normal/ring group trunks can use only option 0 or 1.	0 = Muted Off-Hook Ringing 1 = No Off-Hook Ringing 2 = Not Used 3 = Beep in Speaker (SP) 4 = Beep in Handset (HS) 5 = Speaker & Handset Beep	5	✓		
15-07-01	<b>Programmable Function Keys</b> Assign a function key for off-hook Signaling (code 33).	Line Key 1 ~ 48 0 ~ 99 (Normal Function Code 751 by default) *00 ~ *99 (Appearance Function Code) (Service Code 752 by default)	Refer to the Programming Manual for default values.	✓		
20-06-01	<b>Class of Service for Extensions</b> Assign a Class of Service (1 ~ 15) to an extension.	Day Night/Mode: 1 ~ 8 Class of Service of Extensions (1 ~ 15)	Extension port 101 = Class 15 All other extension port = Class 1	✓		
20-09-07	<b>Class of Service Options (Incoming Call Service) – Call Queuing</b> Turn Off or On an extension ability to have calls queued if a call rings the extension when it is busy. ➤ <i>Must be set to 1 to enable automatic off-hook Signaling.</i> ➤ <i>Program 20-13-06 must be set to 0 (Off) for this feature to work.</i>	0 = Off 1 = On	COS 1 ~ 15 = 1	✓		
20-13-05	<b>Class of Service Options (Supplementary Service) – Intercom Off-Hook Signaling</b> Turn Off or On an extension user ability to send Off-Hook Signals. ➤ <i>This setting functions with Programs 20-09-07 and 20-13-06 disabled.</i>	0 = Off 1 = On	COS 1 ~ 15 = 1	✓		
20-13-06	<b>Class of Service Options (Supplementary Service) – Automatic Off-Hook Signaling (Automatic Override)</b> Allow a busy extension to Automatically (1) or Manually (0) receive off-hook Signals. ➤ <i>This setting is to receive incoming call signaling information during call queuing.</i>	0 = Off 1 = On	COS 1 ~ 15 = 1	✓		
20-13-34	<b>Class of Service Options (Supplementary Service) – Block Manual Off-Hook Signaling</b> Turn Off or On an extension user ability to block off-hook signals manually sent from a co-worker.	0 = Off 1 = On	COS 1 ~ 15 = 0		✓	
20-18-06	<b>Service Tone Timers – Interval of Call Waiting Tone</b> Set the time between off-hook Signaling alerts.	0 ~ 64800 seconds	10		✓	

Program Number	Program Name/Description	Input Data	Default	Level		
				1	2	3
80-01-01 (39)	<b>Service Tone Setup – Repeat Count</b> Customize the system basic tones and system service tones. The system must be reset for the changes to take affect.		Refer to <a href="#">Table 2-33 Service Tone Setup Defaults, Program 80-01-01</a> on page 2-594.			✓
80-01-02 (39)	<b>Service Tone Setup – Basic Tone Number</b> The following features require that the system tones listed below be changed to match the table. After changing these settings the chassis must be reset for the changes to take effect. <ul style="list-style-type: none"> <li>○ Call Screening</li> <li>○ Call Holding</li> <li>○ Busy Greeting</li> <li>○ Await Answer Transfer</li> </ul>		Refer to <a href="#">Table 2-34 Service Tone Setup, Program 80-01-02</a> on page 2-598.			✓

## Operation

### To send Off-Hook signals to an extension busy on a call:



NOTE

*Your extension may send off-hook signals automatically.*

1. Dial 7.

**- OR -**

Press **Off-Hook Signaling** key (Program 15-07 or SC 751: 33).

- ◇ *You hear ringback.*
- ◇ *To have your call voice-announce, dial 1.*

### Receiving Off-Hook Signaling on a single line telephone while engaged on an internal or external call:

1. When Off-Hook Signaling is heard in the receiver, press the **Flash** Key to answer the call. The first call is placed on hold.
2. Press the **Flash** Key again to toggle between the two calls.
  - ◇ *If the single line phone hangs up with the active call, the other call on hold rings back to the single line.*

## One-Touch Calling

### Description

One-Touch Calling gives a multiline terminal user one-button access to extensions, trunks, speed dial bins and selected system features. This saves users time when accessing co-workers, clients and features they use most often. Instead of dialing a series of codes, the user need only press the One-Touch key. An extension user can have One-Touch keys programmed for:

- Direct Station Selection – one-button access to extensions
- Station Speed Dial – one-button access to stored numbers (up to 24 digits long)
- Speed Dial - System/Group/Station – one-button access to stored speed dialing numbers
- Trunk Calling – one-button access to trunks or trunk groups
- Service Codes – one-button access to specific Service Codes

An extension user can chain dial with One-Touch Keys. For example, a user can store the number for a company Automated Attendant in key 1 and employee extension numbers in keys 2~5. The user presses key 1 to call the company, then one of keys 2~5 to ring the employee to which they want to speak.

An extension user or system administrator can optionally store a Flash command under a One-Touch key. This is helpful for One-Touch Keys used as Station Speed Dial bins. The stored Flash may be helpful to access features of the connected Telco, PBX or Centrex.

### Conditions

- One-Touch keys provide a Busy Lamp Field (BLF).
- When a multiline terminal user is on a call, they can transfer to another station by pressing a DSS key for that station. It is not necessary to press Transfer to transfer to another station using a DSS key.
  - ◇ *When a multiline terminal user is on a call, they must press transfer to transfer a call off site with a DSS key.*
  - ◇ *When a multiline terminal user is on a call, they must press transfer to transfer a call to a destination that is not a station (/Voice Mail/Department group pilot, etc.).*
- Pauses can be entered in the dial string of a DSS/One Touch button. The pause is entered as P in the dial string and causes the system to wait three seconds before sending the rest of the digits that follow the P (pause). Multiple pauses can be entered.
- The @ can be entered in the dial string of a DSS/One Touch button. The @ only applies to ISDN and Intercom calls. When using the @, the system waits for the destination to answer (answer supervision), and then sends the rest of the digits.

- Entering a P (pause) in a DSS/One Touch dial string can be used for CO calls or after the @ for ISDN calls.
- ARS with Max Digits is not supported when entering the @ or a P (pause) in the dial string of a DSS/One Touch button.

### Default Setting

None

## System Availability

### Terminals

All Multiline Terminals and DSS Consoles

### Required Component(s)

None

## Related Features

↪ **Programmable Function Keys**

↪ **Transfer**

## Guide to Feature Programming

The **Level 1**, **Level 2** and **Level 3** columns indicate the programs that are assigned when programming this feature in the order they are most commonly used. These levels are used with PCPro and WebPro wizards for feature programming.

- Level 1 – these are the most commonly assigned programs for this feature.
- Level 2 – these are the next most commonly assigned programs for this feature.
- Level 3 – these programs are not often assigned and require an expert level working knowledge of the system to be properly assigned.

Program Number	Program Name/Description	Input Data	Default	Level		
				1	2	3
15-07-01	<b>Programmable Function Keys</b> Define a Programmable Function Key for One-Touch Calling by defining the key as a DSS/One-Touch key (01).	Line Key 1 ~ 48 0 ~ 99 (Normal Function Code 751 by default) *00 ~ *99 (Appearance Function Code) (Service Code 752 by default)	Refer to the Programming Manual for default values.	✓		
11-11-17	<b>Service Code Setup (for Setup/Entry Operation) – Programmable Function Key Programming (2-Digit Service Codes)</b> Set the service code (default 751) to assign 2-digit function codes to the Function keys.	MLT 0 ~ 9, *, # Maximum of eight digits	751		✓	
20-13-18	<b>Class of Service Options (Supplementary Service) – Programmable Function Key Programming (General Level)</b> Turn Off or On an extension user ability to program General function keys using Service Code 751 (by default). (Refer to Program 20-07-10 for Service Code 752.)	0 = Off 1 = On	COS 1 ~ 15 = 1		✓	
30-03-01	<b>DSS Console Key Assignment</b> Customize DSS Console keys to function as DSS keys, Service Code keys, Programmable Function Keys and One-Touch Calling keys. When programming a feature within a One-Touch Key, refer to the feature description for additional programming options.	Key Number 001 ~ 114 0 ~ 99 (General Functional Level) 97 = Door Box Access key (additional data: 1 ~ 8 Door Box No.) *00 ~ *99 (Appearance Functional Level)	Refer to the Programming Manual for default values.		✓	

## Operation

### Programmable Function Keys

#### To define a Programmable Function Key as a One-Touch Key:

1. Dial the service code for Function Key Programming (Program 11-11-17, 751 by default).
2. Press the key to be defined.
3. Dial **01** (DSS/One-Touch Key Operation).
4. For Direct Station Selection (Extension):
  - a. Dial extension number you want assigned to that key.
  - b. Press **Hold**.
  - c. Press **Speaker**.

For Personal Speed Dial:

- a. Dial the general trunk access code (**9**).  
- **OR** -  
Dial the Specific Trunk Service Code (**#9**) plus the trunk number (e.g., 005).  
- **OR** -  
Dial the Trunk Group Service Code (**704**) plus the trunk group number (e.g., 1).
- b. Dial the number you want to store.
  - ◇ *The total of the digits stored in steps 3 and 4 cannot exceed 24.*
  - ◇ *Valid entries are 0-9, # and \*. To enter a pause, press **MIC**. To store a Flash, press **Redial**.*
- c. Press **Hold**.
- d. Press **Speaker**.

For Speed Dial – System/Group:

- a. Dial **#2** to store a Speed Dial – System dialing number.  
- **OR** -  
Dial **#4** to store a Speed Dial – Group dialing number.
- b. Dial Speed Dial number storage code (e.g., 001).
- c. Press **Hold**.
- d. Press **Speaker**.

For Central Office Calls, Placing (Trunk Calling):

- a. Dial the general trunk access code (**9**).  
- **OR** -  
Dial the specific Trunk Service Code (**#9**) plus the trunk number (e.g., 005).  
- **OR** -  
Dial the Trunk Group Service Code (**704**) plus the trunk group number (e.g., 1).
- b. Dial the telephone number to be stored.
- c. Press **Hold**.
- d. Press **Speaker**.

For Service Codes:

- a. Dial the Service Code you want stored.
  - ◇ *For example, if you want a One-Touch Key to automatically clear your Last Number Redial, enter 776.*
- b. Press **Hold**.
- c. Press **Speaker**.

## Checking the One-Touch Keys

### To check the function of a One-Touch key:

1. Press the **Help** key.

2. Press the **One-Touch** key.
  - ◇ *The stored function displays.*
  - ◇ *Repeat this step to check additional keys.*
3. Press the **Exit** key.



## Operator

### Description

When an extension user dials 0, calls are routed to a main system operator. The operator can answer and route outside calls or locate employees using the Page feature.

A maximum of eight operators is available.

#### Conditions

- Attendant extensions can have up to 32 incoming calls queued before additional callers hear busy tone.
- The operator extension cannot be a CAR Key or virtual extension.
- When dialing 0 from the in-skin Voice Mail across CCIS and CCISoIP, it follows what is in the operator set up.
- Extensions and trunks can be assigned to an operator group. A call to an operator that is busy rolls to the next operator in the operator group.

#### Default Settings

Extension 101 is an operator.

### System Availability

#### Terminals

All Terminals

#### Required Component(s)

None

### Related Features

↳ [Attendant Call Queuing](#)

## Guide to Feature Programming

The **Level 1**, **Level 2** and **Level 3** columns indicate the programs that are assigned when programming this feature in the order they are most commonly used. These levels are used with PCPro and WebPro wizards for feature programming.

- Level 1 – these are the most commonly assigned programs for this feature.
- Level 2 – these are the next most commonly assigned programs for this feature.
- Level 3 – these programs are not often assigned and require an expert level working knowledge of the system to be properly assigned.

Program Number	Program Name/Description	Input Data	Default	Level		
				1	2	3
20-01-01	<b>System Options – Operator Access Mode</b> Set up priority of a call when calling an operator telephone (0 = Step, 1 = Circular).	0 = Step 1 = Circular	0	✓		
20-17-01	<b>Operator Extension – Operator’s Extension Number</b> Designate an extension an operator. When an extension user dials 0 or 9 (defined by Program 11-01, Type 5), calls go to the operator selected in this program. If you do not assign an extension in Program 90-11-01, system alarms appear on the extension assigned in this option.	Maximum of eight digits.	101		✓	
20-35-01	<b>Extension’s Operator Setting</b> Assign an extension to an operator group.	0 ~ 15	0		✓	
20-36-01	<b>Trunk’s Operator Setting</b> Allow the user to select Operator Group per trunk.	0 ~ 15 (0 = Not assigned)	0		✓	
20-37-01	<b>Operator Extension Group Setup</b> Define the initial operator extension in the operator group.	0 ~ 9, *, # Maximum of eight digits	No Setting		✓	
20-38-01	<b>Operator Group Setting – Operator Access Mode</b> Set up priority of a call when calling an operator telephone.	0 = Step 1 = Circular	0		✓	

## Operation

Refer to the individual features for operation.

## (OPX) Off-Premise Extension

### Description

Off-Premise Extension allows a single line telephone, located remotely from the main installation site, to access the system features with the same abilities as an on-premise single line telephone.

#### Conditions

- Each GCD-4DIOPA provides four off-premise circuits.
- The maximum loop resistance between a GCD-4DIOPA and an Off-Premise Extension Single Line Telephone is 1600ohms (including single line telephone set resistance).
- The GCD-4DIOPA has a built-in ringer (RSG). This blade supports Synchronous Ringing and detects Dial Pulse/DTMF tones.
- The GCD-4DIOPA does not support an interface to a Voice Mail unit.

#### Default Settings

None

### System Availability

#### Terminals

Single Line Telephones

#### Required Component(s)

GCD-4DIOPA

### Related Features

➔ [Single Line Telephones, Analog 500/2500 Sets](#)

## Guide to Feature Programming

The **Level 1**, **Level 2** and **Level 3** columns indicate the programs that are assigned when programming this feature in the order they are most commonly used. These levels are used with PCPro and WebPro wizards for feature programming.

- Level 1 – these are the most commonly assigned programs for this feature.
- Level 2 – these are the next most commonly assigned programs for this feature.
- Level 3 – these programs are not often assigned and require an expert level working knowledge of the system to be properly assigned.

◇ Refer to [Single Line Telephones, Analog 500/2500 Sets on page 2-1449](#) for related programming.

Program Number	Program Name/Description	Input Data	Default	Level		
				1	2	3
10-03-01	<b>ETU Setup</b> Set up and confirm the basic configuration data for each blade. This program represents different data depending on the blade installed in the slot. Refer to the SV9100 Programming Manual for a more detailed description of this program.	The assigned data varies depending on the blade installed in the slot.	Refer to the Programming Manual for default values for a more detailed description of the 10-03-XX programs.		✓	
10-09-01	<b>DTMF and Dial Tone Circuit Setup</b> Allocate the circuits on the GCD-CP10 ETUs for either DTMF receiving or dial tone detection. Program 14-01-13 Basic Trunk Data Setup – Loop Supervision Enable (1) loop supervision for each trunk that should be able to use Call Forwarding – Centrex.	0 = Common Use 1 = Extension Only 2 = Trunk Only	Circuit/Resource 01 ~ 08 = 1 (Extensions) Circuit/Resource 09 ~ 32 = 2 (Trunks) Circuit/Resource 33 ~ 144 = 0 (Common) When GPZ-BS10 is installed, 81 ~ 144 are available		✓	
15-03-01	<b>Single Line Telephone Basic Data Setup – SLT Signaling Type</b> Select the type of dialing the connected telephone uses. For the UNIVERGE SV9100 Wireless telephones to function correctly, this must be set to 0. If this option is set for DTMF, after an outside call is placed, the system cannot dial any additional digit. This program change is automatically performed when the UNIVERGE SV9100 Wireless telephone is registered. When upgrading software from prior versions, the previous default of 1 is saved from the prior database so this option must be changed manually.	0 = DP 1 = DTMF	1		✓	

Program Number	Program Name/Description	Input Data	Default	Level		
				1	2	3
15-03-03	<b>Single Line Telephone Basic Data Setup – Terminal Type</b> Enter 1 for this option to allow a single line port to receive DTMF tones after the initial call setup. Enter 0 to have the port ignore DTMF tones after the initial call setup. For Voice Mail, always enter 1 (e.g., receive DTMF tones).	0 = Normal 1 = Special	0		✓	
15-03-05	<b>Single Line Telephone Basic Data Setup – Trunk Polarity Reverse</b> -- Not Used in U.S. -- Do Not Change Default Entry as DTMF issues may arise with voice mail.	0 = Off 1 = On	0		✓	
15-03-06	<b>Single Line Telephone Basic Data Setup – Extension Polarity Reverse</b> -- Not Used in U.S. -- Do Not Change Default Entry as DTMF issues may arise with voice mail.	0 = Disable (Off) 1 = Enable (On)	0		✓	
15-03-07	<b>Single Line Telephone Basic Data Setup – Enabled On-Hook When Holding (SLT)</b> Enable/Disable this program.	0 = No 1 = Yes	1		✓	
15-03-08	<b>Single Line Telephone Basic Data Setup – Answer On-Hook when Holding (SLT)</b> Enable/Disable Answer on-hook when Holding for SLT.	0 = Disable (No) 1 = Enable (Yes)	1		✓	
15-03-09	<b>Single Line Telephone Basic Data Setup – Caller ID Function - For External Module</b> Enable/Disable the Caller ID FSK signal for an external Caller ID module or a 3rd-Party vendor telephone with Caller ID display. <b>Important:</b> If voice mail is used, this setting must be disabled for the system integration codes to be correct. ➡ <i>With a 2500 set (no Caller ID) installed, this must be set to 0 for incoming callers to have a talk path.</i>	0 = Disable 1 = Enable	0		✓	
15-03-10	<b>Single Line Telephone Basic Data Setup – Caller ID Name</b> Determine if an extension user telephone should display the Caller ID name.	0 = Disable 1 = Enable	1		✓	
15-03-11	<b>Single Line Telephone Basic Data Setup – Caller ID Type</b> Select whether the Caller ID type is FSK or DTMF.	0 = FSK 1 = DTMF	0		✓	
15-03-14	<b>Single Line Telephone Basic Data Setup – Forwarded Caller ID Display Mode</b> Determine what the display shows when a multiline terminal receives a forwarded outside call.	0 = Calling Extension Number (Calling) 1 = External Caller ID (Forward)	0		✓	

Program Number	Program Name/Description	Input Data	Default	Level		
				1	2	3
20-03-01	<p><b>System Options for Single Line Telephones – SLT Call Waiting Answer Mode</b></p> <p>For a busy single line (500/2500 type) telephone, set the mode used to answer a camped-on trunk call.</p> <p>For ESL sets, enabling this option (1) allows the user to dial Service Code for Voice Mail Conversation Record.</p>	<p>0 = Hookflash (Hooking)                      1 = Hookflash + Service Code 794</p> <p>➡ <i>Service Code 654 is for Live Recording at SLT (Program 11-12-53).</i></p>	0		✓	
20-03-02	<p><b>System Options for Single Line Telephones – Ignore Received DP Dial on DTMF SLT Port</b></p> <p>Define whether the system should receive dial pulse and DTMF signals (0) or ignore dial pulse and only accept DTMF signals (1).</p>	<p>0 = Do Not Ignore (No)                      1 = Ignore (Yes)</p>	0		✓	
20-03-03	<p><b>System Options for Single Line Telephones – SLT DTMF Dial to Trunk Lines</b></p> <ul style="list-style-type: none"> <li>○ <b>Type 0:</b> The system keeps the digits dialed by the single line telephone on a trunk in a buffer. After they are received, the system sends all the digits to the trunk. If the time space between digits is longer than the time in Program 20-03-04, the system considers all digits received.</li> <li>○ <b>Type 1:</b> The system passes the received digits from the single line telephone to the trunk immediately. If the single line telephone has a Last Number Dial key without a pause, this key may not be able to use the Last Number Dial key with the Type 1 setting.</li> </ul> <p>When using a third-party external paging device, set this option to <b>1</b>. In addition, set Program 20-03-04 to <b>1</b>. These programs must be set for Wireless DECT (SIP) users to break dial tone on an analog trunk that is used for paging.</p>	<p>0 = Receive all dialed data, before sending (All)                      1 = Direct through out (Direct)</p>	0		✓	
20-03-04	<p><b>System Options for Single Line Telephones – Dial Sending Start Time for SLT or ARS</b></p> <p>When ARS or an analog extension user accesses a trunk and dials an outside call, the system waits this interval before outdialing the first digit.</p>	0 ~ 64800 seconds	3		✓	
20-03-05	<p><b>System Options for Single Line Telephones – SLT Operation Mode</b></p> <p>Set the operation mode for single line telephones.</p>	<p>0 = Normal Mode                      1 = Extended Mode1                      2 = Extended Mode2</p>	0		✓	
20-03-06	<p><b>System Options for Single Line Telephones – Headset Ringing Start Time (for SLT)</b></p> <p>Define the headset ringing start time. After this time expires after a single line telephone is off-hook, the system sets the single line telephone to headset ringing mode.</p>	0 ~ 64800 seconds	5		✓	

Program Number	Program Name/Description	Input Data	Default	Level		
				1	2	3
20-03-07	<b>System Options for Single Line Telephones – Trunk Call Dial Forced Sending Start Time (Forced Dial)</b> Define the Trunk Call Dial Forced Sending Start Time (Forced Dial) for single line telephones.	0 ~ 64800 seconds	0		✓	
20-06-01	<b>Class of Service for Extensions</b> Assign a Class of Service (1 ~ 15) to an extension.	Day Night/Mode: 1 ~ 8 Class of Service of Extensions (1 ~ 15)	Extension port 101 = Class 15 All other extension port = Class 1		✓	
20-13-13	<b>Class of Service Options (Supplementary Service) – Continued Dialing (DTMF) Signal on ICM Call</b> Turn Off or On an extension user ability to use Continued Dialing, which allows DTMF signal sending while talking on extension.	0 = Off 1 = On	COS 1 ~ 15 = 1		✓	
20-15-01	<b>Ring Cycle Setup – Normal Incoming Call on Trunk</b> Define the ring cycle for Incoming Internal calls.	Ring Cycle = 1 ~ 13	2		✓	
20-15-03	<b>Ring Cycle Setup – Incoming Internal Call</b> Define the incoming internal call ringing cycles for each ring type.	Ring Cycle = 1 ~ 13	12		✓	
20-15-05	<b>Ring Cycle Setup – DID/DDI</b> Define the ring cycle for DID/DDI calls.	Ring Cycle = 1 ~ 13	8		✓	
80-03-01	<b>DTMF Tone Receiver Setup – Detect Level</b> Use Items 11 ~ 32 to set the criteria for dial tone detection for outgoing ARS calls.	0 = 0dBm ~ -25dBm 1 = -5dBm ~ -30dBm 2 = -10dBm ~ -35dBm 3 = -15dBm ~ -40dBm 4 = -20dBm ~ -45dBm 5 = -25dBm ~ -50dBm 6 = -30dBm ~ -55dBm	Type 1 ~ 5 = 0			✓
80-03-02	<b>DTMF Tone Receiver Setup – Start Delay Time</b> Define the start delay time for DTMF Tone Receiver.	0 ~ 255 (0.25ms ~ 64ms)	Type 1 ~ 5 = 0			✓

Program Number	Program Name/Description	Input Data	Default	Level		
				1	2	3
80-03-03	<b>DTMF Tone Receiver Setup – Min. Detect Level</b> Define the minimum detection level for DTMF Tone Receiver.	0 ~ 15 detect level 0: -10dBm(0) to -25dBm(15) detect level 1: -15dBm(0) to -30dBm(15) detect level 2: -20dBm(0) to -35dBm(15) detect level 3: -25dBm(0) to -40dBm(15) detect level 4: -30dBm(0) to -45dBm(15) detect level 5: -35dBm(0) to -50dBm(15) detect level 6: -40dBm(0) to -55dBm(15) detect level 7: -45dBm(0) to -60dBm(15) detect level 8: -50dBm(0) to -65dBm(15) detect level 9: -55dBm(0) to -70dBm(15) detect level 10: -60dBm(0) to -75dBm(15) detect level 11: -65dBm(0) to -80dBm(15) detect level 12: -70dBm(0) to -85dBm(15) detect level 13: -75dBm(0) to -90dBm(15) detect level 14: -80dBm(0) to -95dBm(15) detect level 15: -85dBm(0) to -100dBm(15)	Type 1 = 10 (-20dBm) Type 2 ~ 3 = 15 (-25dBm) Type 4 ~ 5 = 10 (-20dBm)			✓



Program Number	Program Name/Description	Input Data	Default	Level		
				1	2	3
80-03-04	<b>DTMF Tone Receiver Setup – Max. Detect Level</b> Define the maximum detection level for DTMF Tone Receiver.	0 ~ 15 detect level 0: 0dBm(0) to -15dBm(15) detect level 1: -5dBm(0) to -20dBm(15) detect level 2: -10dBm(0) to -25dBm(15) detect level 3: -15dBm(0) to -30dBm(15) detect level 4: -20dBm(0) to -35dBm(15) detect level 5: -25dBm(0) to -40dBm(15) detect level 6: -30dBm(0) to -45dBm(15) detect level 7: -35dBm(0) to -50dBm(15) detect level 8: -40dBm(0) to -55dBm(15) detect level 9: -45dBm(0) to -60dBm(15) detect level 10: -50dBm(0) to -65dBm(15) detect level 11: -55dBm(0) to -70dBm(15) detect level 12: -60dBm(0) to -75dBm(15) detect level 13: -65dBm(0) to -80dBm(15) detect level 14: -70dBm(0) to -85dBm(15) detect level 15: -75dBm(0) to -90dBm(15)	Type 1 ~ 5 = 2 (-2dBm)			✓
80-03-05	<b>DTMF Tone Receiver Setup – Forward Twist Level</b> Define the forward twist level for DTMF Tone Receiver.	0 ~ 9 (1dB ~ 10dB)	Type 1 = 5 (6dBm) Type 2 = 5 (6dBm) Type 3 = 5 (6dBm) Type 4 = 5 (6dBm) Type 5 = 5 (6dBm)			✓

Program Number	Program Name/Description	Input Data	Default	Level		
				1	2	3
80-03-06	<b>DTMF Tone Receiver Setup – Backwards Twist Level</b> Define the backwards twist level for DTMF Tone Receiver.	0 ~ 9 (1dB ~ 10dB)	Type 1 = 0 (1dBm) Type 2 = 0 (1dBm) Type 3 = 0 (1dBm) Type 4 = 0 (1dBm) Type 5 = 0 (1dBm)			✓
80-03-07	<b>DTMF Tone Receiver Setup – ON Detect Time</b> Define the On detection time for DTMF Tone Receiver.	1 ~ 255 (15+ 15ms ~ 3825ms)	<b>Version 1000</b> Type 1 ~ 5 = 1 (30ms)			✓
			<b>Version 3000 or higher</b> Type 1 ~ 5 = 3 (60ms)			
80-03-08	<b>DTMF Tone Receiver Setup – OFF Detect Time</b> Define the Off detection time for DTMF Tone Receiver.	1 ~ 255 (15+ 15ms ~ 3825ms)	<b>Version 1000</b> Type 1 ~ 5 = 1 (30ms)			✓
			<b>Version 3000 or higher</b> Type 1 ~ 5 = 2 (45ms)			
80-04-04	<b>Call Progress Tone Detector Setup – No Tone Time</b> Define the no tone time for the Call Progress Tone Detector.	0 ~ 255 (30 + 30 ~ 7680ms) (0 = not detect) 1 ~ 255 = 60 ~ 7680ms The formula is 30 + 30N. When set to N = 1, it means 30 + 30 * 1 = 60. When set to N=255, it means 30+30*255=7680	Type 1 (DT) – 132 (3990ms) Type 2 (BT) – 132 (3990ms) Type 3 (RBT) – 132 (3990ms) Type 4, Type 5 – 0			✓
82-11-01	<b>LCA Initial Setup – Bounce Protect Time</b> Specify a time for detection of a valid Off-Hook indication that is long enough to prevent an unintentional bounce of the receiver from being detected as a new off-hook indication from a single line telephone.	0 = No Setting 1 ~ 15 = 100ms ~ 1.5sec	3			✓
82-11-02	<b>LCA Initial Setup – HookFlash Start Time</b> Specify the minimum hookflash time from a Single Line Telephone or analog Voice Mail system before it is detected as the beginning of a valid hookflash.	0 = 40ms 1 ~ 15 = 90ms ~ 790ms	5			✓
82-11-03	<b>LCA Initial Setup – HookFlash End Time</b> Specify the maximum hookflash duration from a Single Line Telephone to receive a second dial tone.	0 = HST+0ms 1 ~ 15 = HST+100ms ~ HST+1500ms (HST = Hookflash Start Time)	7			✓

## Operation

Normal call handling procedures for single line telephones apply.



### Description

With External Paging, a user can broadcast announcements over paging equipment connected to external Paging zones. When a user pages one of these external zones, the system broadcasts the announcement over the speakers. Like Internal Paging, External Paging allows a user to locate another employee or make an announcement without calling each extension individually.

The UNIVERGE SV9100 system allows up to eight External Paging zones, or a common zone output provided by the CPU (Speaker 9). All other speakers (1~8) require a port on a PGD(2)-U10 ADP, with a maximum of two external paging circuits per module. You must have four PGD(2)-U10 ADPs to get the eight external zones. In addition, each external zone has an associated relay contact. When a user pages to a zone, the corresponding contact activates (closes). This provides for Paging amplifier control.

### Combined Paging

Use Combined Paging when you want to simultaneously Page into an internal and corresponding external zone. For example, you can Page your company warehouse and outside loading dock at the same time. Combined Paging is available for zones 1~8 and All Call. Refer to [Paging, Internal on page 2-1267](#) for more on setting up Combined Paging. In addition, you can program a Function Key as a Combined Paging key. Using the External Page Function Key, when an All Call External Page Function Key is programmed, it includes both the external zones and the assigned internal zone(s). If the internal page zone is busy or there are no extensions in a page group, the announcement is made on the external zones only.

### Conditions

- The UNIVERGE SV9100 provides a common zone output provided by the chassis. For more than one external page zone, External Paging requires PGD(2)-U10 ADPs and customer-provided paging equipment.
- Talkback paging requires the use of a PGD(2)-U10 ADP. The UNIVERGE SV9100 common zone output provided by the chassis does not allow talkback.
- A common zone output is provided by the chassis and is considered Zone 9 when programming.
- A Class of Service option is available in system programming to prevent display telephones from showing incoming paging information. This allows the system to save processor time and speed up system operation.
- DID and DIL trunks do not ring external page speakers. Only trunks defined as normal in Program 22-02-01 ring external page speakers.

- Paging keys can be assigned on Programmable Function Keys and Direct Station Selection (DSS) Consoles to simplify External Paging operation.
- If a PGD(2)-U10 ADP circuit has a Door Box connected, you cannot use that circuit for External Paging.
- To have outside calls ring External Paging Zones at night, refer to the Night Service feature and Program 31-05.
- The PGD(2)-U10 ADP can be connected only to a DLC.
- The maximum number of PGD(2)-U10 ADP is 56. Refer to the Hardware Manual for more information which describes how many of the 56 can be for paging, door box or Music on Hold (MOH).
- Phones that have an APR/APA installed do not pass voice to a trunk used for paging until the interdigit timer expires (Program 21-01-03).
- If a Central Office (CO) trunk port is used for external paging, a Multiline Terminal with an AP(A)-R Unit installed does not provide a speech path to the paging system.
- The PGD(2)-U10 ADP can not send DTMF to External Paging equipment.

## Default Settings

None

## System Availability

### Terminals

All Terminals

### Required Component(s)

- GCD-8DLCA, GCD-16DLCA or GCD-LTA for PGD(2)-U10 ADP
- PGD(2)-U10 ADP for Zone Paging
- 1- or 2-way amplifier and speakers (locally provided)

## Related Features

- ➔ **Central Office Calls, Placing**
- ➔ **Direct Inward Dialing (DID)**
- ➔ **Direct Inward Line (DIL)**

- ➔ [Direct Station Selection \(DSS\) Console](#)
- ➔ [Door Box](#)
- ➔ [Night Service](#)
- ➔ [Paging, Internal](#)
- ➔ [Programmable Function Keys](#)
- ➔ [Transfer](#)

## Guide to Feature Programming

The **Level 1**, **Level 2** and **Level 3** columns indicate the programs that are assigned when programming this feature in the order they are most commonly used. These levels are used with PCPro and WebPro wizards for feature programming.

- Level 1 – these are the most commonly assigned programs for this feature.
- Level 2 – these are the next most commonly assigned programs for this feature.
- Level 3 – these programs are not often assigned and require an expert level working knowledge of the system to be properly assigned.

Program Number	Program Name/Description	Input Data	Default	Level		
				1	2	3
10-05-01	<b>General Purpose Relay Setup – Slot No. Physical Port of DLCA Sensor Circuit No.</b> Define which relay circuits (5 ~ 8) on the PGD(2)-U10 ADP are used for General Purpose Relays.	Slot No: 0 ~ 24 DCLA Port: 0 ~ 16 Relay No: 0, 5 ~ 8 ➤ <i>After each entry, press Transfer to advance to the next entry.</i>	0 - 0 - 0	✓		
10-21-04	<b>GCD-CP10 Hardware Setup – External Source I/O Selection on GCD-CP10</b> Define how the I/O ports on the GCD-CP10 are used.	0 = External MOH (AUX2)/ External Speaker(AUX1) 1 = BGM source (AUX2)/ External Speaker(AUX1) 2 = External MOH (AUX2)/ BGM source (AUX1) ➤ <i>Relationships between AUX number and Relay number are as follows:</i> AUX2 = Relay2 AUX1 = Relay1	1		✓	
11-12-50	<b>Service Code Setup (For Service Access) – General Purpose Relay</b> Specify the service code used to toggle the relay open and closed.	MLT, SLT 0 ~ 9, *, # Maximum of eight digits	780		✓	

Program Number	Program Name/Description	Input Data	Default	Level		
				1	2	3
15-07-01	<b>Programmable Function Keys</b> Assign function keys for External Paging zones (19 + zone) and External All Call Page (20). If required, define a function key for a multiline terminal to use the general purpose relay (51).	Line Key 1 ~ 48 0 ~ 99 (Normal Function Code 751 by default) *00 ~ *99 (Appearance Function Code) (Service Code 752 by default)	Refer to the Programming Manual for default values.	✓		
20-06-01	<b>Class of Service for Extensions</b> Assign a Class of Service (1 ~ 15) to an extension.	Day Night/Mode: 1 ~ 8 Class of Service of Extensions (1 ~ 15)	Extension port 101 = Class 15 All other extension port = Class 1	✓		
20-13-29	<b>Class of Service Options (Supplementary Service) – Paging Display</b> Turn Off or On an extension user ability to display paging information.	0 = Off 1 = On	COS 1 ~ 15 = 1		✓	
31-01-02	<b>System Options for Internal/External Paging – Page Announcement Duration</b> Set the maximum allowable duration for a Paging announcement.	0 ~ 64800 seconds	1200		✓	
31-03-01	<b>Internal Paging Group Settings – Internal Paging Group Name</b> Assign name to Internal Paging Groups (i.e., Page Zones). The system shows the name you program on the telephone display.	Maximum of 12 characters.	Refer to the Programming Manual for default values.		✓	



Program Number	Program Name/Description	Input Data	Default	Level		
				1	2	3
31-04-01	<p><b>External Paging Zone Group</b></p> <p>Assign each External Paging Speaker to an External Paging Group (1 ~ 8) used for accessing the zone. If zones 1 ~ 8 are not connected to PGD(2)-U10 ADP, set these unused zones to External Paging Group 0.</p>	0 ~ 8 (0 = No Setting)	<p>Speaker 1 [PGD(2)-U10] = 1 (Group 1)</p> <p>Speaker 2 [PGD(2)-U10] = 2 (Group 2)</p> <p>Speaker 3 [PGD(2)-U10] = 3 (Group 3)</p> <p>Speaker 4 [PGD(2)-U10] = 4 (Group 4)</p> <p>Speaker 5 [PGD(2)-U10] = 5 (Group 5)</p> <p>Speaker 6 [PGD(2)-U10] = 6 (Group 6)</p> <p>Speaker 7 [PGD(2)-U10] = 7 (Group 7)</p> <p>Speaker 8 [PGD(2)-U10] = 8 (Group 8)</p> <p>Speaker 9 (GCD-CP10) = 1 (Group 1)</p>	✓		
31-05-01	<p><b>Universal Night Answer/Ring Over Page</b></p> <p>Assign Universal Night Answer ringing to each External Paging zone. For each trunk port, make a separate entry for each External Paging Speaker.</p>	<p>External Paging Speaker/Zones: 1 ~ 9</p> <p>0 = No Ringing (No)</p> <p>1 = Ringing (Yes)</p>	0		✓	
31-06-01	<p><b>External Speaker Control – Broadcast Splash Tone before Paging (Paging Start Tone)</b></p> <p>Enable/Disable splash tone before Paging over an external zone. If enabled, the system broadcasts a splash tone before the External Paging announcement.</p>	<p>0 = No Tone (None)</p> <p>1 = Splash Tone</p> <p>2 = Chime Tone</p>	2		✓	
31-06-02	<p><b>External Speaker Control – Broadcast Splash Tone after Paging (Paging End Time)</b></p> <p>Assign option for each External Paging Speaker (1 ~ 9).</p>	<p>0 = No Tone (None)</p> <p>1 = Splash Tone</p> <p>2 = Chime Tone</p>	2		✓	
31-06-04	<p><b>External Speaker Control – CODEC Transmit Gain Setup</b></p> <p>Define the CODEC transmitting gain settings for the external speaker using an amplifier.</p>	1 ~ 63 (-15.5 ~ +15.5dB)	32		✓	
31-06-05	<p><b>External Speaker Control – CODEC Receive Gain Setup</b></p> <p>Select the CODEC gain types (1 ~ 32) for each External Page Speaker.</p>	<p>External Paging Speaker/Zone: 1 ~ 9</p> <p>1 ~ 63 (-15.5 ~ +15.5dB)</p>	32		✓	

Program Number	Program Name/Description	Input Data	Default	Level		
				1	2	3
31-07-01	<b>Combined Paging Assignments</b> Assign an External Paging Group (0 ~ 8) to an Internal Paging Zone (0 = All Call, Zones 1 ~ 64) for Combined Paging. When an extension user makes a Combined Page, they simultaneously broadcast into both the External and Internal Zone.	0 ~ 64 (0 = All internal paging)	1	✓		
31-08-01	<b>BGM on External Paging – BGM</b> Assign the Background Music option for each External Paging Speaker. If enabled, the system plays Background Music over the zone when it is idle.	External Paging Speaker/Zone: 1 ~ 9 0 = Disable 1 = Enable	0		✓	

## Operation

### To Page into an external zone:

1. Press External Paging key (Program 15-07 or SC 751: 19 for External Paging zones or 20 for External All Call Paging).
2. Make announcement.
  - OR -
  - 1. At the multiline terminal, press **Speaker** or pick up the handset.
    - OR -
    - At single line telephone, lift the handset.
  - 2. Dial **703** and the External Paging Zone code (1~8 or 0 for All Call).
    - OR -
    - Dial **\*1** and the Combined Paging Group code (1~8 or 0 for Internal/External All Call).
      - ◇ *Display indicates the Combined Paging as an External Page.*
      - ◇ *If the Internal Page Zone is busy or if there are no extensions in a page group, the page may be announced as an External Page only.*
3. Make an announcement.

4. Dial **703** and the External Paging Zone code (1~8 or 0 for All Call).

- OR -

Dial **\*1** and the Combined Paging Group code (1~8 or 0 for Internal/External All Call).

◇ *Display indicates the Combined Paging as an External Page.*

◇ *If the Internal Page Zone is busy or if there are no extensions in a page group, the page may be announced as an External Page only.*

5. Make an announcement.

## Paging, External (VRS)

### Description

Paging, External (VRS) enables the use of prerecorded VRS messages for External Paging. The advantage of this feature is saving time for the users who regularly use External Paging with the same announcements.

### Conditions

- If VRS External Paging is answered using the meet me paging service code and both parties are connected, VRS stops the announcement.
- Paging, External (VRS) does not support Internal Paging. Also, combined paging is not supported.
- The paging telephone must remain off-hook during paging. If the paging telephone hangs up during paging, VRS External paging stops.
- If an invalid VRS number is dialed or, there is no recorded VRS greeting, the caller hears an error tone.
- Paging, External (VRS) will not play the starting and ending tone if enabled. If the starting and ending tones are needed, they must be recorded in the VRS message itself.
- After the recorded VRS message is finished, the paging telephone hears a busy tone.
- When using the speaker mode on a paging telephone, the telephone becomes idle after the recorded VRS message finishes.
- Embedded VRS is not supported with SV9100.

### Default Settings

Disabled

### System Availability

#### Terminals

- All Multiline Terminals
- Single Line Telephones
- Cordless Terminals
- ISDN Terminals
- H.323 Terminals

- Standard SIP Terminals

Required Component(s)

- CPU license for VRS
- GCD-8DLCA, GCD-16DLCA or GCD-LTA for PGD(2)-U10 ADP
- PGD(2)-U10 ADP for Zone Paging
- 1- or 2-way amplifier and speakers (locally provided)

Related Features

- ➔ **Paging, External**
- ➔ **Voice Response System (VRS)**

Guide to Feature Programming

The **Level 1**, **Level 2** and **Level 3** columns indicate the programs that are assigned when programming this feature in the order they are most commonly used. These levels are used with PCPro and WebPro wizards for feature programming.

- Level 1 – these are the most commonly assigned programs for this feature.
- Level 2 – these are the next most commonly assigned programs for this feature.
- Level 3 – these programs are not often assigned and require an expert level working knowledge of the system to be properly assigned.

Program Number	Program Name/Description	Input Data	Default	Level		
				1	2	3
11-10-20	<b>Service Code Setup (for System Administrator) – VRS - Record/Erase Message</b> Define the service code to record or erase a VRS message.	MLT, SLT 0 ~ 9, *, # Maximum of eight digits	616		✓	
11-12-20	<b>Service Code Setup (for Service Access) – External Paging</b> External paging access code. Service code setup. ○ In case of normal Paging via External speaker: <Service code+Paging group number (0: all, 1-8)>. ○ In case of VRS Paging via External speaker: <Service code+* +Paging group number (0: all, 1-8)+VRS message number (001-100).	MLT, SLT 0 ~ 9, *, # Maximum of eight digits	703		✓	

Program Number	Program Name/Description	Input Data	Default	Level		
				1	2	3
20-07-13	<b>Class of Service Options (Administrator Level) – VRS Record (VRS Msg Operation)</b> Turn Off or On an extension user ability to record, erase and listen to VRS messages.	0 = Off 1 = On COS 1 ~ 14 = 0 COS 1 ~ 15 = 1	COS 1 ~ 14 = 0 COS 1 ~ 15 = 1		✓	

## Operation

### External VRS Messaging:

#### To page into an external zone with VRS message:

1. Pick up the handset or press Speaker at multiline terminal.
2. Dial **703** and **\*** then the External Paging Zone code (1-8, 0 for all call).
3. Dial VRS message Number (001-100).
4. Make announcement.
5. Press **Speaker** at multiline terminal or on-hook.

- OR -

1. Press DSS/One Touch Key programmed for External Paging.

#### To Program One Touch Key:

The following example shows how to program a On Touch key for External Paging zone 2 to play VRS greeting number 099.

1. Press **Speaker**.
2. Dial **7, 5, 1**.
3. Press **Line Key** to be programmed.
4. Dial **0, 1** (Function Code for DSS/One Touch Key).
5. Dial **7, 0, 3, \*, 2, 0, 9, 9**.
6. Press **Speaker**.

◇ *When using the Paging, External (VRS) feature, FC 20 (External All Call Paging code) cannot be used as a programmable function key.*

## Paging, Internal

### Description

Internal Paging lets extension users broadcast announcements to other multiline terminal users. When a user makes a Zone Paging announcement, the announcement broadcasts to all idle extensions in the zone dialed. With All Call Paging, the announcement broadcasts to all idle extensions programmed to receive All Call Paging. An extension can be a member of only one Internal Paging Zone. Like External Paging, Internal Paging allows a user to locate another employee or make an announcement without calling each extension individually.

### Combined Paging

Use Combined Paging when you want to simultaneously Page into an internal and corresponding external zone. For example, you can Page your company warehouse and outside loading dock at the same time. Combined Paging is available for Paging zones 1~8 and All Call. Optionally, you can change the Combined Paging assignments. For example, you can associate External Paging Zone 1 with Internal Paging Zone 4. You can program a Function Key as a Combined Paging key. When an All Call External Page Function Key is programmed, it includes both the external zones and the assigned internal zone(s). If the internal page zone is busy or there are no extensions in a page group, the announcement is made on the external zones only.

### Conditions

- Internal Paging does not require a PGD(2)-U10 ADP.
- A maximum of 50 extensions is supported for Internal or All Call Paging Group.
- A maximum of 50 TDM extensions are supported for Internal or All Call Paging Group.
- A maximum of 50 IP extensions are supported for Internal or All Call Paging Group.
- A system must have at least one extension port idle to make an Internal Page. If no extension port is idle, the extension performing the Page hears a busy signal.
- There are 64 available Internal Paging Groups (Zones).
- A Class of Service option is available in system programming to prevent display telephones from showing incoming internal paging information. This allows the system to save processor time and speed up system operation.
- An extension user can broadcast an announcement over an External Paging Zone.
- Function keys simplify Internal Paging operation.
- You must assign an extension to a two-digit zone in Program 31-02-01 before you can assign a function key using the 751 service code as a two-digit Internal Group Paging Zone key.
- If Auto Hold in Program 15-02-07 is set to Cut (1), when a user presses the page key while on a trunk call, the trunk call is put on hold.

- A single line telephone can initiate an Internal Zone page, but cannot receive an Internal Zone Page.
- If an internal paging group has only IP Multiline Stations, mutlicast is used for the page. IP multiline terminals must have a gateway programmed to accomplish a multicast transmission. When an actual gateway device does not exist on the network, a dummy gateway address on the same subnet must be defined.
- When a paging group contains all IP phones, the page is sent via a multicast message from the initiating IP phone. If a paging group has IP and TDM phones, when and IP phone initiates the page, a message is sent to the CPU and the CPU sends the multicast message for the IP phones.
- To receive the All Call Page, the extension must be assigned to an Internal Page Group.

### Default Settings

Enabled

## System Availability

### Terminals

All Multiline Terminals and Single Line Telephones

### Required Component(s)

None

## Related Features

- ↳ [Meet Me Paging](#)
- ↳ [Meet Me Paging Transfer](#)
- ↳ [Paging, External](#)
- ↳ [Programmable Function Keys](#)



## Guide to Feature Programming

The **Level 1**, **Level 2** and **Level 3** columns indicate the programs that are assigned when programming this feature in the order they are most commonly used. These levels are used with PCPro and WebPro wizards for feature programming.

- Level 1 – these are the most commonly assigned programs for this feature.
- Level 2 – these are the next most commonly assigned programs for this feature.
- Level 3 – these programs are not often assigned and require an expert level working knowledge of the system to be properly assigned.

Program Number	Program Name/Description	Input Data	Default	Level		
				1	2	3
11-12-19	<b>Service Code Setup (for Service Access) – Internal Group Paging</b> Service code setup.	MLT, SLT 0 ~ 9, *, # Maximum of eight digits	701		✓	
11-12-24	<b>Service Code Setup (for Service Access) – Combined Paging</b> Combined paging, internal/external access code. Service code setup.	MLT, SLT 0 ~ 9, *, # Maximum of eight digits	*1		✓	
15-07-01	<b>Programmable Function Keys</b> Assign function keys for Internal Paging Zones (code 21 + page zone) and Internal All Call Paging (code 22).	Line Key 1 ~ 48 0 ~ 99 (Normal Function Code 751 by default) *00 ~ *99 (Appearance Function Code) (Service Code 752 by default)	Refer to the Programming Manual for default values.	✓		
20-06-01	<b>Class of Service for Extensions</b> Assign a Class of Service (1 ~ 15) to an extension.	Day Night/Mode: 1 ~ 8 Class of Service of Extensions (1 ~ 15)	Extension port 101 = Class 15 All other extension port = Class 1	✓		
20-13-29	<b>Class of Service Options (Supplementary Service) – Paging Display</b> Turn Off or On an extension user ability to display paging information.	0 = Off 1 = On	COS 1 ~ 15 = 1		✓	
31-01-01	<b>System Options for Internal/External Paging – All Call Paging Zone Name</b> Assign a name to the All Call Internal Paging Zone. The name shows on the display of the telephone making the announcement.	Maximum of 12 characters.	Group All		✓	
31-01-02	<b>System Options for Internal/External Paging – Page Announcement Duration</b> Set the maximum allowable duration for a Paging announcement (External Paging only).	0 ~ 64800 seconds	1200		✓	
31-02-01	<b>Internal Paging Group Assignment – Internal Paging Group Number</b> Assign extensions to Internal Paging Zones. An extension must be assigned to a 2-digit zone to access any 2-digit zone.	Internal Page Zones: 0, 1 ~ 9, 00, 01 ~ 64 0 ~ 64 (0 = No Setting)	0 for IP Station 1 for TDM Station	✓		

Program Number	Program Name/Description	Input Data	Default	Level		
				1	2	3
31-02-02	<b>Internal Paging Group Assignment – Internal All Call Paging Receiving</b> Turn Off or On All Call Internal Paging for each extension. If allowed, extensions can make and receive All Call Internal Paging announcements. If prevented, extension can make only All Call Internal Paging announcements.	0 = Off 1 = On	0	✓		
31-03-01	<b>Internal Paging Group Settings – Internal Paging Group Name</b> Program names for the Internal Paging Zones.	Maximum of 12 characters.	01 = Group 1 02 = Group 2 : 64 = Group 64		✓	
31-07-01	<b>Combined Paging Assignments</b> For each External Paging Group (1 ~ 8 and 0 for All Call), assign a corresponding Internal Zone for Combined Paging	Internal Page Zones: 0, 1 ~ 9, 00, 01 ~ 64 0 ~ 64 (0 = All internal paging)	1		✓	

## Operation

### To make an Internal Page announcement:

#### Multiline Terminal

- Press the zone **Internal Paging** key (Program 15-07 or SC 751: 21 + 0 or 1~9 or 01~64 for zones (0 or 00 for All Call)).  
**- OR -**  
Press **Speaker** or lift the handset.
- Dial **701** and the Paging Zone number (0~9 or 00~64).  
◇ *Dialing 0 or 00 calls All Call Internal Paging.*  
**- OR -**  
Dial **\*1** and the Combined Paging Group code 1~8 or 0 (for Internal/External All Call).  
◇ *Display indicates the Combined Paging as an External Page.*  
◇ *If the Internal Page Zone is busy or if there are no extensions in a page group, the page is announced as an External Page only.*
- Make an announcement.
- Press **Speaker** to hang up.

**Single Line Telephone**

1. Lift the handset.
2. Dial **701** and the Paging Zone number (0~9 or 00~64).
  - ◇ *Dialing 0 or 00 calls All Call Internal Paging.*
  - ◇ *Dial \*1 and the Combined Paging Group code 1~8 or 0 (for Internal/External All Call).*
3. Make an announcement.
4. Hang up.

## Description

Park places a call in a wait state (called a Park Orbit) so an extension user may pick it up. Park has two types: System and Personal. System Park allows a user to have a call wait in System Orbit. Personal Park allows a user to Park a call at their extension so a co-worker can pick it up. After parking a call in orbit, a user can Page the person receiving the call and hang up. The paged party can dial a code or press a programmed Park key to pick up the call. With Park, it is not necessary to locate a person to handle their calls. A call parked for too long recalls the extension that initially parked it, however the call remains in the park orbit until it is answered. There are 64 Park Orbits (1~64) available for use.

### Extended Park

An extension Class of Service determines whether it uses the normal Park Orbit Recall time or the Extended Park Orbit Recall time. The timers are set in system programming. When an extension with Extended Park Recall Class of Service option parks a call, it recalls after the Extended Park Orbit Recall time. When an extension with the Normal Park Orbit Recall Class of Service option parks a call, it recalls after the normal Park Orbit Recall time, however the call remains in the park orbit until it is answered.

### Programmable Function Key and Service Code Available for Personal Park

The Personal Park feature is enhanced by using a Programmable Function Key or service code (3-digit or 1-digit) to place a call in Personal Park. This option is available for multiline terminals, single line sets, and UNIVERGE SV9100 Wireless telephones and can be used for analog or ISDN trunks.

## Conditions

- An extension user can park a call in any Park Orbit. However, an extension user can pick up only a call Parked by a member of their own Park group (see Program 24-03).
- When a 2-button telephone user parks a call, they must wait the Interdigit Time (normally 10 seconds) before trying to retrieve it.
- An extension can have only one Personal Park key.
- When the terminal that has a call in Personal Park is unplugged, the Personal Park is released and the held caller is placed on Non-Exclusive Hold.

- The following table indicates what condition the service codes and Programmable Function key can be used.

Status	Using 3-Digit Service Code	Using 1-Digit Service Code	Using Personal Park Key
Speaking	Not Available	Not Available	Available
ICM Dial Tone or Busy Tone	Available	Not Available	Available
Calling Another Extension	Not Available	Available (with outside call on hold and when called extension does not answer)	Available
Receiving a Personal Park Recall	Not Available	Not Available	Available

- A user can display the Caller ID of a call in Park if Caller ID is enabled (1) in Program 20-09-02.
- Park keys can be assigned on DSS consoles.
- Calls on virtual extension keys cannot be put in Personal Park if Program 15-18-01 is set to Land on the key (1).
- Function keys simplify Park operation.
- One Touch keys programmed for Park Hold Service Code cannot be used to park calls without using Hold or Transfer.
- Call Park – Step Call is supported in the local system only.
- A parked call cannot be retrieved from Hold Dial Tone (Second dial tone).
- When a call is parked from a virtual extension, the virtual extension is released.
- When parking a call from a virtual extension, Programs 15-02-21 and 15-18-01 must be set to 1.
- Park Group assignment is by the terminal extension, not the virtual extension.
- When a call parked from a virtual extension recalls, it will ring the terminal the virtual extension is programmed on, not the virtual extension key.
- Park Retrieve is not supported using DISA.
- With Version 4000 or higher software, Mobile Extension can answer a park call by automatically dialing or by manually dialing the answer park hold service code through a DID Trunk.

## *Personal Park at a Co-Worker's Extension*

### Description

The Personal Park feature allows an extension user to place an outside call, which is on hold, on Personal Park at a co-worker's extension after placing an intercom call. This feature is available for keysets, SLTs, IP terminals and IP DECT terminals.

### Conditions

- If an internal call forwards before Personal Park on a Co-Worker's Extension is performed, the call is Parked in the originator's Personal Park orbit.
- This feature is not available when calling a Department Group's pilot number.
- If an extension user has a call in Personal Park and the terminal is unplugged, the Personal Park is cancelled and the held caller hears a busy tone.
- This feature does not work when calling a Networked or virtual extension.
- If an extension already has a call in their Personal Park Orbit, the Personal Park for a Co-Worker's Extension will not work until the first call is retrieved from Park.
- A Personal Park Programmable Function Key or the Soft Key must be used to park the call in a co-worker's park. This operation cannot be done using a service code.
- An extension can park a call in any Park Orbit. However, an extension can only pick up a call Parked by a member of its own Park group (see Program 24-03).
- If an extension is not allowed access to trunks in the Access Maps (Program 14-07 and Program 15-06), calls in Park and on Hold can be blocked.

### Default Setting

Enabled

### System Availability

#### Terminals

All Terminals

#### Required Component(s)

None

## Related Features

- ➔ [Caller ID](#)
- ➔ [Call Arrival \(CAR\) Keys](#)
- ➔ [Direct Station Selection \(DSS\) Console](#)
- ➔ [Hold](#)
- ➔ [Programmable Function Keys](#)

## Guide to Feature Programming

The **Level 1**, **Level 2** and **Level 3** columns indicate the programs that are assigned when programming this feature in the order they are most commonly used. These levels are used with PCPro and WebPro wizards for feature programming.

- Level 1 – these are the most commonly assigned programs for this feature.
- Level 2 – these are the next most commonly assigned programs for this feature.
- Level 3 – these programs are not often assigned and require an expert level working knowledge of the system to be properly assigned.

Program Number	Program Name/Description	Input Data	Default	Level		
				1	2	3
11-12-31	<b>Service Code Setup (for Service Access) – Park Hold</b> Set the service code used for placing a call in Park.	MLT, SLT 0 ~ 9, *, # Maximum of eight digits	#6		✓	
11-12-32	<b>Service Code Setup (for Service Access) – Answer for Park Hold</b> Set the service code used for answering a call in Park.	MLT, SLT 0 ~ 9, *, # Maximum of eight digits	*6		✓	
11-12-35	<b>Service Code Setup (for Service Access) – Station Park Hold</b> Set the service code used for placing a call in a Personal Park.	MLT, SLT 0 ~ 9, *, # Maximum of eight digits	757		✓	
11-16-11	<b>Single Digit Service Code Setup – Station Park Hold</b> Customize the one-digit service code used when placing a call in Personal Park.	Customize the one-digit service code used when placing a call in Personal Park.	No Setting		✓	
15-02-08	<b>Multiline Telephone Basic Data Setup – Automatic Handsfree</b> Set whether pressing a One-Touch key preselects the key or goes off-hook to access the key.	0 = Preselect 1 = One-Touch (Automatic Handsfree)	1	✓		

Program Number	Program Name/Description	Input Data	Default	Level		
				1	2	3
15-07-01	<b>Programmable Function Keys</b> Assign a keys as a Park Orbit key (code *04 plus Park orbit number [01 ~ 64]) or as a Personal Park key.	Line Key 1 ~ 48 0 ~ 99 (Normal Function Code 751 by default) *00 ~ *99 (Appearance Function Code) (Service Code 752 by default)	Refer to the Programming Manual for default values.	✓		
15-18-01	<b>Virtual Extension Key Enhanced Options – Virtual Extension Key Operation Mode</b> Set whether an incoming call to a Virtual Extension/CAR resides on the Virtual Extension/CAR key once answered (1) or appears on a CAP Key/CO Appearance Line key (0). This setting applies to multiline terminals, single line telephones and virtual extension numbers.	0 = Release 1 = Land On the Key	0		✓	
15-18-02	<b>Virtual Extension Key Enhanced Options – Display Mode when pacing a call on Virtual Extension Key</b> Define whether calls to or from a Virtual Extension Key display the Virtual Extension Key name or the name of the extension on which it resides.	0 = Secondary Extension Name 1 = Actual Station Name	0		✓	
20-06-01	<b>Class of Service for Extensions</b> Assign a Class of Service (1 ~ 15) to extensions.	Day Night/Mode: 1 ~ 8 Class of Service of Extensions (1 ~ 15)	Extension port 101 = Class 15 All other extension port = Class 1	✓		
20-11-19	<b>Class of Service Options (Hold/Transfer Service) – Hold/Extended Park</b> Determine whether an extension Class of Service should allow normal or extended Park.	0 = Normal 1 = Extended	COS 1 ~ 15 = 0		✓	
20-11-24	<b>Class of Service Options (Hold/Transfer Service) – Trunk Park Hold Mode</b> Set the hold type when a trunk call is put on hold by an extension.	0 = Non Exclusive Hold (Off) 1 = Exclusive Hold (On)	COS 1 ~ 15 = 1		✓	
20-11-25	<b>Class of Service Options (Hold/Transfer Service) – Transfer Park Call</b> Turn Off or On an extension user ability to transfer a parked call.	0 = Off 1 = On	COS 1 ~ 15 = 1		✓	
20-11-26	<b>Class of Service Options (Hold/Transfer Service) – Station Park Hold Mode</b> Turn Off or On an extension users ability to Personal Park on a Co-Worker's extension.	0 = Off 1 = On	COS 1 ~ 15 = 0		✓	
20-11-27	<b>Class of Service Options (Hold/Transfer Service) – Call Park Automatically Search</b> Turn Off or On using the Call Park Automatically Search option.	0 = Off 1 = On	COS 1 ~ 15 = 1		✓	



Program Number	Program Name/Description	Input Data	Default	Level		
				1	2	3
24-01-02	<b>System Options for Hold – Hold Recall Callback Time</b> A trunk recalling from Hold or Park rings an extension for this time. After this time the system invokes the Hold recall time again. Cycling between Hold recall time and callback time and normal or extended (Recall) Park Hold time continues until a user answers the call.	0 ~ 64800 seconds	30		✓	
24-01-06	<b>System Options for Hold – Park Hold Time - Normal</b> Set the Park Hold Time. A call left parked longer than this time recalls the extension that initially parked it.	0 ~ 64800 seconds	90		✓	
24-01-07	<b>System Options for Hold – Park Hold Time - Extended (Recall)</b> Set the Extended Park Hold Time. A call left parked longer than this time recalls the extension that initially parked it.	0 ~ 64800 seconds	300		✓	
24-03-01	<b>Park Group – Park Group Number</b> Assign an extension to a Park Group. An extension user can pick up only a call parked by a member of their own Park Group.	1 ~ 64	1		✓	

## Operation

### To Park a call in a system orbit:



*You can Park Intercom or trunk calls.*

TIP

1. Press the **Park** key (Program 15-07 or SC 752: \*04 + orbit).
    - ◇ *The Park key LED lights.*
    - ◇ *If you hear busy tone, the orbit is busy. Try another orbit.*
  2. Use Paging to announce call.
  3. Press **Speaker** to hang up.
    - ◇ *If not picked up, the call recalls to you.*
- OR -
1. At the multiline terminal or 2-button telephone, press **Hold**.
    - OR -
 At a 500/2500 single line telephone, hookflash.

2. Dial **#6** and the Park orbit (01~64).
  - ◇ *If you hear busy tone, the orbit is busy. Try another orbit.*
  - ◇ *If you hear a busy tone, the orbit is busy. Dial #6\* if enabled in Program 20-11-27 (Call Park AutoSearching) to search for an idle park location in ascending order.*
3. Use Paging to announce the call.
4. Press **Speaker** to hang up.
  - ◇ *If not picked up, the call recalls to you.*
  - ◇ *The parked call recalls after the Park Hold Time (Program 24-01-06). The call rings the extension to which it recalled for the Hold Recall Callback Time (Program 24-01-02). The call then goes on Hold for the Park Hold Time, then recalls again for the Hold Recall Callback Time. The call continues to cycle between Hold and recall until the extension user answers the call or the outside party hangs up.*

### To pick up a parked call:

1. Lift the handset.
2. Press the **Park** key (Program 15-07 or SC 752: \*04 + orbit).
  - OR -
  - 1. At the multiline terminal or 2-button telephone, press **Speaker**.
    - OR -
    - At single line telephone, lift the handset.
2. Dial \*6 and the Park orbit (01~64).

### To park a call at your extension:

1. Press **Hold** and dial 757.
  - OR -
  - Press **Hold** and the **Personal Park** key (Program 15-07 or SC 752: \*07).
    - ◇ *At a 500/2500 single line telephone, hookflash instead of pressing **Hold**.*
    - ◇ *A confirmation tone is heard and the call is parked at your extension. If the extension has a Personal Park key, the key flashes.*
    - ◇ *The Personal Park single-digit service code (Program 11-16-11) cannot be used in this operation.*
2. Page your co-worker to pick up the call.
3. Press **Speaker** to hang up (or hang up at the single line telephone).
  - ◇ *If not picked up, the call recalls to you.*

### To park a personal call at your extension after trying to call a co-worker:

1. While on a call, press **Transfer/Hold**.
  - ◇ *Program 20-11-26=0 for an extension's Class of Service required.*

2. Dial a co-worker's extension number.
  - ◇ *The co-worker does not answer.*
3. Press the **Personal Park** key (Program 15-07 or SC 752: \*07).
  - OR -
  - Dial the Personal Park single digit code (Program 11-16-11).
    - ◇ *The Intercom call to the co-worker is dropped. A confirmation tone is heard and the outside call is parked at your extension.*
    - ◇ *If the co-worker answers the call, the outside call rings back after the intercom call is completed. The call can then be placed in Personal park if desired.*

**To Park a personal call at a co-worker's extension after calling them:**



*An extension's Class of Service must allow the user to park the call at a co-worker's extension (Program 20-11-26 = 1).*

- NOTE
1. While on a call, press **Transfer/HOLD**.
  2. Dial a co-worker's extension number.
    - ◇ *The co-worker does not answer.*
  3. Press the Personal Park key (Program 15-07 or SC 752: \*07).
    - OR -
    - Press the StaP Soft Key.
    - OR -
    - Dial the Personal Park single digit code (Program 11-16-11).
      - ◇ *The Intercom call to the co-worker is dropped. A confirmation tone is heard and the call is parked at the co-worker's extension.*
      - ◇ *If the co-worker does not answer the call, it will recall to the originator's extension.*

**To pick up a call parked at your extension:**

1. Press the **Personal Park** key (Program 15-07 or SC 752: \*07).
  - OR -
  - Press **Speaker** and dial **757**.
    - ◇ *At a single line telephone, do not press **Speaker**.*
    - ◇ *The Personal Park single-digit service code (Program 11-16-11) cannot be used in this operation.*

**To answer a call parked at a co-worker's extension:**

1. Press **Speaker**, dial \*\* plus the co-worker's extension number.
  - ◇ *At a single line telephone, do not press **Speaker**.*

## To display Caller ID for a call in Park:

When Program 15-02-08 is set to 0 (preselect) for this feature.

1. With Program 15-02-08 set to 0 (preselect) and a call in Park, press the **Park** key. (Program 15-07 or SC 752: \*04).

- OR -

With Program 15-02-08 set to 1 (One-Touch), and a call in Park, press **Feature**, then the **Park** key (Program 15-07 or SC 752: \*04).

## Call Park – Step Call:

To Park a call in the first available system orbit:



TIP

*You can Park Intercom or trunk calls.*

1. Press **Hold** or **Transfer**.
  2. Dial **#6**.
    - ◇ *If you hear a busy tone, the orbit is busy. Proceed to step 3.*
  3. Dial **\***.
    - ◇ *Program 20-11-27 must be enabled in the multiline terminals Class of Service.*
  4. Press **Speaker** to hang up.
    - ◇ *If not picked up, the call will recall to you.*
- OR -
1. Press **Hold** or **Transfer**.
  2. Press the DSS/BLF key programmed as **#6\***  
(The Park location will be displayed in the LCD).
  3. Press **Speaker** to hang up.

## PBX Compatibility

### Description

You can connect your telephone system trunks to Centrex/PBX lines, rather than to Telco trunk circuits. This makes the trunk inputs to the system 500/2500 type compatible Centrex/PBX extensions, rather than Telco circuits. PBX Compatibility lets the system be a node (i.e., satellite) in a larger private telephone network. To place outside calls when the system is behind a PBX, telephone system users must first dial the PBX trunk access code (usually 9).

The system provides the following PBX Compatibility options:

- PBX Trunk Access Code Screening  
The system can monitor the numbers users dial and screen for PBX trunk access codes. The system can screen up to four groups of trunk access codes. The codes can have one or two digits, consisting of the digits 0~9, # and \*. (You use Line Key 1 as a wild card entry.)
- PBX Trunk Toll Restriction  
The system can provide the Toll Restriction for the PBX trunk, or restriction can be handled solely by the connected PBX. If the telephone system provides the restriction, it restricts the digits dialed after the PBX access code.
- PBX Call Restriction  
When the telephone system does the Toll Restriction, it can further restrict users from dialing PBX extensions. In this case, the only valid numbers are those dialed after the PBX trunk access code. The only PBX facility telephone system users can access are the PBX outside trunks.
- Automatic Pause  
The system automatically pauses when it sees a PBX trunk access code during manual dialing, Speed Dialing, Last Number Redial, Repeat Redial and Save Number Dialed. This gives the connected PBX time to set up its trunk circuits.

### Conditions

- When using Account Codes, do not use \* in a PBX access code. Otherwise, after the \*, the trunk stops sending digits to the central office.
- The system automatically pauses after it finds a PBX access code in a Speed Dialing bin.
- If Speed Dialing routes a call to a PBX trunk, it does not automatically insert a PBX access code. It outdials the digits just as they are stored.
- Users answer incoming calls on PBX trunks just like other trunks. All relevant access and Ring Group programming applies.
- Except for dialing the PBX access code, users place calls on PBX trunks just like other trunks. All relevant access programming applies. Refer to the [Central Office Calls, Placing on page 2-230](#) feature for more details.

- You can have DILs route from the connected PBX. Users can access these trunks for outgoing PBX calls. All PBX Compatibility restrictions and programming apply.
- Flash may allow access to certain PBX features – like Transfer. Make sure you program Flash for compatibility with the connected PBX.
- The system does not provide automatic Pulse to Tone Conversion after outdialing the PBX trunk access code.
- You can program incoming DISA trunks to be outgoing PBX trunks. All PBX Compatibility restrictions and programming apply.
- PBX trunks can follow normal system Toll Restriction.
- Users can get outbound access to PBX trunks through Trunk Groups and/or Trunk Group Routing. All PBX Compatibility restrictions and programming apply.
- If the system routes a call to a PBX trunk, it does not automatically insert the PBX access code. It outdials the call just as the user dialed it.

### Default Settings

Disabled

## System Availability

### Terminals

All Terminals

### Required Component(s)

None

## Related Features

- ➔ [Account Code Entry](#)
- ➔ [Call Forwarding – Centrex](#)
- ➔ [Central Office Calls, Answering](#)
- ➔ [Central Office Calls, Placing](#)
- ➔ [Code Restriction](#)
- ➔ [Direct Inward Line \(DIL\)](#)

- ➔ [Direct Inward System Access \(DISA\)](#)
- ➔ [Flash](#)
- ➔ [Pulse to Tone Conversion](#)
- ➔ [Ring Groups](#)
- ➔ [Speed Dial – System/Group/Station](#)
- ➔ [Trunk Groups](#)
- ➔ [Trunk Group Routing](#)

## Guide to Feature Programming

The **Level 1**, **Level 2** and **Level 3** columns indicate the programs that are assigned when programming this feature in the order they are most commonly used. These levels are used with PCPro and WebPro wizards for feature programming.

- Level 1 – these are the most commonly assigned programs for this feature.
- Level 2 – these are the next most commonly assigned programs for this feature.
- Level 3 – these programs are not often assigned and require an expert level working knowledge of the system to be properly assigned.

Program Number	Program Name/Description	Input Data	Default	Level		
				1	2	3
14-01-01	<b>Basic Trunk Data Setup – Trunk Name</b> Set the names for trunks. The trunk name displays on a multiline terminal for incoming and outgoing calls.	Maximum of 12 characters.	Line 001 Line 002 Line 003 : Line 400	✓		
14-01-02	<b>Basic Trunk Data Setup – Transmit Level</b> Set these options for compatibility with the connected PBX.	Trunks 1 ~ 400 1 ~ 57 (-15.5 ~ +12.5dB in 0.5dB intervals)	32 (0dB)	✓		
14-01-08	<b>Basic Trunk Data Setup – Toll Restriction</b> For each PBX trunk port, Enable/ Disable Toll Restriction.	0 = Restriction Disabled (No) 1 = Restriction Enabled (Yes)	1	✓		
14-02-01	<b>Analog Trunk Data Setup – Signaling Type (DP/DTMF)</b> At default, Program 14-02-01 is set to 2 (DTMF).	0 = Dial Pulse (10 PPS) 1 = Dial Pulse (20 PPS) 2 = DTMF	2	✓		
14-02-02	<b>Analog Trunk Data Setup – Ring Detect Type</b> Set Extended Ring Detect or Immediate Ring Detect for the trunk. For T1 loop/ground start trunks, this option must be set to 1 for the trunks to ring and light correctly.	Trunks 1 ~ 400 0 = Normal/delayed 1 = Immediate Ringing	1	✓		

Program Number	Program Name/Description	Input Data	Default	Level		
				1	2	3
14-04-01	<b>Behind PBX Setup</b> For each PBX trunk port, enter 1. Make a separate entry for each Night Service mode.	0 = Stand Alone (Trunk) 1 = Behind PBX (PBX) 2 = Not Used 3 = CTX assume 9	0	✓		
21-04-01	<b>Toll Restriction Class for Extensions</b> Assign a Toll Restriction Class (1 ~ 15) to each extension.	Day/Night Mode 1 ~ 9 (9 = Power Failure Mode) Restriction Class 1 ~ 15	2		✓	
21-05-12	<b>Toll Restriction Class – PBX Call Restriction</b> For each Toll Restriction Class, enter 1 to restrict calls on the PBX trunk to outside calls only. Enter 0 to allow users to dial PBX extensions.	0 = Disable (No) 1 = Enable (Yes)	1 ~ 6, 8 ~ 15 = 0 7 = 1		✓	
21-06-08	<b>Toll Restriction Table Data Setup – PBX Access Code</b> Enter the system PBX access codes. The system can have up to four codes. A code can have one or two digits. Valid entries are 0 ~ 9, # and *. Use Line Key 1 as a don't care digit. If using Account Codes, do not use the * in the PBX Access Code.	Dial (maximum of two digits)	Dial (Up to two digits) default: Table 1 ~ 4 = No Setting		✓	

## Operation

### To place a call over a PBX trunk:

1. At multiline terminal, press **Speaker** and dial **704**.  
- OR -  
At single line telephone, lift the handset and dial **704**.
2. Dial PBX trunk group number (**1~9** or **001~100**).
3. Dial PBX access code and number.  
- OR -
  1. At the multiline terminal only, press **PBX trunk group** key (Program 15-07 or SC 752: \*02 + group).
  2. Dial PBX access code and number.  
- OR -
    1. At the multiline terminal, press **Speaker** and dial **9**.  
- OR -  
At the single line telephone, lift the handset and dial **9**.



2. Dial the PBX access code and number.  
- OR -
1. At the multiline terminal, press **Speaker**.  
- OR -  
At the single line telephone, lift the handset.
2. Dial **#9**.
3. Dial the PBX trunk number (e.g., 005 for line 5).
4. Dial the PBX access code and number.  
- OR -
1. Press the **PBX trunk key** (Program 15-07 or SC 752: \*01 + 1 to 400).
2. Dial the PBX access code and number.  
◇ *In all cases above, Toll Restriction may prevent your call.*

## PC Programming

### Description

The UNIVERGE SV9100 has three different methods for programming. The first is via the handset, the second is by PCPro and third by WebPro.

PCPro is a Microsoft Windows based application. It allows the technician/system administrator to download a database from the system, make changes, and then upload.

The WebPro application is a web server running on the GCD-CP10 blade of the SV9100 system. No special installation program is required. With Version 4000 or lower, when programming the system, use Internet Explorer other web browsers are not currently supported.

With Version 5000 or higher, the following browsers are supported:

- Internet Explorer 6.0 or higher
- Chrome 48 or higher
- Edge 20 or higher

An overview of the three programming applications is shown below.

Figure 2-68 PC Programming Overview

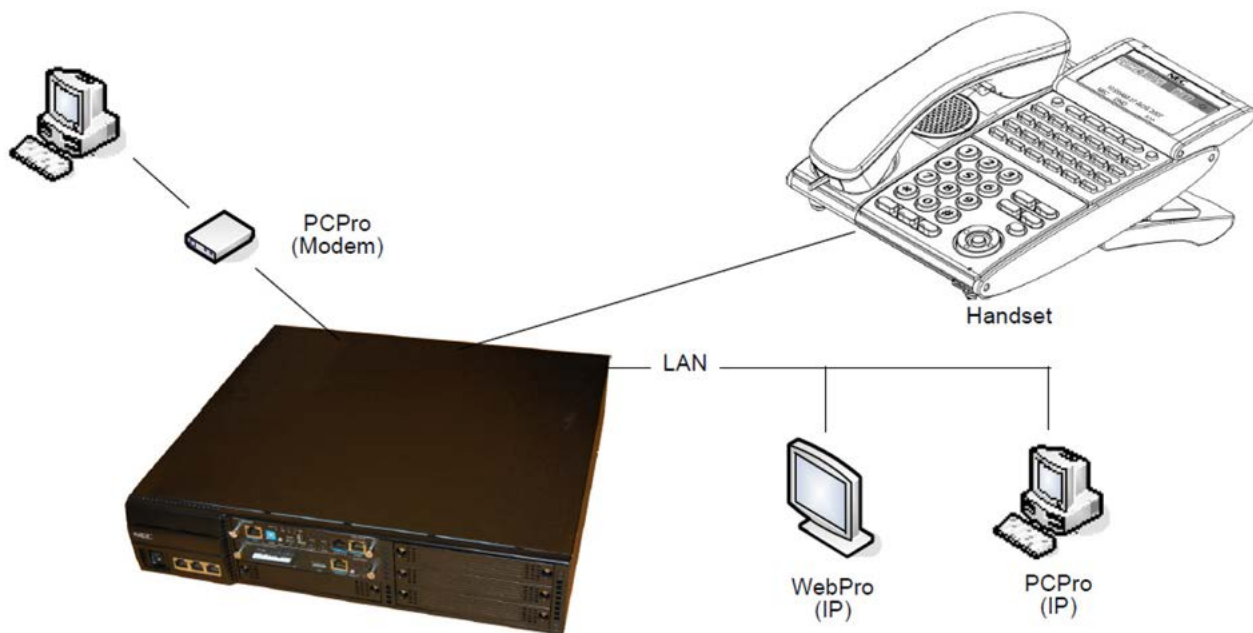

**Connecting**

As shown in [Figure 2-68 PC Programming Overview](#), three connection types are available to PCPro/WebPro.

If using PCPro, a user can connect directly, remotely using a modem or via LAN. A connection with the system is made via the Connection Dialog in the application. (Refer to [Figure 2-69 PCPro Connection Dialog on page 2-1287.](#))

- ❑ *Modem (remote) connections are established via the internal GCD-CP10 modem. To access the modem, dial a trunk that is directed to the modem access service code (DIL or DID) or dial an extension that is redirected to the modem access service code. When connecting with a Modem, a Dial Up Connection (PPP) must be set up in Windows Network Connections.*
  - ◇ *When uploading via a Dial Up connection, uploading card configuration (Hardware Upload) is not supported.*
  - ◇ *For modem (remote) connections Program 10-21-07 must be enabled.*
- ❑ *IP (LAN) connections are established via the Ethernet connector on the GCD-CP10 blade.*

Figure 2-69 PCPro Connection Dialog

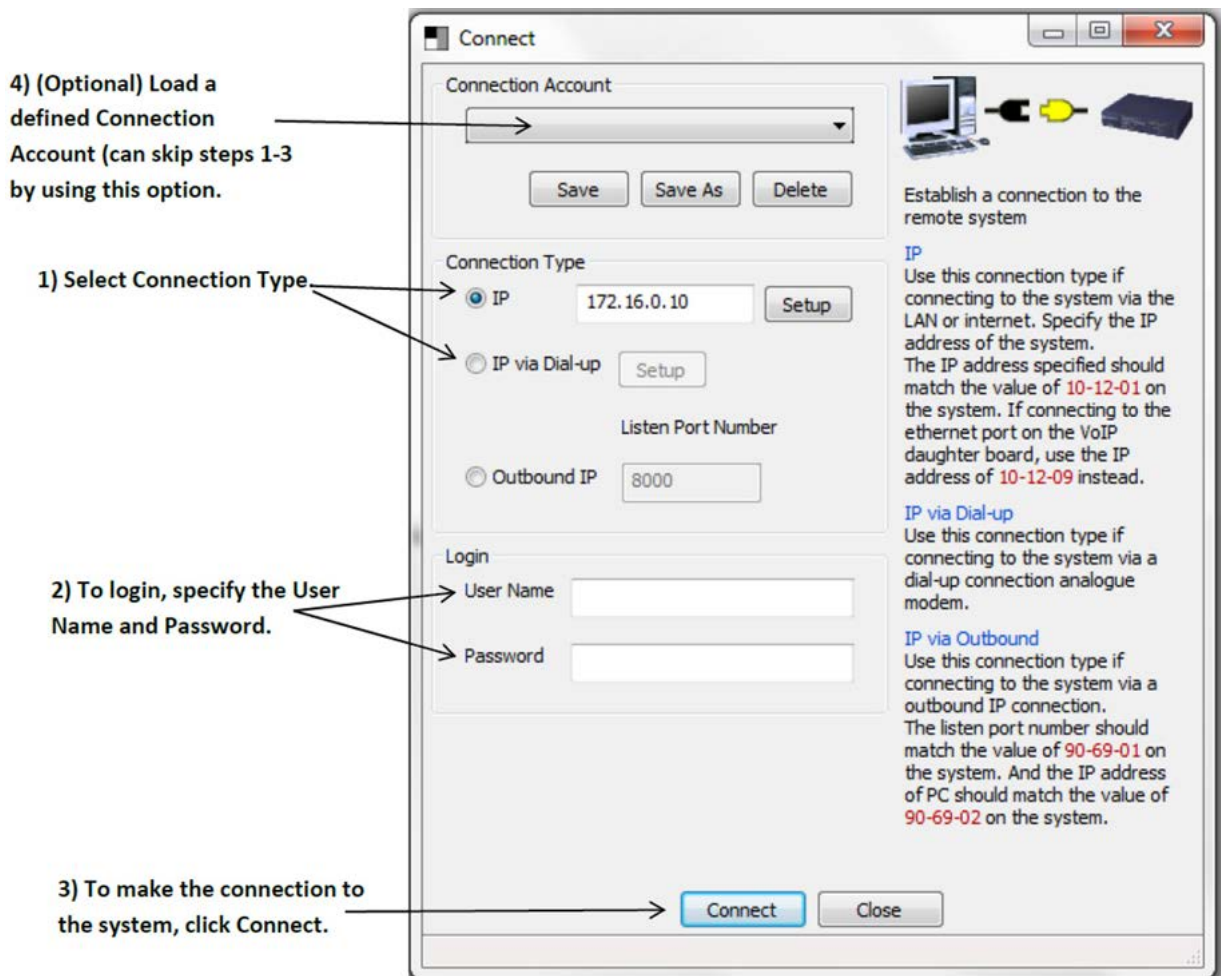

If using WebPro, a user can connect only via IP. To connect, launch any supported browser and enter the IP address of the switch (refer to [Figure 2-70 WebPro Login Screen](#)).

Figure 2-70 WebPro Login Screen



## WebPro System Programming

WebPro can be used to edit system programming from a Web browser. System Data, License Information, and Modification History are among the items that can be viewed in WebPro (refer to [Figure 2-71 WebPro Home Page](#)).

Figure 2-71 WebPro Home Page

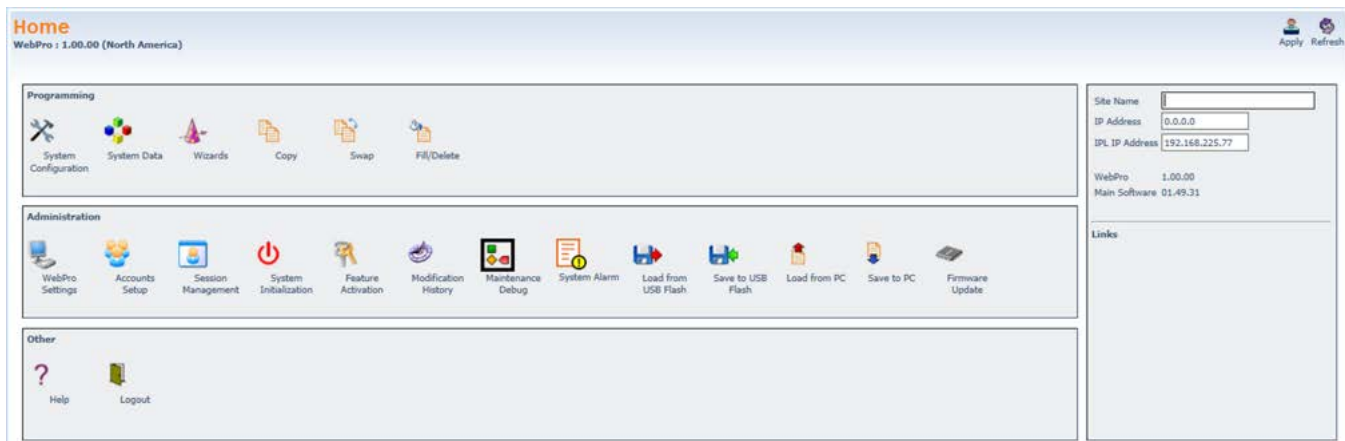

The Maintenance Debug section is added to allow the WebPro user to turn on debug traces for engineering troubleshooting (refer to [Figure 2-72 Maintenance Debug Screen](#)).

Figure 2-72 Maintenance Debug Screen

Service Name	Trace Command Operation	Trace Status	DIM Command Reference
CAPS	Disable	-----	mail in 0 0 0 0
Call Control	Disable	-----	mail in 0 0 1 2
ISDN	Disable	-----	path debug on /path debug off
PATH	Disable	-----	mail in 0 doff 1 1 / mail in 0 doff 0 1
InMail / APSU	Disable	-----	vmuid 1 15
InMail detail	Disable	-----	cygnet dp 1 / cygnet dp 0
Netlink	Disable	-----	voipccdebug 0 1 / voipccdebug 0 0
SIP Trunk	Disable	-----	voipccdebug 5 1 / voipccdebug 5 0
STD SIP	Disable	-----	voipccdebug 5 2 / voipccdebug 5 0
STD SIP Register	Disable	-----	sipmit dbg c 1 / sipmit dbg c 0
SIPMLT Path	Disable	-----	sipmit dbg f 1 / sipmit dbg f 0
SIPMLT Error	Disable	-----	mail i 0 9ff 0 0
IOCS	Disable	-----	

### WebPro End User Programming

WebPro has an End User Login for which extensions can program functions for their own extension. They can program Function keys, Virtual Extension ringing assignment, Station Speed Dial, InMail features, Station Name, Call Forwarding, Display Language, Ring Tone and End User Password.

To login to the WebPro End User Programming, point to the IP address of the system in a web browser like you would logging into WebPro. Use the extension number as the User Name (refer to [Figure 2-73 WebPro End User Screen](#)) and the password is assigned in Program 90-28-01 (Default is 1111).

Figure 2-73 WebPro End User Screen

**Telephone Setting**

Apply Refresh Logout

- Feature Setup
- Function Key Assignment
- Virtual Extension Ring Assignment
- One Touch Key Assignment
- InMail Station Mailbox Options
- Station Mailbox Message Notification Options
- Station Mailbox Find-Me Follow-Me Options
- InMail Audio Up/Down load
- Setting of function key for bth handset
- Multi-Device Group Setup

[Extension 101]

Name: STA 101

Name(Chinese Character):

Call Forward Type: No Call Forward

CO Call Forward Destination for Both Ring, All Calls and No Answer:

Intercom Call Forward Destination for Both Ring, All Calls and No Answer:

CO Call Forward Busy Destination:

Intercom Call Forward Busy Destination:

Display Language Selection: English

Incoming Ring Tone: Trunk Incoming Ring Tone: Medium, Internal Incoming Ring Tone: Melody 5

Toll Restriction Override Password:

Night Mode Switching: Mode 1

End User Password: 1111

Ten key Backlit Control: Normal

Valid characters are 0-9, #, \*, P, R, @, P=Pause, R=Hookflash, @=Wildcard

## Conditions

- With SV9100 software and GPZ-IPLE daughter board installed, half duplex connections are not supported. For troubleshooting purposes, a managed switch capable of port mirroring is required to capture packet data from the SV9100 IPLE Ethernet port.
- When connecting via a dial up connection, a Dial Up Connection (PPP) must be configured in Windows Network Connections.
- When uploading via a Dial Up connection, uploading card configuration (Hardware Upload) is not supported.
- The hardware/software requirements for the host PC running the PCPro application are:

Item	Requirement
CPU	Pentium® III 598MHz (minimum) Pentium 4 2.5GHz (recommended)
Memory	128MB of RAM, 256MB (recommended)
Operating System (OS)	Windows XP or Microsoft Vista Windows 7 (32- and 64-bit)
Other	Microsoft Internet Explorer 6.0 or higher
Communication Port	LAN, or Modem
Disk Space	35MB for PCPro (minimum)
TCP Port	TCP port 8000 must be open between the terminal and the host PC for uploading/downloading via LAN. PCPro/WebPro TCP port is set for 8000 at default, but can be changed via WebPro using Program 90-54-02.
Screen Resolution	800 x 600 (minimum) 1024 x 760 (recommended)

- The hardware/software requirements for the host PC running WebPro are:

Item	Requirement
Browser	<ul style="list-style-type: none"> <li> With Version 4000 or lower: Internet Explorer 6.0 or higher</li> <li> With Version 5000 or higher: Internet Explorer 6.0 or higher Chrome 48 or higher Edge 20 or higher</li> </ul>
Network	IP connection to the KTS
Screen Resolution	800 x 600 (minimum) 1024 x 760 (recommended)

- You can have a maximum of four users logged into WebPro anytime.

- You can have up to two phones in programming mode anytime.
- You can have two WebPro users and two phone programming users logged in at the same time for a **total of four users** in programming mode simultaneously. However, the two phone programming users do not show up in session management in WebPro.
- PCPro can be logged in with only one user. This is allowed only if no other users are logged into programming mode (PCPro, WebPro, or Phone). Also, if a user is connected to the switch via PCPro, no other user can log in through PCPro, WebPro, or Phone Programming.
- Only one PCPro/WebPro/Handset can be programming the switch anytime.
- When programming via WebPro/PCPro, some data requires you to logout before the switch fully applies the changes. These Programs are: 10-21-2, 11-02 (for directory dial), 11-04 (for directory dial), 13-04 (for directory dial), 14-04, 15-05, 15-15, 16-02, 23-02, 31-02, 41-02, 41-17, 47-02, 47-03, 82-11 and 83-11.
- In the card configuration window, if you click a card type in the main menu, the menu closes. You must mouse over the card type to open the submenu to list all cards of that type.
- To access the modem over K-CCIS, route the modem access service code to the target switch. Do not call a station that is call forwarded to the service code. When accessing the modem over K-CCIS, enter the service code to be dialed in PC Pro.
- ◇ *PC Pro follows the PC dialing properties. If dialing a service code, you must turn off the dial 9 for outside line and area code inclusion or PC Pro will dial these digits as well.*
- Some program items require second initialization of the KTS before they take effect. These Programs are: 10-12-01, 10-12-02, 10-12-03, 10-12-04, 10-13-01, 10-13-02, 10-13-03, 10-14, 10-15, 10-16-01, 10-16-02, 10-16-03, 10-16-04, 20-01-03, 47-01-01, 80-01, 80-02-01, 80-02-02, 80-02-03, 80-02-04, 80-03, 80-04, 84-03-01, 84-03-02, 84-03-06, 84-03-07, 84-03-08, 84-05-01, 84-05-02, 84-06-01, 84-06-02, 84-06-03, 84-06-04, 84-06-05, 84-06-06, 84-06-07, 84-06-08, 84-06-09, 84-06-10, 84-06-11, 84-09 and 84-10.
- PCPro and WebPro have been enhanced allowing T1/ISDN layer 1 status, System Alarms and SRAM information to be viewed. The SRAM displays Day/Night Mode information, Trunk information (Trunk to Trunk Transfer Set/Not Set, Trunk disabled), Read List, Department Group information (DND, Transfer settings) and Extension information (Forwarding settings, Alarm settings, DND, BGM and more).



REFERENCE

Refer to the **UNIVERGE SV9100 PC Programming Manual, Appendix L - Maintenance Features** for details.

- WebPro supports remote upgrade and is only available in the Manufacture (MF) and Installer (IN) level logins.
- WebPro supports Backup of the system data and also the restoring of a Backup.
  - Backup data is saved with a .pcpx file extension.
  - When the Backup is restored, the system resets after the upload is completed.

- Only available in Manufacture (MF), Installer (IN), and System Administrator 1 (SA1) level logins.
- When other users are logged in by WebPro or Handset programming, the backup or restoration of system data cannot be performed.
- During Netlink Replication Web/PC Programming or Handset Programming is not accessible.
- With Version 3000, PC Programming displays the Power Factor for Boards and Terminals per chassis.
- PCPro uses system data to calculate the Power Factor and does not consider if hardware is installed. If system data shows a hardware, the power factor is calculated even if the hardware is not actually installed.
- With Version 3000 or higher software, DIM Commands Mail In 0 0 0 0 and Mail In 0 0 1 2 are enabled regardless of the setting in WebPro.



## Outbound IP Connection

### Description

Outbound IP Connection for PC Programming allows the system to make a PC Pro Connection via an outgoing call over IP, to a preprogrammed IP Address, upon receipt of an incoming CO call matching a preprogrammed CLI. When the target number of DID incoming call matches with the service code of 'Outbound IP Connection' the SV9100 compares the received CLI with the registered CLI (Program 90-69-03). When the received caller ID and registered caller ID match, the SV9100 sends a TCP establishment request to a waiting PCPro application. When the caller ID does not match, the call will either step to the locations in Program 22-11-05 and Program 22-11-06 if configured or, send a busy tone to the caller. Alternatively, via dialing service code from a Multiline Terminal, an outgoing IP connection can be made to a waiting PCPro terminal with a preprogrammed IP Address. This allows for a pre-authorized connection for programming purposes without using CO Lines and potentially reducing the cost of calls for maintenance. The outgoing IP call connects by sending a TCP establishment request to a waiting PC Programming terminal. A fixed, encrypted, user ID and password are used to verify the connection.

If an unsuccessful connection attempt is made, this can be output as an alarm.

### Conditions

- SV9100 system software supports Outbound IP Connection (PC Programming required).
- Outbound IP Connection for programming is not available when an existing WebPro/PCPro or station programming session is active.
- SV9100 changes the port number of TCP at each connection. The range used is 61050~61099.
- Outbound IP Connection Service code can be dialed across CCIS.
- Outbound IP Connection to a secondary side of Net-Link is not supported.

### Default Settings

None

## System Availability

### Terminals

All Terminals

### Required Software

None

### Required Component(s)

- CPU
- PC Programming

### Related Features

- ↪ **Alarm Reports**
- ↪ **Direct Inward Dialing (DID)**

### Guide to Feature Programming

The **Level 1**, **Level 2** and **Level 3** columns indicate the programs that are assigned when programming this feature in the order they are most commonly used. These levels are used with PCPro and WebPro wizards for feature programming.

- Level 1 – these are the most commonly assigned programs for this feature.
- Level 2 – these are the next most commonly assigned programs for this feature.
- Level 3 – these programs are not often assigned and require an expert level working knowledge of the system to be properly assigned.

◇ *The items highlighted in gray are read only and cannot be changed.*

#### PC Programming:

Program Number	Program Name/Description	Input Data	Default	Level		
				1	2	3
10-12-01	<b>GCD-CP10 Network Setup – IP Address</b> Assign the IP Address.	0.0.0.0 ~ 126.255.255.254 128.0.0.1 ~ 191.255.255.254 192.0.0.1 ~ 223.255.255.254	192.168.0.10	✓		

Program Number	Program Name/Description	Input Data	Default	Level		
				1	2	3
10-12-02	<p><b>GCD-CP10 Network Setup – Subnet Mask</b></p> <p>The setting of Subnet Mask is invalid when all Host Addresses are 0. If the network section is: 0, 127, 128.0, 191.255, 192.0.0, 223.255.255 The setting of Subnet Mask is invalid.</p>	128.0.0.0   192.0.0.0   224.0.0.0  240.0.0.0   248.0.0.0   252.0.0.0  254.0.0.0   255.0.0.0  255.128.0.0   255.192.0.0  255.224.0.0   255.240.0.0  255.248.0.0   255.252.0.0  255.254.0.0   255.255.0.0  255.255.128.0   255.255.192.0  255.255.224.0   255.255.240.0  255.255.248.0   255.255.252.0  255.255.254.0   255.255.255.0  255.255.255.128  255.255.255.192  255.255.255.224  255.255.255.240  255.255.255.248  255.255.255.252  255.255.255.254  255.255.255.255	255.255.0.0	✓		
10-12-03	<p><b>GCD-CP10 Network Setup – Default Gateway</b></p> <p>Assign the default gateway IP address for the GCD-CP10.</p>	0.0.0.0 ~ 126.255.255.254 128.0.0.1 ~ 191.255.255.254 192.0.0.1 ~ 223.255.255.254	0.0.0.0	✓		
11-15-14	<p><b>Service Code Setup, Administrative (for Special Access) – Modem Access</b></p> <p>Assign the service code to be used to access the internal modem on the GCD-CP10.</p>		740		✓	
22-02-01	<p><b>Incoming Call Trunk Setup</b></p> <p>Define the service type for the trunk intended to access the internal modem as 4:DIL.</p>	0 = Normal 1 = VRS (second dial tone if no VRS installed) 2 = DISA 3 = DID 4 = DIL 5 = E&M Tie line 6 = Delayed VRS 7 = ANI/DNIS 8 = DID(DDI) Mode Switching	0	✓		
22-07-01	<p><b>DIL Assignment</b></p> <p>Assign the Modem Access service code set in Program 11-15-14 as the destination extension for the DIL trunk for modem access.            ➡ For this selection to work, set Program 22-02-01 to 4 (DIL).</p>	Day/Night Modes (1 ~ 8): Extension Number (maximum of eight digits) Pilot Number	No Setting		✓	
90-02-01	<p><b>Programming Password Setup – User Name</b></p> <p>Set the system passwords.</p>	Maximum of 10 characters.	Refer to the Programming Manual for default values.		✓	

Program Number	Program Name/Description	Input Data	Default	Level		
				1	2	3
90-02-02	<b>Programming Password Setup – Password</b> Configure the administrator accounts that are used when connecting to the KTS via PCPro/ WebPro. If using PCPro, these are the accounts that are used to <i>connect</i> . If using WebPro, these are the accounts that are used to login.	Maximum of eight digits.	Refer to the Programming Manual for default values.		✓	
90-02-03	<b>Programming Password Setup – User Level</b> Set the system password user levels.	0 = Prohibited User 1 = MF (Manufacturer Level) 2 = IN (Installer Level) 3 = SA (System Administrator Level 1) 4 = SB (System Administrator Level 2) 5 = UA (User Programming Level 1)	Refer to the Programming Manual for default values.		✓	
90-26-01	<b>Program Access Level Setup – Maintenance Level</b> Define access levels to each program. This program defines which administrator accounts in Program 90-02 can access the program. If a program is not accessible, it does not appear in PCPro/WebPro.	1 = MF Level 2 = IN Level 3 = SA Level 4 = SB Level	Refer to the Level indication for each individual program (located in the upper left corner at the beginning of each program).		✓	
90-28-01	<b>User Programming Password Setup – Password</b> Use to set the password to enter the user programming mode.	Maximum of eight digits Fixed four digits	1111		✓	

**Outbound IP Connection:**

Program Number	Program Name/Description	Input Data	Default	Level		
				1	2	3
10-03-01	<b>ETU Setup</b> Set up and confirm the basic configuration data for each blade. This program represents different data depending on the blade installed in the slot. Refer to the SV9100 Programming Manual for a more detailed description of this program.	The assigned data varies depending on the blade installed in the slot.	Refer to the Programming Manual for default values for a more detailed description of the 10-03-XX programs.		✓	

Program Number	Program Name/Description	Input Data	Default	Level		
				1	2	3
11-15-16	<p><b>Service Code Setup, Administrative (for Special Access) – Outbound IP Connect for Programming</b></p> <p>Assign the service code for Outbound IP Connection for Programming. This Service Code is used to invoke TCP establishment request from SV9100 to remote PCPro.</p>		No Setting	✓		
90-10-01	<p><b>System Alarm Setup – Alarm Type</b></p> <p>Indicates the alarm type for Failure of Outbound IP Connection for PC Programming.</p>	<p>0 = Not Set                      1 = Major Alarm                      2 = Minor Alarm</p>	<p>Alarm 58:                      Failure of Connection (Outbound IP Connection)                      Adding parameter:                      01: Programming session is already active                      02: Not setting of IP Address or Port                      03: Caller ID is not match.                      10: Failure of getting IP Address.                      11: Socket Open Error 12: Socket Port Setting Error.                      13: TCP Session Timeout</p>		✓	
90-36-01	<p><b>Firmware Update Time Setting – Firmware Update Schedule Time</b></p> <p>Read Only program.</p>	<p>Year: 0 ~ 99                      Month: 0 ~ 12                      Day: 00 ~ 31                      Hour: 00 ~ 23                      Minute: 00 ~ 59</p>	No Setting		✓	
90-36-02	<p><b>Firmware Update Time Setting – Update Mode</b></p> <p>Read Only program.</p>	<p>0 = Non Active                      1 = Activated</p>	No Setting		✓	
90-36-03	<p><b>Firmware Update Time Setting – Update Report</b></p> <p>Read Only program.</p>	Maximum of 256 characters.	No Setting		✓	
90-69-01	<p><b>Outbound IP Connection Setup – Port Number</b></p> <p>Define the port number used for Outbound IP Connection for Programming.</p>	1 ~ 65535	8000		✓	

Program Number	Program Name/Description	Input Data	Default	Level		
				1	2	3
90-69-02	<b>Outbound IP Connection Setup – IP Address</b> Define the IP Address that the System will make the TCP establishment request to. I.E. the IP address of the PC with the waiting PC Programming.	0.0.0.0 ~ 255.255.255.255	0.0.0.0	✓		
90-69-03	<b>Outbound IP Connection Setup – Caller ID</b> Define Caller ID number that the system to compare with received Caller ID.	Maximum of 16 digits (0 ~ 9, *, #9)	No Setting	✓		

## Operation

### Outbound IP Connection

1. Open PC Pro on PC that has same IP address as assigned in Program 90-69-02.
  2. Go to **Communications/Connect**.
  3. Select **Outbound IP**.
  4. Input **Connection** port (same as Program 90-69-01).
  5. Select **Connect**.
    - ◇ *When PCPro does not receive a TCP established request within three minutes (fixed time), it ends the state of "Attempting to Connect".*
  6. Dial **Outbound IP Connection Service Code** (Program 11-15-16).
- OR-**
7. Call the **DID** that points to the **Outbound IP Connection Service Code** (Program 11-15-16) with the matching CID (Program 90-69-03).
  8. After connection hang up.



*Refer to the UNIVERGE SV9100 PC Programming Manual for further operational details.*

**PCPro and WebPro Comparison**

The table below gives a quick feature comparison of PCPro and WebPro.



*For additional details refer to the UNIVERGE SV9100 PC Programming Manual.*

Table 2-95 PCPro and WebPro Comparison

Feature		Feature Application		Comments
		PCPro	WebPro	
<b>Installation Program</b>		Y	–	
<b>File Handling</b>	File New/Open/Save/Save As	Y	–	
	File Properties	Y	–	PCPro supports save/view/modify UNIVERGE SV9100 Site Information, password protect files, add notes, connection settings.
	Version Conversion	Y	–	PCPro can convert databases between different UNIVERGE SV9100 versions.
<b>Programming Modes</b>	Offline	Y	–	Ability to program offline and upload to the UNIVERGE SV9100 at a later date.
	Live Update	Y	Y	Changes made in WebPro apply immediately. No upload is required. PCPro has Interactive Mode to make live changes.
<b>Remote Connection</b>	Upload	Y	–	PCPro can download the database from the UNIVERGE SV9100 to allow backups.
	Download	Y	–	
	Connection Accounts	Y	–	PCPro supports Direct, Modem and IP connections. WebPro supports only IP.
<b>Accounts</b>		Y	Y	WebPro: Refer to Program 90-02 in the Programming Manual.

Table 2-95 PCPro and WebPro Comparison (Continued)

Feature		Feature Application		Comments
		PCPro	WebPro	
Programming	Screen Help Text: System Data Help Text	Y	Y	Help in WebPro is more simplified than in PCPro.
	Control Hint Text	Y	Y	
	Smart Links	Y	–	WebPro has more simplified links than PCPro.
	Smart Labels	Y	Y	WebPro has more simplified labels than PCPro.
	Smart Controls	Y	–	WebPro has more simplified controls than PCPro.
	Validation	Y	Y	
	Multi-Assignments: Extension Numbers	Y	–	PCPro provides special screens that allow multiple values to be set easily. This applies mainly to table data. These screens shorten the programming time.
	Line Keys (CAP)	Y	–	
	Line Keys (General)	Y	–	
	Account Codes	Y	–	
	Defaults: View	Y	–	
	Copy: System Data Level	Y	Y	Copy items in an individual program.
	Group Level	Y	Y	Copy data for ports (telephone/trunk).
Modification Tracking (See also Modification History.)	Y	–	PCPro keeps track of changes made to a database. This includes: <ol style="list-style-type: none"> <li>1. Changes made to a database that are not yet saved.</li> <li>2. Changes made to database that are not yet uploaded.</li> </ol>	
Wizards		Y	Y	



Table 2-95 PCPro and WebPro Comparison (Continued)

Feature		Feature Application		Comments
		PCPro	WebPro	
<b>Configuration Screens</b>	Blade Configuration	Y	–	PCPro provides special screens that shorten the programming time to setup core UNIVERGE SV9100 features.
	Class of Service	Y	–	
	Night Mode Switching	Y	–	
	Trunk Access Maps	Y	–	
	Trunk Groups	Y	–	
	Department Groups	Y	–	
	Direct Inward Dialing	Y	–	
	Ring Groups	Y	–	
	Timers (Trunk/Telephone)	Y	–	
<b>QuickSearch</b>		Y	Y	WebPro has a simplified search facility. It applies only to programs. PCPro provides extensive searching on programs, Wizards and IPK cross-referencing.
<b>Reports</b>	System Data	Y	–	PCPro can generate various reports based on values in the database.
	Verify	Y	–	
	Maintenance	Y	–	
	CAP Keys	Y	–	
	Numbering Plan	Y	–	
	Class of Service	Y	–	
	Modification History	Y	–	
<b>Simulators</b>	LCR/ACR	Y	–	
<b>Import/Export</b>	Speed Dials	Y	–	PCPro allows import/export of speed dials (csv file). It can also import converted IPK databases.
	IPK Converted File	Y	–	
<b>Program Help</b>	Help Pages	Y	Y	WebPro has more simplified help than PCPro.
	Context Sensitive Help	Y	Y	

Table 2-95 PCPro and WebPro Comparison (Continued)

Feature		Feature Application		Comments
		PCPro	WebPro	
<b>Security</b>	Application Login	Y	Y	User name/password protection to login to PCPro/WebPro.
	KTS Connection Login	Y	–	PCPro connections to a UNIVERGE SV9100 are user name/password protected.
	File Open	Y	–	You can password protect a PCPro saved database.
<b>Debug/Capture</b>	GCD-CP10 Debug Capture	Y	–	PCPro provides a tool for capturing debug information from the UNIVERGE SV9100 GCD-CP10.
	SMDR Capture	Y	–	PCPro provides a tool for capturing SMDR reports from the UNIVERGE SV9100.
<b>Modification History</b>		Y	–	PCPro keeps a running list of all the modifications made to a system databases. It also tracks uploads/downloads.
<b>System Initialize</b>		Y	Y	This is the ability to initialize the UNIVERGE SV9100.
<b>System Time Setting</b>		Y	Y	This sets the time on the UNIVERGE SV9100.
<b>Software Updates</b>	Firmware Upload	Y	–	The UNIVERGE SV9100 GCD-CP10 firmware can be upgraded via PCPro.
<b>Licensing / Feature Activation</b>	KTS Feature Activation	Y	Y	Licensed UNIVERGE SV9100 features can be activated via PCPro/WebPro. You can also see what is licensed.

## PC Programming – Security

### Description

With Version 6000 or higher, MF Level access is now controlled through system data and if user continuously enters the wrong ID/Password from TEL Pro/User Pro/Web Pro/PC Pro then the access will be restricted for the defined time.

### Conditions

- If accessing TelPro/UserPro/WebPro/PCPro with wrong ID or Password for more than the number of times set in Program 10-73-02 and the time interval set in Program 10-73-01, access is restricted for the time set in Program 10-73-03.
- MF level access restriction is not applicable for the applications which use XML access (For Example: UC Suite).
- When Program 10-73-01 is set to 0, it does not restrict the access.
- The access from TelPro/UserPro is individually applicable to each port.
- The input count and access restriction is applicable for TelPro/UserPro collectively.
- The input count and access restriction is applicable for WebPro/PCPro collectively.
- The input mistake count is reset when successful access occurs or at the time when access restriction starts.
- When access is restricted, display of TelPro/UserPro/WebPro/PCPro is same as at the time of wrong ID/Password is entered.
- An alarm (49) will be generated at the time of the access restriction starts and releases.



NOTE

— *With SV9100 V6000, Alarm(49) is not displayed on MLT. It is only reported in the System Alarm Report.*

- Data set in Program 10-73 of NetLink Primary system is replicated to Secondary system.

### Default Settings

MF level access is enabled.

## System Availability

### Terminals

All Terminals

### Required Component(s)

0416 – SV9100 Version Lic (R6)

## Related Features

None

## Guide to Feature Programming

The **Level 1**, **Level 2** and **Level 3** columns indicate the programs that are assigned when programming this feature in the order they are most commonly used. These levels are used with PCPro and WebPro wizards for feature programming.

- Level 1 – these are the most commonly assigned programs for this feature.
- Level 2 – these are the next most commonly assigned programs for this feature.
- Level 3 – these programs are not often assigned and require an expert level working knowledge of the system to be properly assigned.

Program Number	Program Name/Description	Input Data	Default	Level		
				1	2	3
10-73-01	<b>Access Control of System Data – Monitoring Time</b> Set the monitoring time to monitor the inputs.	0 = Disable this feature 1~255(sec)	60	✓		
10-73-02	<b>Access Control of System Data – Miss Number</b> Set the number of input tries within the defined time set in Program 10-73-01.	1~128	3	✓		
10-73-03	<b>Access Control of System Data – Restrict Time</b> Set the time to restrict the access.	1~255: 10~2550(sec)	6	✓		
10-73-04	<b>Access Control of System Data – MF Access</b> Allow/Deny the MF access.	0 = Deny 1 = Access	1	✓		
90-10-01	<b>System Alarm Setup – Alarm Type</b> Set the alarm type 49.	0 = Not Set 1 = Major Alarm 2 = Minor Alarm	1	✓		

Operation

None

## PC Programming – WebPro HTTPS Support

### Description

With Version 4000 or higher, web programming of SV9100 supports both HTTP and HTTPS protocol between web browser and SV9100 system.

With HTTP protocol, web page is transferred as plain text and web programming has a risk of customer data being sniffed. Therefore HTTPS protocol is used with web programming for transferring data between PC and SV9100 in encrypted form for secure transmission of data.

Figure 2-74 Example of HTTPS Encryption

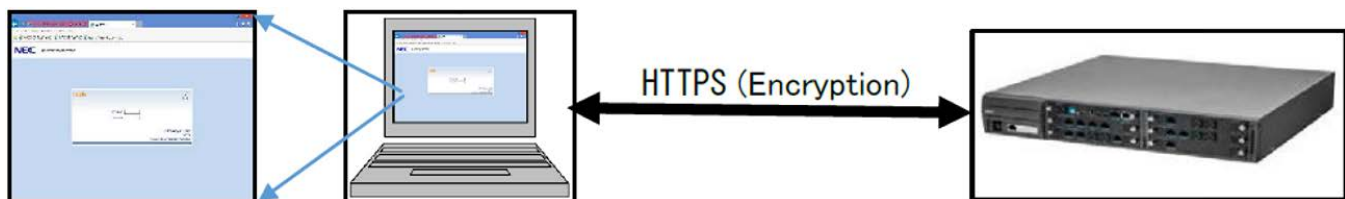

HTTPS is supported with the following applications:

- Web Programming
- User Programming

### Conditions

- TLSv1 version is supported for HTTPS with SV9100.
- Program 10-12-20 (SSLv3 Setting) can be used to enable or disable SSLv3, but Web Programming HTTPS does not read this data and works only with TLSv1.
- Web Programming supports both HTTP and HTTPS protocol simultaneously.
- WebPro is accessed using HTTP with URL `http://(IP Address of the SV9100 or NetBIOS Name)`.
- WebPro is accessed using HTTPS with URL `https://(IP Address of the SV9100 or NetBIOS Name)`.
- Default HTTPS port is 443, if this port is changed from 443; it is required to input TCP port in address bar. WebPro is accessed by using URL `https://(IP Address of the SV9100 or NetBIOS Name):Port`.
- When Web Programming HTTPS TCP port is changed by using program 90-54-03, the changed TCP port is applied when all users log out.
- HTTPS access is not available, if program 90-54-03 is set to 0. HTTPS access is available by setting this program to 1~65535.

### Default Settings

None

### System Availability

#### Terminals

None

#### Required Component(s)

- GCD-CP10
- GPZ-IPLE

### Related Features

↳ [PC Programming](#)

### Guide to Feature Programming

The **Level 1**, **Level 2** and **Level 3** columns indicate the programs that are assigned when programming this feature in the order they are most commonly used. These levels are used with PCPro and WebPro wizards for feature programming.

- Level 1 – these are the most commonly assigned programs for this feature.
- Level 2 – these are the next most commonly assigned programs for this feature.
- Level 3 – these programs are not often assigned and require an expert level working knowledge of the system to be properly assigned.

Program Number	Program Name/Description	Input Data	Default	Level		
				1	2	3
10-12-01	<b>GCD-CP10 Network Setup – IP Address</b> Assign the IP Address.	0.0.0.0 ~ 126.255.255.254 128.0.0.1 ~ 191.255.255.254 192.0.0.1 ~ 223.255.255.254	192.168.0.10	✓		

Program Number	Program Name/Description	Input Data	Default	Level		
				1	2	3
10-12-02	<b>GCD-CP10 Network Setup – Subnet Mask</b> The setting of Subnet Mask is invalid when all Host Addresses are 0. If the network section is: 0, 127, 128.0, 191.255, 192.0.0, 223.255.255 The setting of Subnet Mask is invalid.	128.0.0.0   192.0.0.0   224.0.0.0  240.0.0.0   248.0.0.0   252.0.0.0  254.0.0.0   255.0.0.0  255.128.0.0   255.192.0.0   255.224.0.0   255.240.0.0  255.248.0.0   255.252.0.0  255.254.0.0   255.255.0.0   255.255.128.0   255.255.192.0  255.255.224.0   255.255.240.0  255.255.248.0   255.255.252.0  255.255.254.0   255.255.255.0   255.255.255.128  255.255.255.192  255.255.255.224  255.255.255.240  255.255.255.248  255.255.255.252  255.255.255.254  255.255.255.255	255.255.255.0		✓	
10-12-03	<b>GCD-CP10 Network Setup – Default Gateway</b> Assign the default gateway IP address for the GCD-CP10.	0.0.0.0 ~ 126.255.255.254 128.0.0.1 ~ 191.255.255.254 192.0.0.1 ~ 223.255.255.254	0.0.0.0		✓	
10-12-09	<b>GCD-CP10 Network Setup – IP Address</b> Set IP address for GPZ-IPL.E.	0.0.0.0 ~ 126.255.255.254 128.0.0.1 ~ 191.255.255.254 192.0.0.1 ~ 223.255.255.254	172.16.0.10	✓		
10-12-10	<b>GCD-CP10 Network Setup – Subnet Mask</b> Set the subnet mask of the GPZ-IPL.E.	128.0.0.0   192.0.0.0   224.0.0.0  240.0.0.0   248.0.0.0   252.0.0.0  254.0.0.0   255.0.0.0  255.128.0.0   255.192.0.0  255.224.0.0   255.240.0.0  255.248.0.0   255.252.0.0  255.254.0.0   255.255.0.0  255.255.128.0   255.255.192.0  255.255.224.0   255.255.240.0  255.255.248.0   255.255.252.0  255.255.254.0   255.255.255.0  255.255.255.128  255.255.255.192  255.255.255.224  255.255.255.240  255.255.255.248  255.255.255.252  255.255.255.254  255.255.255.255	255.255.0.0		✓	
10-62-01	<b>NetBIOS Setting – NetBIOS Mode</b> Enable/Disable NetBIOS mode.	0 = Disable 1 = Enable	1	✓		
10-62-02	<b>NetBIOS Setting – NetBIOS Name</b> Assign NetBIOS name.	Maximum of 15 characters	SV9100	✓		



Program Number	Program Name/Description	Input Data	Default	Level		
				1	2	3
90-54-01	<b>PC/Web Programming – WebPro TCP Port Number</b> Assign TCP WebPro port number.	0 ~ 65535	80	✓		
90-54-02	<b>PC/Web Programming – PCPro TCP Port Number</b> Assign TCP PCPro port number.	0 ~ 65535	8000	✓		
90-54-03	<b>PC/Web Programming – Web Programming TCP Port (HTTPS)</b> Assign Web programming TCP port (HTTPS) number.	0 ~ 65535 0 = HTTPS access is not available	443	✓		

## Operation



*Refer to the SV9100 PCPro Manual for information regarding certificate installation.*

## Description

With SV9100 Version 4000 or higher, the Lua-based application PhonePro is supported. Similar to the applications on iOS or Android, Lua applications can be installed on the SV9100 CPU and run concurrently with the SV9100's native software.

PhonePro allows a SV9100 phone user to program certain features on a telephone using a web based application. PhonePro utilizes NECs XML Pro to query certain settings for the SV9100 telephone and assign new functions to the phone. PhonePro provides a graphical user interface showing the current settings on the SV9100 digital or IP phone, allowing the user to assign features and values on the programmable buttons of their phone.

Items that can be set through PhonePro include: UC Password, the phone name, call forwarding, ring tones, feature keys, feature key labels and various InMail options.

In addition to viewing and assigning features on the programmable buttons, PhonePro can print out a Desi label sheet that can be cut to size to place above each row of programmable buttons

## Conditions

- In a NetLink network, PhonePro only supports connecting to the main system. PhonePro does not support connecting to remote systems in a NetLink network.
- The Lua Application Manager and PhonePro application do not support HTTPS.
- An available Standard or Premium level user license is required for each user to access PhonePro. The application enforces this by checking for an available UC Client license (5305) when a user attempts to login to PhonePro.
- When a users logs into PhonePro, they must use a username and password combination from Program 20-59.
- PhonePro is accessible from PCs as well as mobile devices.
- The maximum number of characters for the phone name is 12 characters.
- The maximum number of characters for each label name is 10 characters.
- The following list of features can be assigned to the buttons in PhonePro:
  - None
  - One Touch
  - Do Not Disturb (DND)
  - Background Music
  - Headset
  - Incoming Caller ID List

- Call Forward Immediate
  - Call Forward Busy/No Answer
  - Call Forward Both Ring
  - Call Pickup for Own Group
  - System Speed Dial
  - Group Speed Dial
  - Call Redirect
  - Live Record
  - Live Monitor
  - Intercom
- When displaying Call Forward settings after launching the PhonePro application, or refreshing the browser, the Call Forward state shows the current value in Program 24-09-01. The Forwarding# field displays the following:
- No Call Forward – the field is blank.
  - Call Forward Both Ring – if the values for Programs 24-09-02 and 24-09-03 are the same, this value is displayed. If the values are different, **Click for info** is displayed in the field.
  - Call Forward All Calls – if the values for Programs 24-09-02 and 24-09-03 are the same, this value is displayed. If the values are different, **Click for info** is displayed in the field.
  - Call Forward Busy/No Answer – if the values for Programs 24-09-02, 24-09-03, 24-09-04 and 24-09-05 are the same, this value is displayed. If the values are different, **Click for info** is displayed in the field.
  - Call Forward Busy – if the values for Programs 24-09-04 and 24-09-05 are the same, this value is displayed. If the values are different, **Click for info** is displayed in the field.
  - Selecting **Click for info** displays the following pop-up message: “Multiple phone numbers are set for this feature. To edit any one of them, use WebPro. To set them all to one number, use this form”.

## Default Settings

At default, the SV9100 does not have the PhonePro application installed.

## System Availability

### Terminals

- SV9100 Digital and IP terminals
- Softphone

### Required Component(s)

- Lua Application Manager 1.1.5
- 3514 – SV9100 Lua PhonePro Lic
- 0414 – SV9100 Version Lic (R4)
- Standard or Premium User license
- Web Browser

### Related Features

None

### Guide to Feature Programming

The **Level 1**, **Level 2** and **Level 3** columns indicate the programs that are assigned when programming this feature in the order they are most commonly used. These levels are used with PCPro and WebPro wizards for feature programming.

- Level 1 – these are the most commonly assigned programs for this feature.
- Level 2 – these are the next most commonly assigned programs for this feature.
- Level 3 – these programs are not often assigned and require an expert level working knowledge of the system to be properly assigned.

Program Number	Program Name/Description	Input Data	Default	Level		
				1	2	3
10-12-01	<b>GCD-CP10 Network Setup – IP Address</b> Assign the IP Address.	0.0.0.0 ~ 126.255.255.254 128.0.0.1 ~ 191.255.255.254 192.0.0.1 ~ 223.255.255.254	192.168.0.10	✓		

Program Number	Program Name/Description	Input Data	Default	Level		
				1	2	3
10-12-02	<p><b>GCD-CP10 Network Setup – Subnet Mask</b></p> <p>The setting of Subnet Mask is invalid when all Host Addresses are 0. If the network section is: 0, 127, 128.0, 191.255, 192.0.0, 223.255.255 The setting of Subnet Mask is invalid.</p>	128.0.0.0   192.0.0.0   224.0.0.0  240.0.0.0   248.0.0.0   252.0.0.0  254.0.0.0   255.0.0.0  255.128.0.0   255.192.0.0   255.224.0.0   255.240.0.0  255.248.0.0   255.252.0.0  255.254.0.0   255.255.0.0   255.255.128.0   255.255.192.0  255.255.224.0   255.255.240.0  255.255.248.0   255.255.252.0  255.255.254.0   255.255.255.0   255.255.255.128  255.255.255.192  255.255.255.224  255.255.255.240  255.255.255.248  255.255.255.252  255.255.255.254  255.255.255.255	255.255.255.0		✓	
10-12-03	<p><b>GCD-CP10 Network Setup – Default Gateway</b></p> <p>Assign the default gateway IP address for the GCD-CP10.</p>	0.0.0.0 ~ 126.255.255.254 128.0.0.1 ~ 191.255.255.254 192.0.0.1 ~ 223.255.255.254	0.0.0.0		✓	
10-12-09	<p><b>GCD-CP10 Network Setup – IP Address</b></p> <p>Set IP address for GPZ-IPLE.                      ➡ The IP Address assigned in Program 10-12-01 cannot start with the same leading digits as the IP Address assigned here.</p>	0.0.0.0 ~ 126.255.255.254 128.0.0.1 ~ 191.255.255.254 192.0.0.1 ~ 223.255.255.254	172.16.0.10	✓		
10-12-10	<p><b>GCD-CP10 Network Setup – Subnet Mask</b></p> <p>Set the subnet mask of the GPZ-IPLE.</p>	128.0.0.0   192.0.0.0   224.0.0.0  240.0.0.0   248.0.0.0   252.0.0.0  254.0.0.0   255.0.0.0  255.128.0.0   255.192.0.0  255.224.0.0   255.240.0.0  255.248.0.0   255.252.0.0  255.254.0.0   255.255.0.0  255.255.128.0   255.255.192.0  255.255.224.0   255.255.240.0  255.255.248.0   255.255.252.0  255.255.254.0   255.255.255.0  255.255.255.128  255.255.255.192  255.255.255.224  255.255.255.240  255.255.255.248  255.255.255.252  255.255.255.254  255.255.255.255	255.255.0.0		✓	

## Operation



REFERENCE

*Refer to the SV9100 PhonePro User Guide for additional information.*

## Power Failure Transfer

### Description

Power Failure Transfer ensures that a customer has access to the Central Office network during a power outage. The CO/PBX tip and ring are automatically transferred to a DTL or ITL terminal multiline terminal with a PSA-L adapter installed.



REFERENCE

*Refer to the UNIVERGE SV9100 System Hardware Manual for the MDF Pin Numbers and PFT Connections (Power Failure Transfer Relay 1).*

### Conditions

- The PSA-L is not supported on DTL-2E-1, DTL-6DE-1, ITL-2E-1 and ITL-6DE-1 terminals.
- The single line telephones that are installed must provide dialing signal accepted by the outside exchange (Dial Pulse or Dual Tone Multifrequency).
- Multiline telephones with PSA-L adapter or single line telephones cross-connected at the MDF can be used for this feature.
- Single Line or PSA-L equipped multiline telephones and outside lines connected during power failure are fixed one-to-one.
- Single line telephones must be equipped with a ground start button for use with Ground Start Trunks.
- System features cannot be activated from single line telephone or multiline telephone with PSA-L adapter when Power Failure Transfer is in operation.
- When power is restored to the system one of the following happens depending on which telephone (a single line telephone or multiline telephone with PSA-L adapter) is used:
  - Single Line Telephones
    - Power Failure Transfer is cancelled. Calls in progress on Power Failure Transfer lines are disconnected.
  - Multiline Telephones with PSA-L Adapter
    - Calls in progress continue but the display does not show the date, time and system softkeys. When the user hangs up, the phone automatically switches to Digital mode and the display returns to normal.
- The PSA-L adapter can be set to send DTMF or DP.
- The PSA-L is supported on Loop Start Trunks only.
- A Power Fail circuit is required. The GCD-4COTB has Power Failure circuits on the first two ports.
- The GPZ-4COTF daughter board does not have Power Fail or Fax Branch Exchange circuits.

### Default Settings

None

### System Availability

#### Terminals

All Multiline Terminals

#### Required Component(s)

- PSA-L Handset Adapter
- GCD-4COTB

### Related Features

None

### Guide to Feature Programming

The **Level 1**, **Level 2** and **Level 3** columns indicate the programs that are assigned when programming this feature in the order they are most commonly used. These levels are used with PCPro and WebPro wizards for feature programming.

- Level 1 – these are the most commonly assigned programs for this feature.
- Level 2 – these are the next most commonly assigned programs for this feature.
- Level 3 – these programs are not often assigned and require an expert level working knowledge of the system to be properly assigned.

Program Number	Program Name/Description	Input Data	Default	Level		
				1	2	3
14-02-09	<b>Analog Trunk Data Setup – Busy Tone Detection</b> Set the basic options for each analog trunk port.	0 = Disable 1 = Enable	0	✓		
14-02-14	<b>Analog Trunk Data Setup – Loop Start/ Ground Start</b> Set the basic options for each analog trunk port.	0 = Loop Start (Loop) 1 = Ground Start (Ground)	0	✓		



Operation

None

## Prime Line Selection

### Description

Prime Line Selection allows a multiline terminal user to place or answer a call over a specific trunk by lifting the handset. The user does not have to press keys or dial codes. This simplifies handling calls on a frequently used trunk.

Prime Line Selection has the following two modes of operation:

- Outgoing Prime Line Preference**  
Lifting the handset seizes the Prime Line. Outgoing Prime Line Preference would help a telemarketer who always needs a free line to call prospective clients. The telemarketer lifts the handset and the Prime Line is always available. (Outgoing Prime Line Preference may be affected by Incoming Prime Line Preference – refer to the Programming section of this feature.)
- Incoming Prime Line Preference**  
When the Prime Line rings the extension, lifting the handset answers the call. Incoming Prime Line Preference could benefit the Service Department dispatcher who must quickly answer customer's service calls and then dispatch repair technicians. When a customer calls in, the dispatcher lifts the handset to get their call. (Incoming Prime Line Preference can optionally seize an idle line appearance – refer to the Programming section of this feature.)

### Conditions

- Prime Line Selection can be assigned for Wireless DECT (SIP) and single line telephones (Analog 500/2500), however, the telephones cannot access ICM dial tone.
- Prime Line Selection directly interacts with line preference.

### Default Settings

Disabled

### System Availability

#### Terminals

All Terminals

#### Required Component(s)

None

## Related Features

- ➔ [Central Office Calls, Placing](#)
- ➔ [Direct Inward Dialing \(DID\)](#)
- ➔ [Direct Inward Line \(DIL\)](#)
- ➔ [Direct Inward System Access \(DISA\)](#)
- ➔ [Line Preference](#)

## Guide to Feature Programming

The **Level 1**, **Level 2** and **Level 3** columns indicate the programs that are assigned when programming this feature in the order they are most commonly used. These levels are used with PCPro and WebPro wizards for feature programming.

- Level 1 – these are the most commonly assigned programs for this feature.
- Level 2 – these are the next most commonly assigned programs for this feature.
- Level 3 – these programs are not often assigned and require an expert level working knowledge of the system to be properly assigned.

Program Number	Program Name/Description	Input Data	Default	Level		
				1	2	3
14-05-01	<b>Trunk Group – Trunk Group Number</b> Assign Prime Line to a separate trunk group for outgoing Prime Line selection. (Also refer to Program 14-06 and Program 21-02.)	Trunk Port 1 ~ 400 Group Number 0 ~ 100 Priority 1 ~ 400	Default = Trunks 1 ~ 400 assigned to trunk group 1 with priorities equal to the trunk number. Trunk 1 = Priority 1 Trunk 400 = Priority 400.	✓		
14-06-01	<b>Trunk Group Routing – Priority Order Number</b> Set the priority order number 1 ~ 4.	0 = Not Specify 1 ~ 100: (Trunk Group Number) 101 ~ 150: (100 + Networking System Number) 1001 ~ 1100: (1000 + Route Table Number)	Route 1, Order Number 1 = 1 (Trunk Group 1) Order Numbers 2, 3, 4 = 0 (Not Specified) All Other Routes (2 ~ 100) and Order Numbers (1 ~ 4) = 0 (Not Specified)	✓		

Program Number	Program Name/Description	Input Data	Default	Level		
				1	2	3
14-07-01	<p><b>Trunk Access Map Setup – Trunk Port Number</b></p> <p>For outgoing Prime Line selection, assign each Prime Line trunk to a different Access Map and deny outbound access to all trunks except the Prime Line trunk.</p>	0 = No access 1 = Outgoing access only 2 = Incoming access only 3 = Access only when trunk on Hold 4 = Outgoing access and access when trunk on Hold 5 = Incoming access and access when trunk on Hold 6 = Incoming and Outgoing access 7 = Incoming access, outgoing access and access when trunk on Hold Trunk Access Maps: 1 ~ 400	Access Maps 1 ~ 400 = Trunk Ports 1 ~ 400 assigned with option 7 access (incoming and outgoing access and access when trunk is on Hold).	✓		
15-01-02	<p><b>Basic Extension Data Setup – Outgoing Trunk Line Preference</b></p> <p>Turn Off or On Outgoing Trunk Line Preference for extensions.</p>	0 = Off 1 = On	0	✓		
15-02-10	<p><b>Multiline Telephone Basic Data Setup – Ringing Line Preference for Trunk Calls</b></p> <p>Enter 1 if lifting the handset should answer ringing Prime Line; enter 0 to seize idle line appearance.</p>	0 = Idle (Off) 1 = Ringing (On)	1		✓	
15-06-01	<p><b>Trunk Access Map for Extensions</b></p> <p>Set assignment so extension(s) can have access to Prime Line. Deny outbound access to extensions that should not have Prime Line.</p>	Trunk Access Maps: 1 ~ 400	1	✓		
15-07-01	<p><b>Programmable Function Keys</b></p> <p>Assign a *00(ICM key) on phones to get an Intercom dial tone when both Programs 15-01-02 and 20-08-21 are turned on for the extension.</p>	Line Key 1 ~ 48 0 ~ 99 (Normal Function Code 751 by default) *00 ~ *99 (Appearance Function Code) (Service Code 752 by default)	Refer to the Programming Manual for default values.		✓	
21-02-01	<p><b>Trunk Group Routing for Extensions</b></p> <p>Assign extension(s) to a Prime Line route for outgoing Prime Line access.</p>	Trunk Groups: 1 ~ 100 Day/Night Mode: 1 ~ 8 Route Table Number: 0 ~ 100 (0 = No Setting)	1	✓		
22-01-01	<p><b>System Options for Incoming Calls – Incoming Call Priority</b></p> <p>Determine if Intercom calls or trunk calls have answer priority when both are ringing simultaneously.</p>	0 = Intercom call priority 1 = Trunk call priority	1		✓	

Program Number	Program Name/Description	Input Data	Default	Level		
				1	2	3
22-04-01	<b>Incoming Extension Ring Group Assignment</b> Assign extension(s) to a ring group that consists of a Prime Line.	Maximum of eight digits.	Extensions 101 ~ 108 (first eight ports) ring for incoming Ring Group 1 calls. No other extensions ring for incoming Ring Group 1 calls.		✓	
22-05-01	<b>Incoming Trunk Ring Group Assignment</b> Assign a Prime Line to a ring group.	Trunks 1 ~ 400 Incoming Group Number for Day/Night Mode (1 ~ 8): 0 = (No Setting) 001 ~ 100 = (Incoming Group) 102 = (In-Skin/ External Voice Mail or InMail)	1		✓	
20-08-21	<b>Class of Service Options (Outgoing Call Service) – Automatic Trunk Seizing by Pressing Speaker Key</b> Enable/Disable an extension user ability to automatically access Trunk Route when going Off-hook via the Speaker key.	0 = Off 1 = On	COS 1 ~ 15 = 0		✓	

## Operation

### To place a call on your Prime Line:

1. Lift the handset.
  - ◇ *You hear dial tone on your Prime Line.*

### To answer a call on your Prime Line:

1. Lift the handset.
  - ◇ *Depending on your Line Preference programming, you either answer the Prime Line or get dial tone on the idle line appearance.*

## Description

A Private Line is a trunk reserved for a multiline terminal for placing and answering calls. Users with a Private Line always know when important calls are for them. Additionally, the user has their own trunk for placing calls that are not available to others in the system.

### Conditions

- Incoming Only – The multiline terminal has a Private Line only for incoming calls. The user cannot place calls on the Private Line.
- Outgoing Only – The multiline terminal has a Private Line only for outgoing calls. The Private Line does not ring for incoming calls.
- Both Ways – The multiline terminal has a Private Line for both incoming and outgoing calls.
- Private Lines do not follow Call Forwarding if not Direct Inward Line (DIL).
- Other programmed options for outgoing calls also affect a Prime Line.
- Calls to extensions with DND active do not follow Call Forwarding programming. Direct Inward Line (DIL) calls ring an idle Department Group member, then follow Program 22-08 then Program 22-05.
- An extension user can have Line Preference options applied to their Private Line.
- A Private Line can also be a Prime Line.
- You should always program a line key for each Private Line.
- Private Lines are available on single line telephones.
- Private Lines follow normal Toll Restriction.
- An extension user can transfer their Private Line. If other users have hold access, the destination can answer the transferred Private Line and place it on Hold.
- NEC does not recommend assigning ringdown to a private line.

### Default Settings

Disabled

## System Availability

### Terminals

All Terminals

### Required Component(s)

None

## Related Features

- ↳ [Call Forwarding](#)
- ↳ [Central Office Calls, Placing](#)
- ↳ [Do Not Disturb](#)
- ↳ [Line Preference](#)
- ↳ [Prime Line Selection](#)
- ↳ [Programmable Function Keys](#)
- ↳ [Single Line Telephones, Analog 500/2500 Sets](#)
- ↳ [Transfer](#)
- ↳ [InMail](#)

## Guide to Feature Programming

The **Level 1**, **Level 2** and **Level 3** columns indicate the programs that are assigned when programming this feature in the order they are most commonly used. These levels are used with PCPro and WebPro wizards for feature programming.

- Level 1 – these are the most commonly assigned programs for this feature.
- Level 2 – these are the next most commonly assigned programs for this feature.
- Level 3 – these programs are not often assigned and require an expert level working knowledge of the system to be properly assigned.

Program Number	Program Name/Description	Input Data	Default	Level		
				1	2	3
14-01-09	<p><b>Basic Trunk Data Setup – Private Line</b> Determine if a trunk should be used as a Normal or Private line.</p> <p>➡ <i>A Private Line reserves a trunk for a multiline terminal for placing and answering calls. A user with a Private Line always knows when important calls are for them. Additionally, the user has their own trunk for placing calls that is not available to others in the system.</i></p>	0 = Disable Private Line (Normal) 1 = Enable Private Line (Private Line)	0	✓		
14-07-01	<p><b>Trunk Access Map Setup – Trunk Port Number</b> Assign Private Line to the Private Line Access Map (refer to Program 15-06 in this section). Use option 5 for Incoming, option 7 for Both Ways and option 4 for Outgoing. In all other Access Maps, assign option 3 to the Private Line.</p>	0 = No access 1 = Outgoing access only 2 = Incoming access only 3 = Access only when trunk on Hold 4 = Outgoing access and access when trunk on Hold 5 = Incoming access and access when trunk on Hold 6 = Incoming and Outgoing access 7 = Incoming access, outgoing access and access when trunk on Hold Trunk Access Maps: 1 ~ 400	Access Maps 1 ~ 400 = Trunk Ports 1 ~ 400 assigned with option 7 access (incoming and outgoing access and access when trunk is on Hold).		✓	
15-06-01	<p><b>Trunk Access Map for Extensions</b> Assign extension to have Private Line to an unused Private Line Access Map.</p>	Trunk Access Maps: 1 ~ 400	1		✓	
15-07-01	<p><b>Programmable Function Keys</b> Make sure extension has a line key (e.g., 012) for the Private Line.</p>	Line Key 1 ~ 48 0 ~ 99 (Normal Function Code 751 by default) *00 ~ *99 (Appearance Function Code) (Service Code 752 by default)	Refer to the Programming Manual for default values.		✓	
21-02-01	<p><b>Trunk Group Routing for Extensions</b> Change the routing as needed.</p>	1 ~ 100 (Trunk Groups) 0 ~ 100 (0 = No Setting)	1		✓	



Program Number	Program Name/Description	Input Data	Default	Level		
				1	2	3
22-02-01	<b>Incoming Call Trunk Setup</b> Set the Trunk Service to Type 4 if routing unanswered Private Lines to voice mail or 0 if not routing to voice mail.	Ring Groups: 1 ~ 100 0 = Normal 1 = VRS (second dial tone if no VRS installed) 2 = DISA 3 = DID 4 = DIL 5 = E&M Tie line 6 = Delayed VRS 7 = ANI/DNIS 8 = DID(DDI) Mode Switching	0	✓		
22-04-01	<b>Incoming Extension Ring Group Assignment</b> Assign extension to Private Line ring group. Set the ringing in Program 22-06 – use option 1 for Incoming or Both Way Private Lines. Use option 0 for Outgoing Private Lines. Do not assign any other extensions to the Private Line ring group.	Maximum of eight digits.	Extensions 101 ~ 108 (first eight ports) ring for incoming Ring Group 1 calls. No other extensions ring for incoming Ring Group 1 calls.		✓	
22-05-01	<b>Incoming Trunk Ring Group Assignment</b> Assign Private Line to an unused Private Line ring group (i.e., a ring group just for the Private Line).	Trunks 1 ~ 400 Incoming Group Number for Day/Night Mode (1 ~ 8): 0 = (No Setting) 001 ~ 100 = (Incoming Group) 102 = (In-Skin/ External Voice Mail or InMail)	1		✓	
22-07-01	<b>DIL Assignment</b> If routing unanswered Private Lines to voice mail, assign DILs to the extensions. ➡ For this selection to work, set Program 22-02-01 to 4 (DIL).	Day/Night Modes (1 ~ 8): Extension Number (maximum of eight digits) Pilot Number	No Setting	✓		

## Operation

### To place a call on your Private Line:

1. Press **Private Line** key and then press **Speaker** or lift the handset.
2. Dial the number.

### To answer a call on your Private Line:

1. Press **Private Line** key, and then press **Speaker** or lift handset.

**To place a call from your multiline terminal on you Private Line:**

1. Press the **Private Line** key, then press **Speaker** or lift the handset.
2. Dial the number.

**To answer a call from your multiline terminal on your Private Line:**

1. Press **Private Line** key or press **Speaker** or lift handset.

**To place a call on your Private line from a single line telephone:**

1. Pick up handset.
  - ◇ *Private Line dial tone is heard.*
2. Dial the number.

**To answer a call on you Private Line from a single line telephone:**

1. Lift the handset.

## Programmable Function Keys

### Description

Each multiline terminal has Programmable Function Keys. Programmable Function Keys simplify placing calls, answering calls and using certain features. You can customize the function of a multiline terminal programmable keys from each multiline terminal. Depending on your telephone style, you can have up to 48 Programmable Function keys.

### Conditions

- When a key is programmed using service code 752, that key cannot be programmed with a function using the 751 code until the key is undefined (000). For example with a Park Key programmed by dialing 752 + \*04 must be undefined by dialing 000 before it can be programmed as a Voice Over key by dialing 751 + 48.
- Using Program 92-01 to copy a multiline terminal Programmable Function Keys, copies all the keys whether or not they exist on the telephone to which the programming is being copied. This may cause confusion when trying to define a key which is already defined but which does not exist on the telephone (displays as DUPLICATE DATA). It is recommend to either clear these non-existent keys or to copy only from an extension which has the same or fewer number of keys than the extension to which the programming is being copied.
- Speed Dialing and One-Touch Calling also offer quick access to calls and features.
- Programming a 60-button console requires separate programming.
- If the feature key is not listed below, the LCD shows ALL-BLANK. (Program 15-07-01 Line Key Assign).

Function Number	Function	Display
00	None	[All Blank]
01	DSS/One-Touch	DSS (xxxxxxxx xxxxxxxx = Extension Number)
02	Microphone Key (ON/OFF)	MIC
03	DND Key	DND
04	BGM (ON/OFF)	BGM
05	Headset	HSET
07	Conference Key	CONF
10	Call Forward – Immediate	CFA
11	Call Forward – Busy	CFB
12	Call Forward – No Answer	CFNA
13	Call Forward – Busy/No Answer	CFBNA
14	Call Forward – Both Ring	CFBOTH
15	Follow Me	FLWME

Function Number	Function	Display
➤	<i>If a key is programmed as a DSS/One-Touch key for a station that is set for Call Forward All Calls or Do Not Disturb, the DSS/One-Touch key flashes.</i>	
➤	<i>Refer to the UNIVERGE SV9100 Programming Manual for a complete list of Function Numbers.</i>	
○	One-Touch keys programmed for Park Hold Service Code cannot be used to park calls without using Hold or Transfer.	
○	Pauses can be entered in the dial string of a DSS/One Touch button. The pause is entered as P in the dial string and causes the system to wait three seconds before sending the rest of the digits that follow the P (pause). Multiple pauses can be entered.	
○	The @ can be entered in the dial string of a DSS/One Touch button. The @ only applies to ISDN and Intercom calls. When using the @, the system waits for the destination to answer (answer supervision), and then sends the rest of the digits.	
○	Entering a P (pause) in a DSS/One Touch dial string can be used for CO calls, Intercom calls, or after the @ for ISDN calls.	
○	DSS/One-Touch keys can be used for one-touch transfer.	
○	DSS keys can distinguish whether the telephone is set for DND/Call Forward All Calls or if the telephone is off-hook.	
○	When a Ring Group call rings a station, a BLF Indication for this station shows idle or busy based on Class of Service option (20-13-49).	
○	All features programmed under one touch keys are still subject to class of service restrictions.	
○	If you change the extension assigned to a port in Program 11-02, the line key programming does not follow. However, if you move the extension using the Station Relocation Feature, the line key programming does follow.	
○	In order for a station to retrieve a held ICM call, the station must have an ICM key assigned in 15-07 (*00).	

## Default Settings

The first eight keys on a telephone are line keys (e.g., key 1 = line 001). The remaining keys are unassigned.

## System Availability

### Terminals

All Multiline Terminals

### Required Component(s)

None

### Related Features

- ↳ [Direct Station Selection \(DSS\) Console](#)
- ↳ [One-Touch Calling](#)
- ↳ [Speed Dial – System/Group/Station](#)

### Guide to Feature Programming

The **Level 1**, **Level 2** and **Level 3** columns indicate the programs that are assigned when programming this feature in the order they are most commonly used. These levels are used with PCPro and WebPro wizards for feature programming.

- Level 1 – these are the most commonly assigned programs for this feature.
- Level 2 – these are the next most commonly assigned programs for this feature.
- Level 3 – these programs are not often assigned and require an expert level working knowledge of the system to be properly assigned.

Program Number	Program Name/Description	Input Data	Default	Level		
				1	2	3
15-07-01	<b>Programmable Function Keys</b> Assign the functions of a multiline terminal Programmable Function Keys.	Line Key 1 ~ 48 0 ~ 99 (Normal Function Code 751 by default) *00 ~ *99 (Appearance Function Code) (Service Code 752 by default)	Refer to the Programming Manual for default values.	✓		
15-20-01	<b>LCD Line Key Name Assignment</b> Define the Line Key Name for line keys on DESILESS terminals.	Maximum of eight digits. Maximum of 13 characters. Key Number: 01 ~ 16 (for 16LD TEL) 17 ~ 32 (for 16LD ADM)	LK01 CO001 : : LK08 CO008 LK09 All Blank : : LK48 All Blank		✓	
20-06-01	<b>Class of Service for Extensions</b> Assign Class of Service (1 ~ 15) to extensions.	Day Night/Mode: 1 ~ 8 Class of Service of Extensions (1 ~ 15)	Extension port 101 = Class 15 All other extension port = Class 1	✓		

Program Number	Program Name/Description	Input Data	Default	Level		
				1	2	3
20-07-10	<p><b>Class of Service Options (Administrator Level) – Programmable Function Key Programming (Appearance Level)</b></p> <p>Turn Off or On an extension user ability to program the Appearance function keys using Service Code 752.</p> <p>➡ <i>When programming a feature as a Programmable Function Key, refer to Program 15-07-01 in the UNIVERGE SV9100 Programming Manual.</i></p>	<p>0 = Off 1 = On</p>	COS 1 ~ 15 = 1	✓		
20-13-18	<p><b>Class of Service for Options (Supplementary Service) – Programmable Function Key Programming (General Level)</b></p> <p>Turn Off or On an extension user ability to program General function keys using Service Code 751 (by default). (Refer to Program 20-07-10 for Service Code 752.)</p>	<p>0 = Off 1 = On</p>	COS 1 ~ 15 = 1	✓		
20-13-49	<p><b>Class of Service for Options (Supplementary Service) – BLF Indication on CO Incoming State</b></p> <p>Turn Off or On the BLF Indication on CO Incoming State.</p>	<p>0 = Off 1 = On</p>	COS 1 ~ 15 = 0		✓	

## Operation

### To change a 2-digit programmable key:

1. Press **Speaker**.
2. Dial **751** for 2-digit codes.
3. Press the key you want to program.
4. Enter the 2-digit key function, any additional information needed for the key and press **Hold**.
  - ◇ *For available functions codes refer to Program 15-07 in the UNIVERGE SV9100 Programing Manual.*
  - ◇ *To undefine a key, enter 00.*

### To change a 3-digit programmable key:

1. Press **Speaker**.
2. Dial **752** for 3-digit codes.
3. Press the key you want to program.
4. Enter the 3-digit key function and any additional information needed for the key.
  - ◇ *For available functions codes, refer to Program 15-07 in the UNIVERGE SV9100 Programming Manual.*

- ◇ *To undefine a key, enter 000.*
- ◇ *When a key is programmed using service code 752, that key cannot be programmed with a function using the 751 code until the key is undefined (000). For example with a Park Key programmed by dialing 752 + \*04 must be undefined by dialing 000 before it can be programmed as a Voice Over key by dialing 751 + 48.*

#### **To check the function of a programmable key:**

1. Press the **Help** key.
2. Press the programmable key.
  - ◇ *The programmed function displays.*

## Programming from a Multiline Terminal

### Description

System Programming can be performed from any display multiline terminal. Most programming changes become effective immediately. Other programming changes become effective after the data is backed up from temporary memory to permanent memory.

### Conditions

- Up to two telephones can be in programming mode anytime.
- A maximum of four users can be logged into WebPro anytime.
- Two WebPro users and two phone programming users can be logged in at the same time for a **total of four users** in programming mode simultaneously. However, the two phone programming users do not show up in session management in WebPro.
- PCPro can be logged in with only one user. This is allowed only if no other users are logged into programming mode (PCPro, WebPro, or Phone). Also, if a user is connected to the switch via PCPro, no other user can log in through PCPro, WebPro, or Phone Programming.
- Programming from a multiline terminal can require a password to enter programming.
- Temporary License can be activated only from a multiline terminal, not PCPro or WebPro.
  - ❑ When activated, the system is temporarily licensed for all licenses except Encryption (feature code 0030).
  - ❑ Each time the temporary license is activated, the program is read only until the temporary license expires.
  - ❑ Each time the temporary license expires, it can be set again for up to 10 additional days.
  - ❑ After setting a number of days in the program, subsequent days show one less as it counts down to expiration.
  - ❑ When Program 90-37-01 shows 1, the license expires at midnight on that day. When the license expires, the system resets.
  - ❑ If the date is changed in Program 10-01-01 while the temporary license is in effect, one day is subtracted from the license period.
  - ❑ If the date is changed in Program 10-01-01 when the temporary license shows 1 day, the system resets when it is applied (Transfer), not when exiting programming mode.

### Default Settings

Enabled



## System Availability

### Terminals

All Multiline Terminals with Display

### Required Component(s)

Any DLC Blade

### Required Software

None

## Related Features

↳ [PC Programming](#)

## Guide to Feature Programming

The **Level 1**, **Level 2** and **Level 3** columns indicate the programs that are assigned when programming this feature in the order they are most commonly used. These levels are used with PCPro and WebPro wizards for feature programming.

- Level 1 – these are the most commonly assigned programs for this feature.
- Level 2 – these are the next most commonly assigned programs for this feature.
- Level 3 – these programs are not often assigned and require an expert level working knowledge of the system to be properly assigned.

Program Number	Program Name/Description	Input Data	Default	Level		
				1	2	3
90-02-01	<b>Programming Password Setup – User Name</b> Set the system passwords.	Maximum of 10 characters.	Refer to the Programming Manual for default values.		✓	
90-02-02	<b>Programming Password Setup – Password</b> Configure the administrator accounts that are used when connecting to the KTS via PCPro/ WebPro. If using PCPro, these are the accounts that are used to <i>connect</i> . If using WebPro, these are the accounts that are used to login.	Maximum of eight digits.	Refer to the Programming Manual for default values.		✓	

Program Number	Program Name/Description	Input Data	Default	Level		
				1	2	3
90-02-03	<b>Programming Password Setup – User Level</b> Set the system password user levels.	0 = Prohibited User 1 = MF (Manufacturer Level) 2 = IN (Installer Level) 3 = SA (System Administrator Level 1) 4 = SB (System Administrator Level 2) 5 = UA (User Programming Level 1)	Refer to the Programming Manual for default values.		✓	

## Operation



*Refer to the UNIVERGE SV9100 Programming Manual for additional information.*

REFERENCE

## Pulse to Tone Conversion

### Description

An extension can use Pulse to Tone Conversion on trunk calls. Pulse to Tone Conversion lets a user change their extension dialing mode while placing a call. For systems in a Dial Pulse area, this permits users to access dial-up OCCs (Other Common Carriers – such as MCI) from their DP area. The user can, for example:

- Place a call to an OCC over a DP trunk.
- Depending on programming:  
Manually implement Pulse to Tone Conversion  
- OR -  
Wait 10 seconds.
- Dial the OCC security code and desired number. The system dials the digits after the conversion as DTMF.

### Conditions

Pulse to Tone Conversion is valid only for Dial Pulse trunks (Program 14-02-01, options 0 or 1).

### Default Settings

Enabled

### System Availability

#### Terminals

All Multiline Terminals

#### Required Component(s)

GCD-4COTB, GPZ-4COTF

- OR -

GCD-4ODTA

- OR -

GCD-CCTA

## Related Features

- ➔ [Central Office Calls, Placing](#)
- ➔ [Multiple Trunk Types](#)

## Guide to Feature Programming

The **Level 1**, **Level 2** and **Level 3** columns indicate the programs that are assigned when programming this feature in the order they are most commonly used. These levels are used with PCPro and WebPro wizards for feature programming.

- Level 1 – these are the most commonly assigned programs for this feature.
- Level 2 – these are the next most commonly assigned programs for this feature.
- Level 3 – these programs are not often assigned and require an expert level working knowledge of the system to be properly assigned.

Program Number	Program Name/Description	Input Data	Default	Level		
				1	2	3
14-02-01	<b>Analog Trunk Data setup – Signaling Type (DP/DTMF)</b> At default, Program 14-02-01 is set to 2.	0 = Dial Pulse (10 PPS) 1 = Dial Pulse (20 PPS) 2 = DTMF	2	✓		
14-02-07	<b>Analog Trunk Data Setup – DP to DTMF Conversion Options</b> For each trunk, set the type of DP to DTMF Conversion required.	0 = Automatic 1 = Automatic and Manual 2 = Manual	2	✓		

## Operation

### To convert your telephone dialing to tone after placing your call on a pulse line:

1. Place a call over pulse line.
2. Dial # to switch the DP trunk to DTMF dialing.

### Description

Users can press Redial to cycle through the last 10 outside numbers dialed. Pressing # redials the number displayed. Users can also press Redial and dial a System Speed Dial bin number to access System Speed Dial.

### Outgoing Call History

Outgoing Call History can save the last 10 numbers dialed.

### Cursor Key Operation

By pressing the Left Cursor Key, the user can access the Redial and incoming Call History menus. The flow chart below shows the menu access sequence. If the terminal is not allowed to have the Dial Preview feature, these menus cannot be accessed.

Figure 2-75 Left Cursor Key Operation Flow Chart

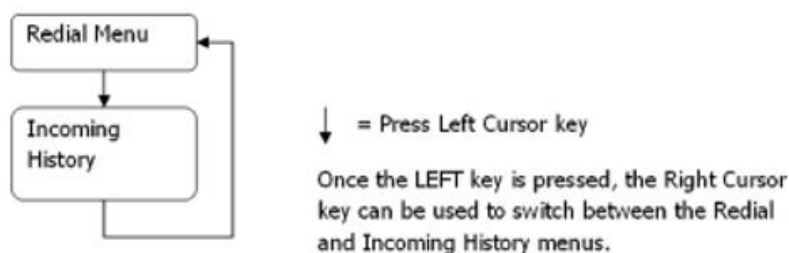

### Conditions

- Redial list contains time and date information.
- Name Stored in Speed dial, Telephone book or extension name for the dialed number will be displayed.
- One entry will be saved for the same number when Program 15-02-73 is set to Pack.
- When Program 15-02-73 is set to Unpack, one entry will be saved for the same number using a different trunk group if calling time is same.
- The Date display area in outgoing call history starts at four digit spaces from the left.
- Redial List requires a display telephone.
- This feature is not supported on multiline cordless phones.

- UNIVERGE SV9100 telephones only support redial using Softkey or Navigation key.
- Stored name for Redial Function is cleared when the system is reset.
- With SV9100 software, names and numbers stored as a common or group speed dial can be displayed for redialed numbers.

## Default Settings

Enabled

## System Availability

### Terminals

All Multiline Terminals

### Required Component(s)

None

## Related Features

- ➔ **Last Number Redial**
- ➔ **Speed Dial – System/Group/Station**

## Guide to Feature Programming

The **Level 1**, **Level 2** and **Level 3** columns indicate the programs that are assigned when programming this feature in the order they are most commonly used. These levels are used with PCPro and WebPro wizards for feature programming.

- Level 1 – these are the most commonly assigned programs for this feature.
- Level 2 – these are the next most commonly assigned programs for this feature.
- Level 3 – these programs are not often assigned and require an expert level working knowledge of the system to be properly assigned.

Program Number	Program Name/Description	Input Data	Default	Level		
				1	2	3
15-02-13	<b>Multiline Telephone Basic Setup – Outgoing Caller List Mode</b> The outgoing Call history stores both Internal and Trunk calls (0) or Trunk calls (1).	0 = Extension/Trunk Mode 1 = Trunk Mode	1	✓		
15-02-73	<b>Multiline Telephone Basic Setup – Calling Party History View Mode</b> For saving multiple entry for the same number (in case of different calling time) set this data to 1. For saving single entry for the same number set this data to 0.	0 = Pack 1 = Unpack	0	✓		
80-05-01	<b>Date Format for SMDR and System – Date Format</b> Set the date format for SMDR	0 = American Format (Month / Day / Year) 1 = Japanese Format (Year / Month / Day) 2 = European Format (Day / Month / Year)	0		✓	

## Operation

### To redial the last number dialed:

1. Press **Redial/Left Navigation Key**.
  - When using 24 digit LCD Terminal REDIAL [#] / ABB is displayed along with date and time of the last dialed number.
  - When using 28 digit LCD Terminal REDIAL [#] / ABB is displayed along with date, time and name of the last dialed number. If no name is set only Date and time is displayed.
2. Press the **up** or **down** arrow to view the number to dial.
3. Press # or press **Speaker** or lift the handset or press an idle trunk key.
 

- OR -

  1. Press the **List** softkey
  2. Press **Redial**.
    - When using 24 digit LCD Terminal **01**: is displayed along with the name of the last dialed number.
    - When using 28 digit LCD Terminal **01**: is displayed along with the last dialed data (name and number) .If no name is set only number is displayed.
  3. Press the up and down arrow to view the number to dial.

4. Press the **#** key or press **Speaker** or lift the handset or press and idle trunk key.

#### To scroll through the last 10 outside numbers dialed:

1. Press **Redial**. Each time the Redial key is pressed, it displays the next most recently dialed number.
2. When the desired number is displayed, press the **#** key or press **Speaker** or lift the handset.  
- OR -
  1. Press the **List** softkey
  2. Press **Redial**.
  3. Press the up and down arrow to view the number to dial.
  4. Press **#** or press **Speaker** or lift the handset.

#### To access a System Speed Dial bin:

1. Press **Redial/Left Navigation Key**.
  - When using 24 digit LCD Terminal REDIAL [#] / ABB is displayed along with date and time of the last dialed number.
  - When using 28 digit LCD Terminal REDIAL [#] / ABB is displayed along with date, time and name of the last dialed number. If no name is set only Date and time is displayed.
2. Dial the System Speed Dial bin number.  
The number stored in that bin is displayed for your preview.
3. Press **#** or press **Speaker** or lift the handset or press and idle trunk key.

#### To view saved name history of outgoing calls:

1. Press **Redial/Left Navigation Key**.
  - When using 24 digit LCD Terminal REDIAL [#] / ABB is displayed along with date and time of the last dialed number.
  - When using 28 digit LCD Terminal REDIAL [#] / ABB is displayed along with date, time and name of the last dialed number. If no name is set only Date and time is displayed.
2. Tap the cursor key up or down to refresh the list, if the redialed number has a matching either Speed Dial, Center Telephone Book or extension name associated with it, the name information from Program 13-04-02, 13-07-03 or 15-01-01 is displayed.
3. Press **Speaker** or lift the handset to dial the number.
  - ◇ *The name information will not display after dialing.*



### 24 Digit LCD

1. Press **Redial**.

REDIAL[#] / ABB is displayed along with date and time of the last dialed number.



2. Press the up and down arrow to view the dialed data.

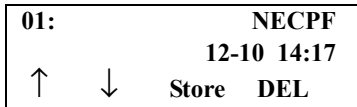

- ◇ A maximum of 12 characters (Name) is displayed on the first line of the LCD.
- ◇ A maximum of 11 digits (Date - MM-DD HH:MM) is displayed on the second line of the LCD.

3. Name and number can be toggle by pressing **Help** key.

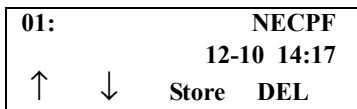

The name is changed to a Number.

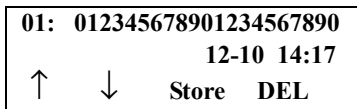

- ◇ A maximum of 21 digits (dialed number with right shift) is displayed on the first line of the LCD.

4. If the name is not set, a maximum of 21 digits (dialed number with right shift) is displayed on the first line of the LCD.

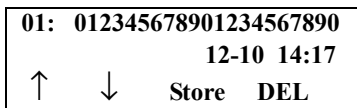

- ◇ If the number exceeds 21 digits, only the first 21 digits are displayed on the first line of the LCD.

### 28 Digit LCD

1. Press **Redial**.

REDIAL[#] / ABB is displayed along with date and time of the last dialed number.

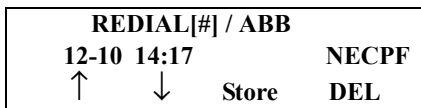

2. Press the up and down arrow to view the dialed data.

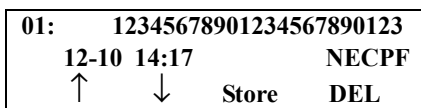

- ◇ A maximum of 24 digits (with right shift) is displayed on the first line of the LCD.

- ◇ A maximum of 11 digits (Date - MM-DD HH:MM) is displayed on the second line of the LCD.
  - ◇ A maximum of 12 characters (Name) is displayed on the second line of the LCD.
3. If the name is not set, a maximum of 24 digits (dialed number with right shift) is displayed on the first line of the LCD.

<b>01:</b>	<b>12345678901234567890123</b>
	<b>12-10 14:17</b>
↑	↓ <b>Store    DEL</b>

## Remote (System) Upgrade

### Description

With PCPro or WebPro, the UNIVERGE SV9100 can be remotely upgraded to a newer version of main system software. When a new version of main system software is released, a firmware package file is provided. Using the PCPro or WebPro application, a technician can remotely upgrade the firmware on the GCD-CP10. The upgrade can be applied immediately, or at a scheduled date and time. Remote Upgrade is supported only via a LAN connection. A modem connection is NOT supported for Remote Upgrade.

### Conditions

- When doing a Firmware Upgrade, the telephone system can become sluggish during the file transfer portion of the update. You should perform updates after hours, even if the update is scheduled. The file transfer happens when the update is set. For example, at 2:00PM a technician schedules an update to happen at 12:00AM. When they click start (2:00PM), it begins transferring the file to the system. At this time the telephone system experiences sluggishness until the file transfer is complete. When the time turns to 12:00AM, the telephone system resets and switches to the new firmware.
- The Package file needed is provided by NEC at the time the new version of main system software is released.
- Booting from the USB drive does not replace the firmware in Flash Memory on the GCD-CP10.
- The time entered on the Firmware Upgrade screens is relative to the time on the GCD-CP10, not the PC that PCPro was launched from. The user should take into account time zone differences when using this feature.
- The time to upload a firmware package file is directly related to the file size. Generally, it takes a few minutes.
- Remote Upgrade is supported only via LAN connection. A modem or serial connection is not supported for Remote Upgrade.
- Web Pro supports remote upgrade and is only available in the Manufacture (MF) and Installer (IN) level logins.
- If a loss of connection occurs during a Remote Upgrade, the Remote Upgrade fails and the Remote Update process stops. The system remains at the previously installed software.

### Default Settings

At default, PCPro and WebPro are set to *Update Immediately* after the upload.

## System Availability

### Terminals

None

### Required Component(s)

PCPro

PC connection with WebPro

## Related Features

### ↳ **PC Programming**

## Guide to Feature Programming

Refer to [PC Programming](#) on page 2-1286.

## Operation

### PCPro:

1. Obtain the firmware package file from NEC.
2. Open and login to PCPro.
3. Connect to the system.
4. Under the Home menu, choose the **Upgrade SW** option.
  - ◇ *Until connected to the system the Firmware Update option is grayed out.*
5. In the **Firmware Update** window, browse to the location of the Firmware Package file. Only the .mdu file will be applicable here. For example, the file name might be 'SV9100\_v1.xx.xx'.
6. Select the schedule type:
  - Immediately after upload
  - At the time...
    - ◇ *If you choose At the time..., select the date and time you want the GCD-CP10 to reset and switch over to the new software version.*

7. Click **Start**. PCPro uploads the firmware package file, and updates the system at the time you specified in step 6.



*For additional information, refer to the UNIVERGE SV9100 PC Programming Manual.*

### WebPro

1. Obtain the firmware package file from NEC.
2. Open and login to WebPro.
3. On the Home Page, choose **Firmware Update**.
4. In the **Firmware Update** page, browse to the location of the Firmware Package file. For example, the file name might be 'SV9100\_v1.00RemoteUpgrade.mem'.
5. Select the schedule type:
  - Immediately after upload
  - At the time...



*If you choose At the time..., select the date and time you want the GCD-CP10 to reset and switch over to the new software version.*

6. Click **Start Update**. WebPro uploads the firmware package file, and updates the system at the time you specified in step 6.



*For additional information, refer to the UNIVERGE SV9100 PC Programming Manual.*

## Repeat Redial

### Description

If a multiline terminal user places a trunk call that is busy or unanswered, they can have Repeat Redial try it again later on. The user does not continually have to try the number again – hoping it goes through. Repeat Redial automatically retries it until the called party answers (the number of retries is based on system programming).

### Conditions

- Lifting the handset during a callout cycle cancels Repeat Redial.
- Other programmed options for outgoing calls can affect how a Repeat Redial call is placed. Refer to Central Office Calls, Placing options as needed.
- For systems with Automatic Route Selection (ARS), ARS selects the trunk for the Repeat Redial call.
- Single line telephones cannot use Repeat Redial.

### Default Settings

Enabled

### System Availability

#### Terminals

All Multiline Terminals

#### Required Component(s)

None

### Related Features

- ➔ **Automatic Route Selection (ARS)**
- ➔ **Central Office Calls, Placing**
- ➔ **Last Number Redial**
- ➔ **Save Number Dialed**

↳ **Single Line Telephones, Analog 500/2500 Sets**

## Guide to Feature Programming

The **Level 1**, **Level 2** and **Level 3** columns indicate the programs that are assigned when programming this feature in the order they are most commonly used. These levels are used with PCPro and WebPro wizards for feature programming.

- Level 1 – these are the most commonly assigned programs for this feature.
- Level 2 – these are the next most commonly assigned programs for this feature.
- Level 3 – these programs are not often assigned and require an expert level working knowledge of the system to be properly assigned.

Program Number	Program Name/Description	Input Data	Default	Level		
				1	2	3
<b>15-07-01</b>	<b>Programmable Function Keys</b> Assign a function key for Repeat Redial (code 29).	Line Key 1 ~ 48 0 ~ 99 (Normal Function Code 751 by default) *00 ~ *99 (Appearance Function Code) (Service Code 752 by default)	Refer to the Programming Manual for default values.	✓		
<b>20-06-01</b>	<b>Class of Service for Extensions</b> Assign a Class of Service (1 ~ 15) to an extension.	Day Night/Mode: 1 ~ 8 Class of Service of Extensions (1 ~ 15)	Extension port 101 = Class 15 All other extension port = Class 1	✓		
<b>20-08-07</b>	<b>Class of Service Options (Outgoing Call Service) – Repeat Redial</b> Turn Off or On an extension to use Repeat Redial.	0 = Off 1 = On	COS 1 ~ 15 = 1	✓		
<b>21-08-01</b>	<b>Repeat Dial Setup – Repeat Redial Count</b> Set how many times Repeat Redial automatically repeats if the call does not go through.	0 ~ 255	0 ~ 255 (default = 3)	✓		
<b>21-08-02</b>	<b>Repeat Dial Setup – Repeat Redial Interval Time</b> Set the time between Repeat Redial attempts.	0 ~ 64800 seconds	60	✓		
<b>21-08-03</b>	<b>Repeat Dial Setup – Repeat Dial Calling Timer</b> Set the time the system waits for the called party to answer after a Repeat Redial. If the called party does not answer in this time, the system hangs up and tries again (after the Repeat Redial Interval Time). For unanswered calls, the total time between retries is the sum of Program 21-08-02 and Program 21-08-03.	0 ~ 64800 seconds	30	✓		

Program Number	Program Name/Description	Input Data	Default	Level		
				1	2	3
21-08-04	<b>Repeat Dial Setup – Time for Send Busy Tone for ISDN Trunk</b> Set the time to send out Busy Tone with an ISDN line, when called party is busy.	0 ~ 64800 seconds	0	✓		

## Operation

### To use Repeat Redial (if the outside party you call is unavailable or busy):

1. Place a trunk call.
  - ◇ Listen for busy tone or ring no answer.
2. Press **Feature + Redial**.
  - OR -
  - Press the **Repeat Redial** key (Program 15-07 or SC 751: 29).
    - ◇ Repeat Redial key flashes while you wait for the system to redial.
3. Press **Speaker** to hang up.
  - ◇ The system periodically redials the call.
4. Lift the handset when called party answers.
  - ◇ When using trunks with answer supervision the Repeat Redial feature automatically cancels.

### To cancel Repeat Redial:

1. Press **Feature**.
2. Press **Redial**.
  - OR -
  - 1. Press **Repeat Redial** key (Program 15-07 or SC 751: 29).  
(Also refer to [Last Number Redial on page 2-1059](#).)



## Resident System Program

### Description

When power is supplied to the system, the hardware configuration is scanned and Resident System Program default values are assigned including terminal types (e.g. PGD(2)-U10 ADP, DSS Console). This enables immediate operation, even before the system is programmed to accommodate the individual site requirements.

### Conditions

- Default assignments for multiline terminals are: LK 01~LK 08 corresponds to CO 01~CO 08.
- DSS Console to Extension assignments for Attendant Add-On Consoles are not assigned.
- Default Attendant Add-On Console key assignments are:  
DSS Keys = 001~060  
Stations = 101~160
- First Initialization of the system returns all programming values to default. Without a PC-ATA USB Drive installed, press and hold the SW1 (Load Switch) and toggle the Reset (SW2) switch. Continue to hold the SW1 switch for approximately 5~10 seconds before releasing. The system boots loading Resident System Programming.

### Default Settings

None

### System Availability

#### Terminals

None

#### Required Component(s)

None

### Related Features

None

## Guide to Feature Programming

None

## Operation

None

## Reverse Voice Over

### Description

During a call, Reverse Voice Over lets a busy multiline terminal user make a private Intercom call to an idle co-worker. The idle co-worker can be at a multiline terminal or single line telephone. The busy user just presses a programmed Reverse Voice Over key to make a private call to a specified co-worker. The initial caller cannot hear the Reverse Voice Over conversation. The private Intercom call continues until the Reverse Voice Over caller presses the key again. The initial call can be an outside call or an Intercom call.

Reverse Voice Over could help a salesman, for example, when placing a call to an important client. The salesman can talk with the client and give special instructions to a secretary – without interrupting the initial call.

When the multiline terminal is idle, the Reverse Voice Over key functions the same as a Hotline or One-Touch key. A multiline terminal Reverse Voice Over key also shows at a glance the status of the associated extension:

When the key is . . .	The associated extension is . . .
Off	Idle
On	Busy or call ringing
Fast Flash	In Do Not Disturb



NOTE

*When the destination extension is idle, the Reverse Voice Over provides one button calling to the associated extension (like a Hotline key). An extension user cannot, however, use the Reverse Voice Over key to Transfer calls by one-touch operation.*

### Conditions

- An extension can have Reverse Voice Over keys for more than one extension (limited only by the number of available function keys).
- When the destination extension is in Do Not Disturb, a Reverse Voice Over placed to an extension always rings, regardless of how Handsfree Answerback/Forced Intercom Ringing is set at the destination.
- When the destination extension is not in Do Not Disturb, Reverse Voice Over follows Handsfree Answerback/Forced Intercom Ringing programming.
- Reverse Voice Over is not available from single line telephones, but a single line can be a Reverse Voice Over destination.
- Reverse Voice Over requires a uniquely programmed function key.

- If an extension user places a Reverse Voice Over to a busy destination extension, the system sets up a Voice Over. The Voice Over continues until the Reverse Voice Over key is pressed again.
- When a Reverse Voice Over call is placed to a destination station, while the originator is on a CO call, the Reverse Voice Over is dropped if the destination station is involved in another call and this call is terminated.

### Default Settings

Disabled

## System Availability

### Terminals

All Multiline Terminals

### Required Component(s)

None

## Related Features

- **Do Not Disturb**
- **Handsfree Answerback/Forced Intercom Ringing**
- **Hotline**
- **One-Touch Calling**
- **Programmable Function Keys**
- **Single Line Telephones, Analog 500/2500 Sets**
- **Voice Over**

## Guide to Feature Programming

The **Level 1**, **Level 2** and **Level 3** columns indicate the programs that are assigned when programming this feature in the order they are most commonly used. These levels are used with PCPro and WebPro wizards for feature programming.

- Level 1 – these are the most commonly assigned programs for this feature.
- Level 2 – these are the next most commonly assigned programs for this feature.
- Level 3 – these programs are not often assigned and require an expert level working knowledge of the system to be properly assigned.

Program Number	Program Name/Description	Input Data	Default	Level		
				1	2	3
<b>15-07-01</b>	<b>Programmable Function Keys</b> Assign a function key for Reverse Voice Over (code 47 + destination extension). Assign a function key for Voice Over to the destination extension (code 48). This allows the user at the destination to switch between calls if they were busy when the Reverse Voice Over was initiated.	Line Key 1 ~ 48 0 ~ 99 (Normal Function Code 751 by default) *00 ~ *99 (Appearance Function Code) (Service Code 752 by default)	Refer to the Programming Manual for default values.	✓		
<b>20-06-01</b>	<b>Class of Service for Extensions</b> Assign a Class of Service (COS) to each extension (1 ~ 15).	Day Night/Mode: 1 ~ 8 Class of Service of Extensions (1 ~ 15)	Extension port 101 = Class 15 All other extension port = Class 1		✓	
<b>20-13-06</b>	<b>Class of Service Options (Supplementary Service) – Automatic Off-Hook Signaling (Automatic Override)</b> Allow a busy extension to Manually (0) or Automatically (1) receive off-hook signals. ➡ <i>This setting is to receive incoming call signaling information during call queuing.</i>	0 = Off 1 = On	COS 1 ~ 15 = 1		✓	

## Operation

### When on a call:

#### To place a Reverse Voice Over call:

1. Press your **Reverse Voice Over** key (Program 15-07 or SC 751: 47 + destination extension).
  - ◇ *Your Reverse Voice Over key lights steadily (red) and you can talk with the programmed Reverse Voice Over destination.*

### When the telephone is idle:

#### To place a call to your Reverse Voice Over destination:

1. Press your **Reverse Voice Over** key (Program 15-07 or SC 751: 47 + destination extension).
  - ◇ *You can optionally lift the handset after this step for privacy.*

## RGA Conference

### Description

The SV9100 supports the GCD-RGA blade.

The maximum Port Capacity Supported is 32 Ports on one blade and integrates to the SV9100 system using the backplane. A total of 32 simultaneous people can be in one Audio Conference or in multiple Audio Conferences at the same time (sum total cannot exceed 32).

The extensive RGA feature set is conveniently managed through the built-in Web-Based Administration tool. This tool emphasizes sophistication in a simple-to-understand format that features integrated help for each topic.



*Do not plug the RGA LAN into a customer's existing network without first verifying the RGA's DHCP server will not cause a conflict. If needed, connect the support PC directly to the RGA to make configuration changes before connecting the existing network.*

### General

The RGA Conference application provides the following features:

- A maximum of 32 Audio Conference ports.
- Reservation-less and Reservation based audio conferences.
- Basic Conference features:
  - Select entry and exit tones.
  - Select memorable vanity PINs.
  - Select name announcement on/off.
  - Select enter audio conference muted on/off etc.
  - Schedule recurring audio conferences via the Web Portal.
  - Use Microsoft Outlook® iCalendar application to send invitations to desired participants.
  - Conduct audio conference with or without Moderator presence required.
  - See real time view of a running audio conference via Web Portal. Participants can be viewed by name or by Caller ID.
  - Display loudest speaker – helps identify and mute participants that may be inadvertently injecting noise or echo into the audio conference.
  - Exercise multiple in-conference controls via phone key presses or the Web Portal.
  - On-the-fly dial out and add participants to a running conference.
  - Transfer participants between conferences via the Web Portal.
  - Raise Hand to get Moderator's attention.
  - Send a detailed end of conference summary report to the Moderator after a given conference ends.

- Enhancement I License features:
  - Turn recording on/off.
  - Conference recording capacity: 1000 minutes
  - Record entire conference or excerpts from a conference.
  - Conference playback via Windows Media Player®.
  - Conference playback via IVR.
- Language License Features
  - Activates one additional language. Pre-installed language packages are English, Spanish, French and Portuguese (RGA Conference Application Version 7.1-0.11 or higher required). Default: (English is selected)

### Audio Conferencing Application

Audio Conferencing Application provides rich conferencing experience for demanding users.

### Conferencing Capacity

- Audio Conference Ports: 32
- Audio Recording storage capacity: 16 hours

### Conditions

- The RGA Conference Language license (6304) activates one additional language. Pre-installed language packages are English, Spanish, French and Portuguese (RGA Conference Application Version 7.1-0.11 or higher required). Default: (English is selected).
- The RGA Conference Language license (6304) requires firmware 4.00.78 or higher and RGA Conference Application 7.1-0.8 or higher.
- Caller ID information is not provided on calls transferred to the RGA Conference. Inbound trunk calls must be directed to the conference pilot for Caller ID to be provided.
- If a caller is prompted to record their name before conference entry but does not record a name and does not press #, the system will record for 50 seconds then add them to the conference. When the caller is added to the conference the recorded name of “50 seconds of silence” is played before they are provided a voice path.
- The RGA Enhancement I license (6301) supports the following:
  - Conference Recording capacity: 1000 minutes
  - Record entire conference or excerpts from a conference
  - Conference playback via Media Player
  - Conference playback via IVR
- If using a 9.5” Gateway (CHS2U GW-US) or Base (CHS2UG B-US) chassis the GCD-RGA and GCD-SVR2 cannot be installed in the same chassis.



- By default the RGA has the DHCP server enabled and will provide a device an IP Address within the range of 192.168.1.100 ~ 192.168.1.150.
- Do not plug the RGA LAN into a customer’s existing network without first verifying the RGA’s DHCP server will not cause a conflict. If needed connect the support PC directly to the RGA to make configuration changes before connecting the existing network.
- To connect to the RGA one of the following Web Browsers must be used:
  - ❑ Internet Explorer® version 9.0 or higher
  - ❑ Google Chrome™ version 27.0 or higher
  - ❑ Mozilla® Firefox® version 22.0 or higher
- By default the GCD-RGA WAN port will get the IP Address set in Program 10-55-01 for the slot in which the GCD-RGA was installed.
- If using the GCD-RGA for the RGA Conference application only the WAN port should be connected to the existing customer network and the LAN ports should not be used. If the Router functionality of the GCD-RGA will be used then the LAN ports can be used and connected to the existing customer network.
- Integration to the SV9100 requires a RGA Conference port license (6300) for each port.
- The RGA Conference cannot send a hook flash to Telco.

### Default Settings

DHCP Server enabled

IP Address 192.168.1.1

## System Availability

### Terminals

None

### Required Component(s)

- GCD-RGA Blade
- AKS RGA APP Gateway (Compact Flash Media)
- 0411 – SV9100 Version Lic (R1)
- 0300 – SV9100 Resource Lic
- 6300 – RGA Conf Port Lic
- 6301 – RGA Conf Enh I-Lic

## Related Features

- ➔ **Caller ID**
- ➔ **Call Appearance (CAP) Keys**
- ➔ **Class of Service**
- ➔ **Department Calling**
- ➔ **Intercom**
- ➔ **ISDN Compatibility**
- ➔ **Trunk Groups**
- ➔ **Trunk Group Routing**

## Guide to Feature Programming

The **Level 1**, **Level 2** and **Level 3** columns indicate the programs that are assigned when programming this feature in the order they are most commonly used. These levels are used with PCPro and WebPro wizards for feature programming.

- Level 1 – these are the most commonly assigned programs for this feature.
- Level 2 – these are the next most commonly assigned programs for this feature.
- Level 3 – these programs are not often assigned and require an expert level working knowledge of the system to be properly assigned.

Program Number	Program Name/Description	Input Data	Default	Level		
				1	2	3
<b>10-12-01</b>	<b>GCD-CP10 Network Setup – IP Address</b> Assign the IP Address.	0.0.0.0 ~ 126.255.255.254 128.0.0.1 ~ 191.255.255.254 192.0.0.1 ~ 223.255.255.254	192.168.0.10	✓		
<b>10-12-03</b>	<b>GCD-CP10 Network Setup – Default Gateway</b> Set the default gateway for system to IP Address provided by IT department.	0.0.0.0 ~ 126.255.255.254 128.0.0.1 ~ 191.255.255.254 192.0.0.1 ~ 223.255.255.254	0.0.0.0		✓	
<b>10-54-01</b>	<b>License Configuration for Each Package – License Code</b> Assign licenses to the Conference Application on a per slot basis. For the slot the GCD-RGA blade is installed in, assign the number of licensed conference bridge ports. The license feature code is 6300.  ➔ <i>License assignment in program 10-54-01 and 10-54-02 must be done before the system recognizes the GCD-RGA Blade.</i>	1 ~ 255 Resource Licenses	Refer to Program 10-50-01 in the Programming Manual.	✓		

Program Number	Program Name/Description	Input Data	Default	Level		
				1	2	3
10-54-02	<p><b>License Configuration for Each Package – License Quantity</b> Assign the number of licenses to the Conference Application per slot. For the slot the GCD-RGA blade is installed in, assign the number of licensed conference bridge ports.</p> <p>➡ <i>License assignment in program 10-54-01 and 10-54-02 must be done before the system recognizes the GCD-RGA Blade.</i></p>		Refer to Program 10-50-01 in the Programming Manual.	✓		
10-55-01	<p><b>Package Network Setup – IP Address</b> Define the IP Address for the GCD-RGA.</p> <p>➡ <i>When the blade is deleted from the system using Program 90-05, the programming for the slot in 10-55 is set back to default.</i></p>	0.0.0.0 ~ 126.255.255.254 128.0.0.1 ~ 191.255.255.254 192.0.0.1 ~ 223.255.255.254	172.16.1.100	✓		
10-55-04	<p><b>Package Network Setup – Sub Net Mask</b> Define the subnet mask for the GCD-RGA.</p>	128.0.0.0   192.0.0.0   224.0.0.0  240.0.0.0   248.0.0.0   252.0.0.0  254.0.0.0   255.0.0.0  255.128.0.0   255.192.0.0  255.224.0.0   255.240.0.0  255.248.0.0   255.252.0.0  255.254.0.0   255.255.0.0  255.255.128.0   255.255.192.0  255.255.224.0   255.255.240.0  255.255.248.0   255.255.252.0  255.255.254.0   255.255.255.0  255.255.255.128  255.255.255.192  255.255.255.224  255.255.255.240  255.255.255.248  255.255.255.252  255.255.255.254  255.255.255.255	255.255.0.0	✓		
10-55-05	<p><b>Package Network Setup – Default Gateway</b> Define the default gateway for the GCD-RGA.</p>	0.0.0.0 ~ 126.255.255.254 128.0.0.1 ~ 191.255.255.254 192.0.0.1 ~ 223.255.255.25	0.0.0.0	✓		
11-02-01	<p><b>Extension Numbering</b> Assign extension numbers to extension ports. The telephone programming identity follows the port number – not the extension number.</p>	Maximum of eight digits.	1 101 2 102 3 103 ~ ~ 99 199 100 3101 ~ ~ 960 3961	✓		
11-07-01	<p><b>Department Group Pilot Numbers – Dial</b> Assign a Department Group pilot number for the GCD-RGA (eight digits maximum). The extensions are assigned to the group in Program 16-02-01.</p>	Maximum of eight digits.	No Setting	✓		

Program Number	Program Name/Description	Input Data	Default	Level		
				1	2	3
14-02-23	<b>Analog Trunk Data Setup – Caller ID Receiving Method</b> Set to 0 (Wait for Caller ID) for all trunks.	0 = Wait Caller ID 1 = Immediate Ring	1		✓	
15-03-03	<b>Single Line Telephone Basic Data Setup – Terminal Type</b> Set to 1 (Special) for all GCD-RGA ports.	0 = Normal 1 = Special	0	✓		
15-07-01	<b>Programmable Function Keys</b> Program one Call Appearance Key (CAP Key) on RGA CNF port. Assign function keys as line (code *01 + trunk number) or Call Appearance (CAP) Keys [code *08 + CAP Key orbit 0001 ~ 9999 (or 0000 for auto assign)].	Trunks: 1 ~ 400 Line Key 1 ~ 48 0 ~ 99 (Normal Function Code 751 by default) *00 ~ *99 (Appearance Function Code) (Service Code 752 by default)	Refer to the Programming Manual for default values.	✓		
16-01-01	<b>Department Group Basic Data Setup – Department Name</b> Assign a name to the Extension (Department) Groups.	Maximum of 12 characters	No Setting		✓	
16-01-02	<b>Department Group Basic Data Setup – Department Calling Cycle</b> Set the call routing for Department Calling. Routing to priority (cycle to highest priority extension first).	0 = Normal Routing (Priority) 1 = Easy – UCD Routing (Circular)	0		✓	
16-01-03	<b>Department Group Basic Data Setup – Department Routing When Busy (Auto Step Call)</b> Set how the system routes an Intercom call to a busy Department Group member. Set to 1 (Routes to Idle Member).	0 = Normal (Intercom caller to busy department member hears busy) 1 = Circular (Intercom callers to busy department member routes to idle member)	0		✓	
16-01-04	<b>Department Group Basic Data Setup – Hunting Mode</b> Set the action taken when a call reaches the last extension in the Department Group. Set to 1 (Circular) so cycling repeats.	0 = Last extension is called and hunting is stopped 1 = Circular	0		✓	
16-02-01	<b>Department Group Assignment for Extensions</b> Set up the Department Group called by the pilot number and the extension priority when a group is called. Assign all GCD-RGA extensions to the group set in 11-07-01. Then set the priority for port 1 to 1, port 2 to 2 and so on until all ports have been assigned.	Department Groups 1 ~ 64 Priority 1 ~ 9999	Default = 1 extensions in Department Group 1 with priority in port order: Port 1 priority = 1 Port 256 priority = 256	✓		
20-13-13	<b>Class of Service Options (Supplementary Service) – Continued Dialing (DTMF) Signal on ICM Call</b> Turn Off or On an extension user ability to use Continued Dialing, which allows DTMF signal sending while talking on extension.	0 = Off 1 = On	COS 1 ~ 15 = 1		✓	

Program Number	Program Name/Description	Input Data	Default	Level		
				1	2	3
22-02-01	<p><b>Incoming Call Trunk Setup</b></p> <p>If in bound trunks are to be pointed at the GCD-RGA pilot number one of the following must be done.</p> <p>For Analog Trunks: Assign Service Type 4 to each trunk you want to ring into the GCD-RGA Conference Bridge as a Direct Inward Line (DIL). Then go to 22- 07-01.</p> <p>For PRI with DID: Assign service type 3 (DID) for each trunk. Then go to 22- 11-01.</p>	<p>Trunks 1 ~ 200</p> <p>0 = Normal</p> <p>1 = VRS (second dial tone if no VRS installed)</p> <p>2 = DISA</p> <p>3 = DID</p> <p>4 = DIL</p> <p>5 = E&amp;M Tie line</p> <p>6 = Delayed VRS</p> <p>7 = ANI/DNIS</p> <p>8 = DID(DDI) Mode Switching</p>	0		✓	
22-07-01	<p><b>DIL Assignment</b></p> <p>Assign the destination extension or Department Calling Group for each DIL incoming trunk. Assign the master/pilot number of the Conference group from Program 11-07-01 as the DIL destination.</p>	<p>Day/Night Modes (1 ~ 8):</p> <p>Extension Number (maximum of eight digits)</p>	No Setting		✓	
22-11-01	<p><b>DID Translation Number Conversion – Received Number</b></p> <p>For each DID Translation Table entry (1 ~ 4000), specify the digits received by the system.</p>	Maximum of eight digits.	No Setting	✓		
22-11-02	<p><b>DID Translation Number Conversion – Target Number</b></p> <p>For each DID Translation Table entry (1 ~ 4000), specify the extension the system dials after translation.</p> <p>Assign the master/pilot number of the Conference group from Program 11-07- 01 as the DID destination.</p>	Maximum of 24 digits.	No Setting	✓		

## Operation

Refer to the UNIVERGE SV9100 RGA Multimedia Conference Solution manual.

## Description

The SV9100 supports the GCD-RGA blade.

The NEC GCD-RGA Router Gateway blade is a plug-in blade for the UNIVERGE SV9100 Communications Server that offers a business-class routing/switching solution as well as application hosting. The GCD-RGA provides a WAN Router and 4-Port Gigabit Ethernet Switch in a single SV9100 blade. The RGA business-class features include multiple highly-configurable VPN connections, flexible QoS setup for each LAN port and a powerful Firewall.

The extensive RGA feature set is conveniently managed through the built-in Web-Based Administration tool. This tool emphasizes sophistication in a simple-to-understand format that features integrated help for each topic.



NOTE

*The RGA Router feature is not supported for the first release. This feature will be supported in a future build.*



CAUTION

*Do not plug the RGA LAN into a customer's existing network without first verifying the RGA's DHCP server will not cause a conflict. If needed, connect the support PC directly to the RGA to make configuration changes before connecting the existing network.*

## General

Each GCD-RGA blade comes with a built-in router application that provides the following features:

- DHCP Server
- WAN Router:
  - DHCP
  - PPPoE
  - Static IP
- Dynamic DNS
- Universal Plug and Play (UPnP)
- NAT capabilities including 1-to-1 NAT and/or Port Forwarding
- Virtual Private Network (VPN)
- Quality of Service (QOS):
  - Port
  - DSCP

- CoS (Class of Service)
- Traffic Shaping for Upstream and Downstream traffic
- Firewall:
  - Denial of Service (DoS) Protection
  - Black WAN ping requests
  - Multicast pass-through
  - VPN pass-through
  - Block Web features (Java, Cookies, Active X, HTTP Proxy)
  - DMZ
  - Universal Plug and Play (UPnP)
  - IP Forwarding (1-1 NAT)
  - Port Forwarding
  - Port Range Forwarding
  - IP-based access restriction
  - Custom access policy
- Services Management:
  - FTP
  - SSH
  - Telnet
  - SMTP
  - HTTP
  - Custom service
- 4-Port Gigabit Ethernet Switch:
  - Switch management
  - 16 VLANs
  - Port mirroring
  - Link aggregation
- Web-based administration
- The GCD-RGA is also an Application Server blade that supports the RGA Conference application. Refer to the RGA Conference feature for more information.

## Conditions

- The RGA Router feature is not supported for the first release. This feature will be supported in a future build.
- If using a 9.5" Gateway (CHS2U GW-US) or Base (CHS2UG B-US) chassis the GCD-RGA and GCD-SVR2 cannot be installed in the same chassis.

- By default the RGA has the DHCP server enabled and will provide a device an IP Address within the range of 192.168.1.100 ~ 192.168.1.150.
- Do not plug the RGA LAN into a customer’s existing network without first verifying the RGA’s DHCP server will not cause a conflict. If needed connect the support PC directly to the RGA to make configuration changes before connecting the existing network.
- To connect to the RGA one of the following Web Browsers must be used:
  - ❑ Internet Explorer® version 9.0 or higher
  - ❑ Google Chrome™ version 27.0 or higher
  - ❑ Mozilla® Firefox® version 22.0 or higher
- By default the GCD-RGA WAN port will get the IP Address set in Program 10-55-01 for the slot in which the GCD-RGA was installed.
- If using the GCD-RGA for the RGA Conference application only the WAN port should be connected to the existing customer network and the LAN ports should not be used. If the Router functionality of the GCD-RGA will be used then the LAN ports can be used and connected to the existing customer network.

### Default Settings

DHCP Server enabled

LAN Port IP Address 192.168.1.1

WAN Port IP Address assigned from Program 10-55-01

### System Availability

#### Terminals

None

#### Required Component(s)

SV9100 Software Version 1.00 or higher

GCD-RGA Blade

### Related Features

None



## Guide to Feature Programming

The **Level 1**, **Level 2** and **Level 3** columns indicate the programs that are assigned when programming this feature in the order they are most commonly used. These levels are used with PCPro and WebPro wizards for feature programming.

- Level 1 – these are the most commonly assigned programs for this feature.
- Level 2 – these are the next most commonly assigned programs for this feature.
- Level 3 – these programs are not often assigned and require an expert level working knowledge of the system to be properly assigned.

Program Number	Program Name/Description	Input Data	Default	Level		
				1	2	3
10-12-01	<b>GCD-CP10 Network Setup – IP Address</b> Assign the IP Address.	0.0.0.0 ~ 126.255.255.254 128.0.0.1 ~ 191.255.255.254 192.0.0.1 ~ 223.255.255.254	192.168.0.10	✓		
10-12-03	<b>GCD-CP10 Network Setup – Default Gateway</b> Set the default gateway for system to IP Address provided by IT department.	0.0.0.0 ~ 126.255.255.254 128.0.0.1 ~ 191.255.255.254 192.0.0.1 ~ 223.255.255.254	0.0.0.0		✓	
10-55-01	<b>Package Network Setup – IP Address</b> Define the IP Address for the GCD-RGA. ➡ <i>When the blade is deleted from the system using Program 90-05, the programming for the slot in 10-55 is set back to default.</i>	0.0.0.0 ~ 126.255.255.254 128.0.0.1 ~ 191.255.255.254 192.0.0.1 ~ 223.255.255.254	172.16.1.100	✓		
10-55-04	<b>Package Network Setup – Sub Net Mask</b> Define the subnet mask for the GCD-RGA.	128.0.0.0   192.0.0.0   224.0.0.0  240.0.0.0   248.0.0.0   252.0.0.0  254.0.0.0   255.0.0.0  255.128.0.0   255.192.0.0  255.224.0.0   255.240.0.0  255.248.0.0   255.252.0.0  255.254.0.0   255.255.0.0  255.255.128.0   255.255.192.0  255.255.224.0   255.255.240.0  255.255.248.0   255.255.252.0  255.255.254.0   255.255.255.0  255.255.255.128  255.255.255.192  255.255.255.224  255.255.255.240  255.255.255.248  255.255.255.252  255.255.255.254  255.255.255.255	255.255.0.0		✓	
10-55-05	<b>Package Network Setup – Default Gateway</b> Define the default gateway for the GCD-RGA.	0.0.0.0 ~ 126.255.255.254 128.0.0.1 ~ 191.255.255.254 192.0.0.1 ~ 223.255.255.25	0.0.0.0	✓		

## Operation

Refer to the UNIVERGE SV9100 RGA Multimedia Conference Solution manual.

## Ringdown Extension, Internal/External

### Description

With a Ringdown Extension, a user can call another extension, outside number, or Speed Dialing number by lifting the handset. The call automatically goes through – there is no need for the user to dial digits or press additional keys. Ringdown Extensions are frequently used for lobby telephones, where the caller just lifts the handset to get the information desk or off-site Reservation Desk.

After the Ringdown Extension user lifts the handset, ringdown occurs after a programmable time. Depending on the setting of this time, the extension user may be able to place other calls before the ringdown goes through.

This feature can also be used as an off-hook alarm application. For example, if a patient in a care facility fails to return the handset to the cradle, it routes to a care givers station after a programmed time.

### Conditions

- Ringdown extension has no effect on an extension current (active) call.
- The Ringdown Extension user can lift the handset or press Speaker to initiate ringdown.
- If the Ringdown/Hotline destination is a speed dial bin, the appropriate service code must precede the bin number.
- Ringdown Extension can use Speed Dial - System/Group/Station numbers (and follow their trunk routing) as the destination number.
- Ringdown Extension follows Call Forwarding. For example, the ringdown destination can forward their calls. When the Ringdown Extension user lifts the handset, ringdown automatically calls the extension to which calls are forwarded.
- If the Ringdown Extension user hears busy tone when they lift the handset, they can Camp-On to the destination, leave a Callback or activate Off-Hook Signaling.
- The ringdown destination user can activate Do Not Disturb. When the Ringdown Extension user lifts the handset, they hear DND. If enabled, the Ringdown Extension user can override the destination DND.
- If the destination extension has Handsfree Answerback enabled, the call voice announces. If the destination extension has Forced Intercom Ringing enabled, the call rings.
- A Call Arrival (CAR) Key or Virtual Extension can be a ringdown destination. This would allow a front door key to be programmed on every extension.
- Delayed Ringdown can occur by setting the Hotline Start Timer. However, Ringdown does not occur if the Hotline Start Timer is set longer than the Extension Dial Tone Timer.
- Use the @ code to make an outbound call automatically forward to a DISA Trunk or to VM Auto Attendant. This code can be used only on ISDN outbound calls. Internal calls and analog outbound calls are not supported.

## Default Settings

Disabled

## System Availability

### Terminals

All Terminals

### Required Component(s)

None

## Related Features

- ↳ **Callback**
- ↳ **Call Arrival (CAR) Keys**
- ↳ **Call Forwarding**
- ↳ **Call Waiting/Camp-On**
- ↳ **Do Not Disturb**
- ↳ **Handsfree Answerback/Forced Intercom Ringing**
- ↳ **Off-Hook Signaling**
- ↳ **Speed Dial – System/Group/Station**
- ↳ **Video Conference with Web RTC**

## Guide to Feature Programming

The **Level 1**, **Level 2** and **Level 3** columns indicate the programs that are assigned when programming this feature in the order they are most commonly used. These levels are used with PCPro and WebPro wizards for feature programming.

- Level 1 – these are the most commonly assigned programs for this feature.
- Level 2 – these are the next most commonly assigned programs for this feature.
- Level 3 – these programs are not often assigned and require an expert level working knowledge of the system to be properly assigned.

Program Number	Program Name/Description	Input Data	Default	Level		
				1	2	3
20-06-01	<b>Class of Service for Extensions</b> Assign a Class of Service (1 ~ 15) to an extension.	Day Night/Mode: 1 ~ 8 Class of Service of Extensions (1 ~ 15)	Extension port 101 = Class 15 All other extension port = Class 1	✓		
20-08-01	<b>Class of Service Options (Outgoing Call Service) – Intercom Calls</b> Turn Off or On Intercom calling for the extension.	0 = Off 1 = On	COS 1 ~ 15 = 1	✓		
20-08-09	<b>Class of Service Options (Outgoing Call Service) – Hotline/Extension Ringdown</b> Turn Off or On Hotline (Ringdown). If disabled in Class of Service, the settings in Program 21-11 below have no effect.	0 = Off 1 = On	COS 1 ~ 15 = 0	✓		
21-01-09	<b>System Options for Outgoing Calls – Ringdown Extension Timer (Hotline Start)</b> After the user lifts the handset, the extension automatically calls the ringdown destination after this time. A setting of 0 immediately rings the programmed extension. Any other setting delays the ringdown the number of seconds programmed.	0 ~ 64800 seconds	5	✓		
21-11-01	<b>Extension Ringdown (Hotline) Assignment</b> Program the ringdown (Hotline) source and destination (target) number, up to 24 digits (960 Hotline assignments). Remember to include the trunk access code (usually 9) in front of the number when dialing outside numbers. When programming Speed Dial – System numbers as the destination, the entry should be #2 + bin number (the service code for Speed Dialing and the Speed Dial bin number).	Maximum of 24 digits 0 ~ 9, *, #, Pause, Hook Flash, @ (Code to wait for answer supervision)	No Setting	✓		

## Operation

### To place a call if your extension has ringdown programmed:

1. Lift the handset.
  - ◇ *If you want to place a trunk call, press a line key before lifting the handset.*
  - ◇ *Depending on the setting of your ringdown timer, you may be able to dial an Intercom call before your ringdown goes through.*
  - ◇ *If the destination has Handsfree Answerback enabled, your call voice announces. If the destination has Forced Intercom Ringing enabled, your call rings.*

### To answer a call if you are another extension ringdown destination:

1. Speak toward the telephone to answer the incoming voice announcement.

- OR -

Lift the handset or press **Speaker** to answer ringing Intercom call.

## Ring Groups

### Description

Ring Groups determine how trunks ring extensions. Generally, trunks ring extensions only if Ring Group programming allows. For example, to make a trunk ring an extension:

- Assign the trunk and the extension to the same Ring Group.
- In the extension Ring Group programming, assign ringing for the trunk.

Any number of extensions and trunks can be in a specific group. The system allows:

- Ring Groups = 1~100
- In-Skin Voice Mail = 102

If an extension has a line key for the trunk, Ring Group calls ring the line key. If the extension does not have a line key, the trunk rings the line appearance key. If an extension has a key for a trunk that is not in its ring group, the trunk follows Access Map programming.

### Conditions

- DIL trunks disregard ring group programming until DIL overflow.

### Default Settings

All trunks are in Ring Group 1. The first 16 extensions ring for trunk calls and all other extensions only flash.

### System Availability

#### Terminals

All Multiline Terminals and Single Line Telephones

#### Required Component(s)

None

## Related Features

- ➔ **Automatic Route Selection (ARS)**
- ➔ **Contact Center**
- ➔ **Direct Inward Dialing (DID)**
- ➔ **Direct Inward Line (DIL)**
- ➔ **Direct Inward System Access (DISA)**
- ➔ **ISDN Compatibility**
- ➔ **Night Service**
- ➔ **Programmable Function Keys**

## Guide to Feature Programming

The **Level 1**, **Level 2** and **Level 3** columns indicate the programs that are assigned when programming this feature in the order they are most commonly used. These levels are used with PCPro and WebPro wizards for feature programming.

- Level 1 – these are the most commonly assigned programs for this feature.
- Level 2 – these are the next most commonly assigned programs for this feature.
- Level 3 – these programs are not often assigned and require an expert level working knowledge of the system to be properly assigned.

Program Number	Program Name/Description	Input Data	Default	Level		
				1	2	3
15-07-01	<b>Programmable Function Keys</b> Assign function keys as line (code *01 + trunk number) or Call Appearance (CAP) Keys [code *08 + CAP Key orbit 0001 ~ 9999 (or 0000 for auto assign)].	Trunks: 1 ~ 400 Line Key 1 ~ 48 0 ~ 99 (Normal Function Code 751 by default) *00 ~ *99 (Appearance Function Code) (Service Code 752 by default)	Refer to the Programming Manual for default values.		✓	
20-13-49	<b>Class of Service Options (Supplementary Service) – BLF Indication on CO Incoming State</b> Turn Off or On BLF Indication on CO Incoming State.	0 = Off 1 = On	COS 1 ~ 15 = 0		✓	
22-01-04	<b>System Options for Incoming Calls – DIL No Answer Recall Time</b> A DIL that rings its programmed destination longer than this time diverts to the DIL No Answer Ring Group (set in Program 22-08).	0 ~ 64800 seconds	0		✓	



Program Number	Program Name/Description	Input Data	Default	Level		
				1	2	3
22-02-01	<p><b>Incoming Call Trunk Setup</b></p> <p>Assign the incoming trunk type (0) for each trunk. There is one item for each Night Service Mode.</p> <p>➔ <i>This option must be set to 0 for Ring Groups to work.</i></p>	<p>Day/Night Mode: 1~8</p> <p>0 = Normal</p> <p>1 = VRS (second dial tone if no VRS installed)</p> <p>2 = DISA</p> <p>3 = DID</p> <p>4 = DIL</p> <p>5 = E&amp;M Tie line</p> <p>6 = Delayed VRS</p> <p>7 = ANI/DNIS</p> <p>8 = DID(DDI) Mode Switching</p>	0		✓	
22-04-01	<p><b>Incoming Extension Ring Group Assignment</b></p> <p>Assign extensions (up to 48) to Ring Groups. Calls ring extensions according to Ring Group programming. There are 100 available ring groups.</p>	Maximum of eight digits.	Extensions 101 ~ 108 (first eight ports) ring for incoming Ring Group 1 calls. No other extensions ring for incoming Ring Group 1 calls.	✓		
22-05-01	<p><b>Incoming Trunk Ring Group Assignment</b></p> <p>Assign trunks to ring groups.</p>	<p>Trunks 1 ~ 400</p> <p>Incoming Group Number for Day/Night Mode (1 ~ 8):</p> <p>0 = (No Setting)</p> <p>001 ~ 100 = (Incoming Group)</p> <p>102 = (In-Skin/ External Voice Mail or InMail)</p>	1	✓		
22-06-01	<p><b>Normal Incoming Ring Mode</b></p> <p>Define whether or not an extension should ring for the Normal Incoming Ring Mode.</p>	<p>0 = No Ring</p> <p>1 = Ring</p>	1	✓		
22-08-01	<p><b>DIL/IRG No Answer Destination</b></p> <p>For DIL Delayed Ringing, assign the DIL No Answer Ring Group. An unanswered DIL rings this group after the DIL No Answer Time (Program 22-01-04) expires. DIL Delayed Ringing can also reroute outside calls ringing a Ring Group In-Skin/External Voice Mail, or Centralized Voice Mail.</p>	<p>0 = (No Setting)</p> <p>001 ~ 100 = Incoming Ring Group</p> <p>102 = (In-Skin/External Voice Mail or InMail)</p>	1		✓	
22-12-01	<p><b>DID Intercept Ring Group</b></p> <p>For each DID Translation Table, assign the destination for DID Intercept. The destination can be a Ring Group, In-Skin/External Voice Mail, or Centralized Voice Mail. For each table, make a separate entry for each Night Service mode.</p>	<p>0 = (No Setting)</p> <p>001 ~ 100 = Incoming Ring Group</p> <p>102 = (In-Skin/External Voice Mail or InMail)</p>	1		✓	

Program Number	Program Name/Description	Input Data	Default	Level		
				1	2	3
25-03-01	<b>VRS/DISA Transfer Ring Group With Incorrect Dialing</b> Set the transfer destination for each DISA and Automated Attendant (OPA) trunk. The destination can be a Ring Group or Voice Mail. Make a separate entry for each Night Service mode. ➔ For incoming calls, Ring Group programming (Program 22-04/Program 22-05) overrides Access Map programming (Program 14-07/Program 15-06).	Ring Groups: 1 ~ 100 Trunk Ports: 001 ~ 400 Day/Night Mode: 1 ~ 8 0 = Disconnect 1 ~ 100 = Incoming Ring Group 102 = In-Skin/External Voice Mail or InMail 104 = Speed Dial Bin (table Program 25-15-01)	0		✓	

Use the charts below to program the following example:

For this extension . . . <sup>1, 2</sup>			
301	Trunk 1 Rings	Trunk 2 Flashes	Trunk 3 Flashes
302	Trunk 1 Flashes	Trunk 2 Rings	Trunk 3 Flashes
303	Trunk 1 Flashes	Trunk 2 Flashes	Trunk 3 Rings

<sup>1</sup> Trunks ring the same in the day as at night.

<sup>2</sup> MLT has trunk appearances not CAP keys.

Program 22-04 : Incoming Extension Ring Group Assignment			
Ring Group >	1	2	3
Ext. 301	1	0 <sup>1</sup>	0 <sup>1</sup>
Ext. 302	0 <sup>1</sup>	1	0 <sup>1</sup>
Ext. 303	0 <sup>1</sup>	0 <sup>1</sup>	1

1 = Extension rings

0 = Extension does not ring

<sup>1</sup> To allow extension user to answer flashing line, be sure to give extension incoming access to the trunk in Program 14-07 and Program 15-06.

Program 22-05 : Incoming Trunk Ring Group Assignment			
Ring Group <sup>1&gt;</sup>	1	2	3
Trunk 1	X	-	-
Trunk 2	-	X	-
Trunk 3	-	-	X

X = Trunk assigned to indicated Ring Group

<sup>1</sup> Make the same Program 22-04 entry for all Night Service modes.

## Operation

Refer to [Central Office Calls, Answering on page 2-206](#).

## Room Monitor

### Description

Room Monitor lets an extension user listen to the sounds in a co-workers area. For example, the receptionist could listen for sounds in the warehouse when it is left unattended. To use Room Monitor, the initiating extension **and** the receiving extension must activate it.

When using multiline terminals for monitoring, an extension user can monitor only one extension at a time. However, many extensions can monitor the same extension at the same time. However, only one single line telephone can monitor another single line telephone at a time.

### Room Monitor for Single Lines

This option enables you to monitor the room status through your single line telephones. Between multiline terminals, the monitored room status is picked up by the telephone microphone and the activity is heard through the speaker of the monitoring multiline terminal. Between single line telephones, at the station to be monitored, a user goes off-hook and dials a service code and the extension number of the monitoring telephone. At the monitoring station, a user goes off-hook and dials a service code and the extension number of the monitored telephone. The activity of the area where the monitored telephone is placed can then be heard at the monitoring telephone. This service is available until the handset of the monitored telephone is placed on-hook.



CAUTION

*The use of monitoring, recording, or listening devices to eavesdrop, monitor, retrieve, or record telephone conversation or other sound activities, whether or not contemporaneous with transmission, may be illegal in certain circumstances under federal or state laws. Legal advice should be sought prior to implementing any practice that monitors or records any telephone conversation. Some federal and state laws require some form of notification to all parties to a telephone conversation, such as using a beep tone or other notification methods or requiring the consent of all parties to the telephone conversation, prior to monitoring or recording the telephone conversation. Some of these laws incorporate strict penalties.*

### Conditions

- Room Monitor is for listening only. It does not allow conversation between the monitoring and monitored extensions.
- An extension user cannot monitor an Attendant.
- A multiline terminal user cannot monitor a single line telephone, and a single line telephone cannot monitor a multiline terminals.
- Call Arrival (CAR) Key (virtual extension) keys do not support Room Monitor Programmable Function keys (code 39).
- Room Monitor for single line telephones can be used with the Hotel/Motel feature.
- For a multiline terminal, Room Monitor requires uniquely programmed function keys.

## Default Settings

Disabled

## System Availability

### Terminals

All Multiline Terminals and Single Line Telephones

### Required Component(s)

None

## Related Features

- ➔ [Hotel/Motel](#)
- ➔ [Programmable Function Keys](#)

## Guide to Feature Programming

The **Level 1**, **Level 2** and **Level 3** columns indicate the programs that are assigned when programming this feature in the order they are most commonly used. These levels are used with PCPro and WebPro wizards for feature programming.

- Level 1 – these are the most commonly assigned programs for this feature.
- Level 2 – these are the next most commonly assigned programs for this feature.
- Level 3 – these programs are not often assigned and require an expert level working knowledge of the system to be properly assigned.

Program Number	Program Name/Description	Input Data	Default	Level		
				1	2	3
11-14-17	<b>Service Code Setup (for Hotel) – Hotel Room Monitor</b> Customize the service code (675 by default) to be used for Room Monitor.	MLT, SLT 0 ~ 9, *, # Maximum of eight digits	675		✓	
15-07-01	<b>Programmable Function Keys</b> Assign a function key as a Room Monitor key (code 39) for both the extension being monitored and the extension initiating Room Monitor.	Line Key 1 ~ 48 0 ~ 99 (Normal Function Code 751 by default) *00 ~ *99 (Appearance Function Code) (Service Code 752 by default)	Refer to the Programming Manual for default values.	✓		

Program Number	Program Name/Description	Input Data	Default	Level		
				1	2	3
20-06-01	<b>Class of Service for Extensions</b> Assign a Class of Service (1 ~ 15) to an extension.	Day Night/Mode: 1 ~ 8 Class of Service of Extensions (1 ~ 15)	Extension port 101 = Class 15 All other extension port = Class 1	✓		
20-13-11	<b>Class of Service Options (Supplementary Service) – Room Monitor, Initiating Extension</b> Turn Off or On an extension user ability to Room Monitor other extensions.	0 = Off 1 = On	COS 1 ~ 15 = 0	✓		
20-13-12	<b>Class of Service Options (Supplementary Service) – Room Monitor, Extension Being Monitored</b> Turn Off or On an extension ability to be monitored by other extensions.	0 = Off 1 = On	COS 1 ~ 15 = 0	✓		
42-03-12	<b>Class of Service Options (Hotel/Motel) – SLT Room Monitor</b> Enable/Disable a single line telephone user ability to use Room Monitor.	0 = Disable 1 = Enable	COS 1 ~ 15 = 0	✓		

### Multiline Room Monitoring

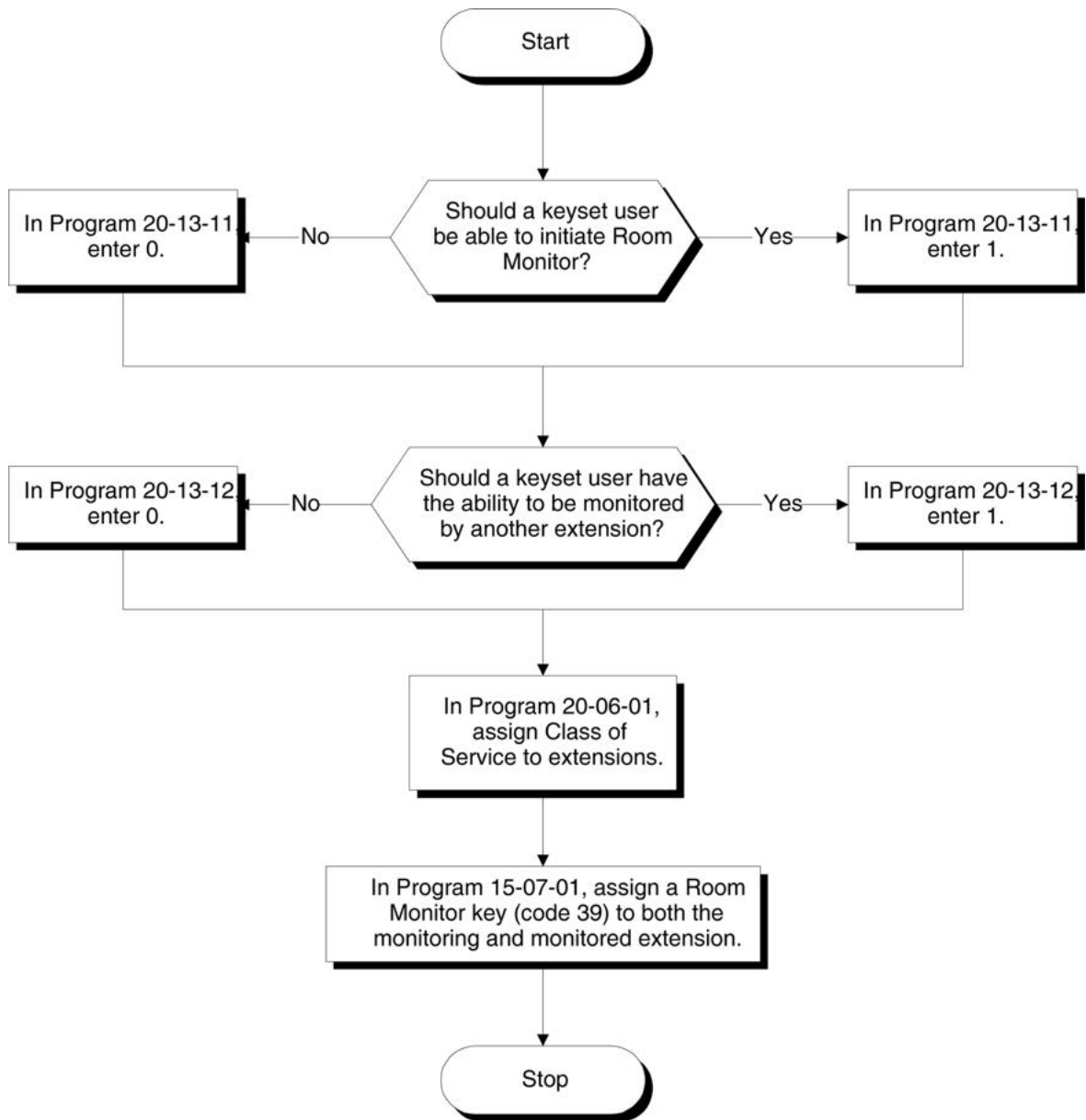

### Single Line Telephone Room Monitoring

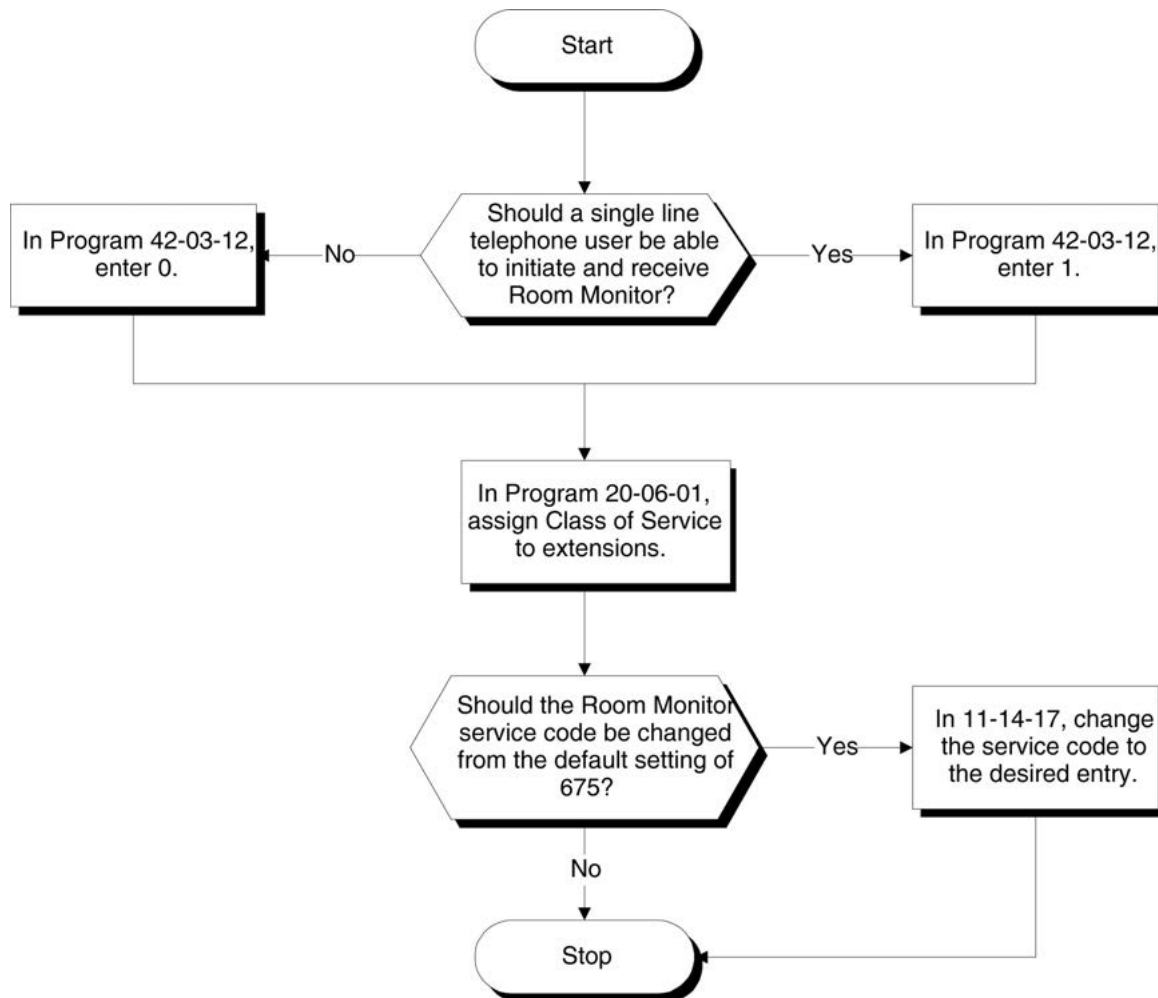

## Operation



*You must activate Room Monitor at the extension initiating the monitor and at the extension you want to monitor. You can only listen to one extension at a time.*



## Multiline Terminals

### To activate Room Monitor from an idle Multiline Terminal (initiating extension):

1. Press the **Room Monitor** key (Program 15-07 or SC 751: 39).
2. Dial the number of extension you want to monitor.
  - ◇ *You can place and answer other calls while Room Monitor is active.*

### To activate Room Monitor from an idle Multiline Terminal (extension to be monitored):

1. Press **Room Monitor** key (Program 15-07 or SC 751: 39).
2. Dial the number of the extension where you are located.
  - ◇ *For example, if you are at extension 106, dial 106.*
  - ◇ *You can place and answer other calls while Room Monitor is active.*

### To cancel Room Monitor (at either extension):

1. Press the **Room Monitor** key at both the initiating extension and the monitored extension.

## Single Line Telephones

### To activate Room Monitor (at the initiating extension):

1. Lift the handset at the telephone which is monitoring another telephone.
2. Dial **675**.
3. Dial **2**.
4. Dial number of extension number, which will be monitored.
  - ◇ *You cannot place or answer other calls while Room Monitor is active.*

### To activate Room Monitor (at the extension to be monitored):

1. Lift the handset at the telephone to be monitored.
2. Dial **675**.
3. Dial **1**.
4. Dial number of the extension number, which is monitoring the telephone.
5. Place the handset on the desk, placing the handset transmitter towards the room.
  - ◇ *You cannot place or answer other calls while Room Monitor is active.*

### To cancel Room Monitor (at either extension):

1. Hang up the handsets for both the monitored and the monitoring telephones.



### Description

Save Number Dialed allows an extension user to save their last outside number dialed and easily redial it later on. For example, an extension user can recall a busy or unanswered number without manually dialing the digits. The system retains the saved number until the user stores a new one in its place or clears the stored one.

Save Number Dialed saves in system memory a dialed number of up to 24 digits. The number can be any combination of digits 0~9, # and \*. The system remembers the digits regardless of whether the call was answered, unanswered or busy. The system normally uses the same trunk group as for the initial call. However, the extension user can preselect a specific trunk if desired.

### Conditions

- For systems with Automatic Route Selection, ARS selects the trunk for the call unless the user preselects.
- Function keys simplify Save Number Dialed operation.

### Default Settings

Enabled

### System Availability

#### Terminals

All Terminals

#### Required Component(s)

None

## Related Features

- ➔ [Automatic Route Selection \(ARS\)](#)
- ➔ [Central Office Calls, Placing](#)
- ➔ [Dial Tone Detection](#)
- ➔ [Last Number Redial](#)
- ➔ [Programmable Function Keys](#)
- ➔ [Repeat Redial](#)

## Guide to Feature Programming

The **Level 1**, **Level 2** and **Level 3** columns indicate the programs that are assigned when programming this feature in the order they are most commonly used. These levels are used with PCPro and WebPro wizards for feature programming.

- Level 1 – these are the most commonly assigned programs for this feature.
- Level 2 – these are the next most commonly assigned programs for this feature.
- Level 3 – these programs are not often assigned and require an expert level working knowledge of the system to be properly assigned.

Program Number	Program Name/Description	Input Data	Default	Level		
				1	2	3
11-12-13	<b>Service Code Setup (for Service Access) – Saved Number Dial</b> Customize the service code used for dialing a saved number.	MLT, SLT 0 ~ 9, *, # Maximum of eight digits	715		✓	
11-12-18	<b>Service Code Setup (for Service Access) – Clear Saved Number Dialing Data</b> Define the service code for Clear Save Number Dialing List if it is not acceptable.	MLT, SLT 0 ~ 9, *, # Maximum of eight digits	785		✓	
15-07-01	<b>Programmable Function Keys</b> Assign a function key as a Save key (code 30).	Line Key 1 ~ 48 0 ~ 99 (Normal Function Code 751 by default) *00 ~ *99 (Appearance Function Code) (Service Code 752 by default)	Refer to the Programming Manual for default values.	✓		

## Operation

### To save the outside number you just dialed (up to 24 digits):



*Use this feature before hanging up.*

NOTE

#### Multiline Terminal

1. Press the **Save Number Dialed** key (Program 15-07 or SC 751: 30).

#### Single Line Telephone

1. Hookflash.
2. Dial **715**.

### To redial a saved number:

#### Multiline Terminal

1. Press an idle trunk line key.
    - ◇ *This selects a specific trunk for the call.*
  2. Press the **Save Number Dialed** key (Program 15-07 or SC 751: 30).
    - ◇ *The stored number dials out.*
- OR -
1. Press **Speaker**.
  2. Dial **715**.

- OR -

Press **Save Number Dialed** key (Program 15-07 or SC 751: 30).

- ◇ *Save Number Dialed automatically selects a trunk from the same group as your original call.*
- ◇ *The stored number dials out.*

#### Single Line Telephone

1. Go off-hook.
2. Dial **715**.

### To view the number you have saved from a multiline terminal with a display:

1. Press the **Save Number Dialed** key (Program 15-07 or SC 751: 30).
  - ◇ *The stored number displays for 10 seconds.*
  - ◇ *The stored number dials out if you:*
    - Lift the handset,*
    - Press an idle line key,*

- *Press the Speaker key.*
- 2. Press the **Exit** key.

**To clear your saved number:**

Multiline Terminal

1. Press **Speaker**.
2. Dial **785**.
3. Press **Speaker** to hang up.

Single Line Telephone

1. Lift the handset and dial **785**.
2. Hang up.

## Secondary Incoming Extension

### Description

Secondary Incoming Extensions (SIEs) are incoming appearance keys of actual stations assigned in the system. SIE keys are assigned to programmable function keys and can appear on an individual station, or multiple stations. Incoming internal calls, ringing DIL/Tie/DID/CO Transfer calls, or call forwarded calls can be picked up from an SIE.

### Conditions

- Calls can be originated from a Secondary Incoming Extension, but the actual station cannot place or answer calls.
- Off-Hook ringing is provided with calls ringing to Secondary Incoming Extensions.
- Secondary Incoming Extensions are forwarded when the actual station is set for call forwarding.
- SIE keys can appear on an individual station, or multiple stations.
- A station can have more than one SIE key assigned.
- Up to 32 calls can be queued waiting on an SIE key.
- When a Secondary Incoming Extension call is received and answered while the user is on an outside line, the first call can be automatically put on hold.
- If a trunk call rings a Secondary Incoming Extension, to answer the call, the station must be programmed with the direct trunk appearance key or an available CAP key and the SIE must be programmed to allow the call to come off the SIE key and appear on the line or CAP key.
- The same SIE key cannot be programmed on multiple programmable function keys on the same multiline terminal.
- An SIE key does not ring during an Intercom Voice call to the actual station.
- If multiple CAR/SIE/VE keys are ringing on a station at the same time, the CAR/SIE/VE key on the lowest Line Key is answered first.
- The system can be programmed to blink the page number of a DT300/DT700 DESI-Less terminal when it receives an incoming call, or switch to the page of the incoming call. Also, a default page can be defined for the DESI-Less terminal to change to when it goes idle or when it has answered a call.
- DESI-Less screen page switching only applies to idle terminals. If a terminal is not idle, the screen will not switch if another call comes in until the phone goes idle.

### Default Settings

None

## System Availability

### Terminals

All Multiline Terminals

### Required Component(s)

None

## Related Features

- ➔ **Call Appearance (CAP) Keys**
- ➔ **Call Arrival (CAR) Keys**
- ➔ **Call Waiting/Camp-On**
- ➔ **Video Conference with Web RTC**

## Guide to Feature Programming

The **Level 1**, **Level 2** and **Level 3** columns indicate the programs that are assigned when programming this feature in the order they are most commonly used. These levels are used with PCPro and WebPro wizards for feature programming.

- Level 1 – these are the most commonly assigned programs for this feature.
- Level 2 – these are the next most commonly assigned programs for this feature.
- Level 3 – these programs are not often assigned and require an expert level working knowledge of the system to be properly assigned.



Program Number	Program Name/Description	Input Data	Default	Level		
				1	2	3
11-04-01	<b>Virtual Extension Numbering</b> Assign virtual extension numbers.	Maximum of eight digits.	Virtual Extension Port No. 1 ~ 99 = Virtual Extension Number 201 ~ 299 Virtual Extension Port No. 100 ~ 512 = No Setting		✓	
15-01-01	<b>Basic Extension Data Setup – Extension Name</b> Define the extension/virtual extension name.	Maximum of 12 characters.	STA 101 = Ext 101 STA 102 = Ext 102, etc.		✓	
15-02-07	<b>Multiline Telephone Basic Data Setup – Automatic Hold for CO lines</b> When talking on a CO call and another CO line key is pressed, place the original trunk on Hold or Disconnect it.	0 = Hold 1 = Disconnect (Cut)	1		✓	
15-02-21	<b>Multiline Telephone Basic Data Setup – Virtual Extension Access Mode (When idle Virtual Extension key pressed)</b> Determine whether a Virtual Extension/Call Arrival Key (CAR) should function as a DSS key, a Virtual Extension, or a CAR key. When DSS (0) is selected, the key functions as a DSS key to the extension and for incoming calls to that extension. When Outgoing (1) is selected, the key functions as a virtual extension and can be used for incoming and outgoing calls. When Ignore (2) is selected, the key functions as a CAR key and can receive incoming calls only.	Virtual Extension Key Mode 0 = DSS 1 = OTG (Outgoing) 2 = Ignore	2		✓	
15-02-30	<b>Multiline Telephone Basic Data Setup – Toll Restriction Class</b> Select the Toll Restriction Class used when placing a call from a virtual extension.	0 = Vir. Ext. (Virtual Extension Class) 1 = Real Ext. (Real Extension Class)	1		✓	
15-07-01	<b>Programmable Function Keys</b> Assign the SIE key to the Multiline extension.	Line Key 1 ~ 48 0 ~ 99 (Normal Function Code 751 by default) *00 ~ *99 (Appearance Function Code) (Service Code 752 by default)	Refer to the Programming Manual for default values.	✓		

Program Number	Program Name/Description	Input Data	Default	Level		
				1	2	3
15-08-01	<p><b>Incoming Virtual Extension Ring Tone Setup</b></p> <p>When an extension or a virtual extension is assigned to the function key on the key telephone, select the ring tone when receiving a call on that key.</p> <p>For CAR keys, only tone pattern 1 can be used. The remaining patterns are not checked with this feature.</p>	ICM Tone Pattern, 0 = Pattern 1 1 = Pattern 2 2 = Pattern 3 3 = Pattern 4 4 = Incoming Ring Tone Extension 5 = Tone Pattern 5 6 = Tone Pattern 6 7 = Tone Pattern 7 8 = Tone Pattern 8	0		✓	
15-09-01	<p><b>Virtual Extension Ring Assignment</b></p> <p>Assign the ring options for an extension Virtual Extension Key or Virtual Extension Group Answer Key which is defined in Program 15-07.</p>	Mode 1: 0 = No Ring 1 = Ring	0	✓		
15-10-01	<p><b>Incoming Virtual Extension Ring Tone Order Setup</b></p> <p>When two or more virtual extensions are set on a function key on the telephone, and the tone pattern by which the sound of each extension differs, set up the priority of ring sound.</p>	0 = Tone Pattern 1 1 = Tone Pattern 2 2 = Tone Pattern 3 3 = Tone Pattern 4 4 = Incoming Extension Ring Tone 5 = Tone Pattern 5 6 = Tone Pattern 6 7 = Tone Pattern 7 8 = Tone Pattern 8	Priority order: 1 = 0 (Tone Pattern 1) 2 = 1 (Tone Pattern 2) 3 = 2 (Tone Pattern 3) 4 = 3 (Tone Pattern 4)		✓	
15-11-01	<p><b>Virtual Extension Delayed Ring Assignment</b></p> <p>Assign the delayed ringing options for an extension Virtual Extension or Virtual Extension Group Answer keys (defined in Program 15-09).</p>	KY01 Mode 1: 0 = Immediate Ring 1 = Delayed Ring	0		✓	
15-18-01	<p><b>Virtual Extension Key Enhanced Options – Virtual Extension Key Operation Mode</b></p> <p>Define whether calls to a Virtual Extension key land on the virtual key or on the extension/CAP/CO appearance.</p>	0 = Release (Release to Line Appearance) 1 = Land On the Key	0		✓	
15-18-02	<p><b>Virtual Extension Key Enhanced Options – Display mode when placing a call on Virtual Extension Key</b></p> <p>Define whether calls to or from a Virtual Extension Key display the Virtual Extension key name or the name of the extension on which it resides.</p>	0 = Secondary Extension Name 1 = Actual Station Name	0		✓	
20-04-03	<p><b>System Options for Virtual Extensions – CAR/SIE/Virtual Extension Delay Interval</b></p> <p>CAR Keys/SIE Keys/Virtual Extensions set for Delayed Ringing (see Program 15-11) ring the extension after this interval.</p>	0 ~ 64800 seconds	10		✓	

Program Number	Program Name/Description	Input Data	Default	Level		
				1	2	3
20-06-01	<b>Class of Service for Extensions</b> Assign a Class of Service (1~15) to extensions.	Day Night/Mode: 1 ~ 8 Class of Service of Extensions (1 ~ 15)	Extension port 101 = Class 15 All other extension port = Class 1		✓	
20-07-10	<b>Class of Service Options (Administrator Level) – Programmable Function Key Programming (Appearance Level)</b> Turn Off or On an extension user ability to program the Appearance function keys using Service Code 752.	0 = Off 1 = On	COS 1 ~ 15 = 1		✓	
20-10-08	<b>Class of Service Options (Answer Service) – Virtual Extension Off-Hook Answer</b> Turn Off or On an extension user ability to answer an incoming call on a Call Arrival (CAR)/Secondary Incoming Extension (SIE)/ Virtual Extension by lifting the handset.	0 = Off 1 = On	COS 1 ~ 15 = 1		✓	
20-13-27	<b>Class of Service Options (Supplementary Service) – Busy on Seizing Virtual Extension</b> If set to 1, you can call a busy extension which is talking on a virtual extension key. Program 20-13-06 (Call Waiting) must be set to off for this option to work.	0 = Off 1 = On	COS 1 ~ 15 = 1		✓	
21-01-15	<b>System Options for Outgoing Calls – Outgoing Disable on Incoming Line (Toll Restriction)</b> Enable/Disable the Outgoing Disable on Incoming Line feature.	0 = Disable 1 = Enable	0		✓	
23-04-01	<b>Ringing Line Preference for Virtual Extensions</b> When an extension has a virtual extension assigned to a Programmable Function Key, determine the priority for automatically answering the ringing calls when the handset is lifted. If 0 or 00 is selected, the user can lift the handset to answer a ringing call from any group.	00 ~ 64 (0 or 00=Don't Care)	00		✓	

## Operation

### To answer a call ringing a SIE key:

1. Press the flashing **SIE** key.

### To program a SIE key on a phone:

1. Press **Speaker**.
2. Dial **752**.
3. Press the key you want to program.
4. Dial **\*03**.
5. Dial the number of the extension you want to appear on the key.
6. Press **Hold** once for Immediate Ring, (skip to step 8 for Delayed Ring).
7. Dial the mode number in which the key rings.
8. Press hold a second time for Delayed Ring, or Skip to step 10.
9. Dial the mode number in which the key delays ringing.
10. Press **Speaker**.

## Secretary Call Pickup

### Description

Secretary Call Pickup lets a multiline terminal user easily reroute calls intended for a co-worker to themselves. By pressing a Secretary Call Pickup key, the user can have all calls to a co-worker's telephone ring or voice-announce theirs instead. Secretary Call Pickup is a simplified type of Call Forward with Follow Me for employees that work closely together. This feature could be helpful to customer service representatives that must frequently cover each other's clients. When a representative leaves their desk, an associate could press the Secretary Call Pickup key to intercept all their calls.

An extension can have a Secretary Call Pickup key for any number of extensions, limited only by the available number of programmable keys.

### Conditions

- Secretary Call Pickup is not available to single line telephone users.
- A Call Arrival (CAR) Key (virtual extension) cannot be programmed as the boss's extension.
- An extension user can also have Call Forwarding with Follow Me reroute a co-worker's calls to themselves.
- A multiline terminal can have a Secretary Call Pickup key for a single line telephone.
- agents should not use this feature.

### Default Settings

Disabled

### System Availability

#### Terminals

All Multiline Terminals

#### Required Component(s)

None

## Related Features

- ➔ [Call Forwarding with Follow Me](#)
- ➔ [Programmable Function Keys](#)
- ➔ [Secretary Call \(Buzzer\)](#)
- ➔ [Single Line Telephones, Analog 500/2500 Sets](#)

## Guide to Feature Programming

The **Level 1**, **Level 2** and **Level 3** columns indicate the programs that are assigned when programming this feature in the order they are most commonly used. These levels are used with PCPro and WebPro wizards for feature programming.

- Level 1 – these are the most commonly assigned programs for this feature.
- Level 2 – these are the next most commonly assigned programs for this feature.
- Level 3 – these programs are not often assigned and require an expert level working knowledge of the system to be properly assigned.

Program Number	Program Name/Description	Input Data	Default	Level		
				1	2	3
15-07-01	<b>Programmable Function Keys</b> Assign a function key for Secretary Call Pickup (42 + boss ext). Unlike Secretary Call, you do not have to program a corresponding key at the source and destination extensions.	Line Key 1 ~ 48 0 ~ 99 (Normal Function Code 751 by default) *00 ~ *99 (Appearance Function Code) (Service Code 752 by default)	Refer to the Programming Manual for default values.	✓		

## Operation

### To activate Secretary Call Pickup:

1. Press your Secretary Call Pickup key (Program 15-07 or SC 751: 42 + boss extension).
  - ◇ *Your Secretary Call Pickup key lights and the boss's telephone display shows "BOSS FWD>>".*
  - ◇ *Calls intended for covered extension, ring your telephone instead.*

### To cancel Secretary Call Pickup:

1. Press your lit Secretary Call Pickup key (Program 15-07 or SC 751: 42 + boss extension).

**To check a key Secretary Call Pickup assignment:**

1. Press the **Help** key.
2. Press your **Secretary Call Arrival (CAR)** key (Program 15-07 or SC 751: 42 + boss's extension).
3. Press the **Exit** key.

## Secretary Call (Buzzer)

### Description

Secretary Call lets two co-workers alert each other without disturbing their work. To have Secretary Call, both co-workers must have multiline terminals with Secretary Call buzzer keys. When a user presses their buzzer key, the system alerts the called extension by sending a splash tone and flashing the called extension buzzer key. The called user can respond by placing an intercom call to the calling party.

The called extension buzzer key continues to flash and the splash tone is heard until either user cancels the Secretary Call. A secretary could use this feature, for example, to get a message through to the boss in an important meeting. After being alerted, the boss could call the secretary when it is most convenient.

An extension can have a Secretary Call key for any number of extensions, limited only by the available number of programmable keys.

### Conditions

- Secretary Call is not available to single line telephone users.
- Secretary Call does not set up an Intercom call.
- When assigning Secretary Call, a user enters the associated extension number, not port number.
- Secretary Call requires a uniquely programmed function key.

### Default Setting

Disabled

### System Availability

#### Terminals

All Multiline Terminals

#### Required Component(s)

None



## Related Features

### ➔ Programmable Function Keys

## Guide to Feature Programming

The **Level 1**, **Level 2** and **Level 3** columns indicate the programs that are assigned when programming this feature in the order they are most commonly used. These levels are used with PCPro and WebPro wizards for feature programming.

- Level 1 – these are the most commonly assigned programs for this feature.
- Level 2 – these are the next most commonly assigned programs for this feature.
- Level 3 – these programs are not often assigned and require an expert level working knowledge of the system to be properly assigned.

Program Number	Program Name/Description	Input Data	Default	Level		
				1	2	3
15-07-01	<b>Programmable Function Keys</b> Assign function keys for Secretary Call buzzer (code 41 + the destination extension number). Both co-workers must have a buzzer key for each other.	Line Key 1 ~ 48 0 ~ 99 (Normal Function Code 751 by default) *00 ~ *99 (Appearance Function Code) (Service Code 752 by default)	Refer to the Programming Manual for default values.	✓		

## Operation

### To buzz your secretary or boss:

1. Do not lift the handset.
2. Press the buzzer key (Program 15-07 or SC 751: 41 + secretary extension).
  - ◇ *Your boss or secretary hears ringing.*
  - ◇ *Your buzzer key lights steadily.*
  - ◇ *Your boss's or secretary's buzzer key flashes fast.*
  - ◇ *The telephone continues to ring until the Secretary Call key is pressed.*

### To check to see who left you a Secretary Call:

1. Do not lift the handset.
2. Press the **Help** key.
3. Press the **Secretary Call** key that flashed.
4. Press the **Exit** key.

**To answer your Secretary Call indication:**

1. Place an Intercom call to the extension that called you.

**To cancel a Secretary Call you left at another extension:**

1. Press the lit **Secretary Call** key.

**To cancel a Secretary Call left at your extension:**

1. Do not lift the handset.
2. Press the flashing **Secretary Call** key.

## Description

This system supports the following built-in simple security features:

- ❑ **Warning Message (Watch Mode)**  
Automatically and periodically send the Watching (VRS) Message from built-In Speaker on Multiline Terminal or external paging adapter during nightmode.  
Enable to accommodate with 3rd Party PIR (Passive Infrared Sensor) or Emergency Button to provide security feature such as Auto-Emergency Call with Warning (VRS) Message sending.
- ❑ **Remote Inspection**  
Automatically ring the terminal with preprogrammed schedule in order to check whether users answer or not. If not answered, Emergency Call is placed to predefined destination automatically.

## Conditions

### Warning Message (Watch Mode)

- Watch mode can provide **Watching message** in a preprogrammed interval via internal paging group terminals during defined schedule such as night time.
- When connected to the system the security sensor will receive sensor detections and send a prepared warning message or emergency call to a preprogrammed destination.
- When connecting security sensor, set Program 20-46-01 Sensor mode to **1** (On), the security sensor can be connected to the detector circuit on the 2PGDAD. A maximum of eight sensors can be connected.
  - ❑ Applied voltage when sensor is Off: 5V
  - ❑ Loop current when sensor is On: 14mA
- When the system receives a detection signal from a contact on the 2PGDAD detector circuit. The input circuit contact setting in Program 20-46-12 must match the circuit setting in Program 10-41-01.
- Watch mode can be started and stopped automatically using settings in Program 20-47-01.
- Watch mode can be started and stopped manually using Service code (Program 11-12-63) or function key (SC752: \*32) assignment. After 10 seconds a warning message is provided, press again to stop the message.
- Security sensor can be started and stopped automatically using settings in Program 20-48-01.
- Security sensor can start and stop manually using Service code (Program 11-12-64) or function key (SC752: \*33). Function key (\*33) blinks until the timer in Program 20-55-01 expires, then the function key turns red. The system can detect a signal from the sensor.

- The Watching Message:
  - Is displayed after the timer in Program 20-44-04 expires.
  - Can be edited using the Service Code in Program 11-10-20.
  - Can be recorded up to a maximum of two minutes.
  - The Length of the watch message depends on the length of the recorded VRS message.
  - Internal Paging will only play the message when the targeted terminal is in an **Idle** state.
  - If an ordinary Internal Paging message is sent, the message is aborted and the watching message is played.
  - A Warning message has a higher priority than a Watch message when both occur at same time.
  - When using an external speaker, start and end tones are not supported.
- When the security sensor detects a signal the following options can be set:
  - A Warning message is sent.
  - An Emergency call is sent.
  - A Warning message and an Emergency call are both sent.
- Calling to an emergency destination:
  - The emergency number is set in Program 20-46-05.
  - Outside call routing uses Program 13-05-01.
  - If Program 13-05-01 is set to 0, outside call routing uses the settings in Program 14-06-01 and search for data from route table 100 using order 4 in descending order. If Program 14-06-01 is set to 0, outside calls are not supported.
  - If an outgoing call is set in a system, emergency calls cannot go through. When using outgoing call restriction, Class 1 toll restriction is followed.
  - If all trunks are busy, the emergency call is not sent. If this occurs, Alarm Type 33 is used.
- When an emergency call is answered:
  - Provide a VRS message to the destination.
  - After finishing the VRS message, start monitor operation which preprogrammed in Program 20-46-10. Also by pressing \* key from outside, it is possible to enable a two-way path. If the monitor terminal is not idle status, an emergency call destination cannot start monitor and hear no tone.
  - If a Watch or Warning message is sent to the destination and all VSR channels are busy, a tone is played instead of displaying the VRS message.
  - If the VRS message is not recorded, a tone is played.
  - Barge-in is not allowed to outside call while monitoring.
- A VRS message can be played from the extension's speaker only when the extension is idle. But if a Watch or Warning message is requested while a normal page is being used, normal paging stops and the Watch or Warning message is sent.

- If a warning tone is provided instead of the VRS message, paging information is displayed as a blank to the paging group terminal LCD.
- If a Watch or Warning message happens during normal paging, normal paging stops and the Watch or Warning message is sent.
- A Warning message has a higher priority than a Watch message when both occur at same time.
- Activating or stopping sensor operations need to be set according to sensor specifications.
- If an outgoing call restriction is set in a system, the number for the emergency call needs to be pre-registered in the restriction allow table.
- Auto outgoing call via leased line cannot go through when all trunks are busy.
- When an emergency call destination is not answered, the system repeats the emergency call the number of times specified in Program 20-46-08.
- For Answer detection of Analog Trunks;
  - In case of answer supervision, when answer supervision is received, the system recognizes the called party has answered.
  - In case of no answer supervision, after the inter digit timer has expired, the DTMF receiver waits for the \* key to be pressed. Then the system recognizes the called party has answered.
- During remote monitoring, the outside lines cannot be disconnected until the timer in Program 20-21-05 expires.
- For the Warning message:
  - Watch mode operation uses the order set in internal paging.
  - The VRS message can be edited using Service code Program 11-10-20.
  - The maximum length of a recorded message is two minutes.
  - If multiple sensors are detected at the same time, the latest detected sensor's Warning message is provided.
  - The warning message continues to play the same VRS message.
  - To cancel the Warning message use Security Sensor Reset Service Code Program 11-12-62.
  - When using external speaker, a start and end tone is not provided for any situation.
- If, while playing a Warning message and the targeted internal or external paging group was already playing another Warning message, the first Warning message is canceled. In this case either the internal or external paging group was duplicated with the latest paging group. An old Warning message stops both internal and external paging.
- If the DND key is pressed at the called terminal while playing a Watch or Warning message, the next message is not played because the terminal is determined to be busy. When the terminal returns to an idle state, the message is played again.
- An emergency call via analog trunk which has no disconnect signal, if Program 14-02-18 is invalid the call cannot disconnect by trunk side.

- In case of an emergency call the trunk key status is red. It is also red while monitoring or speaking.
- An emergency call goes through even if no trunk key is assigned to the terminal.
- In case of using internal and external paging group same time, message will provided when both paging groups are in idle status. If internal or external paging group is already used, message will not provided.
- In case of speaking status after monitor mode, monitored terminal key does not operate except speaker key.
- When the sensor malfunctions, use Security Sensor Reset Service Code programmed at Program 11-12-62 to cancel the operation, stop warning message or stop emergency call.
- During the Watch mode or Security sensor “On” state, if a system reset occurs these modes automatically continue after boot up.
- When sending a **Warning message** or placing an emergency call, if system reset occurs the call state is cleared. Following a boot up, the **Warning message** or source placing an emergency call will stop.
- If security sensor detects a signal, display below sentence to terminal which set Program 20-08-23 data to 1.

Figure 2-76 Idle Terminal Display

```

Clock/Calendar
Sensor Detect
List  Dir  ICM  Prog
1234567890123456789012345678

```

Press **Exit**, terminal returns to idle display.

- With Version 4000 or higher software, Mobile Extension can start or stop the Watch Mode automatically or by manually dialing the service code.
- With Version 4000 or higher software, Security Sensor Reset can be set automatically or by manually dialing the service code.
- With Version 4000 or higher software, Security Sensor Mode Start can be started or stopped automatically or by manually dialing the service code.

### Remote Inspection

- To use the Remote Inspection feature target destination setting is necessary.
- When Remote Inspection is set to the terminal, **Confirm** and **Ring Time** are displayed on Multiline Terminal LCD.

Figure 2-77 Confirm Ring Time Display

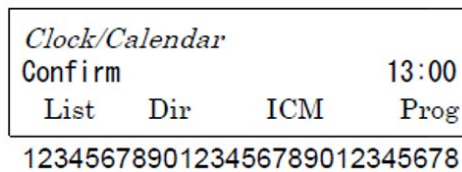

- If Remote Inspection set terminal is busy (receiving another incoming call or on active calls), an inspection ring starts after finishing the previous call.
- If the VRS message is not recorded, a warning tone instead of a VRS message is sent.
- A target dial can be programmed by using Service Code (Program 11-10-49).
- Outside call routing follows the settings in Program 13-05-1 Abbreviated Dialing.
- When Program 13-05-01 set to 0, an outside call route is referring to Program 14-06-01 setting and search data from route table 100 of order 4 in descending order. If Program 14-06-01 set to 0, no outside call is provided.
- If outgoing call restriction is set in a system, an emergency call cannot go through. In case of using outgoing call restrictions, toll restriction Class 1 is followed.
- Auto outgoing call via leased line cannot go through when all trunks are busy.
- When trunks are all busy, the emergency call does not complete. In this case, Alarm Type 33 is provided.
- When the target destination answered:
  - Provide a VRS message to the destination.
  - After finishing VRS message, destination person can start monitoring of inspection terminal. Also by dialing \* from outside it is possible to make both way talk. Dialing \* during the message will just stop the message from being played and then you must dial \* again to have speech path in both direction. When using Analog trunks the destination person must dial \* before the initial message is played to the caller.
  - Barge-in is not allowed to outside call while monitoring.
- If the destination does not answer an emergency call, the system repeats placing the call using the number of times set in Program 20-45-07.

- For answer detection of analog trunks:
  - In case of answer supervision, when answer supervision is received, the system recognizes the called party has answered.
  - In case of no answer supervision, after the inter digit timer has expired, the DTMF receiver waits for the \* key to be pressed. Then the system recognizes the called party has answered.
- An emergency call via analog trunk has no disconnect signal. If Program 14-02-18 is invalid the call cannot be disconnected on the trunk side.
- If the cable was disconnected while ringing, the ring does not restart once the cable is reconnected.
- In case of an emergency call trunk key status is red. It is also red while monitoring or speaking.
- An emergency call goes through even if no trunk key is assigned to the terminal.
- If the cable is disconnected while ringing, an emergency call performance is same as off-hook status. If the cable was not connected by ring timer, Program 20-01-19 is set to 1 provide an emergency call, set to 0 retry to ring the inspection terminal.
- If internal paging access performed while ringing, continues remote inspection ringing.
- In case of speaking status after monitor mode, monitored terminal key does not operate except speaker key.
- When disconnected from outside while monitoring, the line can not be released without disconnecting the signal. It disconnects when the timer in Program 20-21-05 ends. A disconnect also occurs while monitoring or speaking if the timer expires. To prevent a line hold, a disconnect occurs if the timer in Program 20-21-05 ends while hearing an answer message.
- A maximum of six extensions can be set as Remote Inspection terminals.
- If all VRS channels are busy, a tone is provided instead of the VRS message, such as an inspection message or a destination message.
- If the VRS message is not recorded, a tone is provided.
- ◇ *Emergency call destination must be set considering this feature's purpose.*
- The emergency number dialed does not follow ARS settings:
  - If Program 13-01-01 is set to Trunk the system uses command Program 13-05 to route the emergency call.
  - If Program 13-01-01 is set to ICM the system uses command Program 14-06 to route the emergency call.



- If remote inspection target does not answer, display below sentence to terminal which set Program 20-08-24 data to 1.

Figure 2-78 No Answer Display

```

Clock/Calendar
Remote Inspection No Answer
List Dir ICM Prog
1234567890123456789012345678
    
```

Press **Exit**, display returns to idle.

### Emergency Call 1

Emergency calls when **Security Sensor** or **Remote Inspection** performed, SMDR can record these call class as follows:

- Security Sensor: SAD
- Remote Inspection: WAD

### Emergency Call 2

When **Security Sensor** or **Remote Inspection** performs an Emergency call, alarm reports are recorded and the alarm display terminal indicates the following:

- Security Sensor: 31: Sensor Detect
- Remote Inspection: 32: Confirm Dial

### Recording Emergency Call

By setting Program 90-20-11 (1; Report) Emergency calls can be recorded on security report.

- Maximum of 50 records can be saved.

### Default Settings

None

## System Availability

### Terminals

All Multiline Terminals

## Required Component(s)

- GCD-8DLCA/ GCD-16DLCA
- PGDAD

## Related Features

- ➔ **Paging, External**
- ➔ **Speed Dial – System/Group/Station**
- ➔ **Voice Response System (VRS)**

## Guide to Feature Programming

The **Level 1**, **Level 2** and **Level 3** columns indicate the programs that are assigned when programming this feature in the order they are most commonly used. These levels are used with PCPro and WebPro wizards for feature programming.

- Level 1 – these are the most commonly assigned programs for this feature.
- Level 2 – these are the next most commonly assigned programs for this feature.
- Level 3 – these programs are not often assigned and require an expert level working knowledge of the system to be properly assigned.

Program Number	Program Name/Description	Input Data	Default	Level		
				1	2	3
11-10-46	<b>Service Code Setup (for System Administrator) – Watch Message Setting</b> Service Code setting for Watching message recording to VRS.	MLT, SLT 0 ~ 9, *, # Maximum of eight digits	614(NA/AT)/ 714(OT)		✓	
11-10-47	<b>Service Code Setup (for System Administrator) – Warning Message Setting</b> Service Code setting for Warning message recording to VRS.	MLT, SLT 0 ~ 9, *, # Maximum of eight digits	615(NA/AT)/ 719(OT)		✓	
11-10-48	<b>Service Code Setup (for System Administrator) – Auto Dial for Security Sensor</b> Service Code setting for destination number when Warning mode detected.	MLT 0 ~ 9, *, # Maximum of eight digits	617(NA/AT)/ 748(OT)		✓	
11-10-49	<b>Service Code Setup (for System Administrator) – Auto Dial for Remote Inspection</b> Service Code setting for destination number when remote inspection detects no answer.	MLT 0 ~ 9, *, # Maximum of eight digits	619(NA/AT)/ 749(OT)		✓	

Program Number	Program Name/Description	Input Data	Default	Level		
				1	2	3
11-12-62	<b>Service Code Setup (for Service Access) – Security Sensor Reset</b> Service Code setting for cancel Warning message sending and emergency call.	MLT, SLT 0 ~ 9, *, # Maximum of eight digits	716(NA/AT)/ 837(OT)		✓	
11-12-63	<b>Service Code Setup (for Service Access) – Watch Mode Start</b> Service Code (SC) setting for on/off watch mode. SC+1; Watch mode start SC+0; Watch mode end.	MLT, SLT 0 ~ 9, *, # Maximum of eight digits	717(NA/AT)/ 817(OT)		✓	
11-12-64	<b>Service Code Setup (for Service Access) – Security Sensor Mode Start</b> Service code + 1, after the timer (Program 20-55-01) passes, sensor signal is valid. Service code + 0, sensor signal is invalid.	MLT, SLT 0 ~ 9, *, # Maximum of eight digits	719(NA/AT)/ 819(OT)		✓	
13-04-01	<b>Speed Dialing Number and Name – Speed Dialing Data</b> Enter the System and Group Speed Dialing numbers and names.	Maximum of 24 digits. 1 ~ 9, 0, *, # Pause (Press line key 1) Recall/Flash (Press line key 2) @ = Code to wait for answer supervision in ISDN (Press line key 3)	No Setting	✓		
15-07-01	<b>Programmable Function Keys</b> Assign a function key for Warning Message (code *32).	Line Key 1 ~ 48 0 ~ 99 (Normal Function Code 751 by default) *00 ~ *99 (Appearance Function Code) (Service Code 752 by default)	Refer to the Programming Manual for default values.	✓		
15-07-01	<b>Programmable Function Keys</b> Assign a function key for Sensor Mode (code *33).	Line Key 1 ~ 48 0 ~ 99 (Normal Function Code 751 by default) *00 ~ *99 (Appearance Function Code) (Service Code 752 by default)	Refer to the Programming Manual for default values.	✓		
20-01-19	<b>System Options – Emergency Call Setting of Remote Inspection Feature when the Target is in Off-Hook Status</b> Assign to make an emergency call when the inspection target is in off hook status.	0 = Not Call 1 = Call	0		✓	
20-08-23	<b>Class of Service Options (Outgoing Call Service) – Display Indication for Security Sensor Detection</b> Enable(1) or Disable(0) an extension's ability to display indication for security sensor detection.	0 = Disable 1 = Enable	0		✓	
20-08-24	<b>Class of Service Options (Outgoing Call Service) – Display Indication for Emergency Call by Remote Inspection</b> Enable(1) or Disable(0) an extension's ability to display indication for emergency call by remote inspection.	0 = Disable 1 = Enable	0		✓	

Program Number	Program Name/Description	Input Data	Default	Level		
				1	2	3
20-21-05	<b>System Option when Long Conversation – Conversation Cutoff for Remote Monitor</b>	0 ~ 64800 seconds	180			✓
20-44-01	<b>Watch Mode Setup – Internal Paging Group for Watch Message</b> Define Internal paging group number for Watching message.	0 = No Internal Paging 1 ~ 64 = Internal Paging Group Number	0	✓		
20-44-02	<b>Watch Mode Setup – External Paging Group for Watch Message</b> Define External paging group number for Watching message.	0 = No External Paging 1 ~ 8 = External Paging Group Number	0	✓		
20-44-03	<b>Watch Mode Setup – VRS Message for Watch Mode</b> Define VRS number used for Watching message.	0 = Send Warning Tone 1 ~ 100 = VRS Message Number	0	✓		
20-44-04	<b>Watch Mode Setup – Interval Timer for Watch Message</b> Define interval time for sending Watching message.	0 = No Message Send 1 ~ 60 (minutes)	0	✓		
20-45-01	<b>Remote Watch Setup – Ring Terminal for Remote Monitor</b> Assign Extension number for Remote Inspection.	Terminal No. 1 ~ 6: Extension Number (maximum of eight digits)	No Setting	✓		
20-45-02	<b>Remote Watch Setup – Ring Time Setting</b> Assign Ringing start time for Inspected Extension.	Terminal No. 1 ~ 6: 0000 ~ 2359	0000	✓		
20-45-03	<b>Remote Watch Setup – Ring Timer</b> Assign Ringing continue time for inspected extension.	Terminal No. 1 ~ 6: 0 ~ 60	0	✓		
20-45-04	<b>Remote Watch Setup – Auto Dial Number Area Setting</b> Assign Speed dial area number when detect no answer at extension and make emergency call.	Terminal No. 1 ~ 6: Speed Dial Area 0 ~ 1999	0	✓		
20-45-05	<b>Remote Watch Setup – VRS Message for Answer</b> Assign VRS message number when inspected extension answered.	Terminal No. 1 ~ 6: 0 = Send Warning Tone 1 ~ 100 = VRS Message	0	✓		
20-45-06	<b>Remote Watch Setup – VRS Message for Autodial</b> Assign VRS message number when emergency call destination answered.	Terminal No. 1 ~ 6: 0 = Send Warning Tone 1 ~ 100 = VRS Message Number	0	✓		
20-45-07	<b>Remote Watch Setup – Time of Repeat Autodial</b> Assign Repeat numbers for making emergency call.	Terminal No. 1 ~ 6: 0 = No Redial 1 ~ 255 (times)	0	✓		

Program Number	Program Name/Description	Input Data	Default	Level		
				1	2	3
20-45-08	<b>Remote Watch Setup – Auto Dial Calling Time</b> Assign Calling continue time when making emergency call.	Terminal No. 1 ~ 6: 0 = No Redial 1 ~ 3600 (seconds)	0	✓		
20-45-09	<b>Remote Watch Setup – Interval of Auto Dial</b> Assign interval between Auto Dial when making emergency call.	Terminal No. 1 ~ 6: 0 = No Call 1 ~ 3600 (seconds)	0		✓	
20-46-01	<b>Security Sensor Setup – Sensor Mode</b> Define to use security sensor.	Security Sensor No. 1 ~ 8 0 = Disable 1 = Enable	0	✓		
20-46-02	<b>Security Sensor Setup – Internal Paging Group for Warning Message</b> Define Internal paging group number for Warning message.	Security Sensor No. 1 ~ 8 0 = No Internal Paging 1 ~ 64 = Internal Paging Group Number	0	✓		
20-46-03	<b>Security Sensor Setup – External Paging Group for Warning Message</b> Define External paging group number for Warning message.	Security Sensor No. 1 ~ 8 0 = No External Paging 1 ~ 8 = External Paging Group Number	0		✓	
20-46-04	<b>Security Sensor Setup – VRS Message for Warning</b> Define VRS number used for Warning message.	Security Sensor No. 1 ~ 8 0 = Send Warning Tone 1 ~ 100 = VRS Message Number	0	✓		
20-46-05	<b>Security Sensor Setup – Auto Dial Number Area Setting</b> Define Speed dial area number when sensor detects warning.	Security Sensor No. 1 ~ 8 Speed Dial Area 0 ~ 1999	1999	✓		
20-46-06	<b>Security Sensor Setup – VRS Message for Answer</b> Define VRS message number when emergency call destination answered.	Security Sensor No. 1 ~ 8 0 = Send Warning Tone 1 ~ 100 = VRS Message Number	0	✓		
20-46-07	<b>Security Sensor Setup – Auto Dial Wait Timer</b> Define wait time before making emergency auto dial.	Security Sensor No. 1 ~ 8 0 = Immediate Call 1 ~ 64800 seconds	10	✓		
20-46-08	<b>Security Sensor Setup – Repeat Dial Times</b> Define repeat numbers for making emergency call.	Security Sensor No. 1 ~ 8 0 = No Redial 1 ~ 255 (times)	0	✓		

Program Number	Program Name/Description	Input Data	Default	Level		
				1	2	3
20-46-09	<b>Security Sensor Setup – Auto Dial Calling Time</b> Define calling continue time when making emergency call.	Security Sensor No. 1 ~ 8 0 = No Call 1 ~ 3600 seconds	120	✓		
20-46-10	<b>Security Sensor Setup – Monitored Terminal</b> Define extension number for monitor from outside. IP terminal cannot set as monitored extension.	Security Sensor No. 1 ~ 8 Extension Number (maximum of eight digits)	No Setting	✓		
20-46-11	<b>Security Sensor Setup – Interval of Auto Dial</b> Assign interval between Auto Dial when making emergency call.	Security Sensor No. 1 ~ 8 0 = No Call 1 ~ 3600 seconds	0	✓		
20-46-12	<b>Security Sensor Setup – General Purpose Relay Contact Detector Circuit Setup</b> Define general purpose relay contact detector circuit number (programmed in Program 10-41) for connect security sensor.	Security Sensor No. 1 ~ 8 0 = Not Used 1 ~ 8 = Detect Circuit Number	0	✓		
20-47-01	<b>Time Pattern Setting for Watch Mode – Watch Mode</b> Define watch mode on/off against time pattern 1 ~ 8.	Time Pattern 1 ~ 8: 0 =Off 1 = On	0		✓	
20-48-01	<b>Time Pattern for Security Sensor – Security Sensor</b> Define security sensor on/off against time pattern 1 ~ 8.	Time Pattern 1 ~ 8: 0 =Off 1 = On	0		✓	
20-55-01	<b>Delay Timer for Security Sensor – Sensor Delay Timer</b> Assign the delay time, when the contact detection start to work after set the security sensor. The sensor starts at once in case of set 0.	0 ~ 3600 seconds	60		✓	
35-02-22	<b>SMDR Output Options – Security Auto Dialing</b> Select whether the system should display the SAD (Security Auto Dialing) on SMDR report.	0 = No Output 1 = Output	0		✓	
35-02-23	<b>SMDR Output Options – Watch Auto Dialing</b> Select whether the system should display the WAD (Warning Auto Dialing) on SMDR report.	0 = No Output 1 = Output	0			✓
90-10-01	<b>System Alarm Setup – Alarm Type</b> Set the alarm type 31, 32, 33. Alarm 31 – Auto dialing after sensor detection. Alarm 32 – Auto Dialing for Remote Watch function. Alarm 33 – Fail to auto dialing of security function.	0 = Not Set 1 = Major Alarm 2 = Minor Alarm	0		✓	

Program Number	Program Name/Description	Input Data	Default	Level		
				1	2	3
90-10-02	<b>System Alarm Setup – Report</b> Assign whether or not the alarm information is reported to the predefined destination in Program 90-11.	0 = No Report (no autodial) 1 = Report (autodial)	0		✓	
90-20-11	<b>Traffic Report Data Setup – Security Sensor Dial Record</b> Assign whether or not the security sensor dial report is recorded for Record Security sensor dialing and Remote Inspection dialing.	0 = Not Record 1 = Record	0			✓

## Operation

### Warning Message (Watch Mode)

< Program >

Program 11-10-20: (616) Record, Erase VRS message SC616

Program 11-10-46: (614) Watch message setting

Program 11-12-63: (717+1/0) Watch Mode Start/Stop

Program 15-07-01: Set \* 32 to Function key

Program 20-44-01: (1) Internal paging group, 1

Program 20-44-02: (1) External paging group, 1

Program 20-44-03: (1) VRS message number for watching, 1

Program 20-44-04: (5) Interval time of Watching message, 5 minutes

Program 20-47-01: (1) Watch mode time pattern, 1

#### To record Watching message to VRS 001:

1. Press **Speaker** and dial **616 + 7 + 001**.
2. After the beep, record message.
3. Press **Speaker** to hang up.

#### Set up Watch mode:

1. Press **Speaker** and dial **614**.
2. Dial the internal paging group number **01**.
3. Dial the external paging group number **1**.
4. Dial the interval time of Watch message **05**.
5. Dial the VRS message number being watched **001**.
6. After the beep, record message.

7. Press **Speaker** to hang up.

#### To Start Watch mode:

1. Press **Speaker** and dial **717 + 1**.  
**-OR-**  
 Press function key (**\*32**), the function keys turn red.  
**-OR-**  
 Wait for Watch mode pattern 1 to start.
2. The Watching message is sent to internal and external page group 1 (every five minutes).

#### To Stop Watch mode:

1. Press **Speaker** and dial **717 + 0**.  
**-OR-**  
 Press the red lit function key (**\*32**), the function keys turn off.  
**-OR-**  
 Wait for Watch mode pattern 1 to end.

#### Warning Message (Use Security Sensor and Warning Message)

< Program >

Program 10-41-01(Index 1): (2) Slot Number connected with 2PGDAD  
 Program 10-41-02(Index 1): (8) Port Number connected with 2PGDAD  
 Program 10-41-03(Index 1): (1) Detection circuit number on 2PGDAD where a Sensor is connected to  
 Program 11-10-47: (615) Warning message setting  
 Program 11-10-48: (617) Auto Dial Setting for Security Sensor  
 Program 11-12-62: (716) Security Sensor Reset  
 Program 11-12-64: (719+1/0) Security Sensor Mode Start/Stop  
 Program 15-07-01: Set \* 33 to Function key  
 Program 20-46-01: (1) Sensor mode, on  
 Program 20-46-02: (1) Internal paging group, 1  
 Program 20-46-03: (1) External paging group, 1  
 Program 20-46-04: (1) VRS message number for warning, 1  
 Program 20-46-05: (1999) Speed dial bin number, 1999  
 Program 20-46-06: (2) VRS message number for destination answer, 2  
 Program 20-46-07: (10) Auto Dial Wait Timer, 30 sec  
 Program 20-46-08: (3) Times of auto repeat dial, 3  
 Program 20-46-09: (30) Auto dial calling time, 30 sec  
 Program 20-46-10: (200) Monitored terminal number, 200  
 Program 20-46-11: (30) Interval of Auto Dial, 30 sec  
 Program 20-46-12: (1) General purpose relay contact detector circuit 1  
 Program 20-48-01: (1) Security sensor time pattern, 1  
 Program 20-55-01: (60 sec, default) Sensor delay timer



**Set up Warning message:**

1. Press **Speaker** and dial **615**.
2. Dial the Security sensor number **1**.
3. Dial the Internal paging group number, **01**.
4. Dial the external paging group number, **1**.
5. Dial the VRS message number for the warning, **001**.
6. After the beep, record message.
7. Press **Speaker** to hang up.

**Set up Auto Dial (Security Sensor) Using Service Code:**

1. Press **Speaker** and dial **617**.
2. Dial the Security sensor number (1~8), **1**.
3. Dial the Speed dial bin number to be used, **1999**.
4. Dial the emergency call destination number xxx-xxx and press **Hold**.
5. Dial the monitored terminal number, **200**.
6. Dial the VRS message number **002**.
7. After the beep, record message.
8. Press **Speaker** to hang up.

**Start Security Operation:**

1. Press **Speaker** and dial **719 + 1**. The sensor is enabled using the timer in Program 20-55-01.  
**-OR-**
2. Press function key (**\*33**), the function keys turn red. The key lights after the timer in Program 20-55-01 expires. The sensor is valid.  
**-OR-**
3. Security Sensor time pattern 1 starts.

**Stop Security Operation:**

1. Press **Speaker** and dial **719 + 0**.  
**-OR-**
2. Press the red lit function key (**\*33**), the function keys turn off.
3. Security Sensor time pattern 1 stops.

### When Detect Security Sensor is On:

1. A Warning message sent to internal page group 1 and external page group 1.
2. An outgoing call is automatically sent according to setting in speed dial bin 1999.
3. When destination answers, VRS sends a second message.
4. Once received, extension 200 can be used for monitoring. To have a two-way conversation, dial \*.

### To Send Warning message:

To send a Warning message, but not as an Emergency call:

Change Program 20-46-05 to **no setting**.

### To Place an Emergency Call:

To send an Emergency call, but not as a Warning message:

Set Programs 20-46-02 and 20-46-03 to **0**.

## Remote Inspection

<Program>

Program 11-10-49: (619) Auto Dial Setting for Remote

Program 20-45-01: (200) Remote Inspection terminal, 200

Program 20-45-02: (12:00) Ringing start time, 12 o'clock noon

Program 20-45-03: (3) ringing continue time, 3 minutes

Program 20-45-04: (1999) Speed dial bin number, 1999

Program 20-45-05: (1) VRS message number when inspected extension answered, 1

Program 20-45-06: (2) VRS message number when emergency call destination answered, 2

Program 20-45-07: (3) Times of auto repeat dial, 3

Program 20-45-08: (30) Auto dial calling time, 30 sec

Program 20-45-09: (30) Interval of Auto Dial, 30 sec

### Set Up Remote Inspection:

1. Press **Speaker** and dial **619**.
2. Dial the Remote Inspection terminal number (1-6).
3. Dial **1** to set.
4. Dial the Remote Inspection extension number, **200**.
5. Dial the Ring start time, **1200**.
6. Dial ring length time, **03**.
7. Dial the Speed dial bin number to be used, **1999**.

8. Dial the emergency call destination number xxx-xxx and press **Hold**.
9. When answered, dial the VRS message number **001**.
10. After the beep, record the message and press **#**.
11. When the emergency call destination answers, dial VRS message2
12. After confirmation tone, record message.
13. Press **Speaker** to hang up.

**Cancel the Remote Inspection:**

1. Press **Speaker** and **619**.
2. Dial the Remote Inspection number (1~6).
3. Dial **0** to cancel.

**Answering the Remote Inspection Ring:**

1. At 12:00 o'clock (noon) extension 200 starts ringing.
2. The first VRS message plays when answered.
3. When message finishes, the call disconnects.

**Not Answering the Remote Inspection Ring**

1. At 12:00 o'clock extension 200 starts ringing.
2. Ringing continues for over three minutes.
3. The ringing on extension 200 ends and a call is automatically placed to Speed dial bin 1999.
4. When answered, VRS sends a second message.
5. After finishing second VRS message finishes, called destination can automatically monitor extension 200.
6. Press **\*** to enable two-way conversation.

**Emergency Call Record**

<Program Example>  
 Program 10-20-01 (Index 5): 10000  
 Program 14-01-06: 1  
 Program 35-01-01: 3 (LAN)  
 Program 35-02-22: 1  
 Program 35-02-23: 1

◇ *In above setting, make sensor mode or remote inspection emergency call, record to SMDR.*

## Alarm Report

<Program Example>

Program 90-10-02 (Index 31, 32, 33): (1) report

Program 90-50-01: Extension number for System Alarm Display Telephone

In the above settings, send an alarm display to the terminal preprogrammed in Program 90-50-01 and report to the predefined destination in Program 90-11.

After Program 90-53-01 completes, alarm display is cancelled.

## Security Report

<Program Example>

Program 10-20-01 (Index 12): 20000

Program 90-20-11: 1

◇ *In the above settings, use the sensor mode or remote inspection emergency call, to record a traffic report.*

## Selectable Display Messaging

### Description

An extension user can select a programmed Selectable Display Message for their extension. Display multiline terminal callers see the selected message when they call the user’s extension. Selectable Display Messaging provides personalized messaging. For example, an extension user could select the message GONE FOR THE DAY. Any display multiline terminal user calling the extension may hear a DND signal and then see the message. See table below for a list of the standard messages.

An extension user can add digits for date, time or telephone number after messages 1~8 and 10 (up to 24 characters). For example, an extension user could select the message ON VACATION UNTIL and then enter the date. Callers see the original message followed by the appended date. They could then tell when the user is coming back from vacation. The system allows all telephones to use the Selectable Display Messaging feature at the same time.

All telephones can use Selectable Display Messaging at one time.

The default messages are:

*Table 2-96 Selectable Display Messaging Defaults*

No.	Message	Change “#” to...
1	IN MEETING UNTIL ##:##	Time (when meeting done)
2	MEETING ROOM - #####	Room Name or extension
3	COME BACK ##:##	Time (when returning)
4	PLEASE CALL #####	11 digits (telephone number)
5	BUSY CALL AFTER ##:##	Time (when returning)
6	OUT FOR LUNCH BACK ##:##	Time (when returning)
7	BUSINESS TRIP BACK ##/##	Date (when returning)
8	BUSINESS TRIP #####	10 digits (where reached)
9	GONE FOR THE DAY	
10	ON VACATION UNTIL ##/##	Date (when returning)
11~20	MESSAGE 11~20	

### Conditions

- When setting a Selectable Display message that includes date or time inputs, no validation is given in the display.
- When Selectable Display Messaging is set as DND All, all other DND modes are canceled when Selectable Display Messaging is canceled.

- The Selectable Display Message will not display to the calling party's phone if there is forwarding on the phone that set the Selectable Display, it will just follow the forwarding.

### Default Settings

Enabled

## System Availability

### Terminals

All Multiline Terminals with Display

### Required Component(s)

None

## Related Features

- ➔ **Do Not Disturb**
- ➔ **Programmable Function Keys**

## Guide to Feature Programming

The **Level 1**, **Level 2** and **Level 3** columns indicate the programs that are assigned when programming this feature in the order they are most commonly used. These levels are used with PCPro and WebPro wizards for feature programming.

- Level 1 – these are the most commonly assigned programs for this feature.
- Level 2 – these are the next most commonly assigned programs for this feature.
- Level 3 – these programs are not often assigned and require an expert level working knowledge of the system to be properly assigned.

Program Number	Program Name/Description	Input Data	Default	Level		
				1	2	3
11-11-14	<b>Service Code Setup (for Setup/Entry Operation) – Text Message Setting</b> Define the service code used when setting a text message.	MLT 0 ~ 9, *, # Maximum of eight digits	No Setting	✓		

Program Number	Program Name/Description	Input Data	Default	Level		
				1	2	3
15-07-01	<b>Programmable Function Keys</b> Assign a function key for Text Message (code 18). The Text Message key automatically selects the message used when programming the key.	Line Key 1 ~ 48 0 ~ 99 (Normal Function Code 751 by default) *00 ~ *99 (Appearance Function Code) (Service Code 752 by default)	Refer to the Programming Manual for default values.	✓		
20-01-02	<b>System Options – Text Message Mode</b> Select whether an intercom caller should hear busy (1) or ring through (0) for extensions which have Selectable Display Messaging set. ➡ Any extension previously set with Selectable Display Messaging must cancel the feature and reactivate for a change in this option to take affect.	0 = Call mode 1 = No Answer/Busy mode	1		✓	
20-02-07	<b>System Options for Multiline Telephones – Time and Date Display Mode</b> Set the System Time and Date display mode. The time that displays in Selectable Display Messages follows this setting.	1 ~ 8 Type 1 = (12 hour) 10 MAR TUE 3:15PM Type 2 = (12 hour) 3:15PM MAR 10 TUE Type 3 = (12 hour) 3-10 TUE 3:15 PM Type 4 = (12 hour) 3:15PM TUE 10 MAR Type 5 = (24 hour) 10 MAR TUE 15:15 Type 6 = (24 hour) 15:15 MAR 10 TUE Type 7 = (24 hour) 3-10 TUE 15:15 Type 8 = (24 hour) 15:15 TUE 10 MAR	3		✓	
20-06-01	<b>Class of Service for Extensions</b> Assign a Class of Service (1 ~ 15) to an extension.	Day Night/Mode: 1 ~ 8 Class of Service of Extensions (1 ~ 15)	Extension port 101 = Class 15 All other extension port = Class 1		✓	
20-13-19	<b>Class of Service Options (Supplementary Service) – Selectable Display Messaging (Text Messaging)</b> Turn Off or On an extension user ability to use Selectable Display Messaging.	0 = Off 1 = On	COS 1 ~ 15 = 1		✓	
20-16-01	<b>Selectable Display Messages</b> Program the Selectable Display Messages (1 ~ 20). Refer to the chart below for character entry.	Maximum of 24 characters.	Refer to <a href="#">Table 2-96 Selectable Display Messaging Defaults on page 2-1417</a>		✓	

Table 2-97 Selectable Display Message – Character Entry Chart

Use this keypad digit . . .	When you want to . . .
1	Enter characters: 1 @ [ ¥ ] ^ _ ‘ {   } > <
2	Enter characters: <b>A-C, a-c, 2.</b>
3	Enter characters: <b>D-F, a-f, 3.</b>
4	Enter characters: <b>G-I, g-i, 4.</b>
5	Enter characters: <b>J-L, j-l, 5.</b>
6	Enter characters: <b>M-O, m-o, 6.</b>
7	Enter characters: <b>P-S, p-s, 7.</b>
8	Enter characters: <b>T-V, t-v, 8.</b>
9	Enter characters: <b>W-Z, w-z, 9.</b>
0	Enter characters: 0 ! “ # \$ % & <space> ( )
*	Enter characters: * + , - . / : ; < = > ?
#	<b>Accepts a numeric entry from the user when setting a display message. e.g., time or date. Back at ##:##</b>
<b>Feature</b>	Clear the character entry one character at a time (when using service code or function key).
<b>Recall</b>	Clear the character entry one character at a time (when in telpro).
<b>HOLD (Telpro only)</b>	Clear all the entries from the point of the flashing cursor and to the right.

## Operation

### To select a message:

1. Press **Speaker** + press the **Text Message** key (Program 15-07 or SC 751: 18) + enter digits to append (if needed) + **Speaker** to hang up. Skip the remaining steps.
2. (Optional for messages 1~8 and 10.)  
Dial the digits you want to append to the message.
  - ◇ *You can append messages 1~8 and 10 with digits (e.g., the time when you will be back). Enter the time in 24-hour format.*



3. Press **Speaker** to hang up.
  - ◇ *Intercom calls to extensions with Selectable Display Messaging set receive a DND signal and receive the display message on their telephone display instead of ringing the extension based on the setting in Program 20-01-02.*
  - ◇ *To allow calls to ring through and have the message displayed on the calling extension display, cancel DND by pressing DND feature key + 0.*

#### To cancel a message:

1. Press **Speaker** and the **Text Message** key (Program 15-07 or SC 751: 18).
2. Press **Speaker** to hang up.

#### Using the Text Message Service Code to select a message:

1. Press **Speaker** and dial the Text Message service code (Program 11-11-14).
2. Dial the Selectable Display Message number to be used (**01~20**).  
(Optional messages 1~8, and 10, dial the digits you want to append to the message.)
3. Press **Speaker** to hang up.
  - ◇ *To cancel, repeat Step 1 and hang up.*

## Selectable Ring Tones

### Description

An extension user can change the way trunks or internal calls ring their telephone. Selectable Ring Tones allow an extension user to set up unique ringing for their calls. This is important in a crowded work area where several telephones are close together. Because their telephone has a characteristic ring, the user always can tell when their telephone is ringing.

#### Conditions

None

#### Default Settings

Enabled

### System Availability

#### Terminals

All Multiline Terminals

#### Required Component(s)

None

### Related Features

➔ [Distinctive Ringing, Tones and Flash Patterns](#)

### Guide to Feature Programming

The **Level 1**, **Level 2** and **Level 3** columns indicate the programs that are assigned when programming this feature in the order they are most commonly used. These levels are used with PCPro and WebPro wizards for feature programming.

- Level 1 – these are the most commonly assigned programs for this feature.
- Level 2 – these are the next most commonly assigned programs for this feature.
- Level 3 – these programs are not often assigned and require an expert level working knowledge of the system to be properly assigned.

Program Number	Program Name/Description	Input Data	Default	Level		
				1	2	3
11-11-20	<p><b>Service Code Setup (for Setup/Entry Operation) – Change Incoming CO and ICM Ring Tones</b></p> <p>If required, change the service code used for changing the incoming ring tones heard for CO and ICM calls.</p>	<p>MLT 0 ~ 9, *, # Maximum of eight digits</p>	720		✓	
11-11-21	<p><b>Service Code Setup (for Setup/Entry Operation) – Check Incoming Ring Tones</b></p> <p>If required, change the service code used for checking how the incoming ring tones sound.</p>	<p>MLT 0 ~ 9, *, # Maximum of eight digits</p>	711		✓	
15-02-02	<p><b>MultiLine Telephone Basic Data Setup – Trunk Ring Tone</b></p> <p>Set the tone (pitch) of the incoming trunk ring for the extension port you are programming.</p>	<p>1 = High 2 = Medium 3 = Low 4 = Ring Tone 1 5 = Ring Tone 2 6 = Ring Tone 3 7 = Ring Tone 4 8 = Ring Tone 5</p>	2		✓	
15-02-03	<p><b>Multiline Telephone Basic Data Setup – Extension Ring Tone</b></p> <p>Set the tone (pitch) of the incoming extension call ring for the extension port you are programming. Also refer to program 15-08.</p>	<p>1 = High 2 = Medium 3 = Low 4 = Ring Tone 1 5 = Ring Tone 2 6 = Ring Tone 3 7 = Ring Tone 4 8 = Ring Tone 5</p>	8		✓	
15-08-01	<p><b>Incoming Virtual Extension Ring Tone Setup</b></p> <p>When an extension or a virtual extension is assigned to the function key on the key telephone, select the ring tone when receiving a call on that key.</p> <p>For CAR keys, only tone pattern 1 can be used. The remaining patterns are not checked with this feature.</p>	<p>ICM Tone Pattern, 0 = Pattern 1 1 = Pattern 2 2 = Pattern 3 3 = Pattern 4 4 = Incoming Ring Tone Extension 5 = Pattern 5 6 = Pattern 6 7 = Pattern 7 8 = Pattern 8</p>	0		✓	

Program Number	Program Name/Description	Input Data	Default	Level		
				1	2	3
15-10-01	<b>Incoming Virtual Extension Ring Tone Order Setup</b> When two or more virtual extensions are set on a function key on the telephone, and the tone pattern by which the sound of each extension differs, the priority of ring sound is set up.	0 = Tone Pattern 1 1 = Tone Pattern 2 2 = Tone Pattern 3 3 = Tone Pattern 4 4 = Incoming Extension Ring Tone 5 = Tone Pattern 5 6 = Tone Pattern 6 7 = Tone Pattern 7 8 = Tone Pattern 8	Priority order: 1 = 0 (Tone Pattern 1) 2 = 1 (Tone Pattern 2) 3 = 2 (Tone Pattern 3) 4 = 3 (Tone Pattern 4)		✓	
22-03-01	<b>Trunk Ring Tone Range</b> Select the ring tone range for the trunk. The trunk uses a ring tone in the range selected when it rings an extension. Eight ring tones are available.	0 ~ 12 (Ring Tone Pattern 1 ~ 4) (Melody 1 ~ Melody 5) (Ring Tone Pattern 5 ~ 8)	0		✓	

Table 2-98 Intercom or Trunk Ring Setting

<b>1 = High</b>	<b>5 = Ring Tone 2</b>
<b>2 = Mid Range</b>	<b>6 = Ring Tone 3</b>
<b>3 = Low</b>	<b>7 = Ring Tone 4</b>
<b>4 = Ring Tone 1</b>	<b>8 = Ring Tone 5</b>

## Operation

### To change your extension incoming ring tones:

1. Press **Speaker**.
2. Dial **720**.
3. Dial **1** to set Intercom ring; **2** to set trunk ring.
4. Dial code for the desired ring pattern (**1~8**).
5. Press **Speaker** to hang up.

### To listen to the incoming ring choices:

1. Press idle **Speaker**.
2. Dial **711**.

3. Dial **1** to listen to Intercom ring; **2** to listen to trunk ring.
4. *For Intercom Ring:*  
Dial the code for the ring pattern you want to hear (**1~8**).  
  
- OR -  
*For Trunk Ring:*  
Dial code for the ring pattern you want to hear (Ring 1~3, Melody 4~8). If you select Ring 1~3, a second screen prompts for the tone pattern (1~4).
5. Press **Speaker** to hang up.

## Serial Call

### Description

Serial Call transfers a call so it automatically returns to the transferring extension. Serial Calling saves transferring steps between users. For example, a Customer Service Representative (CSR) has a client on the telephone who needs technical advice. The CSR wants to send the call to Technical Service, but needs to advise the client of certain costs when Technical Service is done. Rather than transferring the call back and forth, the CSR can use Serial Call to Technical Service and announce, “I have Ted on the telephone. I need to talk to him again. Just hang up when you’re done and I’ll get him back.”

### Conditions

- The transferring extension can remain off-hook to auto-receive the callback or hang up and it rings back to them.
- Serial Call requires a uniquely programmed function key (Program 15-07 or SC 751: 43) or assigning the Transfer key as Call Back in (Program 15-02-05=1).
- Serial Call is not available to single line telephones.
- Serial Call can be activated only during a supervised transfer.

### Default Settings

Disabled

### System Availability

#### Terminals

All Multiline Terminals

#### Required Component(s)

None

### Related Features

➔ **Programmable Function Keys**

➔ **Transfer**

## Guide to Feature Programming

The **Level 1**, **Level 2** and **Level 3** columns indicate the programs that are assigned when programming this feature in the order they are most commonly used. These levels are used with PCPro and WebPro wizards for feature programming.

- Level 1 – these are the most commonly assigned programs for this feature.
- Level 2 – these are the next most commonly assigned programs for this feature.
- Level 3 – these programs are not often assigned and require an expert level working knowledge of the system to be properly assigned.

Program Number	Program Name/Description	Input Data	Default	Level		
				1	2	3
15-02-05	<b>Multiline Telephone Basic Data Setup – Transfer Key Operation Mode</b> Set the operating mode of the extension Transfer key. The keys can be for Call Transfer, Serial Calling or Flash. When selecting Flash (2), refer also to Program 81-01-14.	0 = Transfer 1 = Serial Call 2 = Flash	0		✓	
15-07-01	<b>Programmable Function Keys</b> Assign a programmable key as a Serial Call key (code 43).	Line Key 1 ~ 48 0 ~ 99 (Normal Function Code 751 by default) *00 ~ *99 (Appearance Function Code) (Service Code 752 by default)	Refer to the Programming Manual for default values.		✓	

## Operation

### To place a Serial Call to a co-worker:

1. Place or answer a call.
  2. Press **Hold** or **Transfer**.
  3. Dial co-worker’s extension number.
    - ◇ *Co-worker must lift the handset to respond to your announcement.*
  4. Press the Serial Call key (Program 15-07 or SC 751: 43).
- OR-**
5. Press **Transfer** key if Program 15-02-05 is set to Call Back (Serial Call).
  6. When the multiline terminal display shows WAIT TRF extension can hang up.
    - ◇ *When your co-worker hangs up the call, the system makes an automatic live transfer back to your extension.*

## Simple MCU Video

### Description

The Simple MCU Video feature provides a built in video conferencing MCU for up to four standard SIP phones using the Remote Conference feature of the SV9100 system.

The video functionality can also be set to use system VoIP DSP resources for non-MCU video conferencing if peer-to-peer calls between standard SIP phones is disabled or not supported by the terminal used. If the system is set to allow peer-to-peer calls between standard SIP stations then no system DSP resources are required to support the video functionality between standard SIP phones.

*Figure 2-79 Maximum of Four Standard SIP Phone Users*

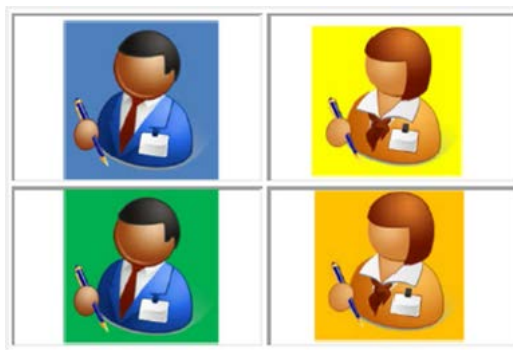

### Conditions

- CO calls cannot be transferred to a Remote Conference pilot and must be directed to the conference pilot as a DID or DIL termination.
- If peer-to-peer is disabled the standard SIP video feature requires VoIP DSP resource be reserved for this function reducing the number of VoIP resources available for SIP phone calls.
- The system will always reserve 64 of the total 256 VoIP DSP resources for SIP voice calls.
- When set in programming the following tables show how many resources are reserved for each video mode. The total number of VoIP resources reserved for video cannot be higher than 192.

*Table 2-99 Non-MCU Mode Video Channel VoIP Reservation*

Program	Max simultaneous video channels	1	2	3	4	5	6	7	8
84-27-20	Mode 1 VoIP Reserved	32	32	64	64	64	96	96	96
84-27-21	Mode 2 VoIP Reserved	32	64	96	128	160	192	N/A	N/A



Table 2-100 MCU Mode Video Channel VoIP Reservation (Peer-to-Peer Enabled Systems)

Program	Max simultaneous group (each group is 4 video channels)	1
84-27-22	MCU Mode 1 VoIP Reserved	64
84-27-23	MCU Mode 2 VoIP Reserved	160

- Video over SIP trunks is not supported for version 1.00 software and will be supported in a later release.
- The combination of Programs 84-27-20, 84-27-21, 84-27-22 and 84-27-23 determine the total number of VoIP DSP resources reserved for video channels (not exceed 192).
- Mode 1 video quality is CIF (352x288).
- Mode 2 video quality is VGA (640x480).
- Video quality mode used depends on the standard SIP device support of that resolution.
- Setting Programs 84-27-22 or 84-27-23 to 1 will allow 4 video channels for MCU video mode type (1 or 2) if DSP resources are available.
- MCU group for mode 1 and mode 2 video cannot be enabled at the same time as it will try to reserve more than 192 VoIP DSP resources for video.
- The system will not allow more than 192 VoIP DSP resources to be reserved for video.
- After making setting changes to Programs 84-27-20, 84-27-21, 84-27-22 or 84-27-23 the VoIP daughter board must be reset for the changes to take effect. This will happen automatically once all VoIP resources go idle.
- Up to 256 VoIP DSP resources are available when the SV9100 is properly licensed.
- Video streaming is not supported to SIP Terminal via Netlink.
- Simple MCU video is not supported for SIP Trunk calls.
- Once VoIP DSP resources have been reserved for video functionality, pressing Feature+4 on an idle display phone will show the number of VoIP DSP resources available for voice calls.

### Default Settings

None

## System Availability

### Terminals

Standard SIP Terminals with video capabilities that are compliant with RFC 3261, RFC 3262, RFC 3264 (Session Description Protocol), RFC 1889 (Real Time Protocol).

### Required Component(s)

- GCD-CP10
- GPZ-IPLE
- 0042 – SV9100 Video MCU Lic
- 0047 – SV9100 Remote Conf Lic
- 0300 – SV9100 Resource Lic
- 1001 – SV9100 InMail VRS Port Lic
- 5111 – SV9100 IP Phone Lic
- 5103 – SV9100 IP Resource Lic
- 0411 – SV9100 Version Lic (R1)

## Related Features

↪ **Conference – Remote**

## Guide to Feature Programming

The **Level 1**, **Level 2** and **Level 3** columns indicate the programs that are assigned when programming this feature in the order they are most commonly used. These levels are used with PCPro and WebPro wizards for feature programming.

- Level 1 – these are the most commonly assigned programs for this feature.
- Level 2 – these are the next most commonly assigned programs for this feature.
- Level 3 – these programs are not often assigned and require an expert level working knowledge of the system to be properly assigned.

◇ *The items highlighted in gray are read only and cannot be changed.*

Program Number	Program Name/Description	Input Data	Default	Level		
				1	2	3
10-03-03	<p><b>ETU Setup – Number of Voice Channels</b> Read only program showing number of VoIP resources available for voice calls.</p> <p>➔ <i>This information can also be viewed by pressing <b>Feature+4</b> on an idle display terminal.</i></p>		Refer to the Programming Manual for default values.			
10-54-01	<p><b>License Configuration for Each Package – License Code</b> Assign VoIP Resource Licenses (5103) to GCD-CP10 slot (1). If applying more than 255 licenses to a slot, the licenses must be applied across multiple indexes. For example, assigning 256 VoIP resource licenses (5103) to the CPU slot could be assigned using different methods as long as the total for the CPU slot is 256.</p> <p>1. Index 1 has 128 of feature code 5103 and index 2 also has 128 of feature code 5103 for a total of 256. 2. Index 1 has 255 of feature code 5103 and index 2 has 1 of feature code 5103 for a total of 256.</p>	1 ~ 255 Resource Licenses	0		✓	
11-19-01	<p><b>Remote Conference Group Pilot Number</b> Enter the pilot number for remote conference.</p>	Must work within current system dialing plan.	No Setting	✓		
14-18-03	<p><b>IP Trunk Data Setup – P2P Mode (SIP Trunk)</b> Select whether or not peer-to-peer connection method is used for the SIP Trunk.</p>	0 = Disable 1 = Enable	0		✓	
14-18-04	<p><b>IP Trunk Data Setup – Video Mode (SIP Trunk)</b> Select whether or not the video mode is used for the SIP Trunk.</p> <p>➔ <i>This program is not supported for v 1.00 and will be added in a future release.</i></p>	0 = Disable 1 = Enable	0		✓	
15-05-43	<p><b>IP Telephone Terminal Basic Data Setup – Video Mode</b> Enable/Disable Video Mode for Standard SIP terminals.</p>	0 = Disable 1 = Enable	0	✓		
15-05-50	<p><b>IP Telephone Terminal Basic Data Setup – Peer to Peer Mode</b> On a per station basis enable or disable Peer to Peer mode.</p> <p>➔ <i>If enabled, MUC mode resource settings are used in Programs 84-27-22 and 84-27-23.</i></p> <p>➔ <i>If disabled, non-MCU mode resource settings are used in Programs 84-27-20 and 84-27-21.</i></p>	0 = Disable 1 = Enable	1		✓	

Program Number	Program Name/Description	Input Data	Default	Level		
				1	2	3
20-13-46	<b>Class of Service Options (Supplementary Service) – Remote Conference</b> Set Class of Service option for Remote conference.	0 = Disable 1 = Enable	COS 1 ~ 15 = 1		✓	
20-34-01	<b>Remote Conference Group Setting – Remote Conference - Name</b> Set name for remote conference.	Maximum of 12 characters.	Conferences 1 ~ 4 = Conf 1 - Conf 4 Conferences 5 ~ 20 = blank		✓	
20-34-02	<b>Remote Conference Group Setting – Remote Conference - Password</b> Set password for remote conference.	Maximum of 4 numbers.	Conferences 1 ~ 4 = 1111 Conferences 5 ~ 20 = blank		✓	
20-34-06	<b>Remote Conference Group Setting – Remote Conference - Password Mode</b> Set whether users are prompted to enter a password to access the conference. Normal will prompt users to enter a password. If set to Skip no password is required to enter a conference.	0 = Normal 1 = Skip	0		✓	
20-34-07	<b>Remote Conference Group Setting – MCU Mode for Remote Conference</b> Set the MCU video mode for remote conference. ➡ <i>Setting this value for mode 1 or 2 determines whether 84-27-22 or 84-27-23 is used.</i>	0 = Disable 1 = Mode 1 2 = Mode 2	0		✓	
84-10-01	<b>ToS Setup – ToS Mode</b> When Input Data is set to 1, Item No. 07 is invalid. When Data is set to 2, Items No. 02 ~ 06 are invalid.	0 = Disable (Invalid) 1 = IP Precedence 2 = Diffserv	0			✓
84-10-02	<b>ToS Setup – Priority, IP Precedence</b> 1 = Router queuing priority.	0 ~ 7 0 = Low 7 = High	0			✓
84-10-03	<b>ToS Setup – Low Delay</b> 1 = Optimize for low delay routing.	0 ~ 1 0 = Normal Delay, Low Delay	0			✓
84-10-04	<b>ToS Setup – Wideband (Throughout)</b> 1 = Optimize for high bandwidth routing.	0 ~ 1 0 = Normal Throughput 1 = High Throughput	0			✓
84-10-05	<b>ToS Setup – High Reliability</b> 1 = Optimize for reliability routing.	0 ~ 1 0 = Normal Reliability 1 = Low Reliability	0			✓
84-10-07	<b>ToS Setup – Priority (D.S.C.P. - Differentiated Services Code Point)</b> DSCP (Differentiated Services Code Point).	0 ~ 63	0			✓

Program Number	Program Name/Description	Input Data	Default	Level		
				1	2	3
84-13-70	<p><b>SIP Trunk CODEC Information Basic Setup – Video Quality Mode</b></p> <p>Specifies the SIP trunk video quality mode.</p> <p>Mode 1 = CIF (352x288)</p> <p>Mode 2 = VGA (640x480)</p> <p>➤ <i>Used with Programs 84-27-20 for Mode 1 and 84-27-21 for Mode 2 video quality settings.</i></p> <p>➤ <i>This program is not supported for v 1.00 and will be added in a future release.</i></p>	<p>0 = Mode 1</p> <p>1 = Mode 2</p>	0		✓	
84-13-71	<p><b>SIP Trunk CODEC Information Basic Setup – Video CODEC</b></p> <p>This program specifies the video CODEC (H.264 only).</p> <p>➤ <i>This program is not supported for v 1.00 and will be added in a future release.</i></p>	0 = H.264	0			✓
84-13-72	<p><b>SIP Trunk CODEC Information Basic Setup – Jitter Buffer Mode for Video</b></p> <p>Sets the jitter buffer size adjustment. At default this is set to self adjusting and should only be changed when directed by support.</p> <p>➤ <i>This program is not supported for v 1.00 and will be added in a future release.</i></p>	<p>1 = Static</p> <p>2 = Self adjusting</p>	2			✓
84-13-73	<p><b>SIP Trunk CODEC Information Basic Setup – Minimum Jitter Buffer for Video</b></p> <p>Sets the minimum value of jitter buffer for the video stream.</p> <p>This value must be smaller than the value of the maximum jitter buffer.</p> <p>➤ <i>This value should only be changed if needed for highly congested networks.</i></p> <p>➤ <i>This program is not supported for v 1.00 and will be added in a future release.</i></p>	0 ~ 1000ms	70ms			✓
84-13-74	<p><b>SIP Trunk CODEC Information Basic Setup – Initial Jitter Buffer for Video</b></p> <p>Sets the initial value of jitter buffer for the video stream.</p> <p>This value must be smaller than the value of the maximum jitter buffer and larger than the value of the minimum jitter buffer.</p> <p>➤ <i>This value should only be changed if needed for highly congested networks.</i></p> <p>➤ <i>This program is not supported for v 1.00 and will be added in a future release.</i></p>	0 ~ 1000ms	140ms			✓

Program Number	Program Name/Description	Input Data	Default	Level		
				1	2	3
84-13-75	<p><b>SIP Trunk CODEC Information Basic Setup – Maximum Jitter Buffer for Video</b></p> <p>Sets the maximum value of jitter buffer for the video stream. It is used only when Program 84-19-72 (Jitter Buffer Mode for video) is set to 1: Fixed.</p> <p>This value must be larger than the value of the minimum jitter buffer.</p> <p>➤ <i>This value should only be changed if needed for highly congested networks.</i></p> <p>➤ <i>This program is not supported for v 1.00 and will be added in a future release.</i></p>	0 ~ 1000ms	210ms			✓
84-19-65	<p><b>SIP Extension CODEC Information Basic Setup – Video Quality Mode</b></p> <p>Specifies the SIP station video quality mode when Peer to Peer is disabled in Program 15-05-50.</p> <p>Mode 1 = CIF (352x288)</p> <p>Mode 2 = VGA (640x480)</p> <p>➤ <i>Used with Programs 84-27-20 for Mode 1 and 84-27-21 for Mode 2 video quality settings.</i></p>	0 = Mode 1 1 = Mode 2	0		✓	
84-19-66	<p><b>SIP Extension CODEC Information Basic Setup – Video CODEC</b></p> <p>This program specifies the video CODEC (H.264 only).</p>	0 = H.264	0			✓
84-19-67	<p><b>SIP Extension CODEC Information Basic Setup – Jitter Buffer Mode for Video</b></p> <p>Sets the jitter buffer size adjustment. At default this is set to self adjusting and should only be changed when directed by support.</p>	1 = Static 2 = Self adjusting	2			✓
84-19-68	<p><b>SIP Extension CODEC Information Basic Setup – Minimum Jitter Buffer for Video</b></p> <p>Sets the minimum value of jitter buffer for the video stream.</p> <p>This value must be smaller than the value of the maximum jitter buffer.</p> <p>➤ <i>This value should only be changed if needed for highly congested networks.</i></p>	0 ~ 1000ms	70ms			✓
84-19-69	<p><b>SIP Extension CODEC Information Basic Setup – Initial Jitter Buffer for Video</b></p> <p>Sets the initial value of jitter buffer for the video stream.</p> <p>This value must be smaller than the value of the maximum jitter buffer and larger than the value of the minimum jitter buffer.</p> <p>➤ <i>This value should only be changed if needed for highly congested networks.</i></p>	0 ~ 1000ms	140ms			✓

Program Number	Program Name/Description	Input Data	Default	Level		
				1	2	3
84-19-70	<p><b>SIP Extension CODEC Information Basic Setup – Maximum Jitter Buffer for Video</b></p> <p>Sets the maximum value of jitter buffer for the video stream. It is used only when Program 84-19-72 (Jitter Buffer Mode for video) is set to 1: Fixed.</p> <p>This value must be larger than the value of the minimum jitter buffer.</p> <p>➡ <i>This value should only be changed if needed for highly congested networks.</i></p>	0 ~ 1000ms	210ms			✓
84-26-12	<p><b>IPL Basic Setup – Video RTP Port</b></p> <p>Sets the starting RTP port used by standard SIP terminal video.</p>	0 ~ 65534	20020			✓
84-26-13	<p><b>IPL Basic Setup – Video RTCP Port</b></p> <p>Sets the starting RTCP port used by standard SIP terminal video.</p>	0 ~ 65534	20021			✓
84-27-20	<p><b>IPL Basic Setup – Maximum non-MCU Video Channel Mode 1</b></p> <p>Sets the number of VoIP DSP resources to reserve for non-MCU mode 1 video. This program is used if Peer to Peer is disabled for standard SIP phones.</p> <p>VoIP DSP resources are shared between video and voice calls. The system will always keep 64 resources for voice calls. When changing this program if resources are exceeded the system will provide an error message and will not allow the setting to be changed.</p> <p>➡ <i>When changing this program, all DSP resources are reset when idle. In progress calls are not affected, but until all DSP resources go idle this change will not take affect.</i></p>	0 ~ 8	0		✓	
84-27-21	<p><b>IPL Basic Setup – Maximum non-MCU Video Channel Mode 2</b></p> <p>Sets the number of VoIP DSP resources to reserve for non-MCU mode 2 video. This program is used if Peer to Peer is disabled for standard SIP phones.</p> <p>VoIP DSP resources are shared between video and voice calls. The system will always keep 64 resources for voice calls. When changing this program if resources are exceeded the system will provide an error message and will not allow the setting to be changed.</p> <p>➡ <i>When changing this program, all DSP resources are reset when idle. In progress calls are not affected, but until all DSP resources go idle this change will not take affect.</i></p>	0 ~ 6	0		✓	

Program Number	Program Name/Description	Input Data	Default	Level		
				1	2	3
84-27-22	<p><b>IPL Basic Setup – Maximum MCU Group Number (Mode 1)</b></p> <p>Used to reserve VoIP DSP resources for mode 1 video conferences. When a DSP resource is reserved it is not available for SIP voice calls. VoIP DSP resources are shared between video and voice calls. The system will always keep 64 resources for voice calls. When changing this program if resources are exceeded the system will provide an error message and will not allow the setting to be changed.</p> <p>➤ <i>When changing this program, all DSP resources are reset when idle. In progress calls are not affected, but until all DSP resources go idle this change will not take affect.</i></p>	<p>0 = No MCU video channels reserved</p> <p>1 = 4 MCU video Mode 1 channels reserved</p>	0		✓	
84-27-23	<p><b>IPL Basic Setup – Maximum MCU Group Number (Mode 2)</b></p> <p>Used to reserve VoIP DSP resources for mode 2 video conferences. When a DSP resource is reserved it is not available for SIP voice calls. VoIP DSP resources are shared between video and voice calls. The system will always keep 64 resources for voice calls. When changing this program if resources are exceeded the system will provide an error message and will not allow the setting to be changed.</p> <p>➤ <i>When changing this program, all DSP resources are reset when idle. In progress calls are not affected, but until all DSP resources go idle this change will not take affect.</i></p>	<p>0 = No MCU video channels reserved</p> <p>1 = 4 MCU video Mode 1 channels reserved</p>	0		✓	
84-34-01	<p><b>VoIPDB DTMF Setup – DTMF Relay Mode</b></p> <p>Set DTMF mode for standard SIP extensions. The recommended method is RFC2833. Type 3 SIP Extensions, profile 1.</p>	<p>0 = Disable</p> <p>1 = RFC2833</p> <p>2 = H.245</p>	0	✓		
84-34-02	<p><b>VoIPDB DTMF Setup – DTMF Payload Number</b></p> <p>Set DTMF Payload for standard SIP extensions. Type 3 SIP Extensions, profile 1.</p>	96 ~ 127	110		✓	
84-34-03	<p><b>VoIPDB DTMF Setup – DTMF Detection Type</b></p> <p>Type 3 SIP Extensions, profile 1.</p>	1 ~ 5	1			✓
84-34-04	<p><b>VoIPDB DTMF Setup – DTMF Transmit Type</b></p> <p>Type 3 SIP Extensions, profile 1.</p>	1 ~ 5	1			✓
84-34-05	<p><b>VoIPDB DTMF Setup – DTMF Rely (inband) Retransmit Type</b></p> <p>Type 3 SIP Extensions, profile 1.</p>	1 ~ 5	1			✓



MCU Mode:

Program Number	Program Name/Description	Input Data	Default	Level		
				1	2	3
10-03-03	<p><b>ETU Setup – Number of Voice Channels</b> Read only program showing number of VoIP resources available for voice calls.</p> <p>➡ <i>This information can also be viewed by pressing <b>Feature+4</b> on an idle display terminal.</i></p>		Refer to the Programming Manual for default values.			
11-19-01	<p><b>Remote Conference Group Pilot Number</b> Enter the pilot number for remote conference.</p>	Must work within current system dialing plan.	No Setting	✓		
15-05-43	<p><b>IP Telephone Terminal Basic Data Setup – Video Mode</b> Enable/Disable Video Mode for Standard SIP terminals.</p>	0 = Disable 1 = Enable	0	✓		
15-05-50	<p><b>IP Telephone Terminal Basic Data Setup – Peer to Peer Mode</b> On a per station basis enable or disable Peer to Peer mode.</p> <p>➡ <i>If enabled, MUC mode resource settings are used in Programs 84-27-22 and 84-27-23.</i></p>	0 = Disable 1 = Enable	1		✓	
20-34-01	<p><b>Remote Conference Group Setting – Remote Conference - Name</b> Set name for remote conference.</p>	Maximum of 12 characters.	Conferences 1 ~ 4 = Conf 1 - Conf 4 Conferences 5 ~ 20 = blank		✓	
20-34-02	<p><b>Remote Conference Group Setting – Remote Conference - Password</b> Set password for remote conference.</p>	Maximum of 4 numbers.	Conferences 1 ~ 4 = 1111 Conferences 5 ~ 20 = blank		✓	
20-34-06	<p><b>Remote Conference Group Setting – Remote Conference - Password Mode</b> Set whether users are prompted to enter a password to access the conference. Normal will prompt users to enter a password. If set to Skip no password is required to enter a conference.</p>	0 = Normal 1 = Skip	0		✓	
20-34-07	<p><b>Remote Conference Group Setting – MCU Mode for Remote Conference</b> Set the MCU video mode for remote conference.</p> <p>➡ <i>Setting this value for mode 1 or 2 determines whether 84-27-22 or 84-27-23 is used.</i></p>	0 = Disable 1 = Mode 1 2 = Mode 2	0		✓	

Program Number	Program Name/Description	Input Data	Default	Level		
				1	2	3
84-27-22	<p><b>IPL Basic Setup – Maximum MCU Group Number (Mode 1)</b></p> <p>Used to reserve VoIP DSP resources for mode 1 video conferences. When a DSP resource is reserved it is not available for SIP voice calls. VoIP DSP resources are shared between video and voice calls. The system will always keep 64 resources for voice calls. When changing this program if resources are exceeded the system will provide an error message and will not allow the setting to be changed.</p> <p>➤ <i>When changing this program, all DSP resources are reset when idle. In progress calls are not affected, but until all DSP resources go idle this change will not take affect.</i></p>	<p>0 = No MCU video channels reserved</p> <p>1 = 4 MCU video Mode 1 channels reserved</p>	0		✓	
84-27-23	<p><b>IPL Basic Setup – Maximum MCU Group Number (Mode 2)</b></p> <p>Used to reserve VoIP DSP resources for mode 2 video conferences. When a DSP resource is reserved it is not available for SIP voice calls. VoIP DSP resources are shared between video and voice calls. The system will always keep 64 resources for voice calls. When changing this program if resources are exceeded the system will provide an error message and will not allow the setting to be changed.</p> <p>➤ <i>When changing this program, all DSP resources are reset when idle. In progress calls are not affected, but until all DSP resources go idle this change will not take affect.</i></p>	<p>0 = No MCU video channels reserved</p> <p>1 = 4 MCU video Mode 1 channels reserved</p>	0		✓	

**Non-MCU Mode:**

Program Number	Program Name/Description	Input Data	Default	Level		
				1	2	3
10-03-03	<p><b>ETU Setup – Number of Voice Channels</b></p> <p>Read only program showing number of VoIP resources available for voice calls.</p> <p>➤ <i>This information can also be viewed by pressing <b>Feature+4</b> on an idle display terminal.</i></p>		Refer to the Programming Manual for default values.			
15-05-43	<p><b>IP Telephone Terminal Basic Data Setup – Video Mode</b></p> <p>Enable/Disable Video Mode for Standard SIP terminals.</p>	<p>0 = Disable</p> <p>1 = Enable</p>	0	✓		

Program Number	Program Name/Description	Input Data	Default	Level		
				1	2	3
15-05-50	<p><b>IP Telephone Terminal Basic Data Setup – Peer to Peer Mode</b></p> <p>On a per station basis enable or disable Peer to Peer mode.</p> <p>➔ <i>If disabled, non-MCU mode resource settings are used in Programs 84-27-20 and 84-27-21.</i></p>	<p>0 = Disable 1 = Enable</p>	1		✓	
84-19-65	<p><b>SIP Extension CODEC Information Basic Setup – Video Quality Mode</b></p> <p>Specifies the SIP station video quality mode when Peer to Peer is disabled in Program 15-05-50.</p> <p>Mode 1 = CIF (352x288) Mode 2 = VGA (640x480)</p> <p>➔ <i>Used with Programs 84-27-20 for Mode 1 and 84-27-21 for Mode 2 video quality settings.</i></p>	<p>0 = Mode 1 1 = Mode 2</p>	0		✓	
84-27-20	<p><b>IPL Basic Setup – Maximum non-MCU Video Channel Mode 1</b></p> <p>Sets the number of VoIP DSP resources to reserve for non-MCU mode 1 video. This program is used if Peer to Peer is disabled for standard SIP phones.</p> <p>VoIP DSP resources are shared between video and voice calls. The system will always keep 64 resources for voice calls. When changing this program if resources are exceeded the system will provide an error message and will not allow the setting to be changed.</p> <p>➔ <i>When changing this program, all DSP resources are reset when idle. In progress calls are not affected, but until all DSP resources go idle this change will not take affect.</i></p>	0 ~ 8	0		✓	
84-27-21	<p><b>IPL Basic Setup – Maximum non-MCU Video Channel Mode 2</b></p> <p>Sets the number of VoIP DSP resources to reserve for non-MCU mode 2 video. This program is used if Peer to Peer is disabled for standard SIP phones.</p> <p>VoIP DSP resources are shared between video and voice calls. The system will always keep 64 resources for voice calls. When changing this program if resources are exceeded the system will provide an error message and will not allow the setting to be changed.</p> <p>➔ <i>When changing this program, all DSP resources are reset when idle. In progress calls are not affected, but until all DSP resources go idle this change will not take affect.</i></p>	0 ~ 6	0		✓	

## Operation

None

## Simple Network Management Protocol (SNMP)

### Description

SV9100 system software contains Simple Network Management Protocol (SNMP) support that functions with Private MIB's and SNMP traps. Typically, an administrator uses an SNMP application to centrally manage network devices. Using SNMP on the SV9100 allows it to be managed alongside these other network devices. The SV9100 is considered as an SNMP Agent that can talk to an SNMP application.

Private MIBS allow an SNMP application to make very specific requests to the SV9100 to obtain useful information from the system. Below are examples of the different types of information that is available:

- Hardware Key Code
- Installed Hardware
- System Software
- System Date and Time
- Installed licenses
- VOIP Information

SNMP traps can be used for the purpose of monitoring SV9100 alarms via SNMP. When any of the alarms are triggered on the SV9100, they can be reported in the SNMP application. Details of the available alarms reports are available in [Alarm Reports on page 2-26](#).

A 'MIB' (Management Information Base) file has been created that can be loaded into an SNMP application. An 'OID' (Object ID) of 14399 has been registered for use by NEC for its systems, this is pre-configured in the MIB file.

### Conditions

- An SNMP browser is required to manage and view SNMP traps.
- When properly configured, an SV9100 that enters a condition which causes an alarm will also send SNMP traps to the SNMP browser.
- A properly configured MIB OID file which is fully compiled in the MIB browser is required before the MIB browser can perform Get operations from the SNMP agent.
- The "Target Host" parameter referenced in Program 90-64 is the SNMP network management device(s) that are run on an external PC.
- All MIB OIDs used with the SV9100 begin with 1.3.6.1.4.1.14399.20.10.
- SNMP traps for alarms that are not desired can be turned off in Program 90-10 by setting the alarm type to "Not Set" for the alarm number that corresponds to the SNMP trap number. For instance, SNMP trap 1.3.6.1.4.1.14399.20.10.30.2.6.60.0 is for alarm number 60, notice the second to the last octet in the example SNMP MIB OID.

- The R6 release does not have ability to see remote Netlink systems, only the Primary system is supported.

### MIB File

The MIB file is structured according to the following tables, only data listed here is available via SNMP. The data for each of the items can be read or write. Read is data that can be requested from the system. Write requires that a value be entered in the SNMP application. For example, the slot number would need to be entered when querying a card.

Common MIB OID information is as follows, these OIDs will be seen at the beginning of the NEC portion of each OID used by the SV9100.

- **14399** Marks the beginning of the NEC portion of the OID.
- **20** Represents KTS which means Key Telephone System.
- **10** Cygnus

The MIB OID parameters using the common parameters above are defined in more detail in the following tables.

**10. Position** can be used to obtain information about a card in a specific slot in the system.

Table 2-101 10. Position

Type		Description	Read or Write
10. Position	1. System ID	NetLink System ID	Write
	2. System Card Position	Card Slot Number	Write

**30. CPU** contains several items relating to the CPU. The following tables show a break down of the data available.

Table 2-102 30. CPU

Type			Description	Read or Write
30. CPU	1. System	1. Hardware	1. Hardware Key Code	Read
	2. Main	1. Version	1. CPU Version	Read
			2. CPU Main Software Build Version	Read
			3. System Date and Time	Read
			4. DSP Version	Read

**30. CPU** can also be used to view licenses installed on the CPU. Licenses are split by feature licenses or port licenses. Available feature licenses are as follows:

*Table 2-103 Feature Licenses*

Type			Description	Read or Write
30. CPU	2. Main	2. Licenses	0002. Cygnus-Link	Read
			0007. Hotel/Motel (PMS)	Read
			0008. SMDR	Read
			0009. Remote Upgrade	Read
			0013. Q-Sig	Read
			0016. K-CCIS	Read
			0018. SIP T.38 FAX Relay	Read
			0030. Encryption	Read
			0040. SIP Video	Read
			0041. XML Pro	Read
			0123. OAI Activation	Read
			2001. Activation	Read
			2101. P-event	Read

Available port licenses are as follows:

*Table 2-104 Port Licenses*

Type			Description	Read or Write
30. CPU	2. Main	2. Licenses	0111. 1st Party CTI (Ethernet)	Read
			0112. 3rd Party CTI Client	Read
			2002. Client	Read
			5001. IP Trunk (SIP/H323)	Read
			5012. K-CCIS over IP	Read
			5111. IP Terminal	Read
			5201. Mobile Extension	Read

Table 2-105 Network, Interface, Trapset and Trap

Type			Description	Read or Write
30. CPU	2. Main	3. Network	1. CPU Card Address	Read
			2. CPU Subnet Mask	Read
			3. CPU Default Gateway	Read
			4. CPU MAC Address	Read
	4. Interface	1~24. Type of card inserted in slot	Read	
	5. Trapset	1~100. Alarm Report	Write	
	6. Trap	1~100. Alarm Report	Read	

40. VOIP can be used to determine information about the IPL card.

Table 2-106 IPL Information Using VOIP

Type		Description	Read or Write
40. VOIPDB	1. Hardware	1. VOIP Type	Read
	2. Status	1. VOIP Card Address	Read
		2. VOIP Subnet Mask	Read
		3. VOIP Card MAC Address	Read
	4. Gateway	1. Gateway 1 IP Address	Read
		2. Gateway 2 IP Address	Read
		3. Gateway 3 IP Address	Read
		4. Gateway 4 IP Address	Read
		5. Gateway 5 IP Address	Read
		6. Gateway 6 IP Address	Read
		7. Gateway 7 IP Address	Read
8. Gateway 8 IP Address		Read	

20. Common can be used to determine hardware versions and system port numbers.

Table 2-107 20. Common

Type		Description	Read or Write
20. Common	1. Card Info	1. Version	1. Hardware Version
		2. Hardware	1. Port Number



## Default Settings

None

## System Availability

### Terminals

None

### Required Component(s)

None

## Related Features

None

## Guide to Feature Programming

The **Level 1**, **Level 2** and **Level 3** columns indicate the programs that are assigned when programming this feature in the order they are most commonly used. These levels are used with PCPro and WebPro wizards for feature programming.

- Level 1 – these are the most commonly assigned programs for this feature.
- Level 2 – these are the next most commonly assigned programs for this feature.
- Level 3 – these programs are not often assigned and require an expert level working knowledge of the system to be properly assigned.

Program Number	Program Name/Description	Input Data	Default	Level		
				1	2	3
10-12-13	<b>GCD-CP10 Network Setup – DNS Primary Address</b> Set the IP Address of the Primary DNS server.	0.0.0.0 ~ 126.255.255.254 128.0.0.1 ~ 191.255.255.254 192.0.0.1 ~ 223.255.255.254	0.0.0.0		✓	
10-12-14	<b>GCD-CP10 Network Setup – DNS Secondary Address</b> Set the IP Address of the Secondary DNS server.	0.0.0.0 ~ 126.255.255.254 128.0.0.1 ~ 191.255.255.254 192.0.0.1 ~ 223.255.255.254	0.0.0.0		✓	
10-12-15	<b>GCD-CP10 Network Setup – DNS Port</b> Set the port number of the DNS server.	0 ~ 65535	53		✓	
90-64-01	<b>SNMP Setup – SNMP</b> Set to enable the SNMP feature.	0 = Disable 1 = Enable	0	✓		

Program Number	Program Name/Description	Input Data	Default	Level		
				1	2	3
90-64-02	<b>SNMP Setup – Community Name</b> Enter the SNMP community name.	Maximum of 12 characters.	Public	✓		
90-64-03	<b>SNMP Setup – Target Host 1</b> Enter the IP Address of the PC running the SNMP application.	XX.XX.XX.XX	0.0.0.0	✓		
90-64-04	<b>SNMP Setup – Target Host 2</b> Enter the IP Address of the PC running the SNMP application.	XX.XX.XX.XX	0.0.0.0		✓	
90-64-05	<b>SNMP Setup – Target Host 3</b> Enter the IP Address of the PC running the SNMP application.	XX.XX.XX.XX	0.0.0.0		✓	
90-64-06	<b>SNMP Setup – Target Host 4</b> Enter the IP Address of the PC running the SNMP application.	XX.XX.XX.XX	0.0.0.0		✓	
90-64-07	<b>SNMP Setup – Target Host 5</b> Enter the IP Address of the PC running the SNMP application.	XX.XX.XX.XX	0.0.0.0		✓	
90-64-08	<b>SNMP Setup – Domain Name</b> Enter the Domain name.	Maximum of 255 characters.	0.0.0.0		✓	
90-64-09	<b>SNMP Setup – Trap Set Message</b> When set to Not Accept, the trap message is sent to the SNMP application for Major and Minor Alarms. When set to Accept, all trap messages set to the SNMP application are sent. ➤ <i>When Program 90-64-09 is set to Not Accept, all alarms that are Minor or Major are output as a trap message. For each Alarm in Program 90-10, it is possible to set the Alarm type to Major, Minor and Not Set. With Program 90-64-09 set to Not Accept, any alarms set to Not Set are not trapped.</i>	0 = Not Accept 1 = Accept	0	✓		

## Operation

### Using the MIB File Example

When the MIB file has been loaded into an SNMP application, it can send requests to the SV9100 and the SV9100 will send a response back. The request is made up from information available in the MIB file. Refer to [Figure 2-80 SNMP – Hardware Key Code Request](#) and [Figure 2-81 SNMP – CPU IP Address Request](#) for two examples of how these requests and responses are processed in regards to the hardware key code and the CPU IP address.

First, the SNMP user can make a request in the application to retrieve the hardware key code. This request is received by the SV9100 and in turn sends back the hardware key code via SNMP.

Figure 2-80 SNMP – Hardware Key Code Request

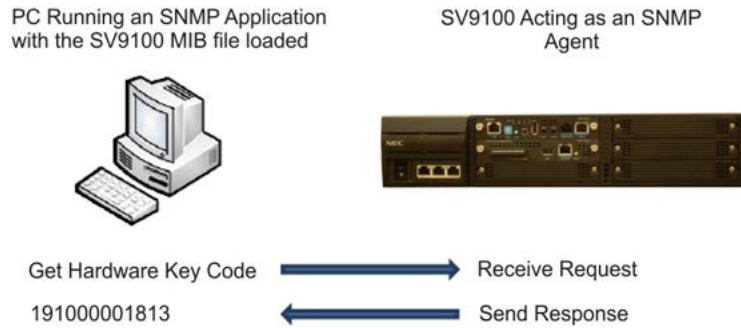

Similarly, the SNMP user can make a request for the CPU IP address. This is received and sent back via SNMP.

Figure 2-81 SNMP – CPU IP Address Request



### Using SNMP Traps Example

SNMP Traps can be used to provide notifications to an SNMP application when an SV9100 alarm has been triggered on the SV9100. For an alarm to be trapped, it has to be set to Major or Minor in Program 90-10-01. Usually the SNMP application has to be configured to watch for a particular trap to be triggered.

The user first sets a trap for alarm 64. When alarm 64 occurs, an SNMP message is sent out that the SNMP application picks up and displays.

Figure 2-82 SNMP – Set Trap Alarm 64

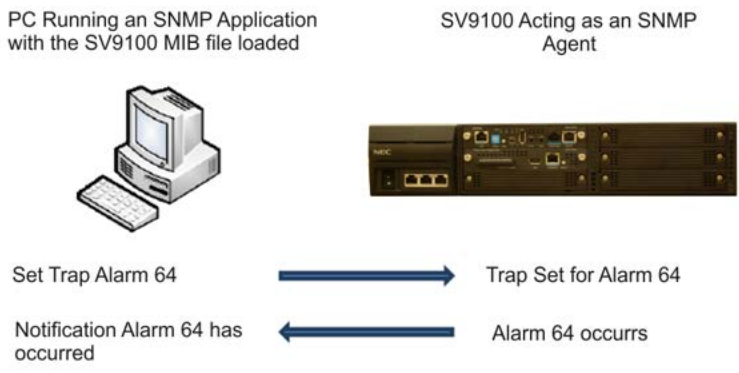

- ◇ The details of the alarm is sent in the trap message displayed in the SNMP application. Refer to [Figure 2-83 SNMP – Trap Alarm Details](#) for information available in the alarm display.

Figure 2-83 SNMP – Trap Alarm Details

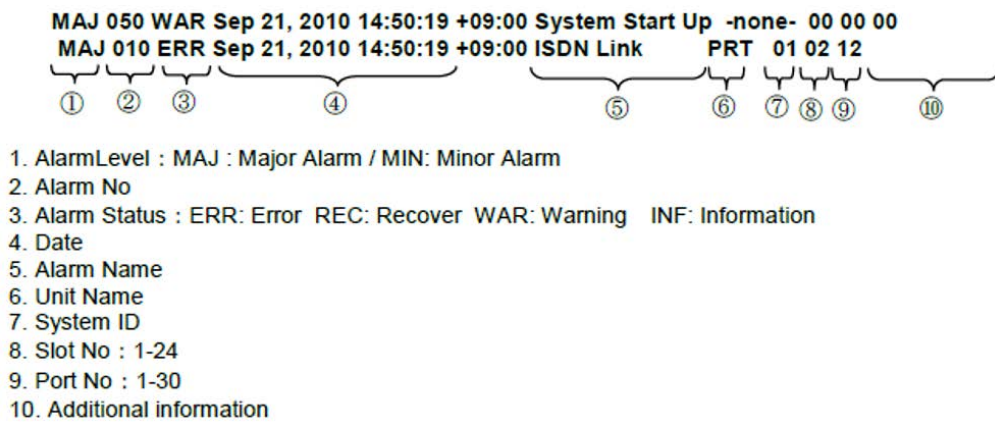

## Single Line Telephones, Analog 500/2500 Sets

### Description

The system is compatible with 500 type (Dial Pulse) and 2500 type (DTMF) analog single line telephones (SLTs). You can install single line telephones as On-Premise or Off-Premise extensions. Single line telephone users can dial codes to access many of the features available to multiline terminal users. With single line telephones, you can have your system simulate PBX operation.

There are 320 single line telephones available (note that this number may be restricted due to system power requirements).

When installing single line telephones you must have:

- A port on an LCA blade for each single line telephone installed.
- If you have 2500 sets, at least one block reserved on the GCD-CP10 for analog extension DTMF reception.

### DTMF Dial Out Timer Added

A program is added for DTMF dialing, Program 20-03-07 : System Options for Single Line Telephones - Trunk Call Dial Forced Sending Start Time (Forced Dial). When Program 20-03-03 : System Options for Single Line Telephones – SLT DTMF Dial to Trunk Lines is set to 0 (receive all digits before sending), the system follows the timer in Program 20-03-04 and Program 20-03-07.

The timer in Program 20-03-04 System Options for Single Line Telephones – Dial Sending Start Time for SLT or ARS resets when the user dials another digit.

The timer in Program 20-03-07 System Options for Single Line Telephones – Trunk Call Dial Forced Sending Start Time (Forced Dial) does not reset when a digit is dialed. The user must finish dialing all the digits before this time expires (entries: 0~64800 seconds, default: 0).

### Conditions

- Dial Pulse (500 type) single line telephones cannot access any feature that requires the user to dial # or \*.
- A single line telephone can initiate an Internal Zone page, but cannot receive an Internal Zone Page.
- When a Ring Group call rings a single line station, the BLF indication shows busy.
- Stutter Dial Tone is supported to Single Line Telephones for Voice Mail Message Waiting.
- The GCD-CP10 has 32 resources for DTMF receiving and Dial Tone detection. When a GPZ-BS10 is installed there are 64 resources available.

- When Program 10-09-01 is set to 0 (Common) and Program 14-02-10 (Caller ID) is set to 1 (Yes), all DTMF/Dial Tone Detection resources are always allocated to analog trunks, not analog extensions. However, if Program 14-02-10 (Caller ID) is set to 0 (No), all DTMF/Dial Tone Detection resources can be used for both analog trunks and analog extensions.
- The Exclusive Hold Recall Timer is used when an internal call from a Single Line Telephone is placed on hold.
- A maximum of two single line telephones can be connected, in series, on one port as long as the maxim cable resistance stays below 600 Ohms.

## Default Settings

Single line telephones function as soon as they are installed and properly programmed.

## System Availability

### Terminals

All Single Line Terminals

### Required Component(s)

- GCD-4LCA
- GPZ-4LCA
- GCD-8LCA
- GPZ-8LCE

## Related Features

Single line telephone users have access to the following features:

- ↳ **Account Code Entry**
- ↳ **Alarm**
- ↳ **Automatic Route Selection (ARS)**
- ↳ **Barge-In**
- ↳ **Callback**
- ↳ **Call Forwarding**
- ↳ **Call Forwarding with Follow Me**
- ↳ **Call Forwarding/Do Not Disturb Override**
- ↳ **Call Waiting/Camp-On**
- ↳ **Central Office Calls, Answering**
- ↳ **Central Office Calls, Placing**
- ↳ **Conference**
- ↳ **Department Calling**
- ↳ **Department Step Calling**
- ↳ **Directed Call Pickup**
- ↳ **Door Box**
- ↳ **Do Not Disturb**
- ↳ **Flash**
- ↳ **Forced Trunk Disconnect**
- ↳ **Group Call Pickup**
- ↳ **Handsfree Answerback/Forced Intercom Ringing**
- ↳ **Hold**
- ↳ **Intercom**
- ↳ **Last Number Redial**
- ↳ **Line Preference**
- ↳ **Meet Me Conference**
- ↳ **Meet Me Paging**
- ↳ **Meet Me Paging Transfer**
- ↳ **Message Waiting**
- ↳ **Night Service**
- ↳ **Off-Hook Signaling**
- ↳ **Paging, External**
- ↳ **Paging, External (VRS)**
- ↳ **Paging, Internal**
- ↳ **PBX Compatibility**
- ↳ **Ringdown Extension, Internal/External**
- ↳ **Save Number Dialed**
- ↳ **Selectable Display Messaging**
- ↳ **Speed Dial – System/Group/Station**
- ↳ **Transfer**
- ↳ **Trunk Queuing/Camp-On**
- ↳ **InMail**
- ↳ **Voice Over**
- ↳ **Warning Tone for Long Conversation**

## Data Communications

APA and APR modules can be used with multiline terminals to provide an analog port.

Refer to the individual features for additional descriptive, programming and operational information.

## Guide to Feature Programming

The **Level 1**, **Level 2** and **Level 3** columns indicate the programs that are assigned when programming this feature in the order they are most commonly used. These levels are used with PCPro and WebPro wizards for feature programming.

- Level 1 – these are the most commonly assigned programs for this feature.
- Level 2 – these are the next most commonly assigned programs for this feature.
- Level 3 – these programs are not often assigned and require an expert level working knowledge of the system to be properly assigned.

Program Number	Program Name/Description	Input Data	Default	Level		
				1	2	3
10-03-01	<b>ETU Setup (DLCA PKG Setup) – Terminal Type (B1)</b> Program all on-premise 500/2500 type single line telephones with circuit type 2. Set the DIOPU trunk to type 1 when trunks should be defined for off-premise extension (OPX) use.	0 = Not set 1 = Multiline Terminal 3 = Bluetooth Cordless Handset 6 = PGD (Paging) 7 = PGD (Tone Ringer) 8 = PGD (Doorbox) 9 = PGD (ACI) 10 = DSS Console 11 = -- Not Used --	0		✓	
10-03-03	<b>ETU Setup (LCA PKG Setup) – Transmit Gain Level (S-Level)</b> Set up and confirm the Basic Configuration data for each blade.	1 ~ 57 (-15.5 +15.5dB)	32 (0dB)		✓	
10-03-04	<b>ETU Setup (LCA PKG Setup) – Receive Gain Level (R-Level)</b> Assign transmit and receive levels for 500/2500 type single line telephones.	1 ~ 57 (-15.5 +15.5dB)	32 (0dB)		✓	



Program Number	Program Name/Description	Input Data	Default	Level		
				1	2	3
10-09-01	<p><b>DTMF and Dial Tone Circuit Setup</b></p> <p>If the system has 2500 type (DTMF) single line extensions, allocate at least one circuit for analog extension DTMF reception (0 or 1). Use the following as a guide when allocating DTMF receivers:</p> <ul style="list-style-type: none"> <li>○ In light traffic sites, allocate one DTMF receiver for every 10 devices that use them.</li> <li>○ In heavy traffic sites, allocate one DTMF receiver for every five devices that use them.</li> </ul> <p>➤ <i>The GCD-CP10 has 32 resources for DTMF receiving and Dial Tone detection. When a GPZ-BS10 is installed there are 64 resources available.</i></p> <p>➤ <i>When Program 10-09-01 is set to 0 (Common) and Program 14-02-10 (Caller ID) is set to 1 (Yes), all DTMF/Dial Tone Detection resources are always allocated to analog trunks, not analog extensions. However, if Program 14-02-10 (Caller ID) is set to 0 (No), all DTMF/Dial Tone Detection resources can be used for both analog trunks and analog extensions.</i></p>	<p>0 = Common Use 1 = Extension Only 2 = Trunk Only</p>	<p>Circuit/Resource 01 ~ 08 = 1 (Extensions) Circuit/Resource 09 ~ 32 = 2 (Trunks) Circuit/Resource 33 ~ 144 = 0 (Common) When GPZ-BS10 is installed, 81 ~ 144 are available</p>		✓	
15-03-01	<p><b>Single Line Telephone Basic Data Setup – SLT Signaling Type</b></p> <p>Enter 0 if single line telephone is a 500 type (dial pulse). Enter 1 if single line telephone is a 2500 type (DTMF).</p> <p>➤ <i>Set In-Skin Voice Mail and InMail to 0.</i></p>	<p>0 = DP 1 = DTMF</p>	1		✓	
15-03-03	<p><b>Single Line Telephone Basic Data Setup – Terminal Type</b></p> <p>Enter 1 for this option to allow a single line port to receive DTMF tones after the initial call setup. Enter 0 to have the port ignore DTMF tones after the initial call setup. For Voice Mail, always enter 1 (e.g., receive DTMF tones).</p>	<p>0 = Normal 1 = Special</p>	0		✓	
15-03-05	<p><b>Single Line Telephone Basic Data Setup – Trunk Polarity Reverse</b></p> <p>-- Not Used in U.S. -- Do Not Change Default Entry as DTMF issues may arise with voice mail.</p>	<p>0 = Off 1 = On</p>	0		✓	
15-03-06	<p><b>Single Line Telephone Basic Data Setup – Extension Polarity Reverse</b></p> <p>-- Not Used in U.S. -- Do Not Change Default Entry as DTMF issues may arise with voice mail.</p>	<p>0 = Disable (Off) 1 = Enable (On)</p>	0		✓	
15-03-07	<p><b>Single Line Telephone Basic Data Setup – Enabled On-Hook When Holding (SLT)</b></p> <p>Enable/Disable this program step.</p>	<p>0 = Disable 1 = Enable</p>	1		✓	

Program Number	Program Name/Description	Input Data	Default	Level		
				1	2	3
15-03-08	<b>Single Line Telephone Basic Data Setup – Answer On-Hook when Holding (SLT)</b> Enable/Disable Answer ON-Hook when Holding for SLT terminals.	0 = Disable (No) 1 = Enable (Yes)	1		✓	
15-03-09	<b>Single Line Telephone Basic Data Setup – Caller ID Function - For External Module</b> Enable/Disable the Caller ID FSK signal for an external Caller ID module or a 3rd-Party vendor telephone with Caller ID display. <b>Important:</b> If voice mail is used, this setting must be disabled for the system integration codes to be correct. With a 2500 set (no Caller ID) installed, this must be set to 0 for incoming callers to have a talk path.	0 = Disable 1 = Enable	0		✓	
15-03-10	<b>Single Line Telephone Basic Data Setup – Caller ID Name</b> Determine if an extension user telephone should display the Caller ID name.	0 = Disable 1 = Enable	1		✓	
15-03-14	<b>Single Line Telephone Basic Data Setup – Forwarded Caller ID Display Mode</b> Determine what the display shows when a multiline terminal receives a forwarded outside call.	0 = Calling Extension Number (Calling) 1 = External Caller ID (Forward)	0		✓	
20-03-01	<b>System Options for Single Line Telephones – SLT Call Waiting Answer Mode</b> For a busy single line (500/2500 type) telephone, set the mode used to answer a camped-on trunk call. For ESL sets, enable this option (1) to allow the user to dial Service Code for Voice Mail Conversation Record.	0 = Hookflash (Hooking) 1 = Hookflash + Service Code 794 ➤ <i>Service Code 654 is for Live Recording at SLT (Program 11-12-53).</i>	0		✓	
20-03-02	<b>System Options for Single Line Telephones – Ignore Received DP Dial on DTMF SLT Port</b> Define whether the system should receive dial pulse and DTMF signals (0) or ignore dial pulse and only accept DTMF signals (1).	0 = Do not ignore (No) 1 = Ignore (Yes)	0		✓	
20-03-03	<b>System Options for Single Line Telephones – SLT DTMF Dial to Trunk Lines</b> Set the SLT phones to (0). Collect all digits before sending or (1), send out immediately after receiving. When using a third-party external paging device, set this option to 1. In addition, set Program 20-03-04 to 1.	0 = Receive all dialed data, before sending (All) 1 = Direct through out (Direct)	0		✓	

Program Number	Program Name/Description	Input Data	Default	Level		
				1	2	3
20-03-04	<b>System Options for Single Line Telephones – Dial Sending Start Time for SLT or ARS</b> Set the time before the first digit is sent out. When using a third-party external paging device, set this option to 1. In addition, set Program 20-03-03 to 1.	0 ~ 64800 seconds	3		✓	
20-03-05	<b>System Options for Single Line Telephones – SLT Operation Mode</b> Define the Operation Mode for SLT terminals.	0 = Normal Mode 1 = Extended Mode1 2 = Extended Mode2	0		✓	
20-03-06	<b>System Options for Single Line Telephones – Headset Ringing Start Time (for SLT)</b> Define the headset ringing start time. After this time expires from the time when a single line telephone is off-hook, the system sets the single line telephone to headset ringing mode.	0 ~ 64800 seconds	5		✓	
20-03-07	<b>System Options for Single Line Telephones – Trunk Call Dial Forced Sending Start Time (Forced Dial)</b> Define the Trunk Call Dial Forced Sending Start Time.	0 ~ 64800 seconds	0		✓	
20-06-01	<b>Class of Service for Extensions</b> Assign a unique Class of Service for Dual OPX telephones only when using Continued Dialing.	Day Night/Mode: 1 ~ 8 Class of Service of Extensions (1 ~ 15)	Extension port 101 = Class 15 All other extension port = Class 1		✓	
20-13-13	<b>Class of Service Options (Supplementary Service) – Continued Dialing (DTMF) Signal on ICM Call</b> Turn Off or On an extension user ability to use Continued Dialing, which allows DTMF signal sending while talking on extension.	0 = Off 1 = On	COS 1 ~ 15 = 1		✓	
20-15-01	<b>Ring Cycle Setup – Normal Incoming Call on Trunk</b> Define the ringing cycle (1 ~ 13) for normal incoming trunk calls (DIL, ring group, etc.).	Ringing Cycle = 1 ~ 13	2		✓	
20-15-03	<b>Ring Cycle Setup – Incoming Internal Call</b> Define the ringing cycle (1 ~ 13) for ICM calls.	Ringing Cycle = 1 ~ 13	12		✓	
20-15-05	<b>Ring Cycle Setup – DID/DDI</b> Define the ringing cycle (1 ~ 13) for DID calls.	Ringing Cycle = 1 ~ 13	8		✓	
80-03-01	<b>DTMF Tone Receiver Setup – Detect Level</b> Use Items 11 ~ 32 to set the criteria for dial tone detection for outgoing ARS calls.	0 = 0dBm ~ -25dBm 1 = -5dBm ~ -30dBm 2 = -10dBm ~ -35dBm 3 = -15dBm ~ -40dBm 4 = -20dBm ~ -45dBm 5 = -25dBm ~ -50dBm 6 = -30dBm ~ -55dBm	Type 1 ~ 5 = 0			✓

Program Number	Program Name/Description	Input Data	Default	Level		
				1	2	3
80-03-02	<b>DTMF Tone Receiver Setup – Start delay time</b> Define the start delay time for DTMF Tone Receiver.	0 ~ 255 (0.25ms ~ 64ms)	Type 1 ~ 5 = 0			✓
80-03-03	<b>DTMF Tone Receiver Setup – Min. detect level</b> Define the minimum detection level for DTMF Tone Receiver.	0 ~ 15 detect level 0: -10dBm(0) to -25dBm(15) detect level 1: -15dBm(0) to -30dBm(15) detect level 2: -20dBm(0) to -35dBm(15) detect level 3: -25dBm(0) to -40dBm(15) detect level 4: -30dBm(0) to -45dBm(15) detect level 5: -35dBm(0) to -50dBm(15) detect level 6: -40dBm(0) to -55dBm(15) detect level 7: -45dBm(0) to -60dBm(15) detect level 8: -50dBm(0) to -65dBm(15) detect level 9: -55dBm(0) to -70dBm(15) detect level 10: -60dBm(0) to -75dBm(15) detect level 11: -65dBm(0) to -80dBm(15) detect level 12: -70dBm(0) to -85dBm(15) detect level 13: -75dBm(0) to -90dBm(15) detect level 14: -80dBm(0) to -95dBm(15) detect level 15: -85dBm(0) to -100dBm(15)	Type 1 = 10 (-20dBm) Type 2 ~ 3 = 15 (-25dBm) Type 4 ~ 5 = 10 (-20dBm)			✓

Program Number	Program Name/Description	Input Data	Default	Level		
				1	2	3
80-03-04	<b>DTMF Tone Receiver Setup – Max. detect level</b> Define the maximum detection level for DTMF Tone Receiver.	0 ~ 15 detect level 0: 0dBm(0) to -15dBm(15) detect level 1: -5dBm(0) to -20dBm(15) detect level 2: -10dBm(0) to -25dBm(15) detect level 3: -15dBm(0) to -30dBm(15) detect level 4: -20dBm(0) to -35dBm(15) detect level 5: -25dBm(0) to -40dBm(15) detect level 6: -30dBm(0) to -45dBm(15) detect level 7: -35dBm(0) to -50dBm(15) detect level 8: -40dBm(0) to -55dBm(15) detect level 9: -45dBm(0) to -60dBm(15) detect level 10: -50dBm(0) to -65dBm(15) detect level 11: -55dBm(0) to -70dBm(15) detect level 12: -60dBm(0) to -75dBm(15) detect level 13: -65dBm(0) to -80dBm(15) detect level 14: -70dBm(0) to -85dBm(15) detect level 15: -75dBm(0) to -90dBm(15)	Type 1 ~ 5 = 2 (-2dBm)			✓
80-03-05	<b>DTMF Tone Receiver Setup – Forward twist level</b> Define the forward twist level for DTMF Tone Receiver.	0 ~ 9 (1dB ~ 10dB)	Type 1 = 5 (6dBm) Type 2 = 5 (6dBm) Type 3 = 5 (6dBm) Type 4 = 5 (6dBm) Type 5 = 5 (6dBm)			✓

Program Number	Program Name/Description	Input Data	Default	Level		
				1	2	3
80-03-06	<b>DTMF Tone Receiver Setup – Backward twist level</b> Define the backwards twist level for DTMF Tone Receiver.	0 ~ 9 (1dB ~ 10dB)	Type 1 = 0 (1dBm) Type 2 = 0 (1dBm) Type 3 = 0 (1dBm) Type 4 = 0 (1dBm) Type 5 = 0 (1dBm)			✓
80-03-07	<b>DTMF Tone Receiver Setup – ON detect time</b> Define the On detection time for DTMF Tone Receiver.	1 ~ 255 (15+ 15ms ~ 3825ms)	<b>Version 1000</b> Type 1 ~ 5 = 1 (30ms)			✓
			<b>Version 3000 or higher</b> Type 1 ~ 5 = 3 (60ms)			
80-03-08	<b>DTMF Tone Receiver Setup – OFF detect time</b> Define the Off detection time for DTMF Tone Receiver.	1 ~ 255 (15+ 15ms ~ 3825ms)	<b>Version 1000</b> Type 1 ~ 5 = 1 (30ms)			✓
			<b>Version 3000 or higher</b> Type 1 ~ 5 = 2 (45ms)			
80-04-01	<b>Call Progress Tone Detector Setup – Detection Level</b> If required, modify the criteria for dial tone detection and call progress tone detection for the DTMF tones received at a single line telephone.	0 = 0dBm ~ -25dBm 1 = -5dBm ~ -30dBm 2 = -10dBm ~ -35dBm 3 = -15dBm ~ -40dBm 4 = -20dBm ~ -45dBm 5 = -25dBm ~ -50dBm 6 = -30dBm ~ -55dBm	Type 1 (DT) – 0 (-25dBm) Type 2 (BT) – 0 (-25dBm) Type 3 (RBT) – 0 (-25dBm) Type 4, Type 5 – 0		✓	
80-04-04	<b>Call Progress Tone Detector Setup – No tone time</b> Set No Tone Time.	0 ~ 255 (30 + 30 ~ 7680ms) (0 = not detect) 1 ~ 255 = 60 ~ 7680ms The formula is 30 + 30N. When set to N = 1, it means 30 + 30 * 1 = 60. When set to N=255, it means 30+30*255=7680	Type 1 (DT) – 132 (3990ms) Type 2 (BT) – 132 (3990ms) Type 3 (RBT) – 132 (3990ms) Type 4, Type 5 – 0			✓
82-11-01	<b>LCA Initial Setup – Bounce Protect Time</b> Specify a time for detection of a valid off-hook indication that is long enough to prevent an unintentional bounce of the receiver from being detected as a new off-hook indication from a Single Line Telephone.	0 = No Setting 1 ~ 15 = 100ms ~ 1.5sec	3			✓

Program Number	Program Name/Description	Input Data	Default	Level		
				1	2	3
82-11-02	<b>LCA Initial Setup – HookFlash Start Time</b> Specify the minimum hookflash time from a Single Line Telephone or analog Voice Mail system before it is detected as the beginning of a valid hookflash.	0 = 40ms 1 ~ 15 = 90ms ~ 790ms	5 [290ms]			✓
82-11-03	<b>LCA Initial Setup – HookFlash End Time</b> Specify the maximum hookflash duration from a Single Line Telephone to receive a second dial tone.	0 = HST+0ms 1 ~ 15 = HST+100ms ~ HST+1500ms (HST = Hookflash Start Time)	7			✓

## Operation

Refer to the individual features listed in the Related Features section of this feature.

## Description

Each display telephone provides interactive softkeys for intuitive feature access. It is not necessary to remember feature codes to access the telephone advanced features because the function of the softkeys change as the user processes calls.

Additional options allow you to fine tune the multiline terminal volume levels for handset receive and transmit, speaker volume, ringer and handset volume, and headset volume levels. You can also customize the point at which the built-in speakerphone switches from transmit to receive; a boon for noisy environments. The display telephones also have a contrast control for the LCD display.

### Conditions

- If a feature is restricted by an extension Class of Service, though the Softkey menu still displays the option, the user cannot set the feature.
- Using the Directory Dialing Softkeys, Recall can toggle the language display from English to Japanese.
- The feature must be active to change the volume (e.g., telephone must be ringing, page being heard, etc.). Press the volume keys when the telephone is idle to adjust the display contrast.
- Disabling the softkeys or limiting the menu key is supported with SV9100 system software.
- When a Softkey is disabled, the Softkey is not displayed on the LCD (depending on the feature it may appear) and related keys are not functional. Cursor keys and the Menu key are also disabled.
  - ◇ *To use the Disable Softkey function, Program 15-02-71 must be set to 1 (On) at associated terminal.*

### Default Settings

Display shows time/date/extension/Softkey menu information.

## System Availability

### Terminals

All Multiline Terminals



Required Component(s)

None

Related Features

- ➔ **Directory Dialing**
- ➔ **Volume Controls**

Guide to Feature Programming

The **Level 1**, **Level 2** and **Level 3** columns indicate the programs that are assigned when programming this feature in the order they are most commonly used. These levels are used with PCPro and WebPro wizards for feature programming.

- Level 1 – these are the most commonly assigned programs for this feature.
- Level 2 – these are the next most commonly assigned programs for this feature.
- Level 3 – these programs are not often assigned and require an expert level working knowledge of the system to be properly assigned.

Program Number	Program Name/Description	Input Data	Default	Level		
				1	2	3
11-11-13	<b>Service Code Setup (for Setup/Entry Operation) – Display Language Selection for Multiline Terminal</b> Customize the service code used to select the display language for a multiline terminal.	MLT 0 ~ 9, *, # Maximum of eight digits	678		✓	
15-02-01	<b>Multiline Telephone Basic Data Setup – Display Language Selection</b> Select the language to be displayed on a multiline terminal display.	0 = Japanese 1 = English 2 = German 3 = French 4 = Italian 5 = Spanish 6 = Dutch 7 = Portuguese 8 = Norwegian 9 = Danish 10 = Swedish 11 = Turkish 12 = Latin American Spanish 13 = Romanian 14 = Polish	1		✓	

Program Number	Program Name/Description	Input Data	Default	Level		
				1	2	3
15-02-71	<b>Multiline Telephone Basic Data Setup – Disable Softkey</b> Disable (1) softkey buttons and limit the softkey display. Also limits the Menu key left and right buttons.	0 = Off 1 = On	0			✓

## Operation

None

## Speed Dial – System/Group/Station

### Description

Speed Dialing gives an extension user quick access to frequently called numbers. This saves time, for example, when calling a client with whom they deal often. Instead of dialing a long telephone number, the extension user just dials the Speed Dialing code.

There are three types of Speed Dialing: System, Group and Station. All co-workers can share the System Speed Dialing numbers. All co-workers in the same Speed Dialing Group can share the Group Speed Dialing numbers. Station Speed Dialing numbers are available only at a user's own extension. The system has 10000 Speed Dialing bins that you can allocate between System and Group Speed Dialing and a maximum of 64 Speed Dialing Groups are available. Each extension has 10 Station Speed Dial bins.



NOTE

*Each Speed Dialing bin can store a number with up to 24 digits.*

When placing an Speed Dialing call, the system normally routes the call through Trunk Group Routing or ARS (whichever is enabled). Or, the user can preselect a specific trunk for the call. Also, the system can optionally force System Speed Dialing numbers to route over a specific Trunk Group. User preselection always overrides the system routing.

### **System Bins Limited to 1000 with Speaker Key or #2 Service Code - Version 1000 (1.00)**

Though there are 10000 Speed Dialing bins available in the system, once programmed, these bins can currently be dialed only using the Directory Dial feature (Press Directory key + ABB softkey + press ABBc/ABBg + use arrow keys to locate number or enter the Speed Dial bin name & press arrow key to locates number + Speaker to place call.)



NOTE

*Speaker and service code #2 operations are not available for any 4-digit Speed Dial System bin number.*

### **DSS Console Chaining**

DSS Console chaining allows an extension user with a DSS Console to chain to a Speed Dialing number stored under a DSS Console key. The stored number dials out (chains) to the initial call. This can, for example, simplify dialing when calling a company with an Automated Attendant. You can program the bin for the company number under one DSS Console key (e.g., #200) and the client's extension number under the other (e.g., #201). The DSS Console user can press the first key to call the company, wait for the Automated Attendant to answer, then press the second key to call the client (extension 400). See the Programming section below for additional details.



NOTE

*The DSS Console user can also chain to an Speed Dialing number dialed manually, from a Programmable Function Key or a One-Touch Key.*

### Storing a Flash

To enhance compatibility with connected Centrex and PBX lines, Speed Dialing bin can have a stored Flash command. For example, storing 9 Flash 926 5400 causes the system to dial 9, flash the line and then dial 926 5400. The Flash can be stored by the user from their telephone or by the system administrator during system programming.

### Using a Programmable Function Key

To streamline frequently-called numbers, a Speed Dialing Programmable Function Key can also store a Speed Dialing bin number. When the extension user presses the key, the telephone automatically dials out the stored number. This provides true one-touch calling via a telephone function keys.

### Cursor Key Operation

By pressing the Right Cursor key, the user can access all directory menus. The flow chart below shows the menu access sequence (refer to [Figure 2-84 Right Cursor Key Operation Flow Chart on page 2-1464](#)). If the terminal is not allowed access to Speed Dial and/or Telephone Book numbers or no telephone numbers are programmed in those areas, they are skipped.

Figure 2-84 Right Cursor Key Operation Flow Chart

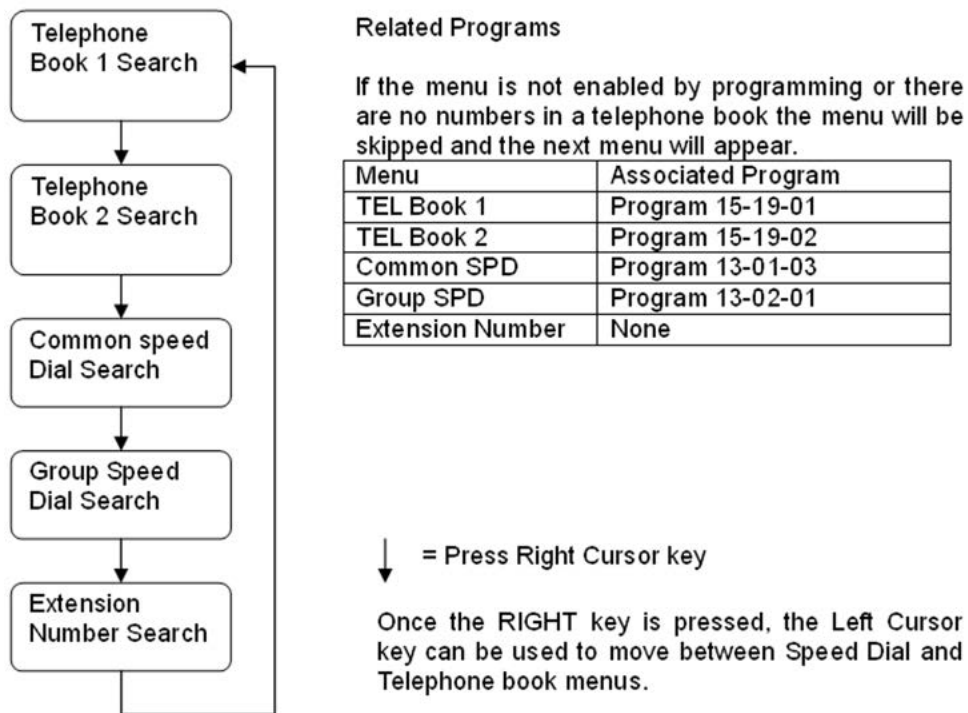

## Enhancements

- With **Version 2000 (2.00 or higher)** Speaker and service code #2 or #4 operations are now available for any 4-digit Speed Dial System/Group bin number depending on new Program 13-01-05.

## Conditions

- The following priorities are used when determining what information to display for inbound CO calls with Caller ID information:
  1. Fixed Telco messages: "OUT OF AREA", "PRIVATE" or "PAY PHONE".
  2. Memo display settings for speed dial buffer in Program 13-04-08, 13-04-09 or 13-04-10.
  3. Calling party name provided by Telco.
  4. Abbreviated Dial Name stored in Program 13-04-02 for an inbound call with Caller ID number only.
- Speed Dial bins can contain stored Account Codes. To prevent them from being displayed use Program 35-05-04.
- ARS selects the trunk for the call unless the user preselects.
- A user can implement Speed Dial only if their extension has outgoing access to trunks.
- An extension can have a One-Touch Key for Speed Dial operation.
- If you enter a PBX trunk access code in a Speed Dial bin, the system automatically inserts a pause after the bin.
- Single line telephones can dial only System and Group Speed Dial numbers.
- Toll Restriction may prevent a user from using a stored Speed Dial number.
- Unless a user preselects a trunk, Trunk Group Routing selects the trunk Speed Dial uses for trunk calls.
- If the Speed Dial bin does not have a name assigned, it does not show when scrolling through the directory of speed dials.
- If Program 13-01-01 is set to 1 (Intercom Access mode), system speed dial bins require inserting a trunk access code.
- When operating the Right Cursor key, if the menu is not enabled by programming or there are no numbers in a telephone book, the menu is skipped and the next menu will appear.
- For DT3XX or DT7XX terminals, use the Feature Key to clear the characters one at a time when entering the name.
- The priority for the Large LED color for incoming calls is Programs 13-04-13, then 14-01-35 or 15-23-01.

## Default Settings

Available (No Speed Dialing bins are assigned).

## System Availability

### Terminals

All Terminals

### Required Component(s)

None

## Related Features

- ➔ **Account Code Entry**
- ➔ **Automatic Route Selection (ARS)**
- ➔ **Central Office Calls, Placing**
- ➔ **Code Restriction**
- ➔ **Dial Tone Detection**
- ➔ **One-Touch Calling**
- ➔ **PBX Compatibility**
- ➔ **Programmable Function Keys**
- ➔ **Single Line Telephones, Analog 500/2500 Sets**
- ➔ **Trunk Group Routing**

## Guide to Feature Programming

The **Level 1**, **Level 2** and **Level 3** columns indicate the programs that are assigned when programming this feature in the order they are most commonly used. These levels are used with PCPro and WebPro wizards for feature programming.

- Level 1 – these are the most commonly assigned programs for this feature.
- Level 2 – these are the next most commonly assigned programs for this feature.
- Level 3 – these programs are not often assigned and require an expert level working knowledge of the system to be properly assigned.

Program Number	Program Name/Description	Input Data	Default	Level		
				1	2	3
10-09-01	<b>DTMF and Dial Tone Circuit Setup</b> If dial tone detection is enabled, allocate at least one circuit for dial tone detection (Type 0 or 2).	0 = Common Use 1 = Extension Only 2 = Trunk Only	Circuit/Resource 01 ~ 08 = 1 (Extensions) Circuit/Resource 09 ~ 32 = 2 (Trunks) Circuit/Resource 33 ~ 144 = 0 (Common) When GPZ-BS10 is installed, 81 ~ 144 are available		✓	
11-10-04	<b>Service Code Setup (for System Administrator) – Storing Common Speed Dialing Numbers</b> Customize the service code used for storing Common Speed Dialing Numbers	MLT 0 ~ 9, *, # Maximum of eight digits	753		✓	
11-10-05	<b>Service Code Setup (for System Administrator) – Storing Group Speed Dialing Numbers</b> Customize the service code used for storing group speed dialing numbers.	MLT 0 ~ 9, *, # Maximum of eight digits	754		✓	
11-11-39	<b>Service Code Setup (for Setup/Entry Operation) – Station Speed Dial Number Entry</b> Customize the service code used for entering station speed dial numbers.	MLT, SLT 0 ~ 9, *, # Maximum of eight digits	755		✓	
11-12-10	<b>Service Code Setup (for Service Access) – Station Speed Dialing</b> Assign Service code used for accessing System Speed Dial bins (default #2).	MLT, SLT 0 ~ 9, *, # Maximum of eight digits	#2		✓	
11-12-11	<b>Service Code Setup (for Service Access) – Group Speed Dialing</b> Customize the service code used for group speed dialing.	MLT, SLT 0 ~ 9, *, # Maximum of eight digits	#4		✓	

Program Number	Program Name/Description	Input Data	Default	Level		
				1	2	3
13-01-01	<b>Speed Dialing Function Setup – Speed Dialing Auto Outgoing Call Mode</b> Designate trunk or intercom outgoing mode.	0 = Trunk Outgoing Mode 1 = Intercom Outgoing Mode	0		✓	
13-01-03	<b>Speed Dialing Function Setup – Number of Common Speed Dialing Bins</b> Designate the bins the system uses for System Speed Dialing.	0 ~ 10000 0 = No Common Speed Dialing	1000		✓	
13-01-05	<b>Speed Dialing Function Setup – Speed Dial Digits Expansion</b> If set to 0 speed dial digits are three. If set to 1 speed dial digits are four. ➡ <i>Version 2000 (2.00 or higher required)</i>	0 = Not Expand 1 = Expand	0		✓	
13-02-01	<b>Group Speed Dialing Bins</b> Designate the starting and ending bin numbers the system uses for Group Speed Dialing.	01 ~ 64 0 ~ 9999 Starting bin number range: 0 ~ 9990 Ending bin number range: 0 ~ 9999	No Setting		✓	
13-03-01	<b>Speed Dialing Group Assignment for Extensions</b> For Group Speed Dialing, assign extensions to Speed Dialing groups.	01 ~ 64	1		✓	
13-04-01	<b>Speed Dialing Number and Name – Speed Dialing Data</b> Enter the System and Group Speed Dialing numbers and names.	Maximum of 24 digits. 1 ~ 9, 0, *, # Pause (Press line key 1) Recall/Flash (Press line key 2) @ = Code to wait for answer supervision in ISDN (Press line key 3)	No Setting	✓		
13-04-02	<b>Speed Dialing Number and Name – Name</b> Assign a name to each System Speed Dial bin.	Maximum of 12 characters (Use dial pad to enter name)	No Setting	✓		
13-04-03	<b>Speed Dialing Number and Name – Transfer Mode</b> When the incoming caller ID matches the number programmed in the speed dial bin, this setting determines the destination of the call.	0 = Not Used 1 = Internal Dial 2 = Incoming Ring Group (IRG)	0		✓	
13-04-04	<b>Speed Dialing Number and Name – Transfer Destination Number</b> When the incoming caller ID matches the number programmed in the speed dial bin, this setting determines the destination of the call.	If Transfer mode is (Refer to Program 13-04-03): 1 = Internal Dial Mode 1 ~ 9, 0, *, #, P, R, @ (Maximum 24 Characters) 2 = Incoming Ring Group 0 ~ 100 (IRG Number) P = Pause R = Recall @ = Additional Digits when using ISDN functionality	No Setting		✓	



Program Number	Program Name/Description	Input Data	Default	Level		
				1	2	3
13-04-05	<b>Speed Dialing Number and Name – Incoming Ring Pattern</b> Define the ring tone for the caller ID routed call.	Incoming Ring Pattern 0 = Normal Pattern 1 ~ 4 = Tone Pattern (1 ~ 4) 5 ~ 9 = Scale Pattern (1 ~ 5) 10 ~ 13 = Tone Pattern (5 ~ 8)	0		✓	
13-04-13	<b>Speed Dialing Number and Name – Large LED Illumination Setup by (CID)</b> Define the color the large LED will blink when Incoming call with matching Caller ID is received.	1 = Not used 2 = Red 3 = Green 4 = Blue 5 = Yellow 6 = Purple 7 = Light Blue 8 = White 9 = Rotation 0 = No Setting	No Setting		✓	
13-05-01	<b>Speed Dialing Trunk Group – Trunk Group Number</b> For each System Speed Dialing number, enter the routing option Trunk Group Number (1 ~ 100) to dial out on.	0 = No setting 1 ~ 100	0		✓	
14-02-06	<b>Analog Trunk Data Setup – Pause at 1st digit after Line Seize in Manual Dial Mode</b> Enable/Disable the system ability to pause after dialing the first digit.	0 = No Pause (No) 1 = Pause (Yes)	1		✓	
15-02-04	<b>Multiline Telephone Basic Data setup – Redial (Speed Dial) Control</b> Assign the extension Redial key for either Common or Group Speed Dialing.	0 = Common and Individual Speed Dialing 1 = Group Speed Dialing	0		✓	
15-07-01	<b>Programmable Function Keys</b> Assign a function key for System Speed Dialing (27) or Group Speed Dialing (28). You can program the key as either a general Speed Dialing key or you can choose to store a bin number with the function key. This key then always dials the associated bin number. If storing a bin number along with the code, do not store 0, 00 or 000. To bypass entering a bin number, press <b>Hold</b> ( <b>Hold</b> is also required if programming the function key using the service code 751).	Line Key 1 ~ 48 0 ~ 99 (Normal Function Code 751 by default) *00 ~ *99 (Appearance Function Code) (Service Code 752 by default)	Refer to the Programming Manual for default values.		✓	
15-14-01	<b>Programmable One-Touch Keys – Station Speed Dial Data</b> Assign the extensions Speed Dial number (1 ~ 10).	Maximum of 24 digits. 1~0, *, #, Pause, Hookflash, @ (Code for Answer-Wait)	No Setting	✓		
15-14-02	<b>Programmable One-Touch Keys – Station Speed Dial Name</b> Assign the name associated with the extension Speed Dial Bin (1 ~ 10).	Name	No Setting	✓		

Program Number	Program Name/Description	Input Data	Default	Level		
				1	2	3
20-06-01	<b>Class of Service for Extensions</b> Assign a Class of Service (1 ~ 15) to an extension.	Day Night/Mode: 1 ~ 8 Class of Service of Extensions (1 ~ 15)	Extension port 101 = Class 15 All other extension port = Class 1		✓	
20-07-04	<b>Class of Service Options (Administrator Level) – Storing Speed Dialing Entries</b> Turn Off or On an extension user ability to store System or Group Speed Dialing numbers.	0 = Off 1 = On	COS 1 ~ 15 = 1		✓	
20-08-03	<b>COS Options (Outgoing Call Service) – System Speed Dialing</b> Turn Off or On an extension user ability to make outbound calls using system speed dial numbers.	0 = Off 1 = On	COS 1 ~ 15 = 1		✓	
20-08-04	<b>COS Options (Outgoing Call Service) – Group Speed Dialing</b> Turn Off or On an extension user ability to make outbound calls using group speed dial numbers.	0 = Off 1 = On	COS 1 ~ 15 = 1		✓	
30-03-01	<b>DSS Console Key Assignment</b> For DSS Console Chaining, assign an Speed Dialing Service Code (or) plus a 2-digit bin number to a DSS Console key.	Key Number 001 ~ 114 0 ~ 99 (General Functional Level) 97 = Door Box Access key (additional data: 1 ~ 8 Door Box No.) * 00 ~ * 99 (Appearance Functional Level)	Refer to the Programming Manual for default values.		✓	
80-03-01	<b>DTMF Tone Receiver Setup – Detect Level</b> Define the detect levels for the DTMF Tone Receiver.	0 = 0dBm ~ -25dBm 1 = -5dBm ~ -30dBm 2 = -10dBm ~ -35dBm 3 = -15dBm ~ -40dBm 4 = -20dBm ~ -45dBm 5 = -25dBm ~ -50dBm 6 = -30dBm ~ -55dBm	Type 1 ~ 5 = 0			✓
80-03-02	<b>DTMF Tone Receiver Setup – Start delay time</b> Define the start delay times for the DTMF Tone Receiver.	0 ~ 255 (0.25ms ~ 64ms)	Type 1 ~ 5 = 0			✓

Program Number	Program Name/Description	Input Data	Default	Level		
				1	2	3
80-03-03	<p><b>DTMF Tone Receiver Setup – Min. detect level</b></p> <p>Define the minimum detect levels for the DTMF Tone Receiver.</p>	<p>0 ~ 15</p> <p>detect level 0: -10dBm(0) to -25dBm(15)</p> <p>detect level 1: -15dBm(0) to -30dBm(15)</p> <p>detect level 2: -20dBm(0) to -35dBm(15)</p> <p>detect level 3: -25dBm(0) to -40dBm(15)</p> <p>detect level 4: -30dBm(0) to -45dBm(15)</p> <p>detect level 5: -35dBm(0) to -50dBm(15)</p> <p>detect level 6: -40dBm(0) to -55dBm(15)</p> <p>detect level 7: -45dBm(0) to -60dBm(15)</p> <p>detect level 8: -50dBm(0) to -65dBm(15)</p> <p>detect level 9: -55dBm(0) to -70dBm(15)</p> <p>detect level 10: -60dBm(0) to -75dBm(15)</p> <p>detect level 11: -65dBm(0) to -80dBm(15)</p> <p>detect level 12: -70dBm(0) to -85dBm(15)</p> <p>detect level 13: -75dBm(0) to -90dBm(15)</p> <p>detect level 14: -80dBm(0) to -95dBm(15)</p> <p>detect level 15: -85dBm(0) to -100dBm(15)</p>	<p>Type 1 = 10 (-20dBm)</p> <p>Type 2~3 = 15 (-25dBm)</p> <p>Type 4~5 = 10 (-20dBm)</p>			✓

Program Number	Program Name/Description	Input Data	Default	Level		
				1	2	3
80-03-04	<b>DTMF Tone Receiver Setup – Max. detect level</b> Define the maximum detect levels for the DTMF Tone Receiver.	0 ~ 15 detect level 0: 0dBm(0) to -15dBm(15) detect level 1: -5dBm(0) to -20dBm(15) detect level 2: -10dBm(0) to -25dBm(15) detect level 3: -15dBm(0) to -30dBm(15) detect level 4: -20dBm(0) to -35dBm(15) detect level 5: -25dBm(0) to -40dBm(15) detect level 6: -30dBm(0) to -45dBm(15) detect level 7: -35dBm(0) to -50dBm(15) detect level 8: -40dBm(0) to -55dBm(15) detect level 9: -45dBm(0) to -60dBm(15) detect level 10: -50dBm(0) to -65dBm(15) detect level 11: -55dBm(0) to -70dBm(15) detect level 12: -60dBm(0) to -75dBm(15) detect level 13: -65dBm(0) to -80dBm(15) detect level 14: -70dBm(0) to -85dBm(15) detect level 15: -75dBm(0) to -90dBm(15)	Type 1 ~ 5 = 2 (-2dBm)			✓
80-03-05	<b>DTMF Tone Receiver Setup – Forward twist level</b> Define the forward twist levels for the DTMF Tone Receiver.	0 ~ 9 (1dB ~ 10dB)	Type 1~5 = 5 (6dBm)			✓
80-03-06	<b>DTMF Tone Receiver Setup – Backward twist level</b> Define the backward twist levels for the DTMF Tone Receiver.	0 ~ 9 (1dB ~ 10dB)	Type 1~5 = 0 (1dBm)			✓

Program Number	Program Name/Description	Input Data	Default	Level		
				1	2	3
80-03-07	<b>DTMF Tone Receiver Setup – ON detect time</b> Define the on detect times for the DTMF Tone Receiver.	1 ~ 255 (15+ 15ms ~ 3825ms)	<b>Version 1000</b> Type 1 ~ 5 = 1 (30ms)			✓
			<b>Version 3000 or higher</b> Type 1 ~ 5 = 3 (60ms)			
80-03-08	<b>DTMF Tone Receiver Setup – OFF detect time</b> Define the off detect timer for the DTMF Tone Receiver.	1 ~ 255 (15+ 15ms ~ 3825ms)	<b>Version 1000</b> Type 1 ~ 5 = 1 (30ms)			✓
			<b>Version 3000 or higher</b> Type 1 ~ 5 = 2 (45ms)			
80-04-01	<b>Call Progress Tone Detector Setup – Detection Level</b> Define the detection levels for the Call Progress Tone Detector.	0 = 0dBm ~ -25dBm 1 = -5dBm ~ -30dBm 2 = -10dBm ~ -35dBm 3 = -15dBm ~ -40dBm 4 = -20dBm ~ -45dBm 5 = -25dBm ~ -50dBm 6 = -30dBm ~ -55dBm	Type 1 (DT) – 0 (-25dBm) Type 2 (BT) – 0 (-25dBm) Type 3 (RBT) – 0 (-25dBm) Type 4, Type 5 – 0			✓
80-04-02	<b>Call Progress Tone Detector Setup – Min. Detection Level</b> Define the minimum detection levels for the Call Progress Tone Detector.	0 ~ 15 detect level 0: -15dBm (0) to -30dBm(15) detect level 1: -30dBm (0) to -45dBm(15) detect level 2: -40dBm (0) to -55dBm(15)	<b>Version 1000</b> Type 1 (DT) – 15 (-25dBm) Type 2 (BT) – 15 (-25dBm) Type 3 (RBT) – 15 (-25dBm) Type 4, Type 5 – 0			✓
			<b>Version 3000 or higher</b> Type 1 (DT) – 15 (-25dBm) Type 2 (BT) – 15 (-25dBm) Type 3 (RBT) – 15 (-25dBm) Type 4 – 0 Type 5 – 1			

Program Number	Program Name/Description	Input Data	Default	Level		
				1	2	3
80-04-03	<p><b>Call Progress Tone Detector Setup – S/N Ratio</b></p> <p>Define the S/N ratio for the Call Progress Tone Detector.</p>	0 ~ 4 (0dB ~ -20dB)	Type 1 (DT) – 4 (-20dB) Type 2 (BT) – 4 (-20dB) Type 3 (RBT) – 4 (-20dB) Type 4, Type 5 – 0			✓
80-04-04	<p><b>Call Progress Tone Detector Setup – No tone time</b></p> <p>Define the no tone time for the Call Progress Tone Detector.</p>	0 ~ 255 (30 + 30 ~ 7680ms) (0 = not detect) 1 ~ 255 = 60 ~ 7680ms The formula is 30 + 30N. When set to N = 1, it means 30 + 30 * 1 = 60. When set to N=255, it means 30+30*255=7680	Type 1 (DT) – 132 (3990ms) Type 2 (BT) – 132 (3990ms) Type 3 (RBT) – 132 (3990ms) Type 4, Type 5 – 0			✓
80-04-05	<p><b>Call Progress Tone Detector Setup – Pulse Count</b></p> <p>Define the pulse count for the Call Progress Tone Detector.</p>	1 ~ 255	Type 1 (DT) – 1 Type 2 (BT) – 1 Type 3 (RBT) – 1 Type 4, Type 5 – 0			✓
80-04-06	<p><b>Call Progress Tone Detector Setup – ON minimum time</b></p> <p>Define the on minimum time for the Call Progress Tone Detector.</p>	1 ~ 255 (30 + 30 ~ 7680ms)	<p><b>Version 1000</b></p> Type 1 (DT) – 9 (300ms) Type 2 (BT) – 12 (300ms) Type 3 (RBT) – 25 (780ms) Type 4, Type 5 – 0  <p><b>Version 3000 or higher</b></p> Type 1 (DT) – 45 (300ms) Type 2 (BT) – 12 (300ms) Type 3 (RBT) – 25 (780ms) Type 4 – 0 Type 5 – 5			✓

Program Number	Program Name/Description	Input Data	Default	Level		
				1	2	3
80-04-07	<b>Call Progress Tone Detector Setup – ON maximum time</b> Define the on maximum time for the Call Progress Tone Detector.	0 ~ 255 (30+30-7680ms)	<b>Version 1000</b> Type 1 (DT) – 0 Type 2 (BT) – 20 (630ms) [ET] Type 3 (RBT) – 40 1230ms Type 4, Type 5 – 0			
			<b>Version 3000 or higher</b> Type 1 (DT) – 0 Type 2 (BT) – 20 (630ms) [ET] Type 3 (RBT) – 40 1230ms Type 4 – 0 Type 5 – 15			✓
80-04-08	<b>Call Progress Tone Detector Setup – OFF minimum time</b> Define the off minimum time for the Call Progress Tone Detector.	1 ~ 255 (30+30-7680ms)	Type 1 (DT) – 1 (60ms) Type 2 (BT) – 12 (300ms) Type 3 (RBT) – 83 (2520ms) Type 4, Type 5 – 0			✓
80-04-09	<b>Call Progress Tone Detector Setup – OFF maximum time</b> Define the off maximum time for the Call Progress Tone Detector.	0 ~ 255 (30+30-7680ms)	Type 1 (DT) – 1 (60ms) Type 2 (BT) – 20 (450ms) Type 3 (RBT) – 115 (3480ms) Type 4, Type 5 – 0			✓

## Operation

### To store an Speed Dialing number (display telephones only):

1. Press **Speaker**.
2. Dial **753** (for system) or **754** (for group).
3. Dial system or group storage code.
  - ◇ *Initially, there are 1000 System Speed Dialing codes. There are Group Speed Dialing codes only if you define them in programming.*

4. Dial telephone number you want to store (up to 24 digits).
  - ◇ Valid entries are 0~9, # and \*. To enter a pause, press Transfer. To store a Flash, press Recall.
  - ◇ Enter @ for await answer before sending following digits on ISDN.
5. Press **Hold**.
6. Enter the name associated with the Speed Dialing number.

Table 2-108 Keys for Entering Names

Use this keypad digit . . .	When you want to . . .
1	Enter characters: 1 @ [ ¥ ] ^ _ ` {   } Æ " Á À Â Ã Ç É Ê ì ó
2	Enter characters: <b>A-C, a-c, 2.</b>
3	Enter characters: <b>D-F, d-f, 3.</b>
4	Enter characters: <b>G-I, g-i, 4.</b>
5	Enter characters: <b>J-L, j-l, 5.</b>
6	Enter characters: <b>M-O, m-o, 6.</b>
7	Enter characters: <b>P-S, p-s, 7.</b>
8	Enter characters: <b>T-V, t-v, 8.</b>
9	Enter characters: <b>W-Z, w-z, 9.</b>
0	Enter characters: 0 ! “ # \$ % & ’ ( ) ô Õ ú ä ö ü α ε θ
*	Enter characters: * + , - . / : ; < = > ? π Σ σ Ω ∞ € £
#	# = Accepts an entry (only required if two letters on the same key are needed - ex: TOM). Pressing # again = Space. (In system programming mode, use the right arrow Softkey instead to accept and/or add a space.)
<b>Feature</b>	Clear the character entry one character at a time.
<b>HOLD (Telpro only)</b>	Clear all the entries from the point of the flashing cursor and to the right.

7. Press **Hold**.
8. Press **Speaker** to hang up or repeat steps 3~7 to program another System or Group Speed Dial bin.

**To dial a System Speed Dialing number:**

1. Go off-hook.
  2. Press **Redial**.
- OR -



Press the **Right Cursor** key until the Group Speed Dial menu appears.

3. Dial the System Speed Dialing storage code.
  - ◇ *Unless you preselect, Trunk Group Routing selects the trunk for the call. The system may optionally select a specific Trunk Group for the call.*
  - ◇ *If you have a DSS Console, you may be able to press a DSS Console key to chain to a stored number.*

**To store a System Speed Dialing number under a Programmable Function Key:**

1. At multiline terminal, press **Speaker**.
2. Dial **751**.
3. Press the key where the number is to be stored.
4. Dial **27**.
5. Dial System Speed Dial Bin number to put under the key.
6. Press **Speaker** to hang up.

**To dial a System Speed Dialing number under a Programmable Function Key:**

1. At the multiline terminal, press **Speaker**.
2. Press the key, which has the stored number to be dialed.
  - ◇ *The number seizes an outside line and dials out.*

**To dial a Group Speed Dialing number:**

1. Go off-hook.
2. Press **Redial**.

- OR -

Press the **Right Cursor** key until the Group Speed Dial menu appears.

- OR -

Press the **Group Speed Dialing** key (Program 15-07-01 or SC 751: 28).

- ◇ *To preselect, press a line key in step 1 (instead of **Speaker**) before pressing **Redial** or **Speed Dialing** key.*
3. Dial the Group Speed Dialing code.
    - ◇ *The stored number dials out.*
    - ◇ *Unless you preselect, Trunk Group Routing selects the trunk for the call.*
    - ◇ *If you have a DSS Console, you may be able to press a DSS Console key to chain to a stored number.*

**To check your stored Speed Dialing numbers (display telephone only):**

1. Press the **Help** key.

2. For System Speed Dialing, press **Redial**.  
Dial the Speed Dialing Code (e.g., common code **001**).  
◇ *If the entire stored number is too long for your telephone display, press \* to see the rest of the number.*  
- OR -  
For Group Speed Dialing, press the **Group Speed Dialing** key.  
- OR -  
For System Speed Dialing key, press the **System Speed Dialing** key.
3. Press the **Exit** key.  
◇ *To display additional numbers, repeat from step 1.*  
- OR -  
Press the **Right Cursor** key until the appropriate Telephone Book, System or Group Speed Dial menu appears.  
◇ *Use the Volume "Down" and Volume "Up" keys to scroll through the stored numbers.*

#### To store a Station Speed Dialing number (display telephones only):

1. Press **Speaker**.
2. Dial **755**.
3. Dial the Station Speed Dial buffer number to be programmed (**0~9**).  
1 = Station Speed Dial buffer 1  
2 = Station Speed Dial buffer 2  
" " " " " "  
0 = Station Speed Dial buffer 10
4. Dial the telephone number you want to store (up to 24 digits).  
◇ *Valid entries are 0~9, # and \*. To enter a pause, press MIC. To store a Flash, press Recall.*
5. Press **Hold**.
6. Enter the name associated with the Speed Dialing number (display telephones only). Refer to [Table 2-108 Keys for Entering Names on page 2-1476](#).
7. Press **Hold**.
8. Press **Speaker** to hang up.

#### To store a Station Speed Dialing number (Single Line Telephones only):

1. Lift the Handset.
2. Dial **755**.
3. Dial the Station Speed Dial buffer number to be programmed (0~9).  
1 = Station Speed Dial Buffer 1  
2 = Station Speed Dial Buffer 2  
3 = Station Speed Dial Buffer 3

- 4 = Station Speed Dial Buffer 4
- 5 = Station Speed Dial Buffer 5
- 6 = Station Speed Dial Buffer 6
- 7 = Station Speed Dial Buffer 7
- 8 = Station Speed Dial Buffer 8
- 9 = Station Speed Dial Buffer 9
- 0 = Station Speed Dial Buffer 10

4. Dial the telephone number you want to store (up to 24 digits).
  - ◇ *Valid entries are 0~9, # and \*.*
  - ◇ *A Single line set cannot program a pause or flash in a spd bin.*
5. Hang up.

**To dial a Station Speed Dialing number (multiline terminal):**

1. Press **Speaker**.
2. Dial **#7** (default Service Code).
3. Dial the Station Speed Dial buffer number (**0 ~9**).
  - 1 = Station Speed Dial buffer 1
  - 2 = Station Speed Dial buffer 2
  - : : : : :
  - 0 = Station Speed Dial buffer 10
  - ◇ *The stored number dials out.*
  - ◇ *Unless you preselect, Trunk Group Routing selects the trunk for the call. The system may optionally select a specific Trunk Group for the call.*
  - ◇ *If you have a DSS Console, you may be able to press a DSS Console key to chain to a stored number.*

**To dial a Station Speed Dialing number (Single Line Telephone):**

1. Lift the Handset.
2. Station Speed Dial **#7**  
 Group Speed Dial **#4**  
 System Speed Dial **#2**
3. Dial the Speed Dial Memory Location.  
 Station Speed Dial **0~9**  
 Group Speed Dial **xxx** (none at default)  
 System Speed Dial **000~9999**
4. Converse.

# Speed Dial – Telephone Book

## Description

Speed Dial – Telephone Book is a part of the Speed Dialing system. A maximum of 200 Telephone Books are supported per system. Individual extensions can be assigned up to two Telephone Books. Each Telephone Book can contain up to 450 alphabetical entries. Each of the 200 Telephone Books can have the 450 entries separated into 40 different Telephone Book Groups providing a quicker search capability to the user.

For example, Telephone Book 1 represents equipment manufacturer ABC Corporation. The ABC Corporation is divided into three groups; Sales, Service, and Parts. When a user needs to search the ABC Corporation Telephone Book for a Sales number, the search from all 450 entries in the ABC Corporation Telephone Book can be narrowed to the entries in the Sales Group only.

### Conditions

- A maximum of 200 Telephone Books is supported.
- Each extension in the SV9100 can be assigned two different Telephone books.
- Each Telephone Book can contain 40 different Telephone Book Groups.

### Default Settings

Disabled

## System Availability

### Terminals

DT300 and DT700 terminals

### Required Component(s)

None

## Related Features

➔ [Speed Dial – System/Group/Station](#)

## Guide to Feature Programming

The **Level 1**, **Level 2** and **Level 3** columns indicate the programs that are assigned when programming this feature in the order they are most commonly used. These levels are used with PCPro and WebPro wizards for feature programming.

- ❑ Level 1 – these are the most commonly assigned programs for this feature.
- ❑ Level 2 – these are the next most commonly assigned programs for this feature.
- ❑ Level 3 – these programs are not often assigned and require an expert level working knowledge of the system to be properly assigned.

Program Number	Program Name/Description	Input Data	Default	Level		
				1	2	3
11-11-56	<p><b>Service Code Setup (for Setup/Entry Operation) – Telephone Book Lock Service</b>                      Password to unlock telephone book.</p> <ul style="list-style-type: none"> <li>○ Dial the service code to lock the telephone book (Program 11-11-56), then it prompts you for an extension number to unlock. Type in the ext number you want to unlock then you will be prompted for the password. Type in the password and then the telephone book is unlocked. When you dial the password to unlock the telephone book it removes the entry in 15-19-06 so the book is not locked anymore.</li> <li>○ To lock the telephone book do the same steps as above when the book is already unlocked. It will then assign 15-19-06 for you.</li> </ul>	MLT 0 ~ 9, *, # Maximum of eight digits	No Setting	✓		
13-07-01	<p><b>Telephone Book Dial Number and Name – Speed Dialing Data</b>                      Assign telephone numbers to entries in each book. There are 200 books with 450 entries (0-449) in each book.</p>	Maximum of 24 digits 1~9, 0, *, #, Pause (Press line key 1), Recall/Flash (Press line key 2), @ = Code to wait for answer supervision in ISDN (Press line key 3)	No Setting	✓		
13-07-02	<p><b>Telephone Book Dial Number and Name – Name</b>                      Assign a name to each telephone number.</p>	Maximum of 12 digits (Use dial pad to enter name)	No Setting	✓		
13-07-04	<p><b>Telephone Book Dial Number and Name – Group Number</b>                      Assign each entry in the telephone book to a group if needed.</p> <ul style="list-style-type: none"> <li>➤ <i>In the telephone book you can break it down further and have specific groups to search on. For example, you could have sales, support, personal, finance, etc. groups to narrow your search.</i></li> <li>➤ <i>A name and number can be assigned to an entry and each entry can be assigned to a group.</i></li> </ul>	1 ~ 40	1	✓		

Program Number	Program Name/Description	Input Data	Default	Level		
				1	2	3
13-08-01	<b>Telephone Book System Name – Telephone Book Name</b> Assign a name to all 100 telephone books.	Maximum of six characters.	No Setting	✓		
13-09-01	<b>Telephone Book Group Name – Group Name</b> Assign a name to all 40 telephone book groups per telephone book (1-200).	Maximum of 12 characters.	1 = Group 01 2 = Group 02 3 = Group 03 : : : 40 = Group 40	✓		
13-10-01	<b>Telephone Book Routing – Outgoing Mode</b> Assign a trunk or ICM per telephone book (1-100). ➡ <i>If set to trunk, it follows the stations trunk group routing and you do not enter the trunk access code in the entries. If set to ICM, you must enter the trunk access code in front of the number and it will follow the trunk access code for routing.</i>	0 = Trunk Outgoing 1 = Intercom Outgoing	0	✓		
15-19-01	<b>System Telephone Book Setup for Extension – Telephone Book 1</b> Assign a station to the first telephone book. A station can have a maximum of two telephone books assigned.	Maximum of eight digits 0 ~ 200	Port 1 : 1 Port 2 : 2 : : Port 200 : 200	✓		
15-19-02	<b>System Telephone Book Setup for Extension – Telephone Book 2</b> Assign a station to the second telephone book. A station can have a maximum of two telephone books assigned.	Maximum of eight digits 0 ~ 200	0	✓		
15-19-06	<b>System Telephone Book Setup for Extension – Locking of Telephone Book</b> Allows the book to be locked/unlocked. When locked, the password must be dialed to unlock the book or it can be removed via programming.	0 = Off 1 = On	0	✓		
15-19-07	<b>System Telephone Book Setup for Extension – Password</b> Allows you to lock/unlock the telephone book per extension.	0000 ~ 9999 (Fixed four digits)	0000	✓		

## Operation

### To search for an entry in the Telephone Book:

1. Press the **DIR** softkey.
2. Press the **TELBK** softkey.
3. Press the softkey associated with the first or second book.

- OR -

Press the **Right** cursor key.

4. After selecting the book, choose one of the following search types.
  - ◇ *To scroll the entries in the book, press Up or Down on the cursor pad. Once you reach the last entry on the page, the display advances to the next page. To select one of the entries, press the associated number on the dial pad or the center cursor pad button.*

#### Search By Name

Type as many letters as you want used for the search. If searching for an entry labeled “Paul”, type “P”. A page listing all entries beginning with the letter “P” is displayed. Or, you could type “Paul” and it would display “Paul”. After typing the search criteria, press the down pad to initiate the search.

#### Search By Number

Press the **NUM** softkey. Now you can do the same search as above but using a telephone number instead of a name. If searching for a number beginning with “1”, type “1”. A page listing all entries beginning with the number “1” is displayed. Or, you could type part of all of the telephone number “817” and it would display all telephone numbers beginning the “817”. After typing the search criteria, press the down pad to initiate the search.

#### Search Using Softkey

Press the **Menu** softkey and choose one of the following search types.

- Select the **NAME** softkey to search by name. Use the same search criteria explained in the “Search by Name” section.
  - Select the **GRP** softkey to search by groups within that phone book. Use the Up/Down arrow to search through groups (1~40). Select the group you want to search and press the center cursor pad button. All the entries in the group are selected, press the Up/Down arrows to scroll through all entries in the group.
  - Select the **NUM** softkey to search by number. Use the same search criteria explained in the “Search by Number” section.
  - Select the **MEM** softkey to search by registry memory area (0~449). Type in the registry memory area (0-449) to jump to that entry.
5. Once you have found entry, proceed to the change, delete or dial entry operation.

### To change entries in the Telephone Book:

1. Press the **DIR** softkey.

2. Press the **TELBK** softkey.
3. Press the softkey associated with the first or second book.  
- OR -  
Press the **Right** cursor key.
4. Search to select the telephone name, telephone number or registry memory area (0~449) to change. The selected entry flashes.
5. Press **OK** (center cursor key).
6. Press the **CHG** softkey. The selected entry flashes.
7. Press the center button on the cursor pad.
8. If you want to change the **Telephone Book Entry Name**, type the new name using the telephone dial pad keys and press the center button on the cursor pad. To accept the name change, press the center button on the cursor pad again. If you do not want to change the **Telephone Book Entry Name**, press the center button on the cursor pad again. The group is displayed.

If you want to change the **Group Name** type the new name using the telephone dial pad keys and press the center button on the cursor pad. To accept the name change, press the center button on the cursor pad again. If you do not want to change the **Group Name**, press the center button on the cursor pad again. The phone number is displayed.

If you want to change the **Telephone Number** type the new number using the telephone dial pad keys and press the center button on the cursor pad. To accept the number change, press the center button on the cursor pad again. If you do not want to change the **Telephone Number**, press the center button on the cursor pad again. The registry memory is displayed.

If you want to change the **Registry Memory Area** (0~449) type the new number using the telephone dial pad keys and press the center button on the cursor pad. To accept the number change, press the center button on the cursor pad again. If you do not want to change the **Registry Memory Area**, press the center button on the cursor pad again. The registry memory area is displayed. If you select a field that is already used, you have the option to overwrite that field (the old entry will be deleted). If you do not want to overwrite it press **NO**, if you do press **YES**. If you selected a memory area that was not assigned, all the entries that you made to the new memory area are assigned and you are returned to the speed dial entry selection window.

#### To delete entries in the Telephone Book:

1. Press the **DIR** softkey.
2. Press the **TELBK** softkey.
3. Press the softkey associated with the first or second book.  
- OR -  
Press the **Right** cursor key.
4. Search to select the telephone name, telephone number or registry entry (0~449) to be deleted.



The selected entry flashes.

5. Press **OK** (center cursor key).
6. If you want to delete the entry, press the **YES** softkey. If you do not want to delete the entry, press the **NO** softkey.

#### To dial entries in the Telephone Book:

1. Press the **DIR** softkey.
2. Press the **TELBK** softkey.
3. Press the softkey associated with the first or second book.

- OR -

Press the **Right** cursor key.

4. Search to select the telephone name, telephone number or registry entry (0~449) to be dialed.
5. Press the **Dial** softkey to dial the selected number.

## Description

After calling a busy extension, a call immediately hunts to the next available member of the Hunt Group (Department Group). The caller does not have to hang up and place another Intercom call if the first extension called is unavailable.

### Conditions

- If required, use this option to change the Department Step Calling Single Digit Service Code (default code = 2).
- A function key for Department Step Calling can be assigned (code 36).
- In Program 20-08-12, enable (1) or disable (0) an extension user ability to use Department Step Calling.

### Default Settings

Disabled

## System Availability

### Terminals

All Terminals

### Required Component(s)

None

## Related Features

- ➔ **Department Calling**
- ➔ **Department Step Calling**

## Guide to Feature Programming

The **Level 1**, **Level 2** and **Level 3** columns indicate the programs that are assigned when programming this feature in the order they are most commonly used. These levels are used with PCPro and WebPro wizards for feature programming.

- Level 1 – these are the most commonly assigned programs for this feature.
- Level 2 – these are the next most commonly assigned programs for this feature.
- Level 3 – these programs are not often assigned and require an expert level working knowledge of the system to be properly assigned.

Program Number	Program Name/Description	Input Data	Default	Level		
				1	2	3
16-01-03	<p><b>Department Group Basic Data Setup – Department Routing When Busy (Auto Step Call)</b></p> <p>Assign whether a call to busy station Hunts (1) or Not Hunts (0) to the next available member of the Hunt Group (Department Group).</p> <p>➔ Refer <i>Department Calling</i> on page 2-386 to set up the Department Group.</p>	<p>0 = Normal (Intercom caller to busy department member hears busy)</p> <p>1 = Circular (Intercom callers to busy department member routes to idle member)</p>	0	✓		
16-02-01	<p><b>Department Group Assignment for Extensions</b></p> <p>Set up the Department Group called by the pilot number and the extension priority when a group is called.</p> <p>Call Pickup Groups are set up in 23-02.</p>	<p>Department Groups 1 ~ 64</p> <p>Priority 1 ~ 9999</p>	<p>Default = 1 extensions in Department Group 1 with priority in port order:</p> <p>Port 1 priority = 1</p> <p>Port 256 priority = 256</p>	✓		
20-06-01	<p><b>Class of Service for Extensions</b></p> <p>Assign a Class of Service (1 ~ 15) to an extension.</p>	<p>Day Night/Mode: 1 ~ 8</p> <p>Class of Service of Extensions (1 ~ 15)</p>	<p>Extension port 101 = Class 15</p> <p>All other extension port = Class 1</p>		✓	
20-09-07	<p><b>Class of Service Options (Incoming Call Service) – Call Queuing</b></p> <p>Turn Off or On Call Queuing to the extension. Set to Off for Station Hunting to work.</p> <p>➔ Program 20-13-06 must be set to 0 (Off) for this feature to work.</p>	<p>0 = Off</p> <p>1 = On</p>	COS 1 ~ 15 = 1	✓		
20-13-06	<p><b>Class of Service Options (Supplementary Service) – Automatic Off-Hook Signaling (Automatic Override)</b></p> <p>Allow a busy extension to Manually or Automatically receive off-hook signals. Set to 0 for Station Hunting to work.</p> <p>➔ This setting is to receive incoming call signaling information during call queuing.</p>	<p>0 = Manually</p> <p>1 = Automatically</p>	COS 1 ~ 15 = 1	✓		

## Operation

### To make a Step Call:

1. Place a call to a busy extension.

## Station Message Detail Recording

### Description

Station Message Detail Recording (SMDR) provides a record of both system trunk calls and internal calls. Typically, the record outputs to a customer-provided printer, terminal or SMDR data collection device. SMDR allows you to monitor the usage at each extension and trunk. This makes charge-back and traffic management easier.

#### **SMDR provides:**

- Abandoned Call Reporting**

The SMDR report includes calls that rang into the system but were unanswered (i.e., abandoned). SMDR can include all abandoned calls or only those abandoned calls that rang longer than the specified duration. The Abandoned Call Report helps you keep track of lost business.
- Blocked Call Reporting**

When Toll Restriction blocks a call, you can have SMDR print the blocked call information. Or, you can have SMDR exclude these types of calls. With Blocked Call Reporting, you can better customize Toll Restriction for the site application.
- Customized Date Format**

The SMDR header can show the report date in one of three formats: American, European or Japanese. Set the format for your preference.
- Transferred Call Tracking**

SMDR shows each extension share of a transferred call. If an outside call is transferred among four extensions, SMDR shows how long each of the callers stayed on the call.
- Data Call Tracking**

Data Call Tracking can log the system internal data calls. Since SMDR normally logs external (trunk) data calls, Data Call Tracking lets you get a complete picture of data terminal activity.
- Digit Counting**

With Digit Counting, SMDR can selectively keep track of toll calls. For example, if the digit count is nine, SMDR does not include toll calls in the home area code. Digit Counting permits SMDR to include only the calls you want to monitor.
- Digit Masking**

Digit Masking lets you X out portions of the number dialed on the SMDR report. A digit mask of seven, for example, masks out all exchange codes (NNXs) and local addresses. Digit Masking makes it easier to keep track of calling patterns, without having to interpret each individual number. You can also use Digit Masking to block out access and security codes.
- Duration Monitoring**

SMDR can include calls of any duration, or only those that last longer than the time you specify. If you want to keep track of all trunk activity, use a short duration. To keep track of only significant usage, use a longer duration.

Extension Exclusion

You can selectively exclude extensions from the SMDR report. This ensures privacy for high-profile callers. For example, the company attorney negotiating a merger may not want his calls to show up on an in-house report.

PBX Call Reporting

If your system is behind a PBX, you can have SMDR monitor all traffic to the PBX or just calls placed over PBX trunks. The SMDR record can include all PBX calls (including calls to PBX extensions) or just calls that include the PBX trunk access code.

Trunk Exclusion

Use Trunk Exclusion to exclude certain trunks not subject to per-call charges (like WATS lines) from the SMDR report. This makes call accounting easier, since you review only those calls with variable costs.

Usage Summaries

SMDR can automatically print daily, weekly and monthly call activity summaries. Each summary includes the total number of regular trunk calls and ISDN trunk calls, and the costs for each type. The daily report prints every day at midnight. The weekly report prints every Sunday night at midnight. The monthly report prints at midnight on the last day of the month.



NOTE

*Internal SMDR is not included in the summary reports.*

Extension Name or Number

The SMDR report can include an extension name or extension number. Choose the method that makes it easier for you to track call usage.



IMPORTANT

*The LAN port only provides information through LAN-capable programs, such as HyperTerminal. Printing of the SMDR information must be done from that program.*

### Internal SMDR provides:

Answered Calls

SMDR records the calling extension and the extension number or name of who was called.

Held Calls

SMDR records the extension numbers of the party on hold and the held party. The duration of the call is recorded as the time both parties are connected until one party becomes idle. Duration Time starts when both sides are connected until one side becomes idle.

2nd Call Made While 1st is on Hold

When party A puts party B on hold and then dials party C, SMDR records the time party A and C talk until one party goes idle. If party B is picked up from hold and then either party goes idle, SMDR creates a second record for that call.

Transferred Calls

Screened Transfer – If party A calls Party B and then transfers B to party C after talking to party C, there are 2 records at this point: one for the A to B call and one for the A to C call. A third record is printed once party B or C goes idle.

Unscreened Transfer – If party A calls Party B and transfers to party C without talking to party C, there is one record at this point. A second record is printed once party B or C goes idle.

Mobile Extension

An internal call to a mobile extension generates two records:

- Internal extension to mobile extension.
- Mobile extension call to trunk call.



*The same is true for a mobile user who calls from outside the system and gets a dial tone from the mobile extension and makes an internal or trunk call.*

Conferences

If party A establishes a conference with party B and C and then drops out, a record prints for party A to B and party A to C. A 3rd record is printed when either B or C goes idle. Calls are printed in the order they leave the conference.

Virtual Extension

SMDR records the extension that the virtual extension resides on.

Answering Paging

SMDR records the extension that originated the page and the extension that answers using meet me paging.

Group Call

SMDR records the extension that answered the Department Call.

CCIS

SMDR does not support internal calls across either system.

Barge-In

SMDR does not record Barge-In.

Room Monitor

SMDR does not record Room Monitor.

Retrieving Parked Calls

SMDR prints the parked extension in the STATION column and the extension that retrieved the park in the DIALLED column.

### SMDR Enhanced for Caller ID

The SMDR output is enhanced to include up to 16 or 24 characters of the Caller ID name information (depending on the view option selected in Program 35-02-18). You can select to display the Caller ID number or name or the DID number. If you want to display the Caller Name in the DIALLED NO./CLI and ACCOUNT area, select 2 in the updated Program 35-02-15 and 1 in Program 35-02-17.

If the Caller ID name is not received, the area for Caller ID Name is blank.

### Sample SMDR Report (Trunk)

For example, with Program 35-01-08 = 0 (Format for NA), Program 35-02-14 = 1 (Date) and Program 35-02-17 = 1 (Caller ID Name), if a call is received with the Caller ID Name of NEC Infrontia Corporation (24 characters), the following SMDR record is displayed:

CLASS	TIME	DATE	LINE	DURATION	STATION	DIALLED No./CLI	ACCOUNT
POT	10:52	12/09	002	00:00:10	2001	2142623801	08754
PIN	10:52	12/09	001	00:00:20	2017	2142623802	NECinfrontia Corp.
PIN	10:53	12/09	002			2142623801	NO ANSWER

If Program 35-02-18 = 1 (Caller ID Name Output Method) is set to line feed, the SMDR displays as follows:

CLASS	TIME	DATE	LINE	DURATION	STATION	DIALLED No./CLI	ACCOUNT
POT	10:52	12/09	002	00:00:10	2001	2142623801	08754
PIN	10:52	12/09	001	00:00:20	2017	2142623802	NECinfrontia Corp.
NEXT NECinfrontia Corp.							
PIN	10:53	12/09	002			2142623801	NO ANSWER

### Sample SMDR Report (Internal)

Figure 2-85 Example of SMDR Report

CLASS	TIME	LINE	DURATION	STATION	DIALLED No./CLI	ACCOUNT
ICM	14:35		00:00:02	101	103	
ICM	14:36		00:00:18	101	102	
ICM	14:36		00:00:14	101	103	
ICM	14:37		00:00:10	101	103	
ICM	14:37		00:00:29	101	102	
ICM	14:41		00:00:15	101	102	
ICM	14:42		00:00:03	101	103	

03/27/2012 PAGE 001



**Flexible Transfer/Virtual Loopback Enhancement**

When calls are routed through the ISDN Virtual Loopback, the SMDR information does not provide enough information to provide complete tracking of route of the call. This has been enhanced with the addition of a tag to any part of the call that is routed through the virtual loopback to enable complete tracking of the call.

When a call is routed through the Virtual Loopback, or more precisely its S-point, it will return as a new incoming call on the Loopback T-point trunk port.

Figure 2-86 Virtual Loopback – S-Point

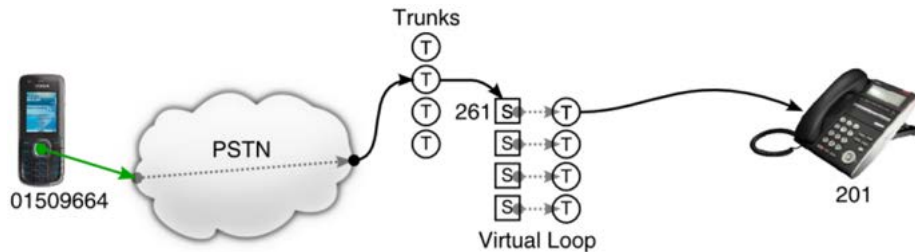

The SMDR will report this as follows:

Figure 2-87 Example of S-Point Report

01/07/2011 PAGE 004							
CLASS	TIME	LINE	DURATION	STATION	DIALLED No./CLI	RD/COST	ACCOUNT
17	IVIN	14:19 005	00:00:02	201	1509664	0:02	
18	IVIN	15:00 002	00:00:01	261	1509664	0:02	

To give the SMDR software an indication that the call is not terminated on the S-point and not a new call, but an extension of the first call, the PBX puts a special flag on the appropriate fields in the SMDR records.

Figure 2-88 Example of S-Point Report (Flagged)

01/07/2011 PAGE 004							
CLASS	TIME	LINE	DURATION	STATION	DIALLED No./CLI	RD/COST	ACCOUNT
17	IVIN	14:19 005V	00:00:02	201	1509664	0:02	
18	IVIN	15:00 002	00:00:01	005V	1509664	0:02	

The mark provides two functions. First, by using an encoding that is not a usual number or trunk port index, the SMDR software gets the information that a virtual loopback channel is used. Additionally, on the Virtual Loopback's S-points, the station's phone number isn't used, but the trunk port index of the associated T-point, again marked as virtual. This way, the SMDR software can directly use the mark as tag to link the calls together.

Figure 2-89 Virtual Loopback – T-Point

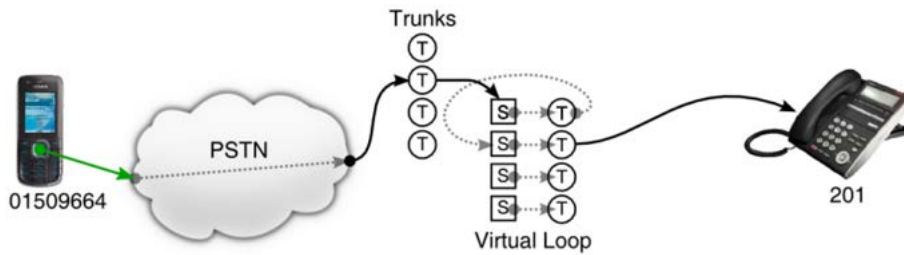

Tracking the call path is even then possible if the call is routed two or more times through the Virtual Loop:

The SMDR will then show like this:

Figure 2-90 Example of Twice Through Virtual Loop

							01/07/2011 PAGE 004
CLASS	TIME	LINE	DURATION	STATION	DIALLED No./CLI	RD/COST	ACCOUNT
17	IVIN 14:19	006V	00:00:02	201	1509664	0:21	
18	IVIN 15:00	005V	00:00:01	006V	1509664	0:21	
19	IVIN 15:00	002	00:00:01	005V	1509664	0:21	

Here, the call passes twice through the Virtual Loopback, the first time using trunk #5, the second time using trunk #6. Note the reverse order which is the result of the called party clearing the call, so that the last leg is printed first. The opposite order occurs if the calling party clears first:

Figure 2-91 Example of Twice Through Virtual Loop (Reverse Order)

							01/07/2011 PAGE 004
CLASS	TIME	LINE	DURATION	STATION	DIALLED No./CLI	RD/COST	ACCOUNT
17	IVIN 15:00	002	00:00:01	005V	1509664	0:21	
18	IVIN 15:00	005V	00:00:01	006V	1509664	0:21	
19	IVIN 14:19	006V	00:00:02	201	1509664	0:21	

This special tagging applies anytime Virtual Loop ports are used. If an extension uses a Virtual Loop T-point to dial 'out', this port is tagged in the SMDR report accordingly; as well the associated S-point.

The same applies if internal SMDR is enabled and the S-point is called. Then, the S-point is printed as tagged associated T-point. Here is an example of an external call being routed through the T-point of the Virtual Loop:

Figure 2-92 Virtual Loopback – External Call Routed Through T-Point

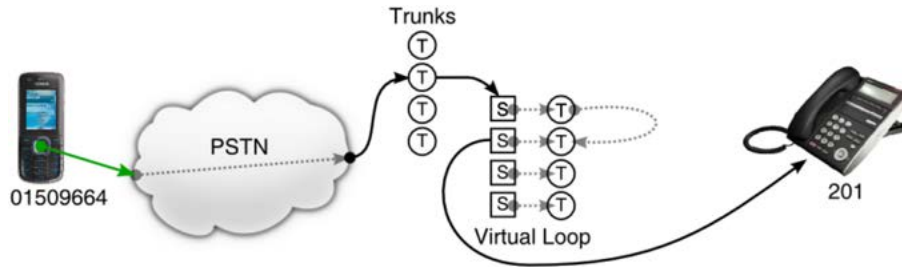

The SMDR output looks very similar to the one before, where the call was routed through the same T- and S-point ports, but in the other direction:

Figure 2-93 Example of Twice Through Virtual Loop (Reverse Direction)

							01/07/2011 PAGE 004
CLASS	TIME	LINE	DURATION	STATION	DIALLED No./CLI	RD/COST	ACCOUNT
17	IVIN	15:00 002	00:00:01	005V	1509664	0:21	
18	IVOT	14:19 006V	00:00:02	005V	1509664	0:21	
19	ICM	15:00 006V	00:00:01	201	1509664	0:21	

This intended purpose of the tagging is to link the first and last port of such a chain together. Note that the internal SMDR feature needs to be switched on in this case to get the call leg from S-point to extension printed.

Limitation

These programs must be set correctly to function:

Program 35-02-03= 1: Trunk Number

Program 35-02-09= 1: Extension Number



*This is not a real limitation however, if both are set to 0, matching names may be given to the T-point and S-point ports (e.g. “V-one”, “V-two”, ...) yielding the same functionality.*

Program 35-02-16 must be set to **1: Trunk Name/Number** otherwise, the received dialed number not the trunk port information is printed.

Table 2-109 SMDR Report Definitions

Report Heading	Definition
Call Record Number	SMDR record number (consecutive)
CLASS	Type of call (see Class Definitions below)
TIME	Time call placed or answered. (For Transferred calls, shows time user picked up Transfer.)
DATE	Date the call was made (Program 35-02-14=1). For Extension calls, this area is blank.
LINE	Trunk number used for call. For Extension calls, this area is blank.
DURATION	The time the call lasted. (For Transferred calls, shows how long user was on call after answering the Transfer.)
STATION	Extension number of call owner (i.e., extension that first placed or answered call) (For Transferred calls, there can be more than one owner – depending on how many extensions shared the call.)
DIALLED No./CLI	For outgoing calls, the number dialed or, for incoming calls, the Caller ID information
ACCOUNT	Account Code number entered by extension user. For Extension call, this area blank.
Class	Definition
POT	Outgoing trunk call
POTA	Outgoing trunk call placed using Toll Restriction Override
PIN	Incoming trunk calls
ALB	All lines in group are busy (group number follows TIME field)
BRD	Call blocked due to Toll Restriction
PTRS	Transferred call
IVIN	BRI/PRI inbound trunk call
ICM	Extension call

Table 2-110 SMDR Report Format with Program 35-02-14 Set to '0'

Character Position	Field Definition
<b>Header Line 1</b>	
1~60	Spaces
61~70	MM/DD/YYYY
71	Space
72~75	PAGE

Table 2-110 SMDR Report Format with Program 35-02-14 Set to '0' (Continued)

Character Position	Field Definition
76	Space
77~79	Report page number (e.g., 001)
CR & LF	Carriage return and line feed
<b>Header Line 2</b>	
1~5	CLASS
6	Space
7~10	TIME
11~14	Spaces
15~18	LIN
19~22	Spaces
23~30	DURATION
31~32	Spaces
33~39	STATION
40~44	Spaces
45~51	DIALLED
52	Space
53~59	No./CLI
60~63	Spaces
64~70	ACCOUNT
CR & LF	Carriage return and line feed
LF	Line feed
<b>SMDR Record</b>	
1~4	Call type (e.g., POT for outgoing)
5	Space
6~10	Time in 24 hour clock (HH:MM)
11	Space
12~21	LINE
22	Space
23~30	Call Duration (HH:MM:SS)
31	Space
32~41	Station number or name
42	Space

Table 2-110 SMDR Report Format with Program 35-02-14 Set to '0' (Continued)

Character Position	Field Definition
43~62	Number dialed (20 digits maximum)
63	Space
64~79	Account number or NO ANSWER

Table 2-111 SMDR Report Format with Program 35-02-14 Set to '1'

Character Position	Field Definition
<b>Header Line 1</b>	
1~60	Spaces
61~70	MM/DD/YYYY
71	Space
72~75	PAGE
76	Space
77~79	Report page number (e.g., 001)
CR & LF	Carriage return and line feed
<b>Header Line 2</b>	
1~5	CLASS
6	Space
7~10	TIME
11	Spaces
12~15	DATE
16~17	Spaces
18~21	LINE
22	Space
23~30	DURATION
31~32	Spaces
33~39	STATION
40~44	Spaces
45~51	DIALLED
52	Space
53~59	No./CLI
60~63	Spaces

Table 2-111 SMDR Report Format with Program 35-02-14 Set to '1' (Continued)

Character Position	Field Definition
64~70	ACCOUNT
CR & LF	Carriage return and line feed
LF	Line feed
<b>SMDR Record</b>	
1~4	Call type (e.g., POT for outgoing)
5	Space
6~10	Time in 24 hour clock (HH:MM)
11	Space
12~16	DATE
17	Space
18~21	LINE
22	Space
23~30	Call Duration (HH:MM:SS)
31	Space
32~41	Station number or name
42	Space
43~62	Number dialed (20 digits maximum)
63	Space
64~79	Account number or NO ANSWER

Table 2-112 SMDR Summary Report

<b>OUTGOING CALL/COST SUMMARY</b>
<b>FOR DAY OF nn/nn/nn</b>
TOTAL NO. OF OUTGOING PSTN CALLS: 0
TOTAL NO. OF OUTGOING ISDN CALLS: 0
NO. OF OUTGOING PSTN CALLS COSTED: 0 COST: 0
NO. OF OUTGOING ISDN CALLS COSTED: 0 COST: 0
<b>OUTGOING CALL/COST SUMMARY</b>
<b>SUMMARY FOR WEEK ENDING nn/nn/nn</b>
TOTAL NO. OF OUTGOING PSTN CALLS: 49
TOTAL NO. OF OUTGOING ISDN CALLS: 0
NO. OF OUTGOING PSTN CALLS COSTED: 0 COST: 0
NO. OF OUTGOING ISDN CALLS COSTED: 0 COST: 0
<b>OUTGOING CALL/COST SUMMARY</b>
<b>FOR MONTH ENDING nn/nn/nn</b>
TOTAL NO. OF OUTGOING PSTN CALLS: 49
TOTAL NO. OF OUTGOING ISDN CALLS: 0
NO. OF OUTGOING PSTN CALLS COSTED: 0 COST: 0
NO. OF OUTGOING ISDN CALLS COSTED: 0 COST: 0

### Conditions

- SMDR can record/print both system trunk and internal calls. The buffer stores calls when the SMDR device is unavailable. When the buffer fills, SMDR will not collect any new calls until the buffer is cleared.
- The SV9100 can buffer up to 4000 calls.
- When SMDR reports are enabled using the same port as the Traffic Reporting feature (example: 147), the SMDR blocks the Traffic reports. Unplug the cable and plug it back in to allow Traffic reports to print.
- SMDR requires a connection to the GCD-CP10 LAN.
- DT300 and DT700 style terminals do not support a RS232 serial connection for SMDR output.



- If no answer is received, NO ANSWER is displayed regardless of the system programming for the Caller ID display option (Trunk only).
- The setting in Program 35-02-18 works regardless of the entry in Program 35-02-15 or 35-02-17.
- When Program 35-02-18 is set to 1, the first and second lines are sometimes separated. When the buffer is full, the overflowed data may not be shown.
- The special characters used in the UNIVERGE SV9100 system cannot be output to the SMDR – they are converted to (\_).
- To use the PBX Call Reporting option, program system for behind PBX operation.
- Calls made from Virtual Extensions show up in SMDR as calls made from the physical extension the VE resides on.
- Terminals that have a tandem setting is not supported in Internal SMDR feature.
- Internal SMDR is not included in the Summary Report (Programs 35-02-04, 35-02-05 or 35-02-06).
- Internal calls to or from a door phone are not included in the SMDR output.
- When using internal SMDR, blind transfers generate two records and the duration is recorded as between those two stations.
- When using internal SMDR, screened transfers generate three records, and the duration overlaps between those three extensions.
- CCIS Centralized Billing will only buffer 320 calls.
- The SMDR call records will be buffered when the system cannot output the SMDR information due to the lost connection.
- When the connection is active, the SMDR information will be immediately output and it will not be buffered.
- When the system is powered off, all current records in the buffer are deleted.
- When the buffer fills, the oldest record remains and the new record is counted as overflow records.
- When using the free license and it expires, only the first 320 calls are buffered or output.
- SMDR supports the option to tag Virtual Loopback calls.
- A maximum of 10 devices can simultaneously collect SMDR.
- Only one SMDR buffer exists in the SV9100 even if multiple SMDR collection devices are being used.
- SMDR does not buffer for devices that are disconnected. For example, if two SMDR collection devices are installed and collecting SMDR output and one device is disconnected, SMDR continues sending output to the remaining connected device.

### Default Settings

Disabled

## System Availability

### Terminals

- All Terminals (with Trunk SMDR)
- All Terminals except Virtual extension (with Internal SMDR)

### Required Component(s)

None

## Related Features

- ➔ **PBX Compatibility**
- ➔ **Traffic Reports**

## Guide to Feature Programming

The **Level 1**, **Level 2** and **Level 3** columns indicate the programs that are assigned when programming this feature in the order they are most commonly used. These levels are used with PCPro and WebPro wizards for feature programming.

- Level 1 – these are the most commonly assigned programs for this feature.
- Level 2 – these are the next most commonly assigned programs for this feature.
- Level 3 – these programs are not often assigned and require an expert level working knowledge of the system to be properly assigned.

Program Number	Program Name/Description	Input Data	Default	Level		
				1	2	3
10-12-01	<b>GCD-CP10 Network Setup – IP Address</b> Assign the IP Address.	0.0.0.0 ~ 126.255.255.254 128.0.0.1 ~ 191.255.255.254 192.0.0.1 ~ 223.255.255.254	192.168.0.10	✓		

Program Number	Program Name/Description	Input Data	Default	Level		
				1	2	3
10-20-01	<p><b>LAN Setup for External Equipment – TCP Port</b></p> <p>Define the TCP port (0 ~ 65535) when communicating to the SMDR (type 5).</p>	0 ~ 65535	External Device 1 (CTI Server) = 0 External Device 2 (MIS) = 4000 External Device 5 (SMDR Output) = 0 External Device 6 (DIM Output) = 0 External Device 11 (O&M Server) = 8010 External Device 12 (Traffic Report Output) = 0 External Device 13 (Room Data Output for Hotel Service) = 0 External Device 14 (IP-DECT Directory Access) = 0	✓		
10-20-03	<p><b>LAN Setup for External Equipment – Keep Alive Time</b></p> <p>Define the keep alive time for communicating to external equipment.</p>	1 ~ 255 seconds	30	✓		
14-01-06	<p><b>Basic Trunk Data Setup – SMDR Printout</b></p> <p>Have the system print or Not print the trunk you are programming in the SMDR printout. Refer to Programs 35-01 and 35-02 for SMDR printout options.</p>	0 = No Print Out 1 = Prints Out	0	✓		
14-04-01	<p><b>Behind PBX Setup</b></p> <p>For ANI/DNIS, the following additional setting is recommended: Behind PBX = 0 (Stand Alone).</p>	0 = Stand Alone (Trunk) 1 = Behind PBX (PBX) 2 = Not Used 3 = CTX assume 9	0		✓	
15-01-03	<p><b>Basic Extension Data Setup – SMDR Printout</b></p> <p>For each extension, enter 1 if extension calls should print on the SMDR report. Enter 0 if extension calls should not print on the SMDR report.</p>	0 = Do not print on SMDR report 1 = Include on SMDR report	1	✓		
15-01-14	<p><b>Basic Extension Data Setup – SMDR Output of Maid Intercom Calls</b></p> <p>When set to 0 (Disable) it will not record sent internal calls.</p>	0 = Disable 1 = Enable	0	✓		

Program Number	Program Name/Description	Input Data	Default	Level		
				1	2	3
15-01-15	<b>Basic Extension Data Setup – SMDR Output of Answered Intercom Calls</b> When set to 0 (Disable) it will not record received internal calls.	0 = Disable 1 = Enable	0	✓		
16-02-01	<b>Department Group Assignment for Extensions – Extension Group Setting</b> Use to set up the extension group.	1 ~ 64	1		✓	
20-07-18	<b>Class of Service Options (Administrator Level) – SMDR Printout Accumulated Extension Data</b> Determine if Accumulated Extension Data is included in the SMDR report for each COS.	0 = Off 1 = On	COS 1 ~ 14 = 0 COS 15 = 1		✓	
20-07-19	<b>Class of Service Options (Administrator Level) – SMDR Printout Department Group (STG) Data</b> Determine if Department Group (STG) Data is included in the SMDR report for each COS.	0 = Off 1 = On	COS 1 ~ 14 = 0 COS 15 = 1		✓	
20-07-20	<b>Class of Service Options (Administrator Level) – SMDR Printout Accumulated Account Code Data</b> Determine if Accumulated Account Code Data is included in the SMDR report for each COS.	0 = Off 1 = On	COS 1 ~ 14 = 0 COS 15 = 1		✓	
20-13-36	<b>Class of Service Options (Supplementary Service) – Call Duration Timer Display</b> Turn Off or On a Call Timer for the extension.	0 = Off 1 = On	COS 1 ~ 15 = 1		✓	
35-01-01	<b>SMDR Options – Output Port Type</b> Specify the type of connection used for SMDR. The baud rate for the COM port should be set in Program 15-02-19.	0 = No setting 1 = Not used 2 = Not used 3 = LAN (CCPU) 4 = Not used	0	✓		
35-01-03	<b>SMDR Options – Header Language</b> Specify the language in which the SMDR header should be printed.	0 = English 1 = German 2 = French 3 = Italian 4 = Spanish	0		✓	
35-01-04	<b>SMDR Options – Omit Digits</b> The number of digits entered in this option do not print on the SMDR report. Enter 0 if you want to print all digits.	0 ~ 24 (0 = None omitted)	0		✓	
35-01-05	<b>SMDR Options – Minimum Digits</b> Outgoing calls must have at least this number of digits for inclusion in the SMDR report. Enter 0 to include all outgoing calls, regardless of the number of digits dialed.	0 ~ 24 (0 = Include all)	0	✓		

Program Number	Program Name/Description	Input Data	Default	Level		
				1	2	3
35-01-06	<b>SMDR Options – Minimum Call Duration</b> The duration of a call must be at least this time to be included on the SMDR report. Enter 0 to have calls of any duration print.	0 ~ 65535 seconds (0 = All)	0	✓		
35-01-07	<b>SMDR Options – Minimum Ring Time (For Incoming Calls)</b> A call must ring for at least this time to be included on the SMDR report. Enter 0 to allow all calls to print.	0 ~ 65535 seconds (0 = All)	0		✓	
35-01-08	<b>SMDR Options – Format Selection</b> <i>Do not change:</i> This option is added to allow an increased account code field from eight to 16 when used in the U.K. This allows 16 characters of the Caller ID name to be displayed. For the U.S., this option is set to 0 and should remain at this setting as 16 characters are already provided for the account code field.	0 = NA Type (North America) 1 = G/J Type (Overseas/ Japan)	0			✓
35-02-01	<b>SMDR Output Options – Toll Restricted Call</b> SMDR can include or exclude calls blocked by Toll Restriction.	0 = Not Displayed 1 = Displayed	1		✓	
35-02-02	<b>SMDR Output Options – PBX Calls</b> When the system is behind a PBX, SMDR can include all calls (1) or just calls dialed using the PBX trunk access code (0).	0 = Not Displayed 1 = Displayed	1		✓	
35-02-03	<b>SMDR Output Options – Trunk Number or Name</b> Select whether the system should display the trunk name or number on SMDR reports.  ➡ If this option is set to 0, Program 35-02-14 must be set to 0.	0 = Name 1 = Number	1		✓	
35-02-04	<b>SMDR Output Options – Summary (Daily)</b> Set this option to 1 to have the SMDR report provide a daily summary (at midnight every night).	0 = Not Displayed 1 = Displayed	1		✓	
35-02-05	<b>SMDR Output Options – Summary (Weekly)</b> Set this option to 1 to have the SMDR report provide a weekly summary (every Saturday at midnight).	0 = Not Displayed 1 = Displayed	1		✓	
35-02-06	<b>SMDR Output Options – Summary (Monthly)</b> Set this option to 1 to have the SMDR report provide a monthly summary (at midnight on the last day of the month).	0 = Not Displayed 1 = Displayed	1		✓	
35-02-07	<b>SMDR Output Options – Toll Charge Cost</b> Set this option to 1 have the SMDR report include toll charges.	0 = Not Displayed 1 = Displayed	1		✓	

Program Number	Program Name/Description	Input Data	Default	Level		
				1	2	3
35-02-08	<b>SMDR Output Options – Incoming Call</b> Enable this option (1) to have the SMDR report include incoming calls. If you disable this option (0), incoming calls do not print.	0 = Not Displayed 1 = Displayed	1		✓	
35-02-09	<b>SMDR Output Options – Extension Number or Name</b> Set this option to 1 to have the SMDR report include extension numbers. Set this option to 0 to have the SMDR report include extension names.	0 = Name 1 = Number	1		✓	
35-02-10	<b>SMDR Output Options – All Lines Busy (ALB) Output</b> Determine if the All Lines Busy (ALB) indication should be displayed.	0 = Not Displayed 1 = Displayed	0		✓	
35-02-11	<b>SMDR Output Options – Walking Toll Restriction Table Number</b> Set the SMDR (Station Message Detail Recording) walking toll restriction table number output options.	0 = Not Output 1 = Output	1		✓	
35-02-12	<b>SMDR Output Options – DID Table Name Output</b> Determine if the DID table name should be displayed for incoming DID calls.	0 = Not Displayed 1 = Displayed	0		✓	
35-02-13	<b>SMDR Output Options – CLI Output When DID to Trunk</b> Determine if the Caller ID should be displayed when the incoming DID number is transferred to an outgoing trunk.	0 = Not Displayed 1 = Displayed	0		✓	
35-02-14	<b>SMDR Output Options – Date</b> Determine whether or not the date should be displayed on SMDR reports. ➤ <i>This option must be set to 0 if the trunk name is set to be displayed in Program 35-02-03.</i>	0 = Not Displayed 1 = Displayed	0		✓	
35-02-15	<b>SMDR Output Options – CLI/DID Number Switching</b> Determine whether the CLI or DID Calling Number should be displayed.	0 = CLI (CLIP) 1 = DID Calling Number 2 = Caller ID Name	0		✓	
35-02-16	<b>SMDR Output Options – Trunk Name or Received Dialed Number</b> Determine how the SMDR should print incoming calls on ANI/DNIS or DID trunks. If set to 1, ANI/DNIS trunks can print DNIS digits. If set to 0 trunk names are printed instead (assigned in Program 14-01-01). ➤ <i>With Version 5000 or higher, Option 2 is available.</i>	0 = Trunk Port Name 1 = Received Dialed Number 2 = Both	0		✓	

Program Number	Program Name/Description	Input Data	Default	Level		
				1	2	3
35-02-17	<p><b>SMDR Output Options – Print Account Code or Caller Name of Incoming Call</b></p> <p>Determine whether the Account Code or Caller ID name should print in the SMDR record.</p> <p>➔ Program 35-01-08 must be set to 0 for this entry to be followed.</p>	<p>0 = ACC</p> <p>1 = CNAME</p>	0		✓	
35-02-18	<p><b>SMDR Output Options – Print Mode for Caller Name of Incoming Call</b></p> <p>Determine how SMDR should print Caller Name of incoming call. Select whether to display up to 16 characters of the Caller Name on the same line as the call record (0) or if a line feed should be added and up to 24 characters of the Caller Name are displayed on the following line (1). If the line feed option is selected, the Caller Name is displayed on the next line as : NEXT Caller Name.</p> <p>This setting works regardless of the setting in Program 35-02-15.</p> <p>➔ With this option set to 1, if your communications program (such as HyperTerminal) has the line wrap option enabled in the ASCII setup, an additional line break may appear above the Caller name line.</p>	<p>0 = Normal</p> <p>1 = Line Feed</p>	0		✓	
35-02-21	<p><b>SMDR Output Options – S-Point Terminal Number</b></p> <p>Set up SMDR Port.</p>	<p>0 = MSN Number</p> <p>1 = Extension Number</p>	0			✓
35-02-22	<p><b>SMDR Output Options – Security Auto Dialing</b></p> <p>Select whether the system should display the SAD (Security Auto Dialing) on SMDR report.</p>	<p>0 = No Output</p> <p>1 = Output</p>	0		✓	
35-02-23	<p><b>SMDR Output Options – Watch Auto Dialing</b></p> <p>Select whether the system should display the WAD (Warning Auto Dialing) on SMDR report.</p>	<p>0 = No Output</p> <p>1 = Output</p>	0			✓
35-02-24	<p><b>SMDR Output Options – Mark Virtual Loop</b></p> <p>Define whether calls routed via the ISDN Virtual Loopback are tagged.</p>	<p>0 = Don't Mark</p> <p>1 = Mark</p>	0		✓	
80-05-01	<p><b>Date Format for SMDR and System – Date Format</b></p> <p>Set the date format for SMDR.</p>	<p>0 = American Format (Month / Day / Year)</p> <p>1 = Japanese Format (Year / Month / Day)</p> <p>2 = European Format (Day / Month / Year)</p>	0		✓	

SMDR flowcharts are located on the following pages.

### SMDR with a GCD-CP10 Connection - Ethernet

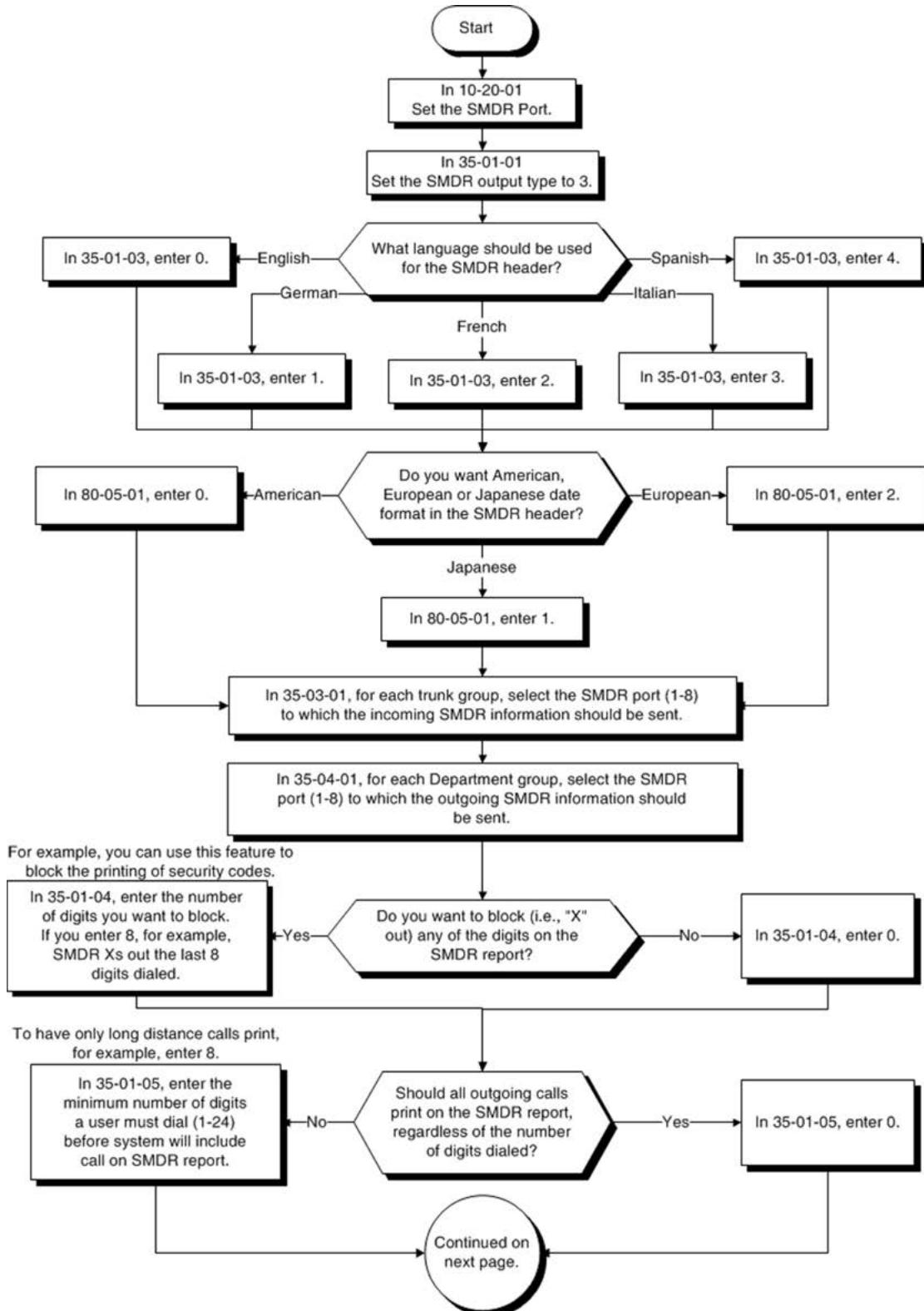



**SMDR Flowchart (Continued)**

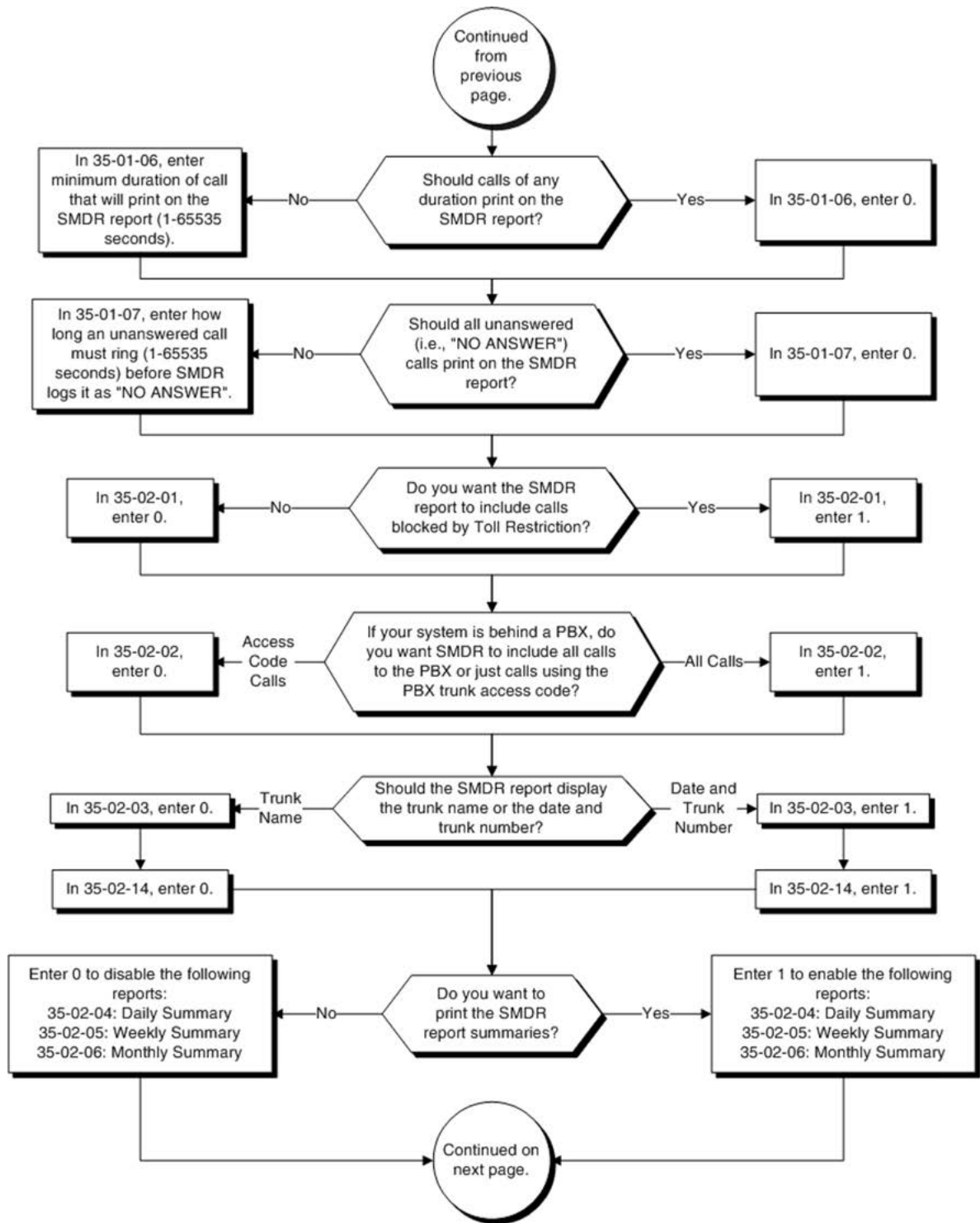

### SMDR Flowchart (Continued)

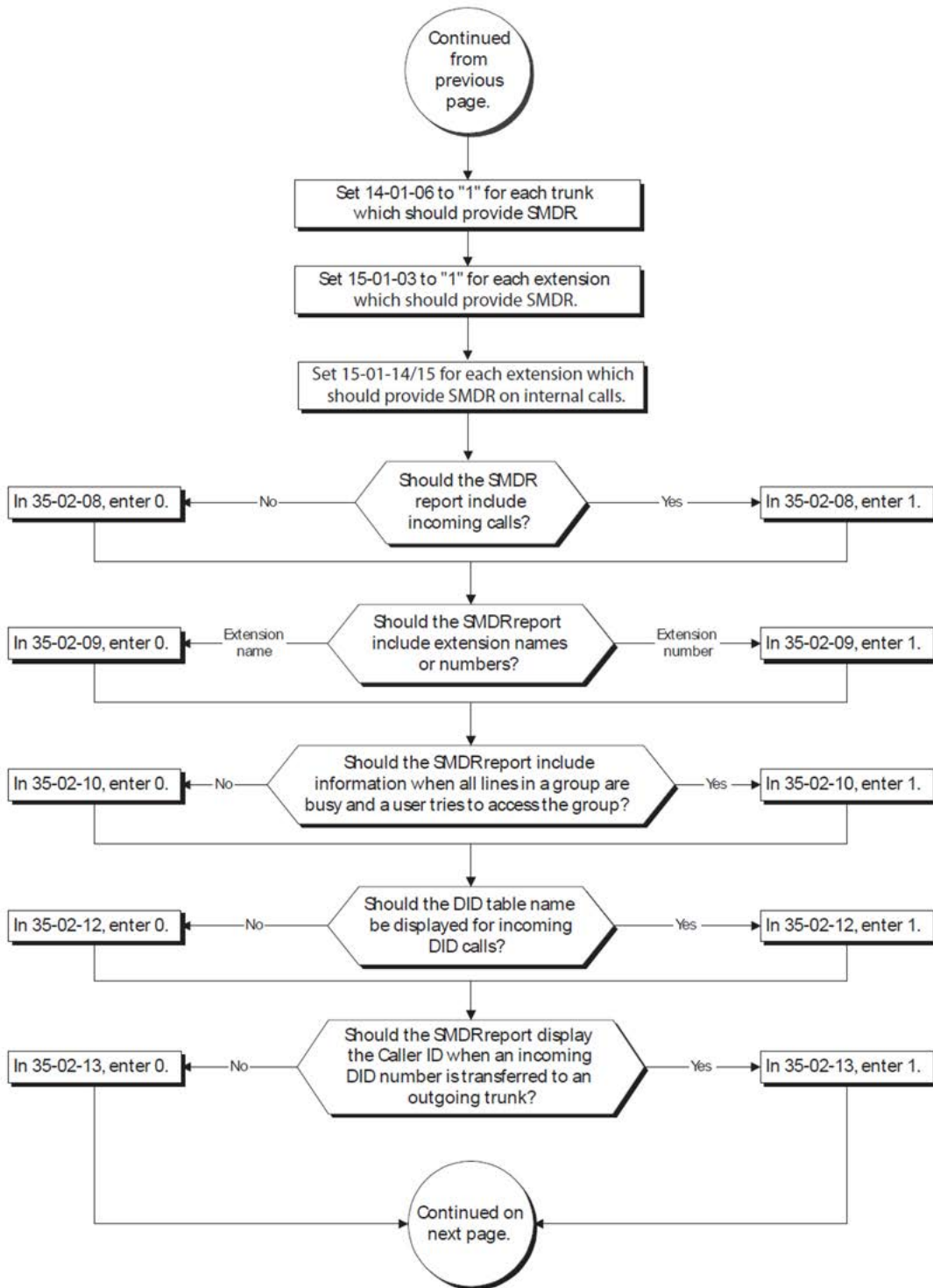

**SMDR Flowchart (Continued)**

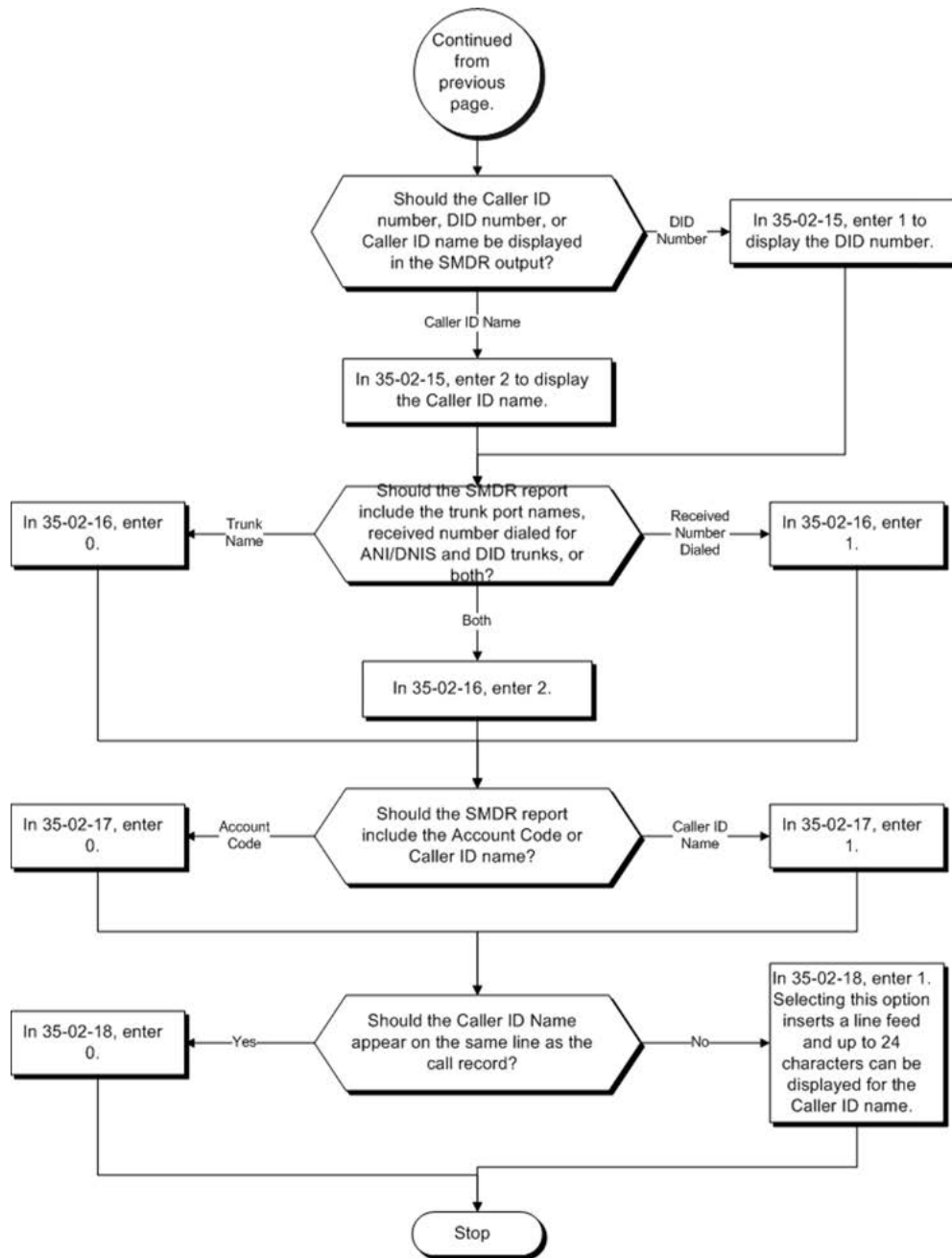

**Operation**

Once installed and programmed, SMDR operation is automatic.

## Station Name Assignment – User Programmable

### Description

This feature allows a user to program the Station Name for their telephone extension or any extension in the system. The name is displayed on the multiline terminal LCD when an intercom or K-CCIS call is placed.

#### Conditions

- Display telephones use extension names for Directory Dialing.
- Single line telephone extensions cannot program names.

#### Default Settings

Enabled

### System Availability

#### Terminals

All Multiline Terminals with Display

#### Required Component

None

### Related Features

- ➔ **Directory Dialing**
- ➔ **Name Storing**

## Guide to Feature Programming

The **Level 1**, **Level 2** and **Level 3** columns indicate the programs that are assigned when programming this feature in the order they are most commonly used. These levels are used with PCPro and WebPro wizards for feature programming.

- Level 1 – these are the most commonly assigned programs for this feature.
- Level 2 – these are the next most commonly assigned programs for this feature.
- Level 3 – these programs are not often assigned and require an expert level working knowledge of the system to be properly assigned.

Program Number	Program Name/Description	Input Data	Default	Level		
				1	2	3
11-11-22	<b>Service Code Setup (for Setup/Entry Operation) – Extension Name Programming</b> Customize the extension name programming used for registration and setup.	MLT 0 ~ 9, *, # Maximum of eight digits	700		✓	
15-01-01	<b>Basic Extension Data Setup – Extension Name</b> Define the extension/virtual extension name.	Maximum of 12 characters.	STA 101 = Ext 101 STA 102 = Ext 102, etc.	✓		
15-07-01	<b>Programmable Function Keys</b> Assign an Extension Name Change key (55) to extensions.	Line Key 1 ~ 48 0 ~ 99 (Normal Function Code 751 by default) *00 ~ *99 (Appearance Function Code) (Service Code 752 by default)	Refer to the Programming Manual for default values.		✓	
20-06-01	<b>Class of Service for Extensions</b> Assign a Class of Service (1 ~ 15) to an extension.	Day Night/Mode: 1 ~ 8 Class of Service of Extensions (1 ~ 15)	Extension port 101 = Class 15 All other extension port = Class 1		✓	
20-13-21	<b>Class of Service Options (Supplementary Service) – Extension Name</b> Turn Off or On an extension user ability to program its name.	0 = Off 1 = On	COS 1 ~ 15 = 1		✓	

## Operation

### To program your extension name:

1. Press **Speaker**.
2. Dial **700**.  
- OR -  
Press the **Extension Name Change** key (Program 15-07 or SC 751: 55).
3. Press **Hold**.
4. Enter the name. (Refer to [Table 2-113 Keys for Entering Names.](#))  
◇ *Your name can be up to 12 digits maximum.*
5. Press **Hold**.
6. Press **Speaker** to hang up.

### To program any extension name:

1. Press **Speaker**.
2. Dial **700**.  
- OR -  
Press the **Extension Name Change** key (Program 15-07 or SC 751: 55).
3. Enter the extension number to be named.
4. Enter a name. (Refer to [Table 2-113 Keys for Entering Names.](#))  
◇ *The name can be have to 12 digits maximum.*
5. Press **Hold**.
6. Press **Speaker** to hang up.

Table 2-113 Keys for Entering Names

Use this keypad digit . . .	When you want to . . .
1	Enter characters: 1 @ [ ¥ ] ^ _ ` {   } Æ " Á À Â Ã Ç É Ê ì ó
2	Enter characters: <b>A-C, a-c, 2.</b>
3	Enter characters: <b>D-F, d-f, 3.</b>
4	Enter characters: <b>G-I, g-i, 4.</b>
5	Enter characters: <b>J-L, j-l, 5.</b>
6	Enter characters: <b>M-O, m-o, 6.</b>
7	Enter characters: <b>P-S, p-s, 7.</b>

Table 2-113 Keys for Entering Names (Continued)

Use this keypad digit . . .	When you want to . . .
<b>8</b>	Enter characters: <b>T-V, t-v, 8.</b>
<b>9</b>	Enter characters: <b>W-Z, w-z, 9.</b>
<b>0</b>	Enter characters: 0 ! “ # \$ % & ’ ( ) ô Õ ú ä ö ü α ε θ
<b>*</b>	Enter characters: * + , - . / : ; < = > ? π Σ σ Ω ∞ € £
<b>#</b>	<b>#</b> = Accepts an entry (only required if two letters on the same key are needed - ex: TOM). Pressing <b>#</b> again = Space. (In system programming mode, use the right arrow Softkey instead to accept and/or add a space.)
<b>Feature</b>	Clear the character entry one character at a time (when using service code or function key).
<b>Recall</b>	Clear the character entry one character at a time (when in telpro).
<b>Hold (Telpro Mode Only)</b>	Clear all the entries from the point of the flashing cursor and to the right.

## Station Relocation

### Description

Station Relocation allows a station to be moved (swapped) from one location to another, without having to reprogram the station data. The station features and extension number are the same after it is moved to the new location.



NOTE

*Refer to the Programming section in this feature for system programs that are swapped.*

### Conditions

- This feature can be used to swap or relocate multiline and single line terminals.
- This feature is not supported for IP terminals (Softphone or a physical IP phone).
- The destination extension must be idle. If the station is not idle, error tone is heard.
- If the Extension Swap service code is dialed from an extension that does not have an extension swap password programmed, error tone is heard.
- If the Extension Swap service code is dialed from an extension whose Class of Service does not allow Extension Data Swap, error tone is heard.
- If the destination extension entered is not a valid extension, error tone is heard.
- The following user setting data is relocated with the extension. All other user setting data is either not relocated or cleared.
  - DND
  - Call Forwarding
  - Memo Dial
  - Last Number Dial History
  - Saved Number Dial
  - Incoming History
  - MIC LED Status
  - VM MW LED Status
- When using Set Relocation, and a terminal is re-located from one physical system to another physical system, route programming must be made accordingly for 911 calls.

### Default Settings

None



## System Availability

### Terminals

All Multiline Terminals and Single Line Telephones

### Required Component(s)

None

## Related Features

None

## Guide to Feature Programming

The **Level 1**, **Level 2** and **Level 3** columns indicate the programs that are assigned when programming this feature in the order they are most commonly used. These levels are used with PCPro and WebPro wizards for feature programming.

- Level 1 – these are the most commonly assigned programs for this feature.
- Level 2 – these are the next most commonly assigned programs for this feature.
- Level 3 – these programs are not often assigned and require an expert level working knowledge of the system to be properly assigned.

Program Number	Program Name/Description	Input Data	Default	Level		
				1	2	3
11-15-12	<b>Service Code Setup, Administrative (for Special Access – Extension Data Swap</b> Ext. Data Swap = xxx (service code in accordance with Program 11-01).	MLT, SLT 0 ~ 9, *, # Maximum of eight digits	No Setting	✓		
20-13-42	<b>Class of Service Options (Supplementary Service) – Extension Data Swap Enabling</b> Turn Off or On an extension user ability to use Station Relocation.	0 = Off 1 = On	COS 1 ~ 15 = 1		✓	
92-05-01	<b>Extension Data Swap Password – Password</b> Fixed 4-Digits.	Fixed four digits (No setting at default)	No Setting	✓		

**The following programs are swapped when Station Relocation is used:**

- Program 11-02 Extension Numbering
- Program 12-05 Night Mode Group Assignment for Extensions
- Program 13-03 Speed Dialing Group Assignment for Extensions
- Program 15-01 Basic Extension Data Setup
- Program 15-02 Multiline Telephone Basic Data Setup
- Program 15-03 Single Line Telephone Basic Data Setup
- Program 15-06 Trunk Access Map for Extensions
- Program 15-07 Programmable Function Keys
- Program 15-08 Incoming Virtual Extension Ring Tone Setup
- Program 15-09 Virtual Extension Ring Assignment
- Program 15-10 Incoming Virtual Extension Ring Tone Order Setup
- Program 15-11 Virtual Extension Delayed Ring Assignment
- Program 15-12 Conversation Recording Destination for Extensions
- Program 15-14 Programmable One-Touch Keys
- Program 15-20 LCD Line Key Name Assignment
- Program 16-02 Department Group Assignment for Extensions
- Program 20-06 Class of Service for Extensions
- Program 21-02 Trunk Group Routing for Extensions
- Program 21-04 Toll Restriction Class for Extensions
- Program 21-07 Toll Restriction Override Password Setup
- Program 21-10 Dial Block Restriction Class Per Extension
- Program 21-11 Extension Ringdown (Hotline) Assignment
- Program 21-13 ISDN Calling Party Number Setup for Extensions
- Program 21-15 Individual Trunk Group Routing for Extensions
- Program 21-19 IP Trunk (SIP) Calling Party Number Setup for Extension
- Program 23-02 Call Pickup Groups
- Program 23-03 Universal Answer/Auto Answer
- Program 23-04 Ringing Line Preference for Virtual Extensions
- Program 24-03 Park Group
- Program 26-04 ARS Class of Service
- Program 30-02 DSS Console Extension Assignment

- Program 31-02 Internal Paging Group Assignment
- Program 41-02 Group and Agent Assignments
- Program 41-17 Login Mode Setup
- Program 42-02 Hotel/Motel Telephone Setup

## Operation

### To exchange two terminals:

1. Pick up the handset or press **Speaker**.
2. Dial the Extension Data Swap Service Code – not assigned at default (Program 11-15-12).
3. Dial the Extension Data Swap Password – not assigned at default (Program 92-05-01).
4. Dial the extension to be swapped with or relocated to.
5. When successfully completed, confirmation tone is heard and the display shows completed.
6. Press **Speaker** twice to exit.

## SV9100 InGuard

### Description

The SV9100 InGuard (Toll Fraud Guard), is an active call monitoring application used to help prevent toll fraud. It works by monitoring SMDR output provided by the PBX and applies user-configured rules to look for call trends that may be fraudulent. When potential fraudulent activity takes place, the guard sends an email notification to users to inform them of the suspicion. As the application runs on the PBX, it has the ability to prevent further fraudulent activity from taking place by modifying its configuration.

There are two stages to the blocking actions for outbound calls; the alerts are first set to warn the user about the possible fraudulent activity. Secondly, an automatic blocking action is implemented to either place the extension in a restrictive toll restriction class or prevent the number from dialing out.

### Rules

Once the guard is configured, different rules can be applied to trigger notifications. By default, rules are system-wide for all telephone numbers, all trunks, and all extensions. They are also created against a time range, allowing different thresholds to trigger rules based on the time of day and day of the week.

- ❑ **Blocking Actions** – When configured, these rules have the ability to either restrict an extension from dialing out or block a number from being dialed.
  - **Target Number Rate** – Target Number Rate rules look for repeated outbound calls from any extension to the same number, this is a common symptom of Toll Fraud. The guard looks only at the first eight digits that are dialed, not the complete number. This allows the Guard to capture dialing patterns for similar numbers.

When the Block action is triggered, the number is automatically blocked by adding it to the Restrict Table in the PBX and an Email is sent to the user. The user may reply to the Email to unblock the number.
  - **Extension Call Rate** – A higher than expected call rate is another common symptom of Toll Fraud. If an extension on a PBX had been compromised, a hacker could make many calls over a period of time. The extension call rate rules allow you to enter the expected call rate for an extension and if that rate is exceeded an alert can be triggered.

When the Block action is triggered, the extension is automatically moved to the configured Toll Restriction Class. The user may reply to the Email to undo the action, they will be moved back to their original Toll Restriction Class.
- ❑ **Other Actions** – This allows certain calls to be ignored by the Guard.
  - **Stop Checking** – Stop Checking is a rule that can be defined to prevent the Guard from looking at certain call types.



REFERENCE

*Refer to the UNIVERGE SV9100 InGuard User Guide for rule creation.*

## Email Configuration

The Guard uses Emails to inform users when Toll Fraud rules have been broken. The Guard sends Emails using SMTP. Typically, the administrator of the mail server assigns an Email address that the Guard uses. The Guard should work with any SMTP mail server and has been specifically tested with MailServer and Gmail.

If the mail server is entered as a hostname, DNS must be entered in Program command 10-12-13.

### Conditions

- The InGuard application only works with outbound calls. This is not applicable on incoming and intercom calls.
- The application makes use of XML Pro. The XML Pro license is built-in with the application. Only license 3512 is required.
- Email configuration should be done correctly for InGuard to work effectively.
- If the **Target Number rate** rule is triggered, application will only display **Dialed Number/ Target Number** in the warning/block mail.
  - ◇ *Emergency call destination must be set considering this feature's purpose.*
  - ◇ *If the rule is triggered for a given prefix number, only the prefix number will be updated in the Restrict Code Table, not the complete dialed number.*
  - ◇ *If the rule is triggered for **No prefix**, the complete dialed number (maximum of eight digits) will be updated in the Restrict Code Table.*
- If the **Extension Call rate** rule is triggered, application will only display the **Extension Number** that made the excessive call in the warning/block mail.
  - ◇ *Application does not display the dialed number when using the Extension call Rate.*
- If blocking action is attempted and the restrict table is full, the new entry will be updated at the last position in the Restrict Code Table (FIFO process).
  - ◇ *After new entry is updated on 60th position, old entries will be shifted from their **last position - 1**. First position entry will be deleted.*
- Rules can be triggered for numbers allowed in the permit code table, but restrictions will not be applied to these numbers.
- In the InGuard application, do not delete the **phone/lines** tag, if the **phone/lines** tag is being used by any rule.

### Default Settings

None

## System Availability

### Terminals

All Terminals

### Required Components

- 0415 – SV9100 Version Lic (R5)
- 3512 – SV9100 Toll Fraud Guard

## Related Features

- ➔ **Code Restriction**
- ➔ **Station Message Detail Recording**

## Guide to Feature Programming



— *Refer to the UNIVERGE SV9100 InGuard Installation Manual for PBX and application programming.*

## Operation

None

## SV9100 NetLink

### Description

The NetLink feature allows up to 50 sites to be linked together over a Data Communication IP NetLink that allows Remote Sites to have the same service features as the Main Site, acting as one system. Systems can be installed separately in the same building or in remote offices connected via a qualified IP network.

With NetLink, the maximum system capacity still applies (400 Trunks and 896 Stations), but the ports can be distributed between sites using an SV9100 CHS2UG-US chassis at each location.

Each site must have a GPZ-IPLD daughter board and SD-B1 (4GB) card installed on its GCD-CP10 blade. The GCD-CP10 blade at each Remote Site must have the same data as the Main Site GCD-CP10 blade. The Main Site automatically uploads the system data to the Remote Sites anytime it changes.

The Main Site requires a proper SV9100 NETLINK NODE License for each Remote Site.

When a communication failure occurs between the Main Site and any Remote Site, the Main Site GCD-CP10 blade automatically changes to survival mode and operates as a stand-alone system. If multiple Remote Sites are installed, a Remote Site can be assigned as a temporary Main Site to control remaining connected sites.

If connecting a Remote site with SV8100 hardware, the hardware must first be removed to let Netlink establish a connection. The reason for this is the Remote site must first pull the Licensing for Hardware Migration from the Primary site. Once Netlink has established you can slot the SV8100 hardware. The connection status can be verified by logging in the Primary system and checking Blade configuration.

### MTU Size

In some network environments, the MTU size of the CCPU or IPL NIC may need to be changed. With **Version 2000 or lower** the MTU size was fixed to 1500 for both the CCPU and IPL NIC. With **Version 3000 or higher** the MTU size can now be changed for both the CCPU and IPL NIC.

If data to be sent is greater than defined in MTU, the data is transmitted in two or more packets as defined in the MTU.

### Conditions

- MTU size defined in Program 10-12-18 is applied on the packets transmitted from the IP address defined in Program 10-12-01.
- MTU size defined in Program 10-12-19 is applied on the packets transmitted from the IPL IP address defined in Program 10-12-09.
- The MTU size value is applied after logging out from WebPro, PcPro or TelPro.
- MTU is not applied on RTP/RTCP packets generated from DSP of VoIPDB.

- Systems using NetLink no longer refer to programs 10-46-06 SIP Registrar Port and 10-46-13 Subscribe Session Port. New programs 51-17-01 and 51-17-02 are used to change the ports on a per system basis when connecting IP phones via NAPT.
- The Primary System (Main Site) requires the appropriate NetLink licenses dependent upon the number of nodes in the NetLink network.
- Up to 50 Nodes can be supported in a NetLink network.
- A maximum of 240 Virtual slots are supported.
- Port assignment is performed sequentially by the requested order from the Secondary Systems.
- All nodes in a NetLink network should have the same main GCD-CP10 software.
- When a Terminal is placed on hold, the Music on Hold comes from the system where the Terminal resides.
- When a trunk is placed on hold, the Music on Hold comes from the system where the trunk resides.
- External Paging uses an output on the GCD-CP10 of the Primary System.
- A PGD(2)-U10 ADP must be used if External Paging is required in the Secondary Systems.
- License information in the Primary will be copied to the Secondary site when doing database duplication.
- Duplicate license information in the Secondary System is available for only 28 days.
- After twenty-eight days, the license expires. To renew the license, a connection to the original Primary site must be re-established. (Once the connection to the Primary is recovered, if fail-over occurs again, the license is once again enabled for twenty-eight days to the new Primary System).
- If the original Primary site is in the NetLink network as a temporary secondary, the license information is available.
- If a user wants to enter another additional feature license, it needs to be entered on the original Primary System.
- When fail-over occurs, the Primary System is changed to another communication server. The IP applications do not know the new primary IP Address, so the following features are disabled after fail-over:
  - ❑ SMDR
  - ❑ -MIS
  - ❑ SIP Terminal
  - ❑ Softphone
  - ❑ IP K-CCIS



- The following Programs are not updated by the Primary System during fail-over:  
Program 10-01, Program 10-02, Program 10-12, Program 10-13, Program 10-14, Program 10-15, Program 10-16, Program 51-01, Program 90-01 or Program 90-09.
- Data in SRAM area is not transferred to the Secondary Systems during fail-over, therefore when fail-over occurs DND and Caller ID History may be lost.
- When a Secondary System with an ETIA or RTB assigned is added to a NetLink network, the Primary Systems database does not replicate the data in Programs 10-55 or 90-61.
- Both the Primary Site and Secondary Sites can have their own local MOH source connected to the CN8 or CN9 on the front of the GCD-CP10.
- The T-1 CCTA and PVA-CCIS blade is supported in the primary system and/or secondary systems.
- When using Mobile Extension in a NetLink Network, the ISDN/PRI must be used in the Primary System.
- When using Set Relocation, and a terminal is re-located from one physical system to another physical system, route programming must be made accordingly for 911 calls.
- FoIP (Fax over IP) is supported in a NetLink Network.
- DT700 series IP terminals and wireless IP terminals can be registered to secondary systems in a NetLink environment, Softphones must still register to the primary only.
- For a network to be suitable for VoIP it must pass specific requirements. To ensure the site meets these requirements, an IP ready check and a site survey must be completed at each site before VoIP implementation.
  - ❑ One-way delay must not exceed 100ms
  - ❑ Round Trip delay must not exceed 200ms
  - ❑ Packet loss must not exceed 1%
  - ❑ Data switches must be manageable
  - ❑ Routers must provide QOS
  - ❑ Adequate bandwidth for estimated VoIP traffic
  - ❑ Depending on how QoS policies are built in the network, assignments may be needed in the CPU

Table 2-114 VoIP Resource Chart

		Primary System				Secondary 1			Secondary 2		
		TDM Terminal	IP Terminal (DT700)	CO Analog /Digital	IP Trunk	TDM Terminal	CO Analog /Digital	IP Trunk	TDM Terminal	CO Analog /Digital	IP Trunk
Primary System	TDM Terminal	0	P:1	0	P:1	P:1 S1:1	P:1 S1:1	P:1 S1:2	P:1 S2:1	P:1 S2:1	P:1 S2:2
	IP Terminal (DT700)	P:1	0	P:1	P:2	S1:1	S1:1	S1:2	S2:1	S2:1	S2:2
Secondary System 1	TDM Terminal	P:1 S1:1	S1:1	P:1 S1:1	P:2 S1:1	0	0	S1:1	P1:1 S2:1	S1:1 S2:1	S1:1 S2:2
Secondary System 2	TDM Terminal	P:1 S2:1	S2:1	P:1 S2:1	P:2 S2:1	S1:1 S2:1	S1:1 S2:1	S2:1 S1:2	0	0	S2:1

P = Primary

S1 = Secondary System #1

S2 = Secondary System #2

- The number of conference blocks in a NetLink network is the same as a stand-alone system.
- **Invalid data** is displayed in the LCD of the terminal if Program 51-01 is enabled.
- When installing a Secondary System in a Netlink network and the Secondary System has GCD-LCA blades installed, the GCD-LCA blades will come online and assign ports before any GCD-DLCA blades are assigned.
- Always connect to the Primary System when using PCPro.
- The following programs require a reset after making a change using PCPro, WebPro or Handset programming:

Table 2-115 CPU Reset Programs

Program	When Changed Using
10-12-01	Handset, WebPro, PCPro
10-12-02	Handset, WebPro, PCPro
10-12-09	Handset, WebPro, PCPro
51-01-01	Handset, WebPro, PCPro
51-15	WebPro, Handset Programming
84-03-06	Handset, WebPro, PCPro
90-04	Handset Programming

Table 2-115 CPU Reset Programs (Continued)

Program	When Changed Using
90-58	Handset Programming
10-46-07	PcPro
84-23	Handset, WebPro, PCPro

- When network communication is down, an alarm is sent to the Attendant terminal informing of the communication error on the network. Improvements also allow for a defined number of network outages per clock hour before failing over.
- When the Attendant telephone exists on a secondary system, alarm information is not displayed on the Attendant telephone.
- When Fail Over occurs between the Primary System and two or more Secondary Systems, the Attendant telephone displays the System ID of the system that went into Fail-Over last.
- When using InMail in a CCIS or Netlink network, 8-digit extensions and mailboxes are not supported.
- The SV9100 can recognize each system where the DT700 extension(s) are connected and provide an Automatic Route Selection (ARS) COS based on the System (System ID) when using NetLink.
- When NetLink is enabled, synchronous ringing (Program 14-02-17) is automatically disabled. Synchronous ringing is not supported in a NetLink environment.
- All nodes in a NetLink network should have the same setting in Program 51-01-04.
- The internal DHCP server in a Remote Netlink site on SV9100 is supported.

**Restrictions**

- Netlink is only supported between SV9100 systems.
- Netlink is not supported between SV8100 and SV9100 systems.
- The number of total ports depends on the Primary System.
- System ID (Program 51-01-02) must be unique for each system in a NetLink network.
- MIS can connect to the Primary (Main) site only.
- Only one Voice Mail can be installed in a NetLink network.
- In-Mail and VRS use the VMDB of the Primary (Main) site.
- APSU can be installed in the Secondary (Remote) System, however the NetLink time zone follows the Primary (Main) System.

- Secondary systems must follow the primary CPU software settings for Mu-law/A-law within the country where the primary system is located. SV9100 NetLink connections are only supported within the same countries/areas. For example, the SV9100 can be connected via NetLink between the US and Canada, however the SV9100 **can not** be connected via NetLink with systems in other countries (e.g., Mexico or the U.K.).
- Synchronous Ringing via NetLink is not supported.

## NetLink Multi-SIP Carrier

### Description

Multiple SIP Trunk carriers can be utilized when NetLink is configured.

A Secondary NetLink system is able to utilize its own SIP trunks independently to the Primary system. Refer to [Figure 2-94 Example – NetLink Multiple Carrier](#) to see the advantage of this feature.

Figure 2-94 Example – NetLink Multiple Carrier

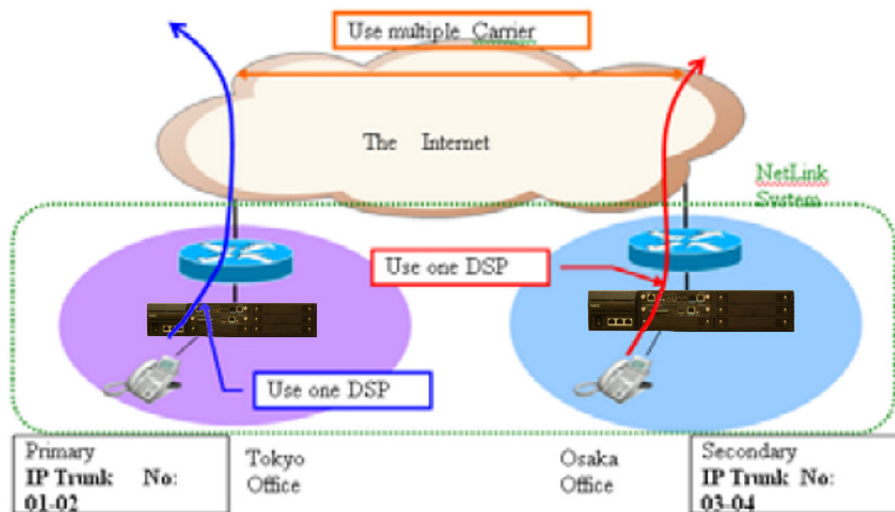

### Conditions

- If SIP Trunk are programmed in a Netlink secondary system, only SIP Profile One can be utilized.
- It is possible to set Register ID for trunks that belong to that specific system. For example, a Register ID set in the Primary system cannot be assigned to a trunk in the Secondary system. The allocation of the trunk and Register ID of Program14-12 must be in the same system.
- In order to use CPN in a secondary system, Program 51-19 must be turned on for those extensions. Once enabled, CPN may be sent on a per station basis using Program 21-19.
- Once NetLink is established, PCPro or WebPro must be used to change the system data related to the SIP trunks.
- Any SIP trunks that are built in a system before establishing NetLink will be deleted after establishing NetLink.
- SIP trunks are assigned in the order of system set up. System ID's are needed to assign Program 10-68 data.

- The following programs no longer replicate and can be set on a per system basis: 10-23, 10-37, 21-19, 84-13, and 84-14.
- Each NetLink secondary system can use either SIP trunks to a provider or SIP trunk TIE line mode but not both.
- Registered SIP trunks can be utilized by any system in the NetLink network as long as trunk route programming allows it.
- When a secondary system becomes the primary after fail over, the SIP trunks will work for the effective license time.
- Program 51-01-04 selects the packet sending method whether each packet is sent immediately or after buffering some packets across the network. This program needs to be set at each system and it is recommended all systems have same setting.

### Default Settings

None

## System Availability

### Terminals

All Terminals

### Required Component(s)

- GCD-CP10 Blade with GPZ-IPLE
- SD-B1(4GB) card
- 0002 – SV9100 NetLink Node Lic

## Related Features

➔ **Automatic Route Selection (ARS)**

## Guide to Feature Programming

The **Level 1**, **Level 2** and **Level 3** columns indicate the programs that are assigned when programming this feature in the order they are most commonly used. These levels are used with PCPro and WebPro wizards for feature programming.

- ❑ Level 1 – these are the most commonly assigned programs for this feature.
- ❑ Level 2 – these are the next most commonly assigned programs for this feature.
- ❑ Level 3 – these programs are not often assigned and require an expert level working knowledge of the system to be properly assigned.

◇ *The items highlighted in gray are read only and cannot be changed.*

Program Number	Program Name/Description	Input Data	Default	Level		
				1	2	3
10-12-03	<b>GCD-CP10 Network Setup – Default Gateway</b> Define the default gateway to be used by the GPZ-IPLE interface.	0.0.0.0 ~ 126.255.255.254 128.0.0.1 ~ 191.255.255.254 192.0.0.1 ~ 223.255.255.254	0.0.0.0	✓		
10-12-09	<b>GCD-CP10 Network Setup – IP Address</b> Set IP address for GPZ-IPLE.	0.0.0.0 ~ 126.255.255.254 128.0.0.1 ~ 191.255.255.254 192.0.0.1 ~ 223.255.255.254	172.16.0.10	✓		
10-12-10	<b>GCD-CP10 Network Setup – Subnet Mask</b> Define the Media Gateway Subnet Mask Address.	128.0.0.0   192.0.0.0   224.0.0.0   240.0.0.0   248.0.0.0   252.0.0.0   254.0.0.0   255.0.0.0   255.128.0.0   255.192.0.0   255.224.0.0   255.240.0.0   255.248.0.0   255.252.0.0   255.254.0.0   255.255.0.0   255.255.128.0   255.255.192.0   255.255.224.0   255.255.240.0   255.255.248.0   255.255.252.0   255.255.254.0   255.255.255.0   255.255.255.128   255.255.255.192   255.255.255.224   255.255.255.240   255.255.255.248   255.255.255.252   255.255.255.254   255.255.255.255	255.255.0.0	✓		
10-12-18	<b>GCD-CP10 Network Setup – CCPU MTU</b> Define the MTU size for the packets sent from IP address defined in Program 10-12-01.	1000 ~ 1500	1450		✓	
10-12-19	<b>GCD-CP10 Network Setup – IPL MTU</b> Define the MTU size for the packets sent from IP address defined in Program 10-12-09.	1000 ~ 1500	1450		✓	

Program Number	Program Name/Description	Input Data	Default	Level		
				1	2	3
51-01-01	<b>NetLink System Property Setting – NetLink System ID</b> This is the ID of each NetLink system. Set to insure that no overlap occurs between nodes.	0 ~ 50 (0 = No operation)	0	✓		
51-01-02	<b>NetLink System Property Setting – Primary Candidate Order</b> When the Primary system is turned off or disconnect from network, this value is used to select a new Primary system. Smaller number is higher priority. If this value is the same number, the System ID (Program 51-01-01) is referred, and the system which has the smaller number is selected as Primary system.	1 ~ 50	30		✓	
51-01-03	<b>NetLink System Property Setting – Secondary System Flag</b> If set to 0, NetLink is dynamically established based on Node List in Program 51-03-01. Primary System is selected in the order the system wakes up. If set to 1, the system connects with Top Priority Primary System. If Top Priority Primary System is not found, the system searches Primary System like this is set to 0.	0 = Disable 1 = Enable	0	✓		
51-01-04	<b>NetLink System Property Setting – Signal Transmit Method</b> 0 = Immediate This default setting does not use the Nagle Algorithm. When enabled, data packets are immediately sent across the network with no buffering delay. 1 = Buffering Nagle Algorithm enabled. Small data packets are not transmitted immediately across the network. The smaller data packets will be buffered and then sent across as larger data packets decreasing the number of packets sent across the network. When the number of packets sent across the network decreases, the amount of bandwidth also decreases.	0 = Immediate 1 = Buffering	1		✓	
51-02-01	<b>NetLink System Basic Setup – System Name</b> Enter the name given to each system.	Maximum of 20 characters.	No Setting		✓	
51-02-02	<b>NetLink System Basic Setup – Primary System Clock Hour Offset</b> Determine the time offset from the Primary system. (0 = -12, 1 = -11, 2 = -10.... 24 = +12) This setting affects Time Display on MLT (see Program 51-13-02).	0 ~ 24	12		✓	



Program Number	Program Name/Description	Input Data	Default	Level		
				1	2	3
51-02-04	<p><b>NetLink System Basic Setup – Authenticate System MAC Address</b></p> <p>Set Program 51-13-03 to 1 (enable). NetLink systems reject the connection from unauthenticated system access.</p>	00-00-00-00-00-00 ~ FF-FF-FF-FF-FF-FF	00-00-00-00-00-00		✓	
51-03-01	<p><b>NetLink Internet Protocol Address List Setting – Internet Protocol Address List</b></p> <p>The system seeks the Primary system based on this list.</p> <p>When there is no Primary system yet, or Fail Over occurs, Node List is referred to establish new link. This setting is necessary when Program 51-01-03 is 0, or Program 51-05-02 is other than 0.</p> <p>Once the system connects to the Primary System, this setting is updated by the Primary system when Program 51-13-01 is On. So, enter IP address of the systems which may become Primary at least.</p>	0.0.0.0 ~ 126.255.255.254 128.0.0.1 ~ 191.255.255.254 192.0.0.1 ~ 223.255.255.254	0.0.0.0	✓		
51-04-01	<p><b>IP Address Setting of Top Priority Primary System of Net-Link – Internet Protocol Address of Top Priority Primary</b></p> <p>Enter the IP address of the Top Priority Primary System.</p> <p>To use this feature, set Program 51-06-01 to 1(On).</p>	0.0.0.0 ~ 126.255.255.254 128.0.0.1 ~ 191.255.255.254 192.0.0.1 ~ 223.255.255.254	0.0.0.0	✓		
51-05-01	<p><b>NetLink Timer Settings – Keep Alive Sending Interval</b></p> <p>This is the Keep Alive sending time from the Secondary system to confirm communication with the Primary system.</p>	1 ~ 3600 seconds	5		✓	
51-05-02	<p><b>NetLink Timer Settings – Keep Alive Response Waiting Time</b></p> <p>This is the time the Secondary system waits for a response from the Primary system before cutting off communication.</p>	0, 5 ~ 10800 seconds (0 = infinity)	20		✓	
51-05-03	<p><b>NetLink Timer Settings – Primary Search Packet Sending Interval</b></p> <p>While searching the Primary system, the system sends a packet at this time.</p>	1 ~ 3600 seconds	5		✓	
51-05-04	<p><b>NetLink Timer Settings – Primary Search Time Maximum Value</b></p> <p>Total time of Primary system seek time.</p>	0, 5 ~ 10800 seconds	20		✓	
51-05-05	<p><b>NetLink Timer Settings – Top Priority Primary Detection Packet Sending Interval</b></p> <p>When current Primary system is not Top Priority Primary System, the system sends packet to check if Top Priority System exists.</p>	1 ~ 3600 seconds	10		✓	

Program Number	Program Name/Description	Input Data	Default	Level		
				1	2	3
51-05-06	<p><b>NetLink Timer Settings – Primary Compulsion Specification Trial Maximum Time</b></p> <p>When the forced change Primary command is executed, the system searches the new Primary system for this time.</p>	1 ~ 10800 seconds	30		✓	
51-05-07	<p><b>NetLink Timer Settings – Socket Refresh Time</b></p> <p>If the IP connection becomes unstable, the keep-alive function does not work. To avoid this, if there is no data traffic for this time, the socket is refreshed.</p>	20 ~ 3600 seconds	40		✓	
51-06-01	<p><b>NetLink Primary Automatic Integration Setting – Primary Integration Right or Wrong</b></p> <p>When LAN cable was divided, multiple Primary systems may appear. If the LAN connection is recovered, multiple NetLinks exist in the network. When this option is enabled, NetLink is composed around Top priority Primary System.</p>	0 = Off 1 = On	0	✓		
51-06-02	<p><b>NetLink Primary Automatic Integration Setting – Package Reset Timing Option</b></p> <p>When Primary System Automatic Integration is done, all packages of secondary systems reset. This option can select the timing of package reset.</p>	0 = Reset when all packages are in idle condition 1 = Anytime	0		✓	
51-07-01	<p><b>NetLink Primary Compulsion Specification Setting – Forced Change Primary System Enabling</b></p> <p>Set this item whether the Forced Change Primary is available or not.</p>	0 = Disable 1 = Enable	1		✓	
51-07-02	<p><b>NetLink Primary Compulsion Specification Setting – Package Reset Timing Option</b></p> <p>When Forced Change Primary System is done, all packages reset. This option can select the timing of package reset.</p> <p>0 = Reset when all packages are idle, otherwise reject Primary System Integration. 1 = Anytime</p>	0 = Off 1 = On	0		✓	
51-08-01	<p><b>Primary NetLink Setting – IP Address of New Primary System</b></p> <p>Enter target IP address for New Primary system. When the Forced Change Primary system is done, this setting is erased.</p> <p>➡ <i>This program is available only via telephone programming and not through PC Programming.</i></p>	0.0.0.0 ~ 126.255.255.254 128.0.0.1 ~ 191.255.255.254 192.0.0.1 ~ 223.255.255.254	0.0.0.0		✓	

Program Number	Program Name/Description	Input Data	Default	Level		
				1	2	3
51-08-02	<p><b>Primary NetLink Setting – System ID of New Primary System</b></p> <p>When set to 0, top priority Primary system is assumed to be the new Primary system.</p> <p>➔ <i>This program is available only via telephone programming and not through PC Programming.</i></p>	0 ~ 50	No Setting		✓	
51-09-01	<p><b>NetLink Communication Port Settings – Primary Waiting Port</b></p> <p>Set the communication port that the Primary system uses to communicate with the Secondary system.</p>	0 ~ 65535	58000		✓	
51-09-02	<p><b>NetLink Communication Port Settings – Communication Waiting Port</b></p> <p>Set the Port used to communicate between nodes. It is always opened by all nodes.</p>	0 ~ 65535	58001		✓	
51-09-03	<p><b>NetLink Communication Port Settings – Secondary Communication Port</b></p> <p>Secondary system communicates with Primary system at this port number. If 0 is specified, temporary port is dynamically selected.</p>	0 ~ 65535	0		✓	
51-09-04	<p><b>NetLink Communication Port Settings – Primary Search Port</b></p> <p>When Fail-Over occurred, each system communicates with other system at this port number.</p> <p>If 0 is set, temporary port is selected dynamically.</p> <p>If 0 is not specified, the number and continuous maximum 50 number is used. (e.g. 5000 is specified 5001, 5002...5049 are used).</p>	0 ~ 65535	0		✓	
51-09-05	<p><b>NetLink Communication Port Settings – Primary Detection Port</b></p> <p>Enter port number to seek the Top Priority Primary system.</p> <p>If 0 is specified, temporary port is selected dynamically.</p>	0 ~ 65535	0		✓	
51-09-06	<p><b>NetLink Communication Port Settings – Database Replication Communication Listening Port</b></p> <p>Set the port used to replicate database.</p>	0 ~ 65535	58002		✓	
51-09-07	<p><b>NetLink Communication Port Settings – Database Replication Primary Detection Port</b></p> <p>Set the port used to replicate database.</p> <p>If 0 is specified, temporary port is selected dynamically.</p>	0 ~ 65535	0		✓	

Program Number	Program Name/Description	Input Data	Default	Level		
				1	2	3
51-10-01	<b>Virtual Slot Setting – Number of Available Virtual Slots</b> 240 slots can be controlled in NetLink. This command can check how many slots are available.	240 slots can be controlled in NetLink. This command can check how many slots are available.	No Setting			✓
51-11-01	<b>NetLink System Information – System Name</b> For reference only.	For reference only.	No Setting			✓
51-11-02	<b>NetLink System Information – Connected State</b> For reference only.	For reference only.	0			✓
51-11-03	<b>NetLink System Information – IP Address</b> For reference only.	For reference only.	000.000.000.000			✓
51-11-04	<b>NetLink System Information – MAC Address</b> For reference only.	For reference only.	00:00:00:00:00:0 0			✓
51-11-05	<b>NetLink System Information – Primary Priority Level</b> For reference only.	For reference only.	0			✓
51-11-06	<b>NetLink System Information – Main Software Version</b> For reference only.	For reference only.	XX.XX			✓
51-12-01	<b>Primary System Information – System ID</b> For reference only.	For reference only.	0			✓
51-12-02	<b>Primary System Information – System Name</b> For reference only.	For reference only.	No Setting			✓
51-12-03	<b>Primary System Information – IP Address</b> For reference only.	For reference only.	000.000.000.000			✓
51-12-04	<b>Primary System Information – MAC Address</b> For reference only.	For reference only.	00:00:00:00:00:0 0			✓
51-12-05	<b>Primary System Information – Primary Priority Level</b> For reference only.	For reference only.	0			✓
51-12-06	<b>Primary System Information – Main Software Version</b> For reference only.	For reference only.	XX.XX			✓
51-13-01	<b>NetLink Options – Automatic IP Address List Operation Update</b> When set to 1, the list in Program 51-03-01 is automatically updated.	0 = Disable (Off) 1 = Enable (On)	1	✓		

Program Number	Program Name/Description	Input Data	Default	Level		
				1	2	3
51-13-02	<b>NetLink Options – Time Zone Option</b> When set to 0, the following features are affected: Clock Display, Incoming/Outgoing History List. When set to 1, the following features are affected: VRS Time Announce, Date and Time Setting Service Code, Alarm Clock setting.	0 = Disable (Off) 1 = Enable (On)	0		✓	
51-13-03	<b>NetLink Options – MAC Address Authorization Enable</b> Refer to Program 51-02-04 for setting MAC address.	0 = Disable (Off) 1 = Enable (On)	0		✓	
51-14-01	<b>NetLink System Control – Delete System Information</b> Delete system information and the slot information. The system must be disconnected. ➤ <i>This program is available only via telephone programming and not through PC Programming.</i>	1 ~ 50	1		✓	
51-15-01	<b>Demonstration Setting</b> Automatically set the minimum setting values in NetLink. A system reset occurs after this command is executed. ➤ <i>(This program is available only via telephone programming and not through PC Programming).</i>	1 = Primary automatic setting 2 = Secondary 1 - automatic operation setting 3 = Secondary 2 - automatic operation setting 4 = Secondary 3 - automatic operation setting	No Setting			✓
51-16-01	<b>NetLink System Data Replication Mode Setting – System Data Replication Mode</b> Set the synchronous mode of the system data. When set to 1, the systems are synchronized at the time set in Item 02 below. When set to 2, the systems are synchronized at regular time intervals set in Item 03 below.	0 = Disable 1 = Setting Time Mode 2 = Interval Mode	2		✓	
51-16-02	<b>NetLink System Data Replication Mode Setting – System Data Replication Time Setting</b> Set the time of day that both systems synchronize database (when Item 01 is set to 1).	0000 ~ 2359	0000		✓	
51-16-03	<b>NetLink System Data Replication Mode Setting – System Data Replication Interval Setting</b> Set the time that both systems synchronize database (when Item 01 is set to 2).	15 ~ 1440 minutes	30		✓	
51-16-04	<b>Replication Time Stamp</b> Show next replication time. (Read Only)	Month: 0~12	No Setting			✓
		Day: 0~31				✓
		Hour: 00~23				✓
		Minute: 00~59.				✓

Program Number	Program Name/Description	Input Data	Default	Level		
				1	2	3
51-16-05	<b>NetLink System Data Replication Mode Setting – System Data Replication Wait Time</b> Set the wait time until replication starts when NetLink is created.	1 ~ 86400 seconds	180		✓	
51-16-06	<b>NetLink System Data Replication Mode Setting – System Data Replication Interval</b> Set an interval time to start replication to the next node after replication to one node is completed.	1 ~ 86400 seconds	1		✓	
51-17-01	<b>NetLink DT800/DT700 Server Individual Information Setup – Registrar Port</b> Use to set the SIP Register Port of each system.	0 ~ 65535	5080	✓		
51-17-02	<b>NetLink DT800/DT700 Server Individual Information Setup – Subscribe Session Port</b> Use to set the SIP Subscribe Session Port number of each system when NetLink is used.	0 ~ 65535	5081	✓		
51-18-01	<b>Netlink Configuration Options – Netlink Fail-Over Limit</b> When tear-down of network was repeated more than the specified times, NetLink is operated stand-alone.	0, 2 ~ 10 (0 = Infinity)	0		✓	
51-19-01	<b>NetLink IP Trunk (SIP) Calling Party Number Setup for Extension – NetLink CPN Transmission</b> This program assigns transmission of Calling Party Number (CPN) from Program 21-19 for each secondary system. The transmission applies for every extension.	0 = Disable 1 = Enable	1		✓	
84-26-01	<b>IPL Basic Setup – IP Address</b> Assign the IP address for the DSP on the GPZ-IPLE.	xxx.xxx.xxx.xxx	Slot 1 = 172.16.0.20	✓		
84-26-02	<b>IPL Basic Setup – RTP Port Number</b> Assign the RTP port number to be used for each DSP on the GPZ-IPLE. ➡ <i>Only even numbered ports are supported.</i>	0 ~ 65534	VoIP GW1 = 10020		✓	
84-26-03	<b>IPL Basic Setup – RTCP Port Number (RTP Port Number +1)</b> Assign the RTCP Port number to used for each DSP on the GPZ-IPLE.	0 ~ 65534	VoIP GW1 = 10021		✓	

## Operation

None

## SV9100 PoE Gigabit Switch

### Description

The NEC PoE Gigabit Switch (GSWU) is a fully managed switch which brings gigabit speeds to users while adding a whole new level of intelligence and security to networks.

The eight 10/100/1000 Mbps ports enable users to take advantage of the Gigabit Ethernet interfaces. The NEC PoE Gigabit Switch supporting the UNIVERGE SV9100 and SV8300 system.

All user ports can support up to Gigabit Ethernet and may also support the primary Layer 2 protocols, with an emphasis on QoS features such as 802.1p and Diffserv.

The GCD-ETIA blade has eight RJ45 ports for 10 BASE-T, 100 BASE-TX and 1000 Base-T along the front. The GCD-ETIA design is based on one card and one software build. However, all the cards in the system are managed as a Master/Slave configuration. The Master provides full distributed Layer 2 management to all Ethernet Switch cards in the system.

The GCD-ETIA card can be a standalone card providing eight Gigabit Ethernet PoE ports. However, the real advantage with this card is that additional cards can be “stacked” by external “daisy chain” connections to provide up to 76 contiguous ports (all on the same managed domain/network). Below are the primary features of the card set.

Switches, unlike hubs, use *microsegmentation* to create collision domains, one per connected segment. This way, only the Ethernet devices which are directly connected via a point-to-point link, or directly connected hubs are contending for the medium. By eliminating collisions, full-duplex point-to-point connections on the switch are possible.

When multiple blades requiring Ethernet data connections are installed in an UNIVERGE SV9100 chassis, the GCD-ETIA can provide a neat and simple installation.

The GCD-ETIA is an in-skin, fast Ethernet switching hub unit that provides the following services:

- Eight 10/100/1000 Gigabit Ethernet ports
- PoE  
802.3af compliant, supplies up to IEEE standard maximum 15.4W on eight 10/100/1000 ports Link/ACT, POE System
- Simplified QoS management using 802.1p, Diffserv or ToS traffic prioritization specifications
- Granular security and QoS implementation
- 802.1Q based VLANs enable segmentation of networks for improved performance and security
- VLAN  
Port Based and 802.1Q Tag-based VLANS Management VLAN
- Automatic configuration of VLANs across multiple switches through GVRP/ GARP
- Auto MDI/MDIX

- Port Mirroring  
Traffic on a port can be mirrored to another port for analysis with a network analyzer
- Firmware Upgrade
- Built in Web UI for easy browser-based configuration (HTTP)
- Rate Limiting
- Ingress Policer
- Egress rate control

### Stacking (SV9100 Chassis Only)

The idea of stacking allows the user the ability to manage multiple GSWU cards in one system as one switch, instead of individual units and IP addresses, etc. For example, a set of three cards would appear to the UI as a 24-port switch, instead of three 8-port switches.

Stacking will work by assigning a Master Management Card (or Main card), which will provide all the GUI information for all cards in the same stack. The CCPU will assign the Main card by issuing an IP address and configuring the Main Card assignment to the GSWU via data program. All other GSWU cards detected in the system will not be assigned an IP address and will be configured as “Add-on”, signifying them as Add-on cards.

A PBX system can have up to 12 GSWU cards per system. However, only three GSWU units can be grouped together to form a single 20-port switch. When more than three GSWU units are present within a system, the units other than the three designated will not have any of the software features specified in this document. They will behave as unmanaged Gigabit Ethernet switches.

### Unmanaged Switch Functions

In the Unmanaged mode, a GSWU unit will have following functions only:

- 10/100/1000 Ethernet ports (x8)
- PoE Class 1 (lowest power class)

### Stacking Network Configuration

The GSWU Main board will maintain the network configuration and card initialization sequence. The provision of IP address from the back plane will identify the Main board. If, during initialization, the IP address is set to “0” by the CPU, then the card is determined to be an “Add-on” card.

The IP address for the GSWU will be assigned in program Program 10-55 on the SV9100. It contains settings for IP Address, Subnet Mask and a gateway IP address.

### Stacking Formation

When a GSWU determines that it is an “Add-on” by the configuration setting in Program 10-55-03, the Add-on GSWU will send a broadcast message to all the GSWU units in the Chassis, until it receives an acknowledge message from a Main board.



The Main board receiving this broadcast message will acknowledge by sending port identification information to the Add-on board and a board type (i.e. Add-on 1, Add-on 2, etc.).

The board type will identify the Add-on board to system (Main GSWU) of its port assignments. A board type of “Add-on 1” will be Ports 9~16. A board type of “Add-on 2” will be Ports 17~24. A GSWU that has been designated as the “Main” board will always be assigned Ports 1~8.

### Stacking Port Number Determination

When a Main board is initialized, it assigns the first eight ports as port 1 through 8. When subsequent add-on boards’ broadcast messages are received, the CCPU, by manual means or any other means, will assign a Board Type to the Add-on card. This will automatically assign its port numbers.



NOTE

*On power up, all GSWU boards are assigned as Main boards, or generic Add-on boards (by no IP address or IP address of 0). In order to include the Add-on boards as part of the managed stack and assign port numbers, the CCPU will send a “Board Type” message to the Add-on card. This will identify the port assignment of the Add-on card to the Main card for stacking.*

The grouping of the three GSWU units to form a 20-port switch is restricted to reside in a single system location. Stacking is not supported for those GSWU units in remote locations supporting the NetLink feature.

### Conditions

- When Auto Negotiation is denied and port speed is set to 100Mbps, the yellow LED (located on the RJ45 connector) is **ON**. When port speed is set to 10Mbps, this LED is **OFF**.
- The number of supported GCD-ETIA blades are to be determined by the power consumption chart. Reference Hardware manual for more details.
- When linking multiple GCD-ETIA cards each card must be statically assigned an IP address and each blade must be linked.

### Default Settings

None

## System Availability

### Terminals

None

### Required Components

GCD-ETIA

## Related Features

None

## Guide to Feature Programming

The **Level 1**, **Level 2** and **Level 3** columns indicate the programs that are assigned when programming this feature in the order they are most commonly used. These levels are used with PCPro and WebPro wizards for feature programming.

- Level 1 – these are the most commonly assigned programs for this feature.
- Level 2 – these are the next most commonly assigned programs for this feature.
- Level 3 – these programs are not often assigned and require an expert level working knowledge of the system to be properly assigned.

Program Number	Program Name/Description	Input Data	Default	Level		
				1	2	3
10-55-01	<b>Package Network Setup – IP Address</b> Define the IP Address for the GCD-ETIA. ➡ When the blade is deleted from the system using Program 90-05, the programming for the slot in 10-55 is set back to default.	0.0.0.0 ~ 126.255.255.254 128.0.0.1 ~ 191.255255.254 192.0.0.1 ~ 223.255.255.25	172.16.1.100	✓		
10-55-03	<b>Package Network Setup – Main/Add-on</b> Use the Main setting to distribute an IP Address to the blade.	0 = Main 1 = Add-on	1	✓		
10-55-04	<b>Package Network Setup – Sub Net Mask</b> Define the subnet mask for the GCD-ETIA.	128.0.0.0   192.0.0.0   224.0.0.0  240.0.0.0   248.0.0.0   252.0.0.0  254.0.0.0   255.0.0.0  255.128.0.0   255.192.0.0  255.224.0.0   255.240.0.0  255.248.0.0   255.252.0.0  255.254.0.0   255.255.0.0  255.255.128.0   255.255.192.0  255.255.224.0   255.255.240.0  255.255.248.0   255.255.252.0  255.255.254.0   255.255.255.0  255.255.255.128  255.255.255.192  255.255.255.224  255.255.255.240  255.255.255.248  255.255.255.252  255.255.255.254  255.255.255.255	255.255.0.0	✓		
10-55-05	<b>Package Network Setup – Default Gateway</b> Define the default gateway for the GCD-ETIA.	0.0.0.0 ~ 126.255.255.254 128.0.0.1 ~ 191.255255.254 192.0.0.1 ~ 223.255.255.254	0.0.0.0	✓		

Program Number	Program Name/Description	Input Data	Default	Level		
				1	2	3
84-26-01	<b>IPL Basic Setup – IP Address</b> Assign the IP address for the DSP on the GPZ-IPLE.	xxx.xxx.xxx.xxx	Slot 1 = 172.16.0.20		✓	

## Operation

None

## SV9100 Terminals

### Description

The SV9100 is a full-featured IP based communications system providing a rich feature set with pure Voice over IP (VoIP) communications, across corporate Local and Wide Area Networks (LAN and WAN).

The DT700/DT800 series telephones provide a converged infrastructure at the desktop, with a 10Base-T/100Base-TX connection to the LAN and built-in hub for a PC connection to the telephone itself. The system can provide peer to peer connections between the DT700/DT800 series telephones with voice compression, offering existing IP telephone features with an enhanced user interface. On the WAN side, the system can provide peer to peer connections over IP networks with the voice compression, on CCIS over IP or Remote Unit over IP.



IMPORTANT

*Remote Unit over IP is available only for the SV9300.*

The SV9100 can provide legacy line/trunk interfaces to support the existing Time Division Multiplexing (TDM) based infrastructure, such as analog telephones, digital telephones (DT300/DT400 series), analog networks and digital networks (T1/E1, ISDN, etc.).

### Encryption

This feature is supported with main software V 2.5 or above and terminal firmware 92.2.1.0 or above.



NOTE

*SV9100 supports AES 128 bit encryption. Program 10-46-08 Model1 (read only) represents AES 128 bit.*

Table 2-116 DT700 Supported Encryption

Source	Destination	S RTP	Comment
DT700	DtermIP	S	<b>DT700 VoIPDB Encrypt between DT700 and VoIPDB</b>
DT700	STD SIP (P2P)	N	
DT700	STD SIP (Non P2P)	S	<b>DT700 VoIPDB Encrypt between DT700 and VoIPDB</b>
DT700	DT700	S	
DT700	PSTN	S	<b>DT700 VoIPDB Encrypt between DT700 and VoIPDB</b>
DT700	IP Network (SIP/H323/CCIS)	S	<b>DT700 VoIPDB Encrypt between DT700 and VoIPDB</b>

Table 2-116 DT700 Supported Encryption (Continued)

Source	Destination	SRTP	Comment
DT700 Encryption On	DT700 Encryption Off	N	

**S = Supported**  
**N = Not Supported**

Figure 2-95 SV9100 Encryption Configuration

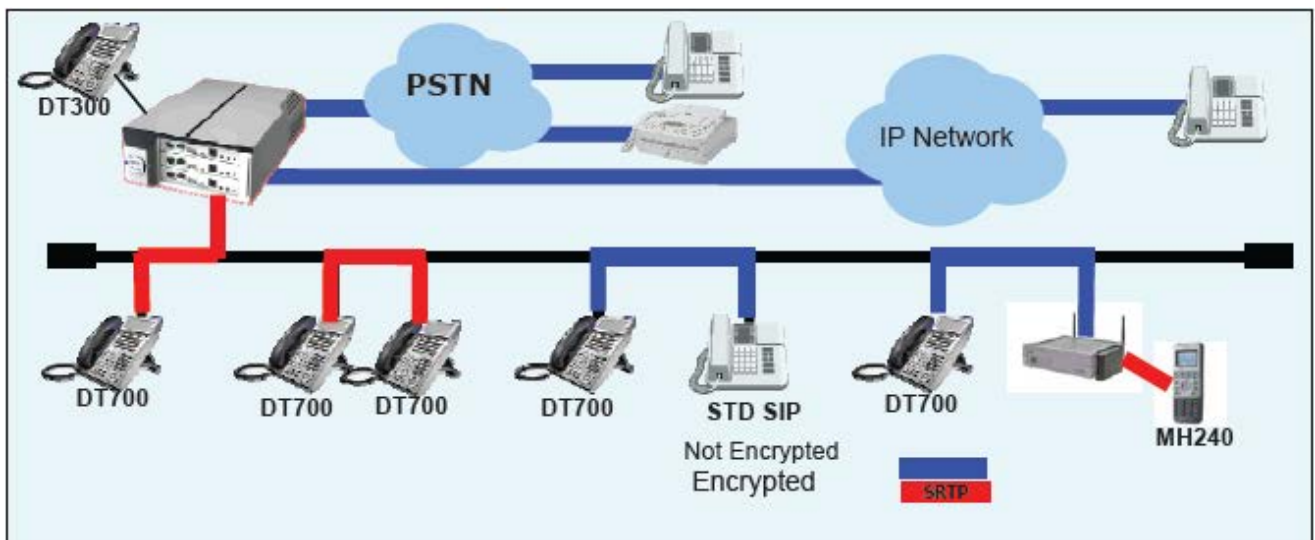

Table 2-117 SV9100 Supported Terminals

Terminal Group	New Terminals DT400/DT800 UT880	DT300/DT700	Series i	Series E and Prior
SV9100	Yes	Yes	No	No

### Conditions

- The system can be programmed to blink the page number of a DT300/DT700 DESI-Less terminal when it receives an incoming call, or switch to the page the incoming call is on. Furthermore, a default page can be defined for the DESI-Less terminal to change to when it goes idle or when it has answered a call.
- DESI-Less screen page switching only applies to idle terminals. If a terminal is not idle, the screen will not switch if another call comes in until the phone goes idle.
- The Electronic Headset Switch (EHS) is only supported on the ITL/DTL-8LD, ITL/DTL-12/

24 and ITL-320C terminals.

- The EHS and 8LK are not supported on the same SV9100 terminal.
- [Table 2-118 Terminal Category Reference Chart on page 2-1546](#) provides a quick reference of the DT series Digital and IP multiline terminals.

Table 2-118 Terminal Category Reference Chart

Series Name		Equipment ID	Comments
DT300 Series Digital Terminal (TDM)	DT310 (Economy)	DTL-2E-( )	○ Economical terminal providing access to basic telephony and messaging service
		DTL-6DE-( )	○ Fully functional keypad providing standard business functions such as hold, transfer, speaker, microphone and other features
		DTL-12E-( )	○ 2-button terminal is non-display ○ 6-button terminal equipped with LCD and full-featured keypad ○ 12-button terminal is non-display ○ Available in black
	DT330 (Value)	DTL-8LD-( )	○ 8-button DESI-Less LCD telephone
DTL-12D-( )		○ Also available are 12-, 24-, 32-button LCD telephones	
DTL-24D-( ) DTL-32-D-( )		○ Provides access to more sophisticated system features and allowing room for growth ○ All DT 330s come with a standard LCD display, full duplex speakerphone capability, module support for expansion and feature add-on capability ○ Optional 60-button DSS Console provides 60 programmable keys and provides users a Busy Lamp Field (BLF) and 1-button access to extensions, trunks, and system features ○ Available in black and white	
	DTL-12BT( )	○ Bluetooth available in black	
	DTL-12PA( )	○ Power Save Adapter provides backup for analog trunk connection	
DT400 Series Digital Terminal (TDM)	DT410 (Economy)	DTZ-2E-( )	○ Economical terminal providing access to basic telephony and messaging service
		DTZ-6DE-( )	○ Fully functional keypad providing standard business functions such as hold, transfer, speaker, microphone and other features
		DTZ-12D-( )	○ 2-button terminal is non-display ○ 6-button terminal equipped with LCD and full-featured keypad ○ Available in black
	DT430 (Value)	DTZ-8LD-( )	○ 8-button DESI-Less LCD telephone
DTZ-12D-( ) DTZ-24D-( )		○ Also available are 12-, 24-, 32-button LCD telephones ○ Provides access to more sophisticated system features and allowing room for growth ○ All DT 430s come with a standard LCD display, full duplex speakerphone capability, module support for expansion and feature add-on capability ○ Optional 60-button DSS Console provides 60 programmable keys and provides users a Busy Lamp Field (BLF) and 1-button access to extensions, trunks, and system features ○ Available in black and white	

Table 2-118 Terminal Category Reference Chart

Series Name		Equipment ID	Comments
DT700 Series IP Terminals	DT710 (Economy)	ITL-2E-( ) ITL-6DE-( ) ITL-8LDE-( )	<ul style="list-style-type: none"> <li>○ Economical terminal providing access to basic telephony and messaging service</li> <li>○ Fully functional keypad providing standard business functions such as hold, transfer, speaker, microphone and other features</li> <li>○ 2-button terminal is non-display</li> <li>○ 6-button terminal equipped with LCD and full-featured keypad</li> <li>○ 8-button terminal equipped with LCD and full-featured keypad</li> <li>○ Available in black</li> <li>○ IP formatted terminal has a dual port, supports compression, full-duplex handsfree operation</li> </ul>
	DT730 (Value)	ITL-8LD-( ) ITL-12D-( ) ITL-24D-( ) ITL-32-D-( )	<ul style="list-style-type: none"> <li>○ 8-button DESI-Less LCD telephone</li> <li>○ Also available are 12-, 24-, 32-button LCD telephones</li> <li>○ Provides access to more sophisticated system features allowing room for growth</li> <li>○ All DT 730s come with a standard backlit LCD display, full duplex speakerphone capability, module support for expansion and feature add-on capability</li> <li>○ Available in black and white</li> <li>○ Expands the capability by providing XML display to provide more productivity enhanced applications to the users</li> <li>○ Optional 60-button DSS Console provides 60 programmable keys and provides users a Busy Lamp Field (BLF) and 1-button access to extensions, trunks, and system features</li> </ul>
		ITL-12PA( )	<ul style="list-style-type: none"> <li>○ Power Save Adapter provides backup for analog trunk connection</li> </ul>
	DT730G (Value)	ITL-12CG-( ) ITL-12DG-( )	<ul style="list-style-type: none"> <li>○ Provides access to more sophisticated system features allowing room for growth</li> <li>○ DT 730G terminals come with a standard back-lit LCD display, full duplex speakerphone capability, module support for expansion and feature add-on capability</li> <li>○ Available in black only</li> <li>○ Expands the capability by providing XML display to provide more productivity enhanced applications to the users</li> <li>○ 12CG equipped with color LCD display</li> <li>○ 12CG/12DG support Gigabit Ethernet</li> </ul>
	DT750 (Sophisticated)	ITL-320C-( )	<ul style="list-style-type: none"> <li>○ IP terminal provides a 5" color touch panel</li> <li>○ Features of the telephone provide easy use of NEC Unified communications and third-party telephony XML applications</li> <li>○ Access to 32 telephony feature lines across an IP backbone, built-in full duplex speakerphone and DESI-Less line key labeling are standard</li> <li>○ Optional 60-button DSS Console provides 60 programmable keys and provides users a Busy Lamp Field (BLF) and one-button access to extensions, trunks, and system features</li> </ul>
<b>Wireless Handset</b>		G955	SIP DECT
		G266	SIP DECT
		G566	SIP DECT
		ML440	SIP DECT
<b>Cordless</b>		DTL-8R-1	Cordless DECT
		DTZ-8R-1	Cordless DECT

Table 2-118 Terminal Category Reference Chart

Series Name		Equipment ID	Comments
DT800 Series IP Terminals	DT820 (Entry)	ITY-6D-( ) ITY-8LDX-( )	<ul style="list-style-type: none"> <li>○ 6-button terminal equipped with LCD and full-featured keypad</li> <li>○ 8-button DESI-Less LCD telephone</li> <li>○ All DT 820s come with a standard backlit LCD display, full duplex speakerphone capability, module support for expansion and feature add-on capability</li> <li>○ Available in black only</li> </ul>
	DT830 (Value)	ITZ-8LD-( ) ITZ-8LDG-( ) ITZ-12D-( ) ITZ-24D-( )	<ul style="list-style-type: none"> <li>○ 8-button DESI-Less LCD telephone</li> <li>○ Also available are 12-, 24-, 32-button LCD telephones</li> <li>○ Provides access to more sophisticated system features allowing room for growth</li> <li>○ All DT 830s come with a standard backlit LCD display, full duplex speakerphone capability, module support for expansion and feature add-on capability</li> <li>○ Available in black and white</li> <li>○ Expands the capability by providing XML display to provide more productivity enhanced applications to the users</li> <li>○ Optional 60-button DSS Console provides 60 programmable keys and provides users a Busy Lamp Field (BLF) and 1-button access to extensions, trunks, and system features</li> </ul>
	DT830G (Value)	ITZ-12CG-( ) ITZ-12DG-( )	<ul style="list-style-type: none"> <li>○ Provides access to more sophisticated system features allowing room for growth</li> <li>○ DT 830G terminals come with a standard back-lit LCD display, full duplex speakerphone capability, module support for expansion and feature add-on capability</li> <li>○ Available in black only</li> <li>○ Expands the capability by providing XML display to provide more productivity enhanced applications to the users</li> <li>○ 12CG equipped with color LCD display</li> <li>○ 12CG/12DG support Gigabit Ethernet</li> </ul>



- [Table 2-119 Connectivity of Options \(DT300/DT700\)](#) and [Table 2-120 Connectivity of Options \(DT400/DT800\)](#) on page 2-1550 provide a quick overview of the options available with the DT Series terminals.

Table 2-119 Connectivity of Options (DT300/DT700)

Terminal Options		IP Terminals			Digital Terminals	
		Sophisticated ITL-320C-1 TEL	Value ITL-8LD-1 ITL-12D-1 ITL- 12CG-3 ITL- 12DG-3 ITL- 24D-1 ITL- 32D-1	Economy ITL-2E-1 ITL- 6DE-1 ITL-8LDE-1	Value DTL-8LD-1 DTL-12D-1 DTL-24D-1 DTL-32D-1	Economy DTL-2E-1 DTL-6DE-1 DTL-12E-1
Key Kit	Ten Key Kit	✓	✓	✓	✓	✓
	12LK Kit	N/A (Built in)	✓ (Except 8LD-1 Unit)	N/A	✓ (Except 8LD-1 Unit)	N/A
	8LK Unit	✓	✓	N/A	✓	N/A
	EHS	✓	✓ (Except 32D-1 Unit)	N/A	✓ (Except 32D-1 Unit)	N/A
Common	ADA: Analog Recording Adapter	✓	✓	N/A	✓	N/A
	PSA: PSTN Adapter for analog	✓	✓	N/A	✓	N/A
	DSS: 60-Button DSS Console	✓	✓	N/A	Connect to Digital Port on KTS	
Digital	APR: Analog Port adapter with Ringer				✓	N/A
	DESI-Less LK/LCD Unit				✓ (Except 8LD-1 Unit)	N/A
	Backlit LCD				✓ (Except 8LD-1 Unit)	N/A
IP	DESI-Less LK/LCD Unit	N/A (Built in)	✓ (Except ITL-12CG-3 ITL-12DG-3)	N/A	N/A	

Table 2-120 Connectivity of Options (DT400/DT800)

Terminal Options		IP Terminals		Digital Terminals	
		Entry ITY-6D-1 ITY-8LDX-1	Value ITZ-8LD-3 ITZ-8LDG-3 ITZ-12D-3 ITZ-24D-3 ITZ-12CG-3 ITZ-12DG-3	Value DTZ-8LD-3 DTZ-12D-3 DTZ-24D-3	Economy DTZ-2E-3 DTZ-6DE-3
Key Kit	Ten Key Kit	N/A	✓	✓	✓
	12LK Kit	N/A	ITZ-12CG/12DG only	✓ (Except 8LD-3 Unit)	N/A
	8LK Unit	N/A	✓	✓	N/A
Common	ADA: Analog Recording Adapter	N/A	✓	✓	N/A
	DSS: 60-Button DSS Console	N/A	✓	Connect to Digital Port on KTS	
Digital	APR: Analog Port adapter with Ringer			✓	N/A

- [Table 2-121 Terminal and Adapter Compatibility \(DT300/DT700\)](#) and [Table 2-122 Terminal and Adapter Compatibility \(DT400/DT800\)](#) on page 2-1551 show the compatibility between the terminals and adapters used in the system.

Table 2-121 Terminal and Adapter Compatibility (DT300/DT700)

Terminal	Adapter Unit							
	ADA-L	APR-L	ILPA	PSA-L	BCH-L	BHA-L	GBA-L	IPv6-L
<b>Digital Terminals: DT300</b>								
DTL-2E-1 (BK) TEL	—	—	—	—	—	—	—	—
DTL-6DE-1 (BK) TEL	—	—	—	—	—	—	—	—
DTL-12E-1 (BK) TEL	—	—	—	—	—	—	—	—
DTL-8LD(BK)/(WH) TEL	✓	✓	—	✓	✓	✓	—	—
DTL-12BT-1 (BK) TEL	—	—	—	—	—	—	—	—

Table 2-121 Terminal and Adapter Compatibility (DT300/DT700) (Continued)

Terminal	Adapter Unit							
	ADA-L	APR-L	ILPA	PSA-L	BCH-L	BHA-L	GBA-L	IPv6-L
DTL-12D-1 (BK)/(WH) TEL	✓	✓	—	✓	✓	✓	—	—
DTL-12PA-1 (BK) TEL	✓	✓	—	✓	—	—	—	—
DTL-24D-1 (BK)/(WH) TEL	✓	✓	—	✓	✓	✓	—	—
DTL-32D-1 (BK)/(WH) TEL	✓	✓	—	✓	✓	✓	—	—
<b>IP Terminals: DT700</b>								
ITL-2E-1 (BK) TEL	—	—	✓	—	—	—	✓	—
ITL-6DE-1 (BK) TEL	—	—	✓	—	—	—	✓	—
ITL-8LDE-1 (BK) TEL	—	—	✓	—	—	—	✓	—
ITL-8LD-1 (BK)/(WH) TEL	✓	—	✓	✓	—	—	✓	✓
ITL-12D-1 (BK)/(WH) TEL	✓	—	✓	✓	—	—	✓	✓
ITL-12CG-3 (BK) TEL	✓	—	✓	✓	—	—	Note <sup>2</sup>	✓
ITL-12DG-3 (BK) TEL	✓	—	✓	✓	—	—	Note <sup>2</sup>	✓
ITL-12PA-1 (BK) TEL	✓	—	✓	✓	—	—	✓	✓
ITL-24D-1 (BK)/(WH) TEL	✓	—	✓	✓	—	—	✓	✓
ITL-32D-1 (BK)/(WH) TEL	✓	—	✓	✓	—	—	✓	✓
ITL-320C-1 (BK) TEL	✓	—	✓	✓	—	—	✓	✓
<b>Console:</b>								
DCL-60-1 (BK)/(WH) CONSOLE	—	—	—	—	—	—	—	—

— = Option Not Available

✓ = Optional Available

<sup>1</sup> = When the ILPA-R is connected to a 12CG/12DG terminal, maximum connection speed drops to 100Mbps.

<sup>2</sup> = The 12CG/12DG terminals support Gigabit Ethernet, GBA-L Unit not required.

Table 2-122 Terminal and Adapter Compatibility (DT400/DT800)

Terminal	Adapter Unit				
	ADA-L	APR-L	ILPA*	BHA-Z	BCA-Z
<b>Digital Terminals: DT400</b>					
DTZ-2E-3 (BK) TEL	—	—	—	—	—
DTZ-6DE-3 (BK) TEL	—	—	—	—	—

Table 2-122 Terminal and Adapter Compatibility (DT400/DT800) (Continued)

Terminal	Adapter Unit				
	ADA-L	APR-L	ILPA*	BHA-Z	BCA-Z
DTZ-12D-3 (BK)/(WH) TEL	✓	✓	—	✓	✓
DTZ-24D-3 (BK)/(WH) TEL	✓	✓	—	✓	✓
DTZ-8LD-3 (BK)/(WH) TEL	✓	✓	—	✓	✓
<b>IP Terminals: DT800</b>					
ITY-6D-1 (BK) TEL	—	—	—	—	—
ITY-8LDX-1 (BK) TEL	—	—	—	—	—
ITZ-8LD-3 (BK) TEL	✓	—	✓	—	✓
ITZ-12D-3 (BK)/(WH) TEL	✓	—	✓	—	✓
ITZ-24D-3 (BK)/(WH) TEL	✓	—	✓	—	✓
ITZ-12CG-3 (BK)/(WH) TEL	✓	—	✓	—	✓
ITZ-12DG-3 (BK)/(WH) TEL	✓	—	✓	—	✓
ITZ-8LDG-3 (BK)/(WH) TEL	✓	—	✓	—	✓
<b>Console:</b>					
DCZ-60-2 (BK)/(WH) CONSOLE	—	—	—	✓	—

\* = When the ILPA-R unit is used, 1000 BASE-T is not available.

Table 2-123 DT330 Compatibility Settings

ADA-L Unit Switch Settings	Terminal Lot Number DT-330		
	xxx   Lx or lower (Version 1.E0 or lower)	xxx   Mx (Version 8.10)	xxxJSx or higher (Version 2.20 or higher)
ADA Connection for Recording Only.	Dip switches 1, 2, 3, 5, 7 and 8 are OFF. Switches 4 and 6 are ON.	Dip switches 1, 2, 3, 5, 7 and 8 are OFF. Switches 4 and 6 are ON.	Dip switches 1, 2, 3, 5, 7 and 8 are OFF. Switches 4 and 6 are ON.
ADA Connection for Sending Recorded Calls to the Telephone.	Dip switches 2, 3, 5, 7 and 8 are OFF. Switches 1, 4 and 6 are ON.	Dip switches 2, 3, 5, 7 and 8 are OFF. Switches 1, 4 and 6 are ON.	Dip switches 2, 3, 5, 7 and 8 are OFF. Switches 1, 4 and 6 are ON.

Table 2-123 DT330 Compatibility Settings

ADA-L Unit Switch Settings	Terminal Lot Number DT-330		
	xxx I Lx or lower (Version 1.E0 or lower)	xxx I Mx (Version 8.10)	xxxJSx or higher (Version 2.20 or higher)
To Send and Receive to the Terminal	Not supported	Dip switches 1, 2, 3, 5, 7 and 8 are OFF. Switches 4 and 6 are ON.	Dip switches 1, 2, 3, 5, 7 and 8 are OFF. Switches 4 and 6 are ON.

Lot Numbers: I, J – Hardware Revision  
 Lot Numbers: L, M, S – Software Revision

- ➔ To verify DT-330 terminal firmware, hold down keypad buttons 1, 2 and 3 while plugging the line cord into the terminal.

Table 2-124 Firmware Compatibility Matrix

Terminal Lot Number DT-330		BCH-L Unit Lot Number	
		xxxDxx or lower	xxxExx or higher
xxx I xx or lower (Version 8.10 and 1, E0 or lower)	xxx I xx or lower (Version 8.10 and 1, E0 or lower)	Supported	Supported
	xxxJxx or higher (Version 2.20 or higher)	Not supported	Supported

- ➔ BCH Support may differ based on terminal firmware. To verify both DT-330 terminal and BCH-L Unit firmware, hold down keypad buttons 1, 2 and 3 while plugging the line cord into the terminal.
- ➔ Multiple BTH Keys cannot be assigned with the same Desk Terminal key in Program 15-29-01. Each BTH key must be assigned a unique Desk Terminal Key
- [Table 2-125 Terminal and Line Key/LCD Compatibility \(DT300/DT700\)](#) and [Table 2-126 Terminal and Line Key/LCD Compatibility \(DT400/DT800\)](#) on page 2-1555 show the compatibility between the terminals and Line Key or LCD used in the system.

Table 2-125 Terminal and Line Key/LCD Compatibility (DT300/DT700)

Terminal	Line Key/LCD					
	8 LK-L	8LKD(LD)-L	8LKI(LD)-L	12LK-L	LCD (BL)-L	DCL-60
<b>Digital Terminals: DT300</b>						
DTL-2E-1 (BK) TEL	—	—	—	—	—	—
DTL-6DE-1 (BK) TEL	—	—	—	—	—	—
DTL-12E-1 (BK) TEL	—	—	—	—	—	—

Table 2-125 Terminal and Line Key/LCD Compatibility (DT300/DT700) (Continued)

Terminal	Line Key/LCD					
	8 LK-L	8LKD(LD)-L	8LKI(LD)-L	12LK-L	LCD (BL)-L	DCL-60
DTL-8LD(BK)/(WH) TEL	✓	—	—	—	—	✓
DTL-12BT-1 (BK) TEL	✓	✓	—	✓	✓	✓
DTL-12D-1 (BK)/(WH) TEL	✓	✓	—	✓	✓	✓
DTL-12PA-1 (BK) TEL	✓	✓	—	✓	✓	✓
DTL-24D-1 (BK)/(WH) TEL	✓	✓	—	—	✓	✓
DTL-32D-1 (BK)/(WH) TEL	✓	✓	—	—	✓	✓
<b>IP Terminals: DT700</b>						
ITL-2E-1 (BK) TEL	—	—	—	—	—	—
ITL-6DE-1 (BK) TEL	—	—	—	—	—	—
ITL-8LDE-1 (BK) TEL	—	—	—	—	—	—
ITL-8LD-1 (BK)/(WH) TEL	✓	—	—	—	—	✓
ITL-12D-1 (BK)/(WH) TEL	✓	—	✓	✓	—	✓
ITL-12CG-3 (BK) TEL	✓	—	—	✓	—	✓
ITL-12DG-3 (BK) TEL	✓	—	—	✓	—	✓
ITL-12PA-1 (BK) TEL	✓	—	✓	✓	—	✓
ITL-24D-1 (BK)/(WH) TEL	✓	—	✓	—	—	✓
ITL-32D-1 (BK)/(WH) TEL	✓	—	✓	—	—	✓
ITL-320C-1 (BK) TEL	✓	—	—	—	—	✓

— = Option Not Available

✓ = Optional Available

Table 2-126 Terminal and Line Key/LCD Compatibility (DT400/DT800)

Terminal	Line Key/LCD		
	8 LK-Z	16LK-Z	DCL-60
<b>Digital Terminals: DT400</b>			
DTZ-2E-3 (BK) TEL	—	—	—
DTZ-6DE-3 (BK) TEL	—	—	—
DTZ-12D-3 (BK)/(WH) TEL	✓	—	✓
DTZ-24D-3 (BK)/(WH) TEL	✓	—	✓
DTZ-8LD-3 (BK)/(WH) TEL	✓	—	✓
<b>IP Terminals: DT800</b>			
ITY-6D-1 (BK) TEL	—	—	—
ITY-8LDX-1 (BK) TEL	—	—	—
ITZ-8LD-3 (BK) TEL	—	—	—
ITZ-12D-3 (BK)/(WH) TEL	—	—	—
ITZ-24D-3 (BK)/(WH) TEL	—	—	—
ITZ-12CG-3 (BK)/(WH) TEL	✓	—	✓
ITZ-12DG-3 (BK)/(WH) TEL	✓	—	✓
ITZ-8LDG-3 (BK)/(WH) TEL	✓	—	✓

— = Option Not Available

✓ = Optional Available

- [Table 2-127 Terminal and Ten Key Kit Compatibility \(DT300/DT700\)](#) and [Table 2-128 Terminal and Ten Key Kit Compatibility \(DT400/DT800\)](#) on page 2-1557 show the compatibility between the terminals and Ten Key kits used in the system.

Table 2-127 Terminal and Ten Key Kit Compatibility (DT300/DT700)

Terminal	Ten Key Kit				
	BS(F)-L	BS(S)-L	BS (Braille)-L (BK) KIT	BS(Retro)-I	BS (S-Hotel)
<b>Digital Terminals: DT300</b>					
DTL-2E-1 (BK) TEL	—	—	—	✓	—
DTL-6DE-1 (BK) TEL	—	—	—	✓	—
DTL-12E-1 (BK) TEL	—	—	—	✓	—
DTL-8LD(BK)/(WH) TEL	✓	✓	✓	✓	—
DTL-12D-1 (BK)/(WH) TEL	✓	✓	✓	✓	—
DTL-12BT-1 (BK) TEL	✓	✓	✓	✓	—
DTL-12PA-1 (BK) TEL	✓	✓	✓	✓	—
DTL-24D-1 (BK)/(WH) TEL	✓	✓	✓	✓	—
DTL-32D-1 (BK)/(WH) TEL	✓	✓	✓	✓	—
<b>IP Terminals: DT700</b>					
ITL-2E-1 (BK) TEL	—	—	—	✓	—
ITL-6DE-1 (BK) TEL	—	—	—	✓	—
ITL-8LDE-1 (BK) TEL	—	—	—	—	—
ITL-8LD-1 (BK)/(WH) TEL	✓	✓	✓	✓	—
ITL-12D-1 (BK)/(WH) TEL	✓	✓	✓	✓	—
ITL-12CG-3 (BK) TEL	✓	✓	✓	✓	—
ITL-12DG-3 (BK) TEL	✓	✓	✓	✓	—
ITL-12PA-1 (BK) TEL	✓	✓	✓	✓	—
ITL-24D-1 (BK)/(WH) TEL	✓	✓	✓	✓	—
ITL-32D-1 (BK)/(WH) TEL	✓	✓	✓	✓	—
ITL-320C-1 (BK) TEL	✓	✓	✓	✓	✓

— = Option Not Available

✓ = Optional Available

➡ The BS (Braille)-L (BK) KIT kit consists of stickers to be installed.



Table 2-128 Terminal and Ten Key Kit Compatibility (DT400/DT800)

Terminal	Ten Key Kit				
	BS(F)-Z	BS(S)-Z	BS(ACD)-Z	Sticker-Braille-Z KIT	BS (Retro-F)-Z
<b>Digital Terminals: DT400</b>					
DTZ-2E-3 (BK) TEL	—	—	—	—	✓
DTZ-6DE-3 (BK) TEL	—	—	—	—	✓
DTZ-12D-3 (BK)/(WH) TEL	✓	✓	✓	✓	✓
DTZ-24D-3 (BK)/(WH) TEL	✓	✓	✓	✓	✓
DTZ-8LD-3 (BK)/(WH) TEL	✓	✓	✓	✓	✓
<b>IP Terminals: DT800</b>					
ITY-6D-1 (BK) TEL	—	—	—	—	—
ITY-8LDX-1 (BK) TEL	—	—	—	—	—
ITZ-8LD-3 (BK) TEL	✓	✓	✓	✓	✓
ITZ-12D-3 (BK)/(WH) TEL	✓	✓	✓	✓	✓
ITZ-24D-3 (BK)/(WH) TEL	✓	✓	✓	✓	✓
ITZ-12CG-3 (BK)/(WH) TEL	✓	✓	✓	✓	✓
ITZ-12DG-3 (BK)/(WH) TEL	✓	✓	✓	✓	✓
ITZ-8LDG-3 (BK)/(WH) TEL	✓	✓	✓	✓	✓

— = Option Not Available

✓ = Optional Available

➡ The Sticker-Braille-Z kit consists of stickers to be installed.

- Table 2-129 Adapter Compatibility shows the compatibility between the adapters used in the system.

Table 2-129 Adapter Compatibility

Adapter	Adapter						
	ADA-L	APR-L	ILPA	PSA-L	BCH-L	BHA-L	GBA-L
ADA-L		—	✓	✓	—	—	✓
APR-L	—		—	✓	—	—	—

Table 2-129 Adapter Compatibility (Continued)

Adapter	Adapter						
	ADA-L	APR-L	ILPA	PSA-L	BCH-L	BHA-L	GBA-L
ILPA	✓	—		✓	—	—	✓
PSA-L	—	—	✓		—	✓	✓
BCH-L	✓	—	—	—		—	—
BHA-L	—	—	—	✓	—		—
GBA-L	✓	—	—	✓	—	—	

— = Option Not Available

✓ = Optional Available

### Encryption

- Encryption must be turned on in the DT700/DT800 as well as the SV9100 for encryption to take place.
- Encryption is supported between the DT700/DT800 terminal and the GPZ-IPLE (VoIPDB).
- Encryption can be enabled on a per phone basis.
- CCISoIP and SIP trunking are not supported.
- Program 10-26-02 RTP forwarding is not supported with encryption.
- Multicast (paging, room monitor, etc.) is not encrypted.
- If Program 90-45-01 is used to change the temporary password, all terminals using encryption will be logged off. Terminals will then need the 1-time password to be reentered.
- Encryption is not supported on DT700/DT800 series phones that are connected via NAPT.
- Encryption is not supported on DT700/DT800 series phones that are registered to a secondary NetLink system.
- DT700/DT800 series phones that are registered to a primary NetLink can fail over to a secondary system regardless of encryption settings.

### Default Settings

None

## System Availability

### Terminals

None

### Required Component(s)

None

## Related Features

None

## Ten Key Backlit Control

### Description

With Version 4000 or higher software, the brightness of the Ten Key Backlit of a multiline terminal can be adjusted to Normal (full brightness) or Half (half brightness).

#### Conditions

- If the Ten Key Backlit is ON, brightness of Ten Key Backlit is updated immediately when the system data is changed.
- If the Ten Key Backlit is OFF and system data is changed, brightness of Ten Key Backlit is updated after pressing any key.
- Brightness of backlit does not change on terminals where backlit is not supported.
- Brightness of Ten Key Backlit can also be set from UserPro.

#### Default Settings

Brightness of Ten Key Backlit is Full (Normal).

### System Availability

#### Terminals

DT400 Multiline Terminal

DT800 Multiline Terminal

#### Required Component(s)

None

### Related Features

None

## Guide to Feature Programming

The **Level 1**, **Level 2** and **Level 3** columns indicate the programs that are assigned when programming this feature in the order they are most commonly used. These levels are used with PCPro and WebPro wizards for feature programming.

- Level 1 – these are the most commonly assigned programs for this feature.
- Level 2 – these are the next most commonly assigned programs for this feature.
- Level 3 – these programs are not often assigned and require an expert level working knowledge of the system to be properly assigned.

◇ *The items highlighted in gray are read only and cannot be changed.*

### Encryption:

Program Number	Program Name/Description	Input Data	Default	Level		
				1	2	3
10-46-07	<b>DT800/DT700 Server Information Setup – Encryption Mode</b> Set encryption for signaling (requires system reset).	0 = Off 1 = On	0		✓	
10-46-08	<b>DT800/DT700 Server Information Setup – Encryption Type</b> Read Only	0 = Mode 1	0		✓	
10-46-09	<b>DT800/DT700 Server Information Setup – One Time Password</b> Set the one-time password for encryption authentication to the DT700.	Maximum of 10 characters (0~9, *, #)	No Setting		✓	
15-25-01	<b>DESI-less Page Setup – Incoming Call Notify Event</b> Enable/Disable the ability of a DESI-Less terminal to blink the page number that has an incoming call on one of the keys.	0 = Disable 1 = Enable	1		✓	
15-25-02	<b>DESI-less Page Setup – Incoming Call Automatic Screen Switching</b> Enable/Disable the ability of a DESI-Less terminal to switch to the page that has an incoming call on one of the keys.	0 = Disable 1 = Enable	1		✓	
15-25-03	<b>DESI-less Page Setup – Idle Automatic Screen Switching</b> Define or Disable the page to be automatically displayed when a DESI-Less terminal becomes idle.	0 = Disable 1 = Display page 1 2 = Display page 2 3 = Display page 3 4 = Display page 4	0		✓	
15-25-04	<b>DESI-less Page Setup – Answer Automatic Screen Switching</b> Define or Disable the page to be automatically displayed when a DESI-Less terminal answers a call.	0 = Disable 1 = Display page 1 2 = Display page 2 3 = Display page 3 4 = Display page 4	0		✓	

Program Number	Program Name/Description	Input Data	Default	Level		
				1	2	3
84-23-08	<b>DT800/DT700 Multiline Basic Information Setup – Digest Authorization Registration Expire Timer</b> Set the time for authentication update.	0 ~ 4294967295 seconds	0		✓	
84-23-09	<b>DT800/DT700 Multiline Basic Information Setup – Temporary Password</b> Read Only				✓	
84-27-03	<b>IPL Basic Setup – SRTP Mode Setup</b> Set the encryption of the SRTP (voice packets).	0 = Disable 1 = Enable	0		✓	
90-45-01	<b>Temporary Password Change for Multiline Telephone – Temporary Password Change Request</b> Change the temporary password.	00.00.00.00 ~ FF.FF.F.FF Change? (Yes :1)	00.00.00.00		✓	

**Ten Key Backlit:**

Program Number	Program Name/Description	Input Data	Default	Level		
				1	2	3
15-02-74	<b>Multiline Telephone Basic Data Setup – Ten Key Backlit Control</b> This program sets the brightness of Ten Key Backlit. When set to Normal (0), brightness of Ten Key Backlit is Full. When set to Half (1), brightness of Ten Key Backlit is Half.	0 = Normal 1 = Half	0	✓		
90-38-38	<b>User Programming Data Level Setup – Ten Key Backlit Control</b> Enable/Disable the Ten Key control setting in UserPro	0 = Off 1 = On	1		✓	

**Operation**

Refer to individual features.

**Ten Key Backlit**

**To change the brightness of the Ten Key Backlit when Backlit is ON:**

- Change the system data.
  - ◇ If Program 15-02-74 is set to 0 (Normal), brightness of the Ten Key Backlit is Full.

◇ *If Program 15-02-74 is set to 1 (Half), brightness of the Ten Key Backlit is Half.*

**To change the brightness of the Ten Key Backlit when Backlit is OFF:**

1. Change the system data.
2. Press any key to update the brightness of the Ten Key Backlit.
  - ◇ *If Program 15-02-74 is set to 0 (Normal), brightness of the Ten Key Backlit is Full.*
  - ◇ *If Program 15-02-74 is set to 1 (Half), brightness of the Ten Key Backlit is Half.*

## SV9100 UC Suite

### Description

The SV9100 UC Suite allows users to control their SV9100 terminal from their PC (Deskset mode) or the PC can become their SV9100 terminal (Softphone - IP Soft Phone Mode).

Through licensing control and user selection, the application can be tailored to meet the needs of a variety of end users. Additional utilities are provided as part of the UC Suite:

- ❑ Answering Center – with UC Suite, the Answering Center supports additional features to be utilized with the UC Client to provide efficient call handling in a multi-tenant environment. For example, if a receptionist is required to answer calls for a variety of different businesses, the Answering Center module will identify the company being called and display information on the receptionist's screen to assist with handling the call.



*CRM Integration license (license code 5310 in Program 10-50-01) and SV9100 system software Version 1000 or higher is required for Answering Center.*

- ❑ Outlook integration – allows the user to dial out, end call, conference, transfer and perform screen pops through the Contacts folder within Microsoft Outlook. Prior to UC Suite 4.5, a separate installation of the Outlook Add-In is included to provide Outlook functionality with the Web Client. This eliminates the need for a client license as the new Outlook Add-In can be configured to point to the UC Server for call control.

Outlook integration includes the ability to associate a Presence State with an Outlook Calendar Appointment, and to add telephone numbers from an Outlook Contact to the UC Client Speed Dial list. With UC Suite Version 4.5 or higher, Outlook integration is provided with the InConnect application.

With UC Suite 4.0 or higher, Outlook Calendar integration is enhanced to allow a default Presence state or Presence Profile to be automatically associated with each new Outlook calendar event created. The ability to copy the text for the event into the Remarks field of the presence details can be enabled or disabled as well.

- ❑ Salesforce.com integration – with UC Suite, Salesforce.com provides access to the following operations through the Salesforce.com interface:
  - Call contact phone number
  - Dial phone number directly
  - Answer incoming call
  - End active call
  - Hold active call
  - Retrieve a Held call
  - Transfer active call
  - Pop contact on incoming call that matches phone number.



The Salesforce.com integration module requires a Salesforce.com Professional, Enterprise, or Unlimited Edition account. The integration module is compatible with the following browsers: Internet Explorer® 11 or higher, Firefox® 15 or higher and Google Chrome™ browser Version 21 or higher.



*CRM Integration license (license code 5310 in Program 10-50-01) and SV9100 system software Version 1000 are required for Salesforce.com integration.*

- ❑ Telephony Service Provider (TSP) – with UC Suite, the 1st Party TSP installed with Desktop supports additional functionality such as transfer, conference, hold and unhold.
- ❑ Video Test Tool – Helps verify that the Softphone can communicate with and utilize the video camera connected to the PC.
- ❑ Integration Toolkit – The UC Suite has the ability to support integration with a variety of popular third-party CRM applications. These integrations typically allow the third-party software to dial numbers stored within the application and screen pop entries based upon Caller ID recognition. However, many companies use CRMs (Customer Resource Management) packages that are industry-specific or, in some cases, internally developed.

In order to provide another means to integrate with third-party applications, the Integration Developer’s Toolkit allows users to develop their own interface to the UC Suite.



*CRM Integration license (license code 5310 in Program 10-50-01) and SV9100 system software Version 1000 are required for the Integration Toolkit.*

**UC Client**

The UC Client enhances the operation of the NEC digital telephone set by providing easy access to common, and not so common, UNIVERGE SV9100 voice control features. This software application provides a very intuitive user interface that can be conveniently located at the top or bottom of the PC screen. The user interface can even "shrink" into the edge of the screen and become visible when a call arrives, or when the user moves the mouse to the edge of the display.

In addition to quick access to these SV9100 features, the UC Client provides a call log for easy viewing of recent received, missed, or made calls – just like your cell phone. It also includes a directory to keep your commonly dialed numbers close at hand, and optional features like voice recording, personal greeting, and screen pops using Microsoft Outlook, ACT! 2005 or higher, Goldmine 6.7 or higher, Salesforce.com, Time Matters and Tigerpaw®. With UC Suite, Browser-based CRM applications can screen pop a record.



*CRM Integration license (license code 5310 in Program 10-50-01) and SV9100 system software Version 1000 are required for Salesforce.com Time Matters, Tigerpaw, Answer Center integration and Browser-based CRM integration.*

UC Suite users that are also Contact Center agents can perform Contact Center functions from within the UC Client. Contact Center functions included in the UC Client are Login, Logout, Off Duty, Wrap Up, view Agent Monitor, and view Queue Monitor.

UC Client has the following main components:

- SV9100 UC Client Software**

This application runs on a PC and provides the PC-based GUI (Graphical User Interface) and features.
- Headset (Optional)**

The headset can be plugged into the multiline telephone and used when making or receiving calls with the UC Client. UC Client runs on a PC and communicates with the UNIVERGE SV9100 through TCP/IP. The UC Client can be run for a physical deskset station or a Softphone station. When calls come into the station, the UC Client displays it on the PC, and provides several features that allow the user to handle the call quickly. UC Client can be minimized to run in the background and pop to the front when call activity occurs. Calls can then be handled using either the keyboard or the mouse. The user speaks to the caller through the telephone handset, headset, or speakerphone of the multiline telephone the application is running on, or through a USB headset or headset connected to PC running the Softphone.
- Color Scheme Selection**

Users can customize the color scheme of the application. This scheme applies to the main window and the instant message window. Any sub windows (i.e., Preferences or Call Control dialog boxes) will continue to follow the Windows theme coloring.

### Multi-Device Group Support

With UC Suite version 3.5, the Full UC Client, Web Client and UT880 client support managing the numbers in a users Multi-Device group. From the UC Suite Multi-Device group window, users can change the internal and external numbers in their Multi-Device group. SV9100 R4 License is required for Multi-Device Group support.

### Contact Center Agent Functionality

UC Suite users that are Contact Center Agents can perform Contact Center functions from the UC Client GUI. Also, Contact Center Agents can perform Contact Center functions from the UC Web Client (UC Suite 4.0 or higher required). Agents can change Contact Center states (Login, Logout, Wrap Up and Off Duty), view real-time queue statistics, monitor Contact Center states for other agents and initiate Emergency Call functions from the UC Client.

UC Suite users that are Contact Center Agents can receive alerts when callers hang up while waiting in a Contact Center queue. An Abandon Call Alert icon will flash with the number of abandoned calls that are currently included in the Abandon Call List. If the user has selected the options, a notification message will appear in the system tray when a new Abandoned Call has been added to the list.

The Abandoned Call Window lists shows each abandoned call on a separate line with the most recent call at the bottom of the list. Each abandoned call includes Date, Arrival Time, Contact Center Group, Caller ID, Wait Time and Callback Status. Calls are removed from the list when the Clear Calls After time expires, is manually removed using the Delete option or a subsequent call from the same Caller ID is received in the same queue. Entries with a Callback Status of In Progress, Attempted or Complete will include additional details regarding the callback activity. The Abandoned Call Window also has the following options under File Menu: Save the list to a file, Print the list or Exit to close the Window.

## Softphone

The Softphone is a software phone that functions as an IP Multiline Station (SIP). The Softphone provides access to all features of a physical IP Multiline Station with a few exceptions. Through the VoIP connection to the SV9100 system, the user can speak to the caller through a USB Handset or USB Headset connected to the PC running the Softphone. The user can handle the call through a Toolbar view, Compact Phone view, or an Emulation Phone view that looks like a physical IP Multiline Station.

Audio frame (Payload) size for the Softphone supports only 20ms or 40ms according to CODEC type.

- G.711: PRG 84-24-01 setting must be 20ms or 40ms.
- G.729: PRG 84-24-07 setting must be 20ms or 40ms.
- G.722: PRG 84-24-32 setting must be 20ms.

Successful operation of the Softphone requires audio properties be set to a supported format. Default settings for the audio device must be set within the following range of values:

- Sampling frequency (Hz) – 8000 / 16000 / 32000 / 48000
- Quantization bit – 16 bit
- Channel – all values supported

Some USB Headsets do not support this range and are not supported in UC Client.

## SV9100 InMail Integration

UC Suite can integrate to the SV9100 InMail providing the following features:

- Message Status
  - View new messages
  - View archived messages
- Message Access
  - Play new/archived messages through the deskset terminal or Softphone
  - Set new message status to archive
  - Delete a message
  - Dial the number associated with the message



*InMail Integration license (license code 5312 in Program 10-50-01) and SV9100 system software Version 1000 are required for InMail Integration. A DT InMail integration license is needed for each Desktop user requiring InMail integration.*

InMail Integration can be set to **On** in Program 20-59-18 and on the **Voicemail Tab** in Preferences.

Users can change their InMail Greeting when changing presence states.



*When using InMail integration, all clients must connect to the UC Server or all clients must be used without connecting to the UC Server. A mixture of some clients connected and some not connected to UC Server is not supported when using InMail Integration.*

## SV9100 UM8000 Integration

UC Suite can integrate to the SV9100 UM8000 providing the following features:

- Message Status
  - Number of new messages
  - View new messages
  - View archived messages
  - View opened messages
  - View urgent messages
- Message Access
  - Play New, Urgent, Opened and Archived messages through PC audio device
  - Set new message status to archive
  - Delete a message
  - Return call
- Presence Voice Mail Greetings
 

Assign a Voice Meeting Greeting to:

  - A presence change
  - A scheduled presence change
  - An Outlook appointment presence change



- Users must have a mailbox in the voicemail system and have UM8000 integration configured in order to change the Voicemail Greeting for other users.*
- UM8000 support requires UM8000 Version 11.6 or higher and one UMS Client license (License code 1404) per Desktop user requiring UM8000 integration.*

## Mobile Client

The UC Suite Mobile Client is available with UC Suite 4.5 or higher. The UC Suite Mobile Client is a native application for tablets and smart phones that interact with the UC Suite server providing an efficient and responsive interface for mobile users. Mobile users have the ability to:

- Create personal and shared buddy lists that provide Presence status and BLF status.
- Make calls and view Call History.



*Making calls will use the cellular service and do not interact with the MLC.*

- Send and receive chat messages from other full, web, or mobile clients.
- View Company and Personal Contacts. The mobile client will blend a list of UC Suite contacts and contacts from the mobile device.

The UC Suite Mobile Client is supported on the following devices:

- Android 4.4.2 or higher for Android Tablet.

- iOS 9 or higher for iPad2 or later, or iPhone 5 or later.

**Web Client**

Users can launch a UC Client from within an Internet browser window. This Web Client provides many of the features that are available within the full UC Client. With UC Suite 4.0 and higher, Web Client adds support for Contact Center Agent functions, Directed Call Pickup, default Handset/Headset setting, Paging, Park Zone monitoring, Night Mode Switching and Voice Mail Quick Access. Refer to the UC Suite Manual for a comparison of features available between the full client and the Web Client.

With UC Suite 4.1, Web Client supports video calls with other UC Web Clients. A maximum of four parties can participate in a UC Suite Video Conference. Users can pause and restart video streaming and mute or unmute the audio.

The UC Web Client is supported on the following Internet browsers:

- Internet Explorer 11
- Firefox 24
- Google Chrome 30
- Safari® 5.0.6



- *Each UC Web Client requires a UC Web Client license.*
- *With UC Server on the InServer Blade, the Web Client is supported on the iPad.*
- *UC Web Client does not support the Internet browser Edge (Windows 10).*

**InConnect**

With UC Suite Version 4.5 or higher, InConnect is a Windows-based application that supplements the functionality of the Web Client. It is used to communicate directly to the UC Suite server to support the following features:

- CRM Integration
- Outlook Integration
- TAPI Dial
- Highlight Dial
- Activity Monitor

The InConnect application can be run as a stand-alone UC Client or in conjunction with the UC Web Client.

**UT880 UC Client**

Users can launch a UC Client from within the Multiline Telephone application (NMLT) on the UT880 terminal. This browser-based client provides many of the features that are available within the Web Client. Refer to the UC Suite Manual for a comparison of features available between the full UC Client, Web Client, and UT880 UC Client.

The UT880 UC Client is a part of the Multiline Telephone application (NMLT) version 1.0. UC Server version 1.5.0.0 or higher is required to support the UT880 UC Client.

## UC Server

The SV9100 UC Suite includes the option to install UC Server. This is required for the following features:

- SystemWide BLF/DSS
- Central Directory
- Phone Message
- Quick Message
- Presence

The InServer in-skin blade is designed to be an application server for several of the external applications available for the SV9100 product line. Initially, the InServer will come pre-installed with Windows Embedded Standard 7 OS and will support the setup and deployment of the NEC UC Suite and Contact Center. NEC UC Server and Contact Center run on the InServer blade. With the InServer blade, installation is made easier by allowing the technician to direct users to a URL where software files with preconfigured settings that automatically populate the configuration fields within the desktop can be downloaded. For more information on the InServer blade, refer to the UNIVERGE SV9100 InServer Configuration Guide.

The UC Server manages shared resources and provides communication facilities between user endpoints. The functionality implemented by the UC Server includes the following:

- Access to Operator or Receptionist Type Functions – An operator or receptionist type user can easily manage their call handling tasks without having to switch attention between the telephone and the PC. One or two clicks of the mouse is all it takes for the operator or receptionist to transfer a call or put a caller into a users voice mailbox. A company directory, recording ability, PC-to-PC messaging, and Presence indication provide additional features to further enhance the operation. The UC Client connected to the UC Server can monitor all line keys and control the actions of the operator's phone, including placing calls.

The application on the PC communicates with the SV9100 system through a TCP port on the telephone system. The UC Suite connected to UC Server also includes a supporting application called Quick Message. By installing the Quick Message client on individual PCs, the operator can quickly send short messages to other employees, who can respond with a single keystroke. The PC to be used requires an interface to the SV9100 system through the Ethernet link to monitor and control telephone activity.

- Shared Directory/Contact List – provides a shared database that includes the company directory, external contact list and personal contact list that can be accessed by all users. Without UC Server, each UC Client user must maintain their own Directory and Contact list. The external and personal contact list can be imported via a .csv file.
- Centralized BLF Monitoring – the UC Server monitors the status of all stations on the system and provides updates to the individual clients. With UC Server, the BLF status area can expand to a larger button size and provide call details when mousing over a BLF. The user can Drag and Drop BLFs in a custom order if they prefer something other than extension or name order.
- Common Trunk Labeling – provides a central storage for assigning labels to trunks.

- ❑ Quick Messaging – manages delivery of messages and responses from attendant level users to end users.

Phone Messaging – manages the delivery of messages and responses from attendant level users to end user desksets.



*With UC Suite, Phone and Quick Messages can be sent to multiple recipients.*

- ❑ Presence – indicates Availability Status, Location, Expected Return Date and Time, Forward Settings, and Special Instructions. Presence status is viewable through the Directory or the Window view DSS/BLF pane. Presence status is manually set by each UC Suite user, or users with appropriate permissions can update the Presence settings for other users. The toolbar and window views support the Presence feature.

With UC Suite, Presence states can be customized for each site. The system administrator can determine which Presence states are valid, change the icon for the pre-defined Presence states, and define up to four custom presence states with custom labels/names and custom icons.

Also, scheduling of Presence state changes is supported by a list of Presence Events each user defines in the new user interface or through the Outlook Calendar. Users also have the ability to view and set Presence status and call forwarding rules while they are out of the office. This can be achieved through mobile devices that support web browsing and desktop web browsers like Internet Explorer.

With UC Suite the Presence area is located on the title bar area. The Presence indicator in the BLF section shows animation when a users presence state changes.

With UC Suite 4.0 or higher, Smart Presence will update a user's Presence or availability based upon pre-defined rules and the detection of phone and PC activities. UC Client users can enable the client to set their status to inactive after a defined number of minutes of inactivity. The inactive user's BLF will indicate to other users how long they have been inactive. When keyboard or mouse activity is detected, or when the user has an active call on their extension, the status will be changed back to active. Users can also enable the client to prompt them for a presence state change when the application is opened or closed. UC Web client users will have an application close option allowing them to set a presence state when the web client is closed.

Also, with UC Suite 4.0 or higher, the Presence Profiles feature allows each UC Web Client user to create a shortcut for frequently used presence settings. Users can Add, Edit, and Delete Presence Profiles. When a Presence Profile is selected, the presence state and associated settings will be applied.

- ❑ Mobility – with UC Suite, mobile users can view and set presence status and call forwarding options while way from the office.



***MOBILE PRESENCE (License Code 5311) and SV9100 system software Version 1000 or higher is required for Mobility features.***

- ❑ Profile Sharing – UC Server allows users to create and share profiles consisting of commonly used preferences and configurations.

All settings in the following **Preferences** tabs are saved in the Profile:

- General



- BLF/DSS
- Tool Buttons
- Active Call List
- Screen Pop
- Shortcuts
- Dialing Rules
- Telephony Settings
- Voice Mail
- Notification Settings
- Quick Message
- Phone Message
- Trunk Settings
- Phone Image

Only selected settings in the following Preferences tabs are saved in the profile:

- Recording (Record All Calls, Enable beep tone while recording)
- Agent (Network Name/IP Address, Port Number)

The following General User Interface Settings are saved in the profile:

- UI Mode (Window, Toolbar, or Compact Phone)
- Sort BLF By (Extension, Name, or Drag and Drop)
- Size and position of main window in Window Mode

Users configured to connect to the UC Server can apply a saved profile from the Tools menu in Window mode or the File menu in Toolbar mode.

- Park – With UC Server, UC Clients can monitor all 64 park orbits in the SV9100. A Park area at the bottom of the Window view shows the current status of the park orbits. The user can configure which park orbits are of interest to them and UC Client will only show these orbits. Each monitored park orbit will indicate when it is in use and hovering the mouse over this icon will display a pop-up box that shows the name/extension of the person parking the call, the CLID of the parked call if available, and the length of time that the call has been parked. While on an active call, the users can click one of the unoccupied orbits and park the call with one mouse click.

The Park Area can also be configured to include a Valet button which will use the Step Park function to park the call in the next available park orbit. The Valet option is also available from right clicking an active call.

Also, while on an active call, users can Drag and Drop the call to an available park orbit or the Valet button to park the call in the next available orbit.

- Instant Messenger – With UC Server, UC Client users can instant message each other. A maximum of eight IM sessions can be established with different users. UC Suite has the ability to maintain a history of the Instant Message sessions for each user. Previous IM sessions with a particular user can be recalled to the History area at any time. When the user scrolls to the first message in a session, a button is displayed in the History area allowing the user to load the previous IM session.



- ❑ Profile View – Users can upload or capture a profile picture to be associated with their entry in the Directory. An additional BLF view with larger BLF buttons can be selected to display Profile Pictures instead of the Presence state images. The Profile Picture will also be displayed in the Instant Message Window.

**Licensing**

The following table lists and describes the UC Suite related part numbers and licenses:

*Table 2-130 Desktop Suite Licenses*

Item Name	Description
SV9100 STANDARD USER-LIC 01	Allows for a UC Client or a Web Client, Outlook Add-in, a UC Server connection for Presence, Central Directory, Instant Messaging and UCS Voicemail integration (InMail or UM8000), and single column BLF panel. Enables license codes (5305) UCS Client, (5309) UCS Advanced Service, (5312) UCS Voicemail Integration, (5313) UCS Web Client, (0012) 3rd Party CTI.
SV9100 UC ADVANCE USER-LIC 01	(5326) Allows everything the Standard does, but adds Multi-Tab (Full Client)/ Multi Buddy List BLF (Web Client), Park Monitor, Video Call and Mobile Client support.
SV9100 PREMIUM USER- LIC 01	Allows everything the Standard User does but adds CRM Integration and Attendant level features like BLF Tabs, Phone Message, ability to change other users Presence States, Park Orbit Monitoring, detailed phone status monitoring, Wide column BLF panel, Pinning, Mobile Client and Video. Enables license codes (5304) UCS Attendant Client and (5310) UCS CRM Integration.
SV9100 SOFTPHONE CLIENT- LIC 01	Allows for a softphone client, enables license 5301 UCS Softphone Client. Allows collaboration with DataConference (Video, Chat, Communication Board, and document sharing). Enables license code 5303 UCS Softphone Enhanced.

**Feature Mapping**

The following table shows the features associated with each of the user levels with the addition of the Advanced User license available in UC Suite v4.1 or higher.

*Table 2-131 Feature Mapping*

Feature Name/Description	Standard	Advanced	Premium	ala carte
Standard Telephony Features	✓	✓	✓	
Single BLF View	✓	✓	✓	
Presence and Presence Profiles	✓	✓	✓	
Standard Outlook Addin	✓	✓	✓	
Headset Mode	✓	✓	✓	
Chat/Messaging	✓	✓	✓	

Table 2-131 Feature Mapping (Continued)

Feature Name/Description	Standard	Advanced	Premium	ala carte
Call History	✓	✓	✓	
Contacts Database	✓	✓	✓	
Multi Column View in BLF	✓	✓	✓	
Enhanced Outlook Addin	✓	✓	✓	
UC Inactivity timer	✓	✓	✓	
Multi Tab/Buddy List BLF		✓	✓	
Park Monitor		✓	✓	
Video Call (WebRTC)		✓	✓	
Directory Edit			✓	
Night Mode			✓	
Phone Messaging			✓	
BLF POP Based on DNIS			✓	
Contact Center Integration			✓	✓
CRM License			✓	✓

### Multiple Logon

The same user name and password can be assigned to multiple extensions when using Automatic or Manual Registration. This makes it easier on the user by only having to remember one password. For example, if a user has an IP Multiline terminal and uses UC Suite with the Enhancement bundle controlling the IP Multiline, three different ports are used in the system. All three can be assigned the same user name and password.

### TCP/UDP Port and Windows Process Firewall Exceptions

When a firewall is involved in the network between the SV9100 and the UC Client or UC Server. Refer to [Table 2-132 Exceptions to Firewall for Ports](#) for exceptions to be made in the firewall for ports and [Table 2-133 Exceptions to Windows Process](#) on page 2-1575 for windows processes.

Table 2-132 Exceptions to Firewall for Ports

UC Suite Component	TCP and/or UDP	Port Numbers	Related Program
SIP	UDP	5070~5197	

Table 2-132 Exceptions to Firewall for Ports (Continued)

UC Suite Component	TCP and/or UDP	Port Numbers	Related Program
Audio RTP	UDP	60000~60254	
Video Control	TCP	6000	
Video RTP	UDP	61000~61019	
File Transfer	TCP	8282~8284	
License	TCP	6080	
DataConference Control	TCP	62010~32019	
DataConference Video	UDP	62010~32019	
Outlook Integration/Highlight Dial/CallToTag/XML API	TCP	20864~20865	
TSP Support: UDP/TCP 972-973	UDP and TCP	972~973	
UC Server Client Connection	TCP	8888	
Instant Message	TCP	8888	
3rd Party Call Control	TCP	8181	10-20-1 Device 1 – CTI Server
1st Party Call Control	TCP	8282	10-20-1 Device 9 – 1st Party CTI
File and Print Sharing	UDP and TCP	137	
Operation & Maintenance (O&M)	UDP and TCP	8010	
Web Client	UDP and TCP	8080	Version 3.0 and lower uses port 8080. Version 3.5 and higher uses port 80 unless defined otherwise during installation.

Table 2-133 Exceptions to Windows Process

Windows Process Firewall Exceptions
NECPhone.exe
RPCTIService.exe
DataMeeting.exe
RtcSvGM.exe

## Virtual Machine Support

With the increasing popularity of deploying virtual machine environments by IT organizations, UC Server supports the virtual machine environments listed below. This option provides a cost-effective alternative to implementing a physical server.

Applications: UC Server R1 or higher

Guest OS: Windows 7 Pro (64-bit)

Windows 10 Pro (64-bit)

Hypervisor: #1 VMWare ESXi 5.5/6

#2 Hyper-V 5.0 (Hyper-V 5.0 is included in Windows Server 2012 R2 (64-bit))

## SLT Support

With UC Suite 4.1 and higher, Single Line Telephones (SLT) and 3rd Party SIP stations are supported as desktop clients with a limited feature set. The following is a list of supported SLT functions:

- Dial\*
- Transfer
- Conference
- Hold
- End Call
- Forward
- DND
- Redirect

\* This function will generate a call to the target device and require the user to manually go off hook for the operation to be initiated.

## Video Support

With UC Suite 4.1 and higher, users can enable the video features within the Web Client. A user can send a request to start a video call from the Buddy List or from an active call. A video call can also be initiated from an active call. When an audio call is promoted to a video call, the WebRTC audio is muted and the phone audio becomes active. If desired, participants may choose to end the voice call and unmute the WebRTC audio.

Video features are available to standard users with advanced features (License Code 5326) or to premium users.

Controls within the video frame allow the user to perform the following functions:

- Pause sending video
- Hide self video image
- Resize video images
- Mute audio

- ❑ End video call

Add user to video call (maximum of four participants)

### Conditions

- When migrating from the SV8100 UC Desktop, all SV8100 UC Desktop software must be uninstalled before installing the SV9100 UC Suite. This includes Shared Services, NEC Telephony Driver, UC Desktop Client and RP Web Admin if on an InServer blade. Refer to the SV9100 UC Suite Manual for further information on the removal process.
- Migrating an InServer blade from SV8100 UC Desktop to SV9100 UC Suite requires the SV9100 InServer Migration kit.
- UC Suite does not support the Cordless DTL-8R-1 terminal.
- The UC Client must be running in order to run the Answering Center.
- The UC Suite does not support Centrex trunks for transferring or call forwarding off-site.
- The UC Suite does not follow delay ringing. For example, if a virtual extension is set to delay ring and appears on a UC Suite terminal, the UC Client will show the call as ringing immediately.
- The Bluetooth Cordless Handset (BCH) is not a supported terminal when using 1st-Party CTI, 3rd-Party CTI, or with the UC Suite.
- Up to 512 UC clients are supported with UC Server. Clients without a UC Server connection and Softphone clients are still limited to a maximum of 256 connections. Any 1st-Party CTI Driver connections take away from the 256 maximum connections.
- A separate Outlook Add-In installation to support Outlook functionality with Web Client and to support Outlook functionality without a client.
- The SV9100 UC Suite does not support Network Address Translation (NAT). Because of this, any UC Client must appear to be on the same network as the SV9100 VoIP Interface (GPZ-IPLE). For remote UC Clients, like Softphone, this can be achieved by a VPN connection to the network the SV9100 resides on.
- The UC Suite requires an ADA-L Adapter installed on the multiline terminal with connection directly to the client PC for Call Recording and Personal Greeting voice functions when running in deskset mode.
- The GCD-CP10 must be licensed for either an IP Terminal license when using a Softphone or the Enhancement Bundle.
- UC Suite users can dial digits while a call is in progress.
- When UC Suite is in Toolbar mode, if the docked edge is changed from Top to Bottom or Bottom to Top, it may rearrange the icons on the PC Desktop.
- Recording with Softphone mode does not require an ADA adapter. Recording is done through the softphone.
- The Voice Mail button on the tool bar is not used in the US market.

- If the dial window is open when a new call rings into the Desktop, and the phone is on-hook, the new call takes priority and the dial window will close.
- When using the Chat feature in the UC Suite, the maximum number of characters in a chat message is 256.
- The integration between the desktop application and the GCD-CP10 does not support CAP keys 4000-9999. Only 0001-3999 can be supported. CAP keys above 3999 can be used elsewhere in the system, but not for CTI controlled extensions which include UC Suite.
- To reset the Telephony Settings (i.e., Service Codes) to default, you must delete the c:\Documents and Settings\All Users\Application Data\Cygnus Application Suite\PC Phone\TapiConfig.xml file and it recreates with defaults on the next launch of the application.
- Using an ADA-L for recording in Deskset mode for the UC Suite: DIPS 1 and 6 on the ADA-L should be on with all others off.
- Any station using UC Suite, in softphone or deskset mode, must have an ICM key programmed in 15-07 (\*00).
- If DND is set for another station, the BLF shows Red. If Call Forward Immediate (CFA) is set for another station, the BLF shows Blue
- For UC Clients without a UC Server Connection, BLF/DSS to be monitored in the UC Client must be programmed on a physical key on the phone or DSS console attached to the phone. DSS/BLF buttons that are programmed on buttons that do not physically exist on the phone or on a DSS console that is not physically present do not show up in the UC Client.
- When using a Softphone, buttons 25-40 are not supported. The Softphone only supports keys 1-24.
- Without UC Server, ringing trunk calls show green. With the Shared Services solution, ringing trunks calls show red.
- When running UC Client in deskset mode for an IP phone when the registration mode is set to automatic or manual, the user name and password must be different than that of the IP phone.
- A Softphone that is assigned a DSS console cannot override another IP phone.
- A Softphone cannot override an IP phone that is assigned a DSS console.
- Once a Softphone with a DSS console is logged in, it cannot log in with a different user name and password.
- Once a UC Client is launched on one PC using a User ID and Password in deskset or Softphone mode, the same User ID and Password cannot be used on a different PC in a different mode.
- If the desktop is launched for a phone that is on a call, the desktop will not show the active call until it is placed on hold.

- The Enhancement Bundle features require a non-Deskset only license level even when controlling a Deskset phone. When a non-Deskset only license level is selected, the UC Client registers as an IP station consuming an additional system port.
- The system sees terminal types 1 (Economy), 2 (Value), 3 (Desi-Less), 4 (Sophisticated) and 5 (Softphone) as the same terminal type.
- When using Multiple Logon, the same Personal ID index can be assigned to an ITL/Softphone, and a CTI (UC Client) terminal type.
- Two ports of the same terminal type (Program 15-05-26) cannot be assigned to the same Personal ID index (Program 15-05-27).
- Program 10-46-01 must be set to 1 (Auto) or 2 (Manual) for Multiple Logon to work.
- When three ports are assigned the same Personal ID index in Program 15-05-27, if Program 15-05-26 is not set for those ports, the terminal types will be assigned based on order of login. If Program 15-05-26 is set, the login order does not matter and they will assign the correct port.
- The Override feature functions the same as single login.
- When using manual registration for IP stations in Program 10-46-01, the UC Suite User ID and Password in Programs 20-59-01 and 20-59-02 must match the Softphone User ID and Password in Programs 84-22-01 and 84-22-02
- When selecting the Deskset license level in Program 20-59-14 with UC Server connect enabled in Program 20-14-13, call control is handled by the Telephony Service Provider on the UC Server.
- The new Voice Message notification by Windows Toast is only supported in Softphone mode, and not in Desktop mode.
- The new Voice Message notification by Windows Toast is only supported with InMail. The UM8000 Mail does not support this Voice Message notification in UC Desktop Applications.
- The Synchronization button within **Preferences** is available to the license levels in Program 20-59-14 shown below as long as UC Server is not used:
  - Softphone
  - Softphone + Deskset
- The Synchronization button within **Preferences** is *not* available to the Deskset license level in Program 20-59-14 with or without UC Server.
- InMail Integration is not supported in a Centralized VM environment over IP or T1 CCIS.
- When using a CS50 USB Headset for Softphone audio device, the Disable CS50 Power Saving option should be checked in the Desktop Configuration Wizard. This disables the CS50's power save/sleep mode which is not supported by UC Suite. Please note that this will decrease the CS50's battery time.
- NAT or NAPT is only supported on the DT700 series phones. NAT or NAPT is not supported on the ML440, the Wireless DECT (SIP) or Softphone.

- If analog Caller ID trunks are being used, Program 14-02-23 must be set to **Wait Caller ID** for Salesforce to receive the caller ID for screen pops.
- With CO lines, if TAPI is present in the system, there is a designed delay in ringing the station so TAPI can capture the CID.
- When using InMail integration, all clients must use UC Server or all clients must be used without UC Server. A mixture of some clients with UC Server and some without is not supported when using InMail Integration.
- If an Outlook appointment is set for less than 30 minutes and you open the Presence Form, the duration is changed to 30 minutes.
- Using up or down arrows in the Presence State fields in Web Client is not supported.
- ACT! 2001, 2012 and 2013 are supported with the following conditions:
  - In Act>Tools>Preferences>Communications>Dialer Preferences choose **NEC Single Line Device as modem or line** and uncheck Hide dialer after dialing.
  - Windows Phone and Modem properties need to be configured for local dialing.
  - With ACT! 2012 and 2013, use either the “Hang up” button in the ACT! dialer window to disconnect the call or toggle the handset if you hang up the phone and close the ACT! dialer window. Failure to do either would hold the dialer open in ACT!
  - With ACT! 2013, a reboot is required after configuring the integration.
- The Outlook Add-in is supported with the following Outlook versions (32- and 64-bit):
  - Outlook 2003
  - Outlook 2007
  - Outlook 2010
  - Outlook 2013
- Recurring Appointments in Outlook will not set recurring Presence changes in UC Client. Only the initial change will occur.
- DID name information of analogue trunk type will not be sent by TSP.
- When a station in a Multi-Device group is busy, only the BLF for the active station will show busy, not all stations in the Multi-Device Group.
- If internal extensions or mobile extensions are added to the Multi-Device Group via system programming using Program 20-63 the UC Client must be restarted to reflect these changes.
- The number of external numbers available in the Multi-Device group is directly related to the number of Mobile Extensions defined in the group (Program 20-63). If the user requires additional external numbers, more mobile extensions need to also be added to the group using Program 20-63. The UC Suite must be restarted for these changes to take effect.
- When a UC Client is configured with the Softphone+Deskset license level in Program 20-59-14, the UC Client will always use the Deskset extension to search for a matching Multi-Device Pilot.



- If DND or CFA is set for the Pilot or any member of the Multi-Device Group, only the station that is set will show DND or CFA in the UC Suite BLF view, not each member in the group.
- When disabling all numbers in a Multi-Device Group using UC Suite, the MDG key programmed on the pilot extension will stay lit. The MDG key on member extensions will go out until the group is enabled again.
- UC Client, v.3.0 or earlier is incompatible with the SV9100 R4 CPU. Use of these UC Client versions may limit access to some UC features.
- UC Client, v.3.5 will not be fully compatible with the SV9100 R3 CPU or earlier. In particular, the CRM integration features within the UC Client will not be enabled.
- With Version 5000 or higher, Caller ID for VE Others Answer (OTH ANS) is saved when UC suite is in Softphone mode.
- With UC Suite Version 4.0 or higher, attendant-level users have the ability to assign DID numbers to a BLF group or tab. When assigned, an incoming call can trigger the UC Client to automatically display the BLF tab that matches the inbound DID.
- Real time audio bandwidth per session is approximately 100 kbit/sec. The video bandwidth per session is approximately 500 kbit/sec. For example, in a 2 person video call, 4 RTP ports are needed and the minimum audio would be 200 kbit/sec (2\*100) and video 1 Mbit/sec (2\*500). The total bandwidth per user would then be 1.2 Mbit/sec.
- For UT880 sites with the UC Web Server set for HTTPS in UC Services Configuration, the UC Server must have a SSL security certificate installed. Refer to the **SSL Certificate Installation on the UC Server Blade** chapter in the SV9100 UC Suite Manual.
- UC Suite Mobile Client must be on the same local network as the UC Suite server or connected to the network via VPN.

## Default Settings

None

## System Availability

### Terminals

- All ITL/DTL type terminals
- All ITZ/DTZ type terminals
- SLT and 3rd Party SIP stations with a limited feature set

### Required Component(s)

- Processor Speed: 2Ghz
- RAM: 4GB

- Display: Super VGA (800x600) or higher
- 40GB Available Disk Space
- CD ROM Drive
- Network Adapter
- Sound Card
- ADA-L for Recording/Personal Greeting in deskset mode
- The desktop system supports the following operation systems:

**Server:**

- Windows 7 Professional (32-bit and 64-bit)
- Windows Server 2008 (32-bit and 64-bit)
- Windows Server 2012, Windows Server 2012 R2
  - ◇ *Prior to installing SV9100 UC Advanced Services, Microsoft .NET 3.5 must be enabled. Follow the link below for instructions.*  
<https://technet.microsoft.com/en-us/library/dn482071.aspx>
  - ◇ *Install SV9100 UC Advanced Services after enabling .NET 3.5 features as described in the technical note.*
- Windows 8 Professional and Enterprise (32-bit and 64-bit)
- Windows 8.1 Professional and Enterprise (32 bit and 64 bit)
  - ◇ *Refer to the Conditions section for Windows 7 32-bit and 64-bit limitations.*
  - ◇ *Microsoft .NET Framework 3.5 must be enabled for Windows 8 and Server 2012.*
- Windows 10 Professional and Enterprise (32-bit and 64-bit)

**Client:**

- Windows 7 Professional (32-bit and 64-bit)
- Windows 8 Professional and Enterprise (32-bit and 64-bit)
- Windows 8.1 Professional and Enterprise (32-bit and 64-bit)
- Windows 10 Professional and Enterprise (32-bit and 64-bit)

**Optional Component(s)**

- Video Camera
- Microphone/Headset/USB Handset
- Speakers

## Related Features



Refer to the *UNIVERGE SV9100 UC Suite Manual* for detailed feature information.

## Guide to Feature Programming

The **Level 1**, **Level 2** and **Level 2** columns indicate the programs that are assigned when programming this feature in the order they are most commonly used. These levels are used with PCPro and WebPro wizards for feature programming.

- Level 1 – these are the most commonly assigned programs for this feature.
- Level 2 – these are the next most commonly assigned programs for this feature.
- Level 3 – these programs are not often assigned and require an expert level working knowledge of the system to be properly assigned.

◇ *The items highlighted in gray are read only and cannot be changed.*



*In addition to the following programming, define the programming options as required for the system features.*



*Refer to the UNIVERGE SV9100 Programming Manual for programming details. Callback, Callback Request, and Auto Redial are not supported.*

Program Number	Program Name/Description	Input Data	Default	Level		
				1	2	3
<b>10-12-03</b>	<b>GCD-CP10 Network Setup – Default Gateway</b> Define the default gateway to be used by the GPZ-IPLE interface.	0.0.0.0 ~ 126.255.255.254 128.0.0.1 ~ 191.255.255.254 192.0.0.1 ~ 223.255.255.254	0.0.0.0	✓		
<b>10-12-09</b>	<b>GCD-CP10 Network Setup – IP Address</b> Set IP address for GPZ-IPLE.	0.0.0.0 ~ 126.255.255.254 128.0.0.1 ~ 191.255.255.254 192.0.0.1 ~ 223.255.255.25	172.16.0.10	✓		

Program Number	Program Name/Description	Input Data	Default	Level		
				1	2	3
10-12-10	<b>GCD-CP10 Network Setup – Subnet Mask</b> Define the Media Gateway Subnet Mask Address.	128.0.0.0   192.0.0.0   224.0.0.0  240.0.0.0   248.0.0.0   252.0.0.0  254.0.0.0   255.0.0.0  255.128.0.0   255.192.0.0  255.224.0.0   255.240.0.0  255.248.0.0   255.252.0.0  255.254.0.0   255.255.0.0  255.255.128.0   255.255.192.0  255.255.224.0   255.255.240.0  255.255.248.0   255.255.252.0  255.255.254.0   255.255.255.0  255.255.255.128  255.255.255.192  255.255.255.224  255.255.255.240  255.255.255.248  255.255.255.252  255.255.255.254  255.255.255.255	255.255.0.0		✓	
10-20-01	<b>LAN Setup for External Equipment – TCP Port</b> Define the TCP port number for the LAN CTI and O&M communication between the GCD-CP10 and the UC Suite.	0 ~ 65535	External Device 1 (CTI Server) = 0 External Device 2 (Contact Center) = 4000 External Device 5 (SMDR Output) = 0 External Device 6 (DIM Output) = 0 External Device 9 (1st Party CTI) = 0 External Device 11 (O&M Server) = 8010 External Device 12 (Traffic Report Output) = 0 External Device 13 (Room Data Output for Hotel Service ) = 0	✓		

Program Number	Program Name/Description	Input Data	Default	Level		
				1	2	3
10-46-01	<p><b>DT700 Series Server Information Setup – Register Mode</b></p> <p>If set to 0, when the phone boots up it reports the ext. assigned in the phone or chooses the next available extension in the system. No password is required.</p> <p>If set 1 the SIP user name and password must be entered on the actual IP phone. These settings must match 84-22/15-05-27, or the phone does not come on-line.</p> <p>If set to 2, when the phone boots up it prompts user to enter a user ID and password before logging in. It checks this user ID/password against 84-22/15-05-27. If there is no match, the phone does not come on-line.</p>	<p>0 = Normal</p> <p>1 = Auto</p> <p>2 = Manual</p>	0		✓	
10-69-01	<p><b>UC Server General Settings – UC Server Availability</b></p> <p>Enable the UC Server if it is to be used.</p>	<p>0 = Disable</p> <p>1 = Enable</p>	0	✓		
10-69-02	<p><b>UC Server General Settings – UC Server IP Address</b></p> <p>Define the IP address of the UC Server.</p>	<p>0.0.0.0 ~ 126.255.255.254</p> <p>128.0.0.1 ~ 191.254.255.254</p> <p>192.0.0.1 ~ 223.255.255.254</p>	0.0.0.0	✓		
10-69-03	<p><b>UC Server General Settings – UC Server Host Name</b></p> <p>Define the host name of the UC Server.</p>	Any characters	No Setting		✓	
10-69-04	<p><b>UC Server General Settings – UC Server Port Number</b></p> <p>Define the port UC Clients will connect to the UC Server on. Recommended port 8888.</p>	0 ~ 65535	0	✓		
10-69-05	<p><b>UC Server General Settings – UC Server Trace</b></p> <p>Enable if NTAC requests to turn on. This is used for troubleshooting purposes only.</p>	<p>0 = Disable</p> <p>1 = Enable</p>	0		✓	
10-69-06	<p><b>UC Server General Settings – UC Server Use Name for Communication</b></p> <p>Enable if the clients will communicate with the UC Server via host name (not IP).</p>	<p>0 = Disable</p> <p>1 = Enable</p>	0		✓	
10-69-07	<p><b>UC Server General Settings – UC Server Large System Mode</b></p> <p>Enable if the system is to support more than 256 stations.</p>	<p>0 = Disable</p> <p>1 = Enable</p>	0		✓	
10-69-08	<p><b>UC Server General Settings – UC Server Auto Restart</b></p> <p>Enable if the UC Server is required to be reset periodically for cleanup purposes.</p>	<p>0 = Disable</p> <p>1 = Enable</p>	0		✓	
10-69-09	<p><b>UC Server General Settings – UC Server Auto Restart Frequency</b></p> <p>If Auto Restart is enabled, specify if Weekly or Monthly.</p>	<p>0 = Weekly</p> <p>1 = Monthly</p>	0		✓	

Program Number	Program Name/Description	Input Data	Default	Level		
				1	2	3
10-69-10	<b>UC Server General Settings – UC Server Auto Restart : Day of the Week</b> If Auto Restart is set for Weekly, specify which day of the week it will occur.	0: Sunday 1: Monday 2: Tuesday 3: Wednesday 4: Thursday 5: Friday 6: Saturday	0		✓	
10-69-11	<b>UC Server General Settings – UC Server Auto Restart Week</b> If Auto Restart is set for Monthly, specify which week in the month it will occur.	0 = First 1 = Second 2 = Third 3 = Fourth	0		✓	
10-69-12	<b>UC Server General Settings – UC Server Auto Restart Day</b> If Auto Restart is set for Monthly, specify which day of the week set in Program 10-69-11 it will occur.	0: Sunday 1: Monday 2: Tuesday 3: Wednesday 4: Thursday 5: Friday 6: Saturday	0		✓	
10-69-13	<b>UC Server General Settings – UC Server Auto Restart Time</b> Specify the time of day the Auto Restart will occur. This applies to Monthly or Weekly.	00:00 ~ 23:59	00:00		✓	
10-70-01	<b>UC Server Voicemail Interface Settings – UC Server Voicemail Integration</b> Enable if the UC Suite will have Voicemail Integration.	0 = Disable 1 = Enable	0	✓		
10-70-02	<b>UC Server Voicemail Interface Settings – UM8000 IP Address</b> If the voicemail system is UM8000, specify the IP address of the UM8000.	0.0.0.0 ~ 126.255.255.254 128.0.0.1 ~ 191.254.255.254 192.0.0.1 ~ 223.255.255.254	0.0.0.0	✓		
10-70-03	<b>UC Server Voicemail Interface Settings – UM8000 Port Number</b> If the voicemail system is UM8000, specify the port number UC Suite will connect to the UM8000 on. ➡ <i>This should be set to port 1024.</i>	0 ~ 65535	0	✓		
10-71-01	<b>UC Server MIS Settings – MIS Server IP Address</b> If the UC Server will integrate to the Contact Center Server for Abandoned Call Alerts, define the IP address of the Contact Center Server.	0.0.0.0 ~ 126.255.255.254 128.0.0.1 ~ 191.254.255.254 192.0.0.1 ~ 223.255.255.254	0.0.0.0		✓	
10-71-02	<b>UC Server MIS Settings – MIS Server Computer Name</b> If the UC Server will integrate to the Contact Center Server for Abandoned Call Alerts, define the Contact Center Server's computer name.	Any characters	No Setting		✓	

Program Number	Program Name/Description	Input Data	Default	Level		
				1	2	3
10-71-03	<p><b>UC Server MIS Settings – MIS Server Port Number</b></p> <p>If the UC Server will integrate to the Contact Center Server for Abandoned Call Alerts, define the port number it should connect on.</p> <p>➤ <i>The Contact Center Server TCP/IP Port in Server Settings should be set to the value (port) in 10-71-03. In most cases 9090 is a suitable port.</i></p>	0 ~ 65535	0		✓	
13-04-01	<p><b>Speed Dialing Number and Name – Speed Dialing Data</b></p> <p>Enter the System and Group Speed Dialing numbers and names.</p> <p>➤ <i>External numbers defined in the Multi-Device group show up in the bin referenced in Program 15-22 for the mobile extension.</i></p>	<p>Maximum of 24 digits (0 ~ 9, *, #, @, P, R)</p> <p>@ = Wait for Answer Supervision - ISDN trunks only</p> <p>P = Pause - Analog Trunk Only</p> <p>R = Hook flash - Analog Trunk Only</p>	No Setting		✓	
15-05-27	<p><b>IP Telephone Terminal Basic Data Setup – Personal ID Index</b></p> <p>When the SIP Multiline telephone is using manual/auto registration, assign each phone a unique personal index. Then go to command 84-22 to assign the user name and password.</p>	0 ~ 960	0		✓	
15-05-28	<p><b>IP Telephone Terminal Basic Data Setup – Addition Information Setup</b></p> <p>Set Talking Party to 0 for Desktop Application softphone.</p>	<p>0 = Do not inform</p> <p>1 = Inform</p>	0		✓	
15-07-01	<p><b>Programmable Function Keys</b></p> <p>Assign a function key to terminals.</p>	<p>Line Key 1 ~ 48</p> <p>0 ~ 99 (Normal Function Code 751 by default)</p> <p>*00 ~ *99 (Appearance Function Code) (Service Code 752 by default)</p>	Refer to the Programming Manual for default values.		✓	
15-22-01	<p><b>Mobile Extension Setup – Mobile Extension Target Setup</b></p> <p>For each Mobile Extension number defined in the Multi-Device Group (Program 20-63), select the Speed Dial bin number to be associated with it.</p>	<p>0 ~ 9999</p> <p>(0 = No setting</p> <p>1 ~ 9999 = target of mobile extension)</p>	0		✓	
20-23-06	<p><b>System Options for CTI – 3rd Party CTI IP Address</b></p> <p>Read only program that displays the IP address of the currently connected 3rd Party CTI Server.</p>	<p>0.0.0.0 ~ 126.255.255.254</p> <p>128.0.0.1 ~ 191.255.255.254</p> <p>192.0.0.1 ~ 223.255.255.254</p>	0.0.0.0.0		✓	
20-57-41	<p><b>UC User Information Settings – Extension Number</b></p> <p>Define extension settings in UC Suite.</p>	Dial (maximum of eight digits)	No Setting			
20-58-01	<p><b>UC Server Presence Settings – UC Server Presence States: In the Office</b></p> <p>Enable or Disable the In the Office Presence State for UC Suite.</p>	<p>0 = Disable</p> <p>1 = Enable</p>	0	✓		

Program Number	Program Name/Description	Input Data	Default	Level		
				1	2	3
20-58-02	<b>UC Server Presence Settings – UC Server Presence States: On Vacation</b> Enable or Disable the On Vacation Presence State for UC Suite.	0 = Disable 1 = Enable	0	✓		
20-58-03	<b>UC Server Presence Settings – UC Server Presence States: Business Travel</b> Enable or Disable the Business Travel Presence State for UC Suite.	0 = Disable 1 = Enable	0	✓		
20-58-04	<b>UC Server Presence Settings – UC Server Presence States: In a Meeting</b> Enable or Disable the In a Meeting Presence State for UC Suite.	0 = Disable 1 = Enable	0	✓		
20-58-05	<b>UC Server Presence Settings – UC Server Presence States: Out to Lunch</b> Enable or Disable the Out to Lunch Presence State for UC Suite.	0 = Disable 1 = Enable	0	✓		
20-58-06	<b>UC Server Presence Settings – UC Server Presence States: Sick</b> Enable or Disable the Sick Presence State for UC Suite.	0 = Disable 1 = Enable	0	✓		
20-58-07	<b>UC Server Presence Settings – UC Server Presence States: Gone for the Day</b> Enable or Disable the Gone for the Day Presence State for UC Suite.	0 = Disable 1 = Enable	0	✓		
20-58-08	<b>UC Server Presence Settings – UC Server Presence States: Out of the Office</b> Enable or Disable the Out of the Office Presence State for UC Suite.	0 = Disable 1 = Enable	0	✓		
20-58-09	<b>UC Server Presence Settings – UC Server Presence States: Unavailable</b> Enable or Disable the Unavailable Presence State for UC Suite.	0 = Disable 1 = Enable	0	✓		
20-58-10	<b>UC Server Presence Settings – UC Server Presence States: Unknown</b> Enable or Disable the Unknown Presence State for UC Suite.	0 = Disable 1 = Enable	0	✓		
20-58-11	<b>UC Server Presence Settings – UC Server Custom Presence Usage</b> Enable or Disable the use of the Custom Presence States for UC Suite.	0 = Disable 1 = Enable	0		✓	
20-58-12	<b>UC Server Presence Settings – UC Server Custom Presence 1 Definition</b> Define the name of Custom Presence State number 1.	Any characters	No Setting		✓	



Program Number	Program Name/Description	Input Data	Default	Level		
				1	2	3
20-58-13	<b>UC Server Presence Settings – UC Server Custom Presence 1 Use</b> Enable or Disable number 1 custom Presence State for UC Suite.	0 = Disable 1 = Enable	0		✓	
20-58-14	<b>UC Server Presence Settings – UC Server Custom Presence 2 Definition</b> Define the name of Custom Presence State number 2.	Any characters	No Setting		✓	
20-58-15	<b>UC Server Presence Settings – UC Server Custom Presence 2 Use</b> Enable or Disable number 2 custom Presence State for UC Suite.	0 = Disable 1 = Enable	0		✓	
20-58-16	<b>UC Server Presence Settings – UC Server Custom Presence 3 Definition</b> Define the name of Custom Presence State number 3.	Any characters	No Setting		✓	
20-58-17	<b>UC Server Presence Settings – UC Server Custom Presence 3 Use</b> Enable or Disable number 3 custom Presence State for UC Suite.	0 = Disable 1 = Enable	0		✓	
20-58-18	<b>UC Server Presence Settings – UC Server Custom Presence 4 Definition</b> Define the name of Custom Presence State number 4.	Any characters	No Setting		✓	
20-58-19	<b>UC Server Presence Settings – UC Server Custom Presence 4 Use</b> Enable or Disable number 4 custom Presence State for UC Suite.	0 = Disable 1 = Enable	0		✓	
20-59-01	<b>UC Server Settings – UC User ID</b> Define the user ID for the UC Suite User	Any character	No Setting	✓		
20-59-02	<b>UC Server Settings – UC User Password</b> Define the password for the UC Suite User.	Any character	No Setting	✓		
20-59-03	<b>UC Server Settings – UC - DT Client</b> Enable or Disable the users ability to launch a UC full PC client.	0 = Disable 1 = Enable	0	✓		
20-59-04	<b>UC Server Settings – UC - DT Web Client</b> Enable or Disable the users ability to launch a Web Client.	0 = Disable 1 = Enable	0	✓		
20-59-05	<b>UC Server Settings – UC - Deskset Extension</b> If the UC Suite User will control a Deskset extension, define the extension number to control.	0 ~ 9, *, #	No Setting	✓		

Program Number	Program Name/Description	Input Data	Default	Level		
				1	2	3
20-59-06	<b>UC Server Settings – UC - Softphone Extension</b> If the UC Suite User will use a softphone, define the extension number.	0 ~ 9, *, #	No Setting	✓		
20-59-07	<b>UC Server Settings – UC - IM- Allow</b> If the UC Suite User will be allowed to send and receive Instant Messages.	0 = Disable 1 = Enable	0	✓		
20-59-08	<b>UC Server Settings – UC - Shared Data Allow</b> Enable if the UC Suite User will be allowed to edit the Directory.	0 = Disable 1 = Enable	0	✓		
20-59-09	<b>UC Server Settings – UC - Global Presence Change Allow</b> Enable if the UC Suite User will be allowed to change other users presence states.	0 = Disable 1 = Enable	0	✓		
20-59-10	<b>UC Server Settings – UC - Message Feature Allow</b> Enable if the UC Suite User will be allowed to send and receive Phone Messages.	0 = Disable 1 = Enable	0	✓		
20-59-11	<b>UC Server Settings – UC - Phone Monitor Allow</b> Enable if the UC Suite User will be allowed to view the current call state of other extensions.	0 = Disable 1 = Enable	0	✓		
20-59-12	<b>UC Server Settings – UC - Block to be Monitored</b> Enable if the UC Suite User's call state should be blocked from being viewed by other UC Suite users with Program 20-59-11 enabled.	0 = Disable 1 = Enable	0	✓		
20-59-13	<b>UC Server Settings – UC - Server Connect</b> Enable if the UC Suite User's client will connect to the UC Server.	0 = Disable 1 = Enable	0	✓		
20-59-14	<b>UC Server Settings – UC - License Level</b> Define if the UC Suite User will use a Deskset, Softphone, or Deskset + Softphone. (Deskset + Softphone is needed for UC Suite users controlling a deskset but require data conference.	0 = Softphone 1 = Deskset 2 = Softphone + Deskset	0	✓		
20-59-15	<b>UC Server Settings – UC - Login Mode</b> Define if the UC Suite User will control a Deskset or be a Softphone.	0 = Softphone 1 = Deskset	0	✓		
20-59-16	<b>UC Server Settings – UC - Attendant Mode</b> Enable or Disable if the UC Suite User will have full Attendant type functionality like BLF Tabs, Phone Message, ability to change other users Presence States, Park Orbit Monitoring, detailed phone status monitoring, Pinning and Wide Column BLF.	0 = Disable 1 = Enable	0		✓	

Program Number	Program Name/Description	Input Data	Default	Level		
				1	2	3
20-59-17	<b>UC Server Settings – UC - Trial Mode</b> Enable or Disable if the client will come up in trial mode. Once this is set, the first time the client logs in the trial will be active on that PC for 30 days.	0 = Disable 1 = Enable	0		✓	
20-59-18	<b>UC Server Settings – UC - Voicemail Interface</b> Enable if the UC Suite user will have Voicemail integration.	0 = Disable 1 = Enable	0	✓		
20-59-19	<b>UC Server Settings – UC - Agent Mode</b> Enable if the UC Suite user will use Contact Center integration.	0 = Disable 1 = Enable	0		✓	
20-59-20	<b>UC Server Settings – UC - Abandon Callback</b> Enable if the UC Suite user will use the Abandoned Call Alert Feature.	0 = Disable 1 = Enable	0		✓	
20-59-21	<b>UC Server Settings – UC - CRM Integration</b> Enable if the UC Suite user will use CRM Integration.	0 = Disable 1 = Enable	0		✓	
20-60-01	<b>UC Server Telephony Settings – UC Server Consult Call for Immediate Transfer</b> Enable if Immediate transfers off-site are not working.	0 = Disable 1 = Enable	0		✓	
20-60-02	<b>UC Server Telephony Settings – UC Server Emergency Number</b> Define the number dialed for emergency calls.	0 ~ 9, *, #	No Setting	✓		
20-61-01	<b>UC Server Call Alerts Feature Settings – UC Server Abandon Call Alerts</b> Enable the Abandoned Call Alert feature.	0 = Disable 1 = Enable	0		✓	
20-61-02	<b>UC Server Call Alerts Feature Settings – UC Server Minimum Wait Time</b> Define the minimum wait time for the call to be included in the abandoned call alert list.	00:00 ~ 23:59	00:00		✓	
20-61-03	<b>UC Server Call Alerts Feature Settings – UC Server Clear Call Timer</b> Define the time limit for calls to remain on the Abandoned Calls Alert list. When a call has been on the list for longer than the specified time, the call is automatically removed from the list. If this field is blank, calls are not removed automatically and will stay on the list until manually deleted.	00:00 ~ 23:59	00:00		✓	
20-61-04	<b>UC Server Call Alerts Feature Settings – UC Server Clear Call If Matching Caller ID Returns to Queue</b> Define if a call will be removed from the Abandoned Calls list if a subsequent call returns to the queue with the same Caller ID.	0 = Disable 1 = Enable	0		✓	

Program Number	Program Name/Description	Input Data	Default	Level		
				1	2	3
20-62-01	<b>UC Exception Table – Dial Data</b> Define dial strings that are not internal calls but are the same digit length as internal station numbers.	0 ~ 9, *, #	No Setting		✓	
20-63-01	<b>Multi-Device Group Setup – Pilot Extension Number</b> Used to assign the pilot group extension number.	Maximum of eight digits (Group 1 ~ 256)	No Setting		✓	
20-63-02	<b>Multi-Device Group Setup – Member Extension Number 1</b> Used to assign the first extension number in the call group.	Maximum of eight digits (Group 1 ~ 256)	No Setting		✓	
20-63-03	<b>Multi-Device Group Setup – Member Extension Number 2</b> Used to assign the second extension number in the call group.	Maximum of eight digits (Group 1 ~ 256)	No Setting		✓	
20-63-04	<b>Multi-Device Group Setup – Member Extension Number 3</b> Used to assign the third extension number in the call group.	Maximum of eight digits (Group 1 ~ 256)	No Setting		✓	
20-63-05	<b>Multi-Device Group Setup – Member Extension Number 4</b> Used to assign the fourth extension number in the call group.	Maximum of eight digits (Group 1 ~ 256)	No Setting		✓	
20-63-06	<b>Multi-Device Group Setup – Member Extension Number 5</b> Used to assign the fifth extension number in the call group.	Maximum of eight digits (Group 1 ~ 256)	No Setting		✓	
20-63-07	<b>Multi-Device Group Setup – Member Extension Number 6</b> Used to assign the sixth extension number in the call group.	Maximum of eight digits (Group 1 ~ 256)	No Setting		✓	
20-63-08	<b>Multi-Device Group Setup – Member Extension Number 7</b> Used to assign the seventh extension number in the call group.	Maximum of eight digits (Group 1 ~ 256)	No Setting		✓	
30-01-01	<b>DSS Console Operating Mode</b> Set the DSS system Console mode.	0 = Business Mode 1 = Hotel Mode 2 = Monitor Mode 3 = Business/ Mode	0		✓	
30-02-01	<b>DSS Console Extension Assignment – Extension Number</b> Set the extension number for the multiline terminal connected with the DSS console (up to eight digits).	Maximum of eight digits.	No Setting	✓		

Program Number	Program Name/Description	Input Data	Default	Level		
				1	2	3
30-03-01	<b>DSS Console Key Assignment</b> For DSS Console Chaining, assign an Speed Dialing Service Code (or) plus a 2-digit bin number to a DSS Console key.	Key Number 001 ~ 114 0 ~ 99 (General Functional Level) 97 = Door Box Access key (additional data: 1 ~ 8 Door Box No.) * 00 ~ * 99 (Appearance Functional Level)	Refer to the Programming Manual for default values.		✓	
84-20-02	<b>SIP Extension Basic Information Setup – Session Timer Value</b> Define the periodic refresh time that allows both user agents and proxies to determine if the SIP session is still active.	0 ~ 65535 seconds	180		✓	
84-20-03	<b>SIP Extension Basic Information Setup – Minimum Session Timer Value</b> Define to convey the minimum allowed value for the SIP session timer.	0 ~ 65535 seconds	180		✓	
84-22-01	<b>DT800/DT700 Series Multiline Logon Information Setup – User ID</b> Input the User ID for each Personal ID Index (1-960) when using auto or manual registration in 10-46-01.	Maximum of 32 characters.	No Setting		✓	
84-22-02	<b>DT800/DT700 Series Multiline Logon Information Setup – Password</b> Input the Password for each Personal ID Index (1-960) when using auto or manual registration in 10-46-01.	Maximum of 16 characters.	No Setting		✓	
84-26-01	<b>IPL Basic Setup – IP Address</b> Assign the IP address for the DSP on the GPZ-IPLE.	xxx.xxx.xxx.xxx	Slot 1 = 172.16.0.20		✓	

## Operation



Refer to the *UNIVERGE SV9100 UC Desktop Suite Applications Manual* for detailed feature information.

# Synchronous Ringing

## Description

Synchronous Ringing synchronizes CO/PBX incoming ringing with the incoming ringing pattern from a Central Office.

### Conditions

- When the multiline terminal is ringing at Secondary Extension (SE)/Virtual Extension (VE) key, Synchronous Ring works.
- Synchronous Ringing is not supported for Tie/DID incoming calls, Off-Hook Ringing, or CO/PBX Ring Transfers.
- If Synchronous Ringing is enabled, the VRS Preamble Message cannot be used.

### Default Settings

Enabled

## System Availability

### Terminals

All Terminals except Single Line Telephones connected to AP(R)-R or APR-U Unit

### Required Component(s)

None

## Related Features

None

## Guide to Feature Programming

The **Level 1**, **Level 2** and **Level 3** columns indicate the programs that are assigned when programming this feature in the order they are most commonly used. These levels are used with PCPro and WebPro wizards for feature programming.

- Level 1 – these are the most commonly assigned programs for this feature.
- Level 2 – these are the next most commonly assigned programs for this feature.
- Level 3 – these programs are not often assigned and require an expert level working knowledge of the system to be properly assigned.

Program Number	Program Name/Description	Input Data	Default	Level		
				1	2	3
14-02-17	<b>Analog Trunk Data Setup – Sync. Ringing</b> Enable/Disable per trunk.	0 = Disable 1 = Enable	1	✓		
20-15-01	<b>Ring Cycle Setup – Normal Incoming Call on Trunk</b> Define the ring cycle for Normal Incoming trunk calls.	Ringing Cycle = 1 ~ 13	2		✓	
20-15-02	<b>Ring Cycle Setup – PBX, CES Incoming Call</b> Define the ring cycle for PBX and CES incoming trunk calls.	Ringing Cycle = 1 ~ 13	8		✓	
20-15-04	<b>Ring Cycle Setup – DID/DISA/VRS</b> Define the ring cycle for DID/DISA/VRS incoming calls.	Ringing Cycle = 1 ~ 13	8		✓	
20-15-05	<b>Ring Cycle Setup – DID/DDI</b> Define the ring cycle for DID/DDI incoming calls.	Ringing Cycle = 1 ~ 13	8		✓	
20-15-06	<b>Ring Cycle Setup – Dial-In in the E&amp;M Tie Line</b> Define the ring cycle for Dial IN and E&M Tie line calls.	Ringing Cycle = 1 ~ 13	12		✓	
20-15-07	<b>Ring Cycle Setup – Door Box Ringing for SLT</b> Define the ringing cycle for Door Box Ringing for SLT terminals.	Ringing Cycle = 1 ~ 13	8		✓	
20-15-08	<b>Ring Cycle Setup – Virtual Extension Ring</b> Define the ringing cycle for Virtual Extensions.	Ringing Cycle = 1 ~ 13	8		✓	
20-15-09	<b>Ring Cycle Setup – Callback</b> Define the ringing cycle for callbacks.	Ringing Cycle = 1 ~ 13	11		✓	
20-15-10	<b>Ring Cycle Setup – Alarm for SLT</b> Define the ring cycle for Alarm for SLT terminals.	Ringing Cycle = 1 ~ 13	5		✓	

Program Number	Program Name/Description	Input Data	Default	Level		
				1	2	3
20-15-11	<b>Ring Cycle Setup – VRS Waiting Message Incoming Call</b> Define the ring cycle for incoming VRS Waiting messages.	Ringing Cycle = 1 ~ 13	6		✓	
22-03-01	<b>Trunk Ring Tone Range – Ring Tone Pattern</b> Assign Ring Tone Ranges to trunks. Trunks ring extensions according to the Ring Tone Range selected in Program 22-03-0 and the settings made with either Service Code 720 or Program 15-02-02.	0 ~ 12 (Ring Tone Pattern 1 ~ 4) (Melody 1 ~ Melody 5) (Ring Tone Pattern 5 ~ 8)	0		✓	

## Operation

None



## System Caller Log

### Description

With this feature, the user can check all caller logs one by one when they push the system caller log function key. User can check 200 caller logs in the System. All outside calls whether answered or not are stored in the System Call log.

### Conditions

- The system caller log key is appearance function code. Set Program 20-07-10 to '1' in order to set key via service code.
- The latest log is shown first. The system call log is registered when a call ends. (The call log list is not the order of incoming call time.)
- The oldest log can be checked when the user presses the up soft-key or Volume UP Key.
- Only trunk Calls are displayed.(Program 15-02-34 settings are not used.)
- The Cursor key on DT7xx/DT8xx/DT3xx/DT4xx terminals can be used to control the scroll feature.
- One record in 'SYSTEM CALL HISTORY' function is registered relating to one external incoming call.
- If a notified calling number agrees in search of Common ABB (Program 13-04) area, the name of ABB is registered into the 'SYSTEM CALL HISTORY' record. Telephone Book is not applied.
- Internal Caller Logs are not displayed in this feature.
- Search and jump function are not supported.
- The Caller Logs are erased when system is reset.
- Only a user can operate the system caller log key.
- The system caller log is not supported on the DSS console function key.
- The called extension number is not displayed.
- If Program 20-02-18 times out, the LCD display changes to IDLE automatically.
- Missed calls are noted by an asterisk.

### Default Settings

Enabled

## System Availability

### Terminals

All Station and Trunk Terminals

### Required Component(s)

GCD-CP10

Table 2-134 Station Application

Terminal Type	Applied/Not Applied	Remarks
DT300 Series	Y	
DT400 Series	Y	
DT700 Series	Y	
DT800 Series	Y	
Bluetooth Handset	Y	
DC550/Softphone	Y	Console only.
Curl Cordless Telephone	Y	

Y = Applied  
N = Not Applied

Table 2-135 Trunk Application

Terminal Type	Applied/Not Applied	Remarks
Analog Line	Y	*1
ISDN (BRI) Line	Y	*1
ISDN (PRI) Line	Y	*1
SIP Line	Y	*1
H.323 Line	Y	*1
CCIS	Y	*1

Y = Applied  
N = Not Applied  
\*1 = Trunk is registered to Caller Log.

## Related Features

None

## Guide to Feature Programming

The **Level 1**, **Level 2** and **Level 3** columns indicate the programs that are assigned when programming this feature in the order they are most commonly used. These levels are used with PCPro and WebPro wizards for feature programming.

- Level 1 – these are the most commonly assigned programs for this feature.
- Level 2 – these are the next most commonly assigned programs for this feature.
- Level 3 – these programs are not often assigned and require an expert level working knowledge of the system to be properly assigned.

Program Number	Program Name/Description	Input Data	Default	Level		
				1	2	3
15-07-01	<b>Programmable Function Keys</b> Assign functions to multiline terminal line keys.	Line Key 1 ~ 48 0 ~ 99 (Normal Function Code 751 by default) *00 ~ *99 (Appearance Function Code) (Service Code 752 by default) *35 - System Call History	Refer to the Programming Manual for default values.	✓		

### Related System Data:

Program Number	Program Name/Description	Input Data	Default	Level		
				1	2	3
15-02-34	<b>Multiline Telephone Basic Data Setup – Call Register Mode</b> The Caller ID Scroll stores Trunk calls only (0), or both Internal and Trunk calls (1). ➡ For the ML440 extensions this should be set to 1.	0 = Trunk Mode 1 = Extension/Trunk Mode	0		✓	
15-07-01	<b>Programmable Function Keys</b> Assign functions to multiline terminal line keys.	Line Key 1 ~ 48 0 ~ 99 (Normal Function Code 751 by default) *00 ~ *99 (Appearance Function Code) (Service Code 752 by default) *08 - Incoming Caller ID list	Refer to the Programming Manual for default values.		✓	

## Operation

1. User pushes the System Caller Log key in idle mode.
2. User can check the all of the system caller log one by one.

Figure 2-96 System Caller Log Example 1



3. User can page by pushing up and down key.

Figure 2-97 System Caller Log Example 2

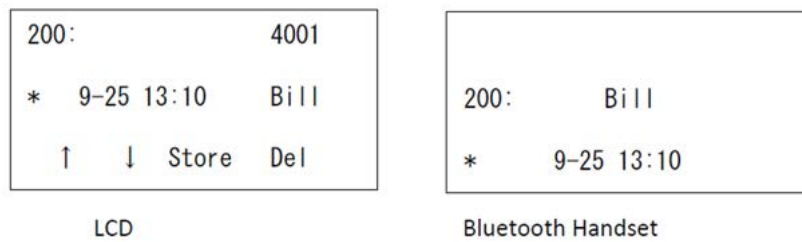

4. LED Operation:

On (Red)	Other Using
On (Green)	Using
Off	Not Using

## T1 Trunking (with ANI/DNIS Compatibility)



### Description

The T1/PRI Interface gives the system T1 trunking ability. This blade uses a single universal slot and provides up to 24 trunk circuits. In addition to providing digital-quality trunking, the T1/PRI Interface allows you to have maximum trunking ability with fewer blades. This in turn makes more universal slots available for other functions.

You can program each T1/PRI for any combination of the following trunks:

- CO loop start
- CO ground start
- Direct Inward Dialing
- Tie Lines <sup>4</sup>

GCD-PRTA uses the first block of 24 consecutive trunks. For example, if you have a GCD-4COTB with GPZ-4COTF installed for trunks 1~8, the T1/PRI Interface automatically uses trunks 9~32. If you have GCD-4COTB with GPZ-4COTF installed for trunks 1~8 and 17~24, the T1/PRI uses trunks 25~48. The T1/PRI Interface cannot use trunks 9~16 (even if available) since they are not part of a consecutive block of 24 trunks. Each T1/PRI requires that 24 consecutive ports be available in the system even if not all the ports are used otherwise the blade does not function.

The GCD-PRTA can be programmed as a 4/8/12/16/20/24 port Fractional T1/PRI.

### ANI/DNIS Compatibility

The system is compatible with Telco T1 Automatic Number Identification (ANI) and Dialed Number Information Service (DNIS) services. A compliment to Caller ID service, ANI/DNIS Compatibility provides:

- Receive Format  
The Receive Format must be set as **\*ANI\*DNIS\*** in Program 34-09-01 option 4, which is treated as a Feature Group D format. (Example of ANI Information KP009727517645STKP7100ST.)
- Flexible Routing  
Based on the data received, the system can route the incoming ANI/DNIS call to:
  - An extension
  - A or Voice Mail master extension number

---

4. Two-wire (four-lead) type 1 Tie Lines (FIC TL11M) only.

- A VRS and play a VRS message to the caller
- A Department Group pilot number
- A trunk Ring Group
- Route According to DID Translation Table or Speed Dial Bins  
Calls can be routed based on either the number of digits defined in Program 22-09-01 (digits 1~8) or by digits entered in Speed Dial bins in Program 13-04-01.

### ANI/DNIS Data Displayed as Caller ID Data

- Data Error and Unanswered Call Handling  
If a call cannot be completed, send it to a predetermined Ring Group or play supervisory tones to the caller.

### Conditions

- T1 Trunking requires a T1/PRI Interface and a customer-provided CSU/DSU to interface with the Telco. Consult your sales representative and the System Hardware Manual for additional details.
- ANI/DNIS Compatibility requires using system DTMF receivers. When all receivers are busy, the incoming ANI/DNIS call waits for a receiver to become available.
- The ANI/DNIS/Address data received from the Telco can have up to 10 digits.
- An extension Class of Service (Program 20-09-02) determines whether ANI information is displayed.
- Refer to [Digital Trunk Clocking on page 2-407](#) for the specifics on how the system detects dial tone.
- The T1 Tie Line can be used for networking.
- The T1/PRI Interface provides Tie Line service. All programming parameters are the same as those used for analog Tie Lines (except for the additional T1/PRI Interface settings).
- With an UNIVERGE SV9100 – Expanded Port Package, up to 400 T1 trunks can be assigned.
- You can use T1 trunks in place of standard analog trunks. The procedures for placing and answering calls are the same for both trunks.
- The T1/PRI Interface provides DID service. All programming parameters are the same as those used for analog DID trunks (except for the additional T1/PRI Interface settings).
- SMDR can print trunk port names or received dialed number for ANI/DNIS or DID trunks. If enabled in programming, DNIS digits can be printed on the SMDR reports instead of the trunk name.
- T1 trunks follow Tie Line toll restriction programming (Program 34-01-05 and Program 34-08).
- When using Fractional T-1s, the blade comes up with zero ports until Program 10-03-06 is set to the 4/8/12/16/20/24(auto) and then reset.

- If the number of ports are changed for a fractional T-1 in Program 10-03-06, the trunk ports could be reassigned if the numerical sequence would split or it could fit into an empty gap of trunk ports.

Examples:

The GCD-4COTB with GPZ-4COTF is assigned for trunk ports 1~8 and 17~24 and the T-1 (12 ports) was assigned as ports 25~36, the number of T-1s change to eight ports instead of 12. The new trunk port numbers are assigned as 9~16 because the eight ports can fit into the gap between ports 8 and 17 without splitting the numerical port number sequence.

The GCD-4COTB with GPZ-4COTF is assigned for trunk ports 1~8 and 17~24 and the T-1 (eight ports) was assigned as 9~16 and then the T-1 was changed from eight to 12 ports. The new trunk port numbers are assigned as 25~36 because the port number sequence would have to be split to keep them within the original number sequence (9~16) and splitting the numerical port number sequence is not supported.

- Incoming calls on T1/ANI trunks can only follow Program 22-11-01. They do not follow Programs 22-11-05 and 22-11-06.
- DID name information of T1 trunk type will not be sent by TSP.

## Default Settings

Disabled

## System Availability

### Terminals

All Terminals

### Required Component(s)

- GCD-PRTA
- Locally provided CSU/DSU

### Required Software

None

## Related Features

- ➔ [Caller ID](#)
- ➔ [Central Office Calls, Answering](#)
- ➔ [Central Office Calls, Placing](#)
- ➔ [Code Restriction](#)
- ➔ [Dial Tone Detection](#)
- ➔ [Direct Inward Dialing \(DID\)](#)
- ➔ [ISDN Compatibility](#)
- ➔ [Station Message Detail Recording](#)

## Guide to Feature Programming

The **Level 1**, **Level 2** and **Level 3** columns indicate the programs that are assigned when programming this feature in the order they are most commonly used. These levels are used with PCPro and WebPro wizards for feature programming.

- Level 1 – these are the most commonly assigned programs for this feature.
- Level 2 – these are the next most commonly assigned programs for this feature.
- Level 3 – these programs are not often assigned and require an expert level working knowledge of the system to be properly assigned.

◇ *The items highlighted in gray are read only and cannot be changed.*

Program Number	Program Name/Description	Input Data	Default	Level		
				1	2	3
10-03-01	<b>ETU Setup (DTI (T1) PKG Setup) – Logical Port Number</b> Set various T1 trunk options for compatibility with the local Telco. For ANI/DNIS, the following settings in Program 10-03 are recommended: Item 02: Frame Type = 0 (D4) Item 03: Zero Suppression = 1 (AMI/ZCS) Item 04: Distance Between ETU and CSU = 0 (0 ~ 133') Item 05: Clock Select = 1 (Internal) Item 06: DTI No. of Ports= 0 (Auto/24), 1 (4 Ports), 2 (8 Ports), 3 (12 ports), 4 (16 ports), and 5 (20 Ports)	The start port number of a T1 line is displayed, and 24 logic ports are automatically assigned to a DTI (T1) line. 0 ~ 200	0	✓		



Program Number	Program Name/Description	Input Data	Default	Level		
				1	2	3
10-03-02	<b>ETU Setup (DTI (T1) PKG Setup) – T1 Signal Format Selection</b> Set up and confirm the basic configuration data for logical port number T1.	0 = D4 (12 Multi Frame) 1 = ESF (24 Multi Frame)	1	✓		
10-03-03	<b>ETU Setup (DTI (T1) PKG Setup) – Zero Code Suppression</b> Set up and confirm the basic configuration data for the Clear Channel Selection.	0 = B8ZS 1 = AMI/ZCS	0	✓		
10-03-04	<b>ETU Setup (DTI (T1) PKG Setup) – Line Length Selection</b> Set up and confirm the basic configuration data for the Line Length Selection.	0 = 0 feet ~ 133 feet 1 = 133 feet ~ 266 feet 2 = 266 feet ~ 399 feet 3 = 399 feet ~ 533 feet 4 = 533 feet ~ 655 feet	0	✓		
10-03-05	<b>ETU Setup (DTI (T1) PKG Setup) – T1 Clock Source</b> Set up and confirm the basic configuration data for the DTI trunk type assignment.	0 = Internal 1 = External	1	✓		
10-03-06	<b>ETU Setup (DTI (T1) PKG Setup) – Number of Ports</b> Set up and confirm the basic configuration data for the number of ports required.	0 = Auto 1 = 4 Ports 2 = 8 Ports 3 = 12 Ports 4 = 16 Ports 5 = 20 Ports	0	✓		
10-09-01	<b>DTMF and Dial Tone Circuit Setup</b> For ANI/DNIS, reserve at least one DTMF receiver for DTMF reception (entry 0 or 2). Use the following as a guide when allocating DTMF receivers: In light traffic sites, allocate one DTMF receiver for every 10 devices that use them. In heavy traffic sites, allocate one DTMF receiver for every five devices that use them.	0 = Common Use 1 = Extension Only 2 = Trunk Only	Circuit/Resource 01 ~ 08 = 1 (Extensions) Circuit/Resource 09 ~ 32 = 2 (Trunks) Circuit/Resource 33 ~ 144 = 0 (Common) When GPZ-BS10 is installed, 81 ~ 144 are available		✓	
10-39-01	<b>Fractional Setup – Fractional</b> Enable/Disable T1/PRI fractional function.	0 = Disable 1 = Enable	0		✓	
14-01-02	<b>Basic Trunk Data Setup – Transmit Level</b> Select transmit level of CODEC Gain (signal amplification) for each trunk.	Trunks 1 ~ 400 1 ~ 57 (-15.5 ~ +12.5dB in 0.5dB intervals)	32 (0dB)		✓	
14-01-03	<b>Basic Trunk Data Setup – Receive Level</b> Select receive level of CODEC Gain (signal amplification) for each trunk.	Trunks 1 ~ 400 1 ~ 57 (-15.5 ~ +12.5dB in 0.5dB intervals)	32 (0dB)		✓	

Program Number	Program Name/Description	Input Data	Default	Level		
				1	2	3
14-01-07	<b>Basic Trunk Data Setup – Outgoing Calls</b> Allow/Deny outgoing calls on the trunk you are programming.	0 = Deny (No) 1 = Allow (Yes)	1		✓	
14-02-01	<b>Analog Trunk Data Setup – Signaling Type (DP/DTMF)</b> For ANI/DNIS, the following additional settings in Program 14-02 are recommended: ○ Item 1: Signaling Type (DP/DTMF) = 2 (DTMF) ○ Item 2: Ring Detect Type = 1 (Immediate) ○ Item 3: Flash Type = 0 (Open Loop Flash) ○ Item 4: Flash for Time Flash or Disconnect = 0 (Timed Flash) ○ Item 5: Dial Tone Detection for Manually Dialed Calls = 1 (Outgoing calls allowed)	0 = Dial Pulse (10 PPS) 1 = Dial Pulse (20 PPS) 2 = DTMF	2	✓		
14-02-02	<b>Analog Trunk Data Setup – Ring Detect Type</b> Set the trunks for Extended Ring Detect or Immediate Ring Detect. For T1 loop/ground start trunks, set this option to 1 for the trunks to ring and light correctly.	Trunks 1 ~ 400 0 = Normal/delayed 1 = Immediate Ringing	1		✓	
14-04-01	<b>Behind PBX Setup</b> For ANI/DNIS, Stand Alone (Trunk) setting is recommended: Behind PBX.	0 = Stand Alone (Trunk) 1 = Behind PBX (PBX) 2 = Not Used 3 = CTX Assume 9	0		✓	
14-05-01	<b>Trunk Group – Trunk Group Number</b> For ANI/DNIS, place all your ANI/DNIS trunks in Trunk Groups as required.	Trunk Port 1 ~ 400 Group Number 0 ~ 100 Priority 1 ~ 400	Default = Trunks 1 ~ 400 assigned to trunk group 1 with priorities equal to the trunk number. Trunk 1 = Priority 1 Trunk 400 = Priority 400.	✓		
20-06-01	<b>Class of Service for Extensions</b> Assign a Class of Service (1 ~ 15) to an extension.	Day Night/Mode: 1 ~ 8 Class of Service of Extensions (1 ~ 15)	Extension port 101 = Class 15 All other extension port = Class 1	✓		
20-09-01	<b>Class of Service Options (Incoming Call Service) – Second Call for DID/DISA/DIL/ E&amp;M Override</b> Turn Off or On an extension ability to receive a second call from a DID, DISA, DIL, or tie line caller. ➡ <i>With this option set to 1, the destination extension must be busy for a second DNIS caller to ring through. If the destination extension does not have a trunk or CAP key available for the second call and a previous call is ringing the extension but has not yet been answered, the second caller hears busy regardless of this program setting.</i>	0 = Off 1 = On	COS 1 ~ 15 = 1		✓	

Program Number	Program Name/Description	Input Data	Default	Level		
				1	2	3
20-09-02	<b>Class of Service Options (Incoming Call Service) – Caller ID Display</b> Turn Off or On the Caller ID display at an extension.	0 = Off 1 = On	COS 1 ~ 15 = 0	✓		
20-14-01	<b>Class of Service Options for DISA/E&amp;M – First Digit Absorbption (Delete First Digit Dialed)</b> For Tie Lines, Enable/Disable the ability to ignore the first incoming digit. Use this to make the tie trunk compatible with 3- and 4-digit Tie Line service. This option does not apply to DISA.	0 = Off 1 = On	COS 1 ~ 15 = 0		✓	
20-14-02	<b>Class of Service Options for DISA/E&amp;M – Trunk Group Routing/ARS Access</b> Enable/Disable a DISA or tie trunk caller ability to dial 9 for Trunk Group Routing or Automatic Route Selection (ARS).	0 = Off 1 = On	COS 1 ~ 15 = 1		✓	
20-14-03	<b>Class of Service Options for DISA/E&amp;M – Trunk Group Access</b> Enable/Disable a DISA or tie trunk caller ability to access trunk groups for outside calls (Service Code 704).	0 = Off 1 = On	COS 1 ~ 15 = 1		✓	
20-14-04	<b>Class of Service Options for DISA/E&amp;M – Outgoing System Speed Dial</b> Enable/Disable a DISA or tie trunk caller ability to use System Speed Dialing.	0 = Off 1 = On	COS 1 ~ 15 = 0		✓	
20-14-05	<b>Class of Service Options for DISA/E&amp;M – Operator Calling</b> Enable/Disable a DISA or tie trunk caller ability to dial 0 for the telephone system operator.	0 = Off 1 = On	COS 1 ~ 15 = 1		✓	
20-14-06	<b>Class of Service Options for DISA/E&amp;M – Internal Paging</b> Enable/Disable a DISA or tie trunk caller ability to use telephone system Internal Paging.	0 = Off 1 = On	COS 1 ~ 15 = 1		✓	
20-14-07	<b>Class of Service Options for DISA/E&amp;M – External Paging</b> Enable/Disable a DISA or tie trunk caller ability to use telephone system External Paging.	0 = Off 1 = On	COS 1 ~ 15 = 1		✓	
20-14-08	<b>Class of Service Options for DISA/E&amp;M – Direct Trunk Access</b> Enable/Disable a DISA or tie trunk caller ability to use Direct Trunk Access (Service Code 715).	0 = Off 1 = On	COS 1 ~ 15 = 0		✓	
20-14-09	<b>Class of Service Options for DISA/E&amp;M – Forced Trunk Disconnect &lt;Not for ISDN T-point&gt;</b> Enable/Disable a tie trunk caller ability to use Forced Trunk Disconnect (Service Code *26). This option is not available to DISA callers.	0 = Off 1 = On	COS 1 ~ 15 = 0		✓	

Program Number	Program Name/Description	Input Data	Default	Level		
				1	2	3
20-14-10	<b>Class of Service Options for DISA/E&amp;M – Call Forward Setting by Remote via DISA</b> Enable/Disable a DISA caller ability to use the Call Forward service codes (Program 11-11-01 through Program 11-11-05).	0 = Off 1 = On	COS 1 ~ 15 = 0		✓	
20-14-11	<b>Class of Service Options for DISA/E&amp;M – DISA/Tie Trunk Barge-In</b> Enable/Disable a DISA or tie trunk user from using the Barge-In feature.	0 = Off 1 = On	COS 1 ~ 15 = 0		✓	
20-14-12	<b>Class of Service Options for DISA/E&amp;M – Retrieve Park Hold</b> Turn Off or On the ability for a DISA caller to retrieve parked or held calls. ➤ <i>Only applies to CCIS Trunks.</i>	0 = Off 1 = On	COS 1 ~ 15 = 1		✓	
22-02-01	<b>Incoming Call Trunk Setup – Incoming Type</b> For each T1 trunk, set the Trunk Service Type to match the Telco connected T1 service. For each T1 trunk that should support ANI/DNIS service, enter 7. (ANI/DNIS trunks must be immediate start or wink start T1 trunks with E&M signaling.) For T1 loop/ground start trunks defined as 0, Program 14-02-02 must be set to 1 for the trunks to ring and light correctly.	0 = Normal 1 = VRS (second dial tone if no VRS installed) 2 = DISA 3 = DID 4 = DIL 5 = E&M Tie line 6 = Delayed VRS 7 = ANI/DNIS 8 = DID(DDI) Mode Switching	0	✓		
22-11-01	<b>DID Translation Number Conversion – Received Number</b> For each DID Translation Table entry (1 ~ 4000), specify the digits received by the system.	Maximum of eight digits.	No Setting	✓		
22-11-02	<b>DID Translation Number Conversion – Target Number</b> For each DID Translation Table entry (1 ~ 4000), specify the extension the system dials after translation.	Maximum of 24 digits.	No Setting	✓		
22-11-03	<b>DID Translation Number Conversion – DID Name</b> For each DID Translation Table entry (1 ~ 4000), specify the name that should show on the dialed extension display when it rings.	Maximum of 12 digits.	No Setting	✓		
22-13-01	<b>DID Trunk Group to Translation Table Assignment</b> Assign DID translation tables to trunk groups.	DID Translation Tables: 1 ~ 20 Trunk Groups: 1 ~ 100 0 ~ 20 (0 = No Setting)	1		✓	
34-01-01	<b>E&amp;M Tie Line Basic Setup – DID/E&amp;M Start Signaling</b> For each ANI/DNIS trunk, set the start signaling mode to 1.	0 = 2nd Dial Tone 1 = Wink (default) 2 = Immediate 3 = Delay	1		✓	

Program Number	Program Name/Description	Input Data	Default	Level		
				1	2	3
34-01-02	<p><b>E&amp;M Tie Line Basic Setup – Receive Dial Type for E&amp;M Tie Line</b></p> <p>For DID and tie trunks, set the trunk signaling type (Dial Pulse or DTMF).</p> <p>➔ Program 34-01-02 must be set to (2) = MF in order for T1 ANI to work.</p>	<p>0 = DP</p> <p>1 = DTMF</p> <p>2 = MF</p>	1	✓		
34-01-03	<p><b>E&amp;M Tie Line Basic Setup – E&amp;M Dial-In Mode</b></p> <p>Determine if the incoming Tie Line call should be directed as an intercom call (0) or if it should follow the DID Translation Table in Program 22-11 (1).</p>	<p>0 = Specify Extension Number (Intercom)</p> <p>1 = Use Conversion Table (NTT)</p>	0		✓	
34-01-04	<p><b>E&amp;M Tie Line Basic Setup – E&amp;M Line Dial Tone</b></p> <p>Enter 1 if the Tie Line should send dial tone to the calling system after the call is set up. Enter 0 if the Tie Line should not send dial tone.</p>	<p>0 = Disable (No)</p> <p>1 = Enable (Yes)</p>	1		✓	
34-02-01	<p><b>E&amp;M Tie Line Class of Service</b></p> <p>Assign a Class of Service (1 ~ 15) to a Tie Line. The Class of Service options are defined in Program 20-14. For each Tie Line, you make a separate entry for each Night Service mode.</p>	<p>Day/Night Mode</p> <p>1 ~ 8</p> <p>Class: 1 ~ 15</p>	1		✓	
34-09-01	<p><b>ANI/DNIS Service Options – Receive Format</b></p> <p>Specify the format of the ANI/DNIS data received from the Telco. Make sure your entry is compatible with the service the Telco provides (4 = *ANI*DNIS* [* = Delimiter Code]).</p> <p>➔ If Program 34-01-02 is set to (2) = MF, this Program works only as 4 = *ANI*DNIS*</p>	<p>0 = Address</p> <p>1 = *ANI*</p> <p>2 = *DNIS*</p> <p>3 = *ANI*Address*</p> <p>4 = *ANI*DNIS*</p> <p>5 = *DNIS*ANI*</p> <p>(* = Delimiter Code)</p>	COS 1 ~ 15 = 0		✓	
34-09-02	<p><b>ANI/DNIS Service Options – Delimiter Dial Code</b></p> <p>Define the character Telco uses as a delimiter (see entries 1 ~ 5 in Program 34-09-01). Valid entries are: 0 ~ 9, #, and *.</p>	0 ~ 9, #, and *.	COS 1 ~ 15 = *		✓	
34-09-03	<p><b>ANI/DNIS Service Options – Route Setup of Receive Dial</b></p> <p>Specify the source of the data the system uses to route incoming ANI/DNIS calls. If 2 is selected, refer to Program 34-09-04.</p>	<p>0 = Fixed Route (Item 08) (No Routing)</p> <p>1 = Routes on Received DNIS or Address Data</p> <p>2 = Routes on Received ANI Data</p>	COS 1 ~ 15 = 0		✓	

Program Number	Program Name/Description	Input Data	Default	Level		
				1	2	3
34-09-04	<p><b>ANI/DNIS Service Options – Route Table Setup of Target Dial</b></p> <p>Set how the system uses the route data (gathered in Item 03) to route incoming ANI/DNIS calls.</p> <p>If option 2 is selected and the call is routed using the DID table, up to eight digits can be matched. The number of expected digits set in Program 22-09-01 must match the ANI digits defined in Program 22-11-01. For example, if an ANI/DNIS number received was *2035551234*3001* and Program 22-09-01=4, then the entry in Program 22-11-01 must be 1234 with the defined target extension.</p> <p>If the call is routed using the ABB table (0), up to 24 digits can be matched. Define the range of the ABB table to be used in Program 34-09-06. The data is then compared to the entries in Program 13-04-01 and then routed according to Program 13-04-03.</p>	<p>0 = SPD Table (Program 13-03)</p> <p>1 = DID Table (Program 22-11)</p>	COS 1 ~ 15 = 0		✓	
34-09-05	<p><b>ANI/DNIS Service Options – ANI/DNIS Display as Target Dial Name</b></p> <p>Set whether or not ANI data should be displayed on telephone displays as part of Caller ID display.</p>	<p>Caller ID Display:</p> <p>0 = Display Off</p> <p>1 = Display On</p>	COS 1 ~ 15 = 0		✓	
34-09-06	<p><b>ANI/DNIS Service Options – Routing SPD Table Setup</b></p> <p>Define which part of the SPD Dial Table set up in Program 13-04 the system uses for ANI/DNIS Caller ID look-ups and ANI/DNIS routing (Start = 0, 100~9900, End = 0, 99 ~ 9999). This is required if Items 4 and 5 above are 1 (Caller ID on). When you specify a starting and end address, the system uses the part of the table for look-ups. When you specify a starting address and length, the system uses that part of the table for routing. If the incoming ANI/DNIS number data matches the Number entry in the table, the system routes according to the associated Name data. That data can be an extension, Department Group pilot number, the voice mail master number or a trunk ring group.</p>	<p>Start = 0, 100 ~ 9900</p> <p>End = 0, 99 ~ 9999</p>	<p>COS 1~15</p> <p>Start = 0</p> <p>End = 0</p>		✓	
34-09-07	<p><b>ANI/DNIS Service Options – Routing on ANI/DNIS Error</b></p> <p>Determine how the system handles an ANI/DNIS call if a data error is detected in the incoming data string.</p>	<p>0 = Play Busy Tone to Caller</p> <p>1 = Route Caller to Ring Group Specified in Program 25-03 (Transfer)</p>	COS 1 ~ 15 = 0		✓	

Program Number	Program Name/Description	Input Data	Default	Level		
				1	2	3
34-09-08	<b>ANI/DNIS Service Options – Routing When Destination Busy or No Answer</b> Determine how the system handles an ANI/DNIS call if destination is busy or does not answer.	0 = Play Busy or Ringback Tone to Caller (Busy/ NoAns) 1 = Route Caller to Ring Group Specified in Program 25-04 (Transfer)	COS 1 ~ 15 = 0		✓	
34-09-09	<b>ANI/DNIS Service Options – Calling Number Address Length</b> When Item 01 = 0 (ANI/DNIS receive format is address), specify the address length. The choices are 1 ~ 8 digits.	1 ~ 8	COS 1 ~ 15 = 7		✓	
34-10-01	<b>Digits Delete for T1 ANI Assignment</b> Define the number of digits to delete from the information element received from Telco.	0 ~ 9	2		✓	

## Operation

Refer to the operation for the following features:

- [Central Office Calls, Answering on page 2-206](#)
- [Central Office Calls, Placing on page 2-230](#)
- [Direct Inward Dialing \(DID\) on page 2-418](#)
- [Multiple Trunk Types on page 2-1162](#)

## Tandem Ringing

### Description

Tandem Ringing allows an extension user to have two telephones with one telephone number. For example, extension 105 (the master telephone) sets Tandem Ringing with extension 106. When extension 105 receives an incoming call, both extensions 105 and 106 ring. Callers would dial the master extension number (extension 105 in this example). When either the master telephone or slave telephone is in use, the other telephone cannot be used for outgoing calls or incoming calls.

The multiline terminal must be paired with a single line telephone. It cannot be paired with another multiline terminal.

A single line telephone must be paired with another single line telephone. It cannot be paired with a multiline telephone.

### Conditions

- The slave telephone cannot call the master telephone.
- DT800/DT700 IP Multiline terminals do not support Tandem Ringing.
- Extension numbers up to eight digits can be registered on the Tandem Ringing key. Extension numbers over nine digits cannot be registered.
- If Tandem Ringing is enabled, and one of the extensions is busy, no additional calls can be received or placed from either telephone.
- Tandem Ringing can support up to 128 pairs of Tandem Ringing extensions.
- The extension user which enables Tandem Ringing is the master, while the slave telephone is the extension entered by the user while setting up the feature.
- A slave telephone ignores the settings for DND and follows the master telephone settings instead.
- Voice Call is not supported on a multiline terminal with Tandem Ringing.
- Calls placed on Hold while Tandem Ringing is active, immediately recall if the handset is placed on-hook.
- A slave telephone ignores the settings for Ring Groups and follows the master telephone settings instead.
- To transfer calls between the two Tandem Ringing stations, a System Park Orbit should be used.
- A message waiting indication set for the master telephone only lights the message waiting LED on the master telephone.
- Tandem Ringing is not supported with extensions defined as Operator Extensions in Program 20-17-01.



## Default Setting

Disabled

## System Availability

### Terminals

Master Telephone:  
TDM Multiline Terminals or Single Line Telephones

Slave Telephone:  
Single Line Telephones

### Required Component(s)

None

## Related Features

- ↳ [Call Forwarding](#)
- ↳ [Call Forwarding/Do Not Disturb Override](#)
- ↳ [Direct Station Selection \(DSS\) Console](#)
- ↳ [Do Not Disturb](#)
- ↳ [Hold](#)
- ↳ [Intercom](#)
- ↳ [Message Waiting](#)
- ↳ [Multiple Trunk Types](#)
- ↳ [Ring Groups](#)

## Guide to Feature Programming

The **Level 1**, **Level 2** and **Level 3** columns indicate the programs that are assigned when programming this feature in the order they are most commonly used. These levels are used with PCPro and WebPro wizards for feature programming.

- Level 1 – these are the most commonly assigned programs for this feature.
- Level 2 – these are the next most commonly assigned programs for this feature.
- Level 3 – these programs are not often assigned and require an expert level working knowledge of the system to be properly assigned.

Program Number	Program Name/Description	Input Data	Default	Level		
				1	2	3
11-11-41	<b>Service Code Setup (for Setup/Entry Operation) – Tandem Ringing</b> Define a service code to be used to set up Tandem Ringing.	MLT, SLT 0 ~ 9, *, # Maximum of eight digits	No Setting		✓	
15-07-01	<b>Programmable Function Keys</b> Assign a function key for Tandem Ringing (code 80).	Line Key 1 ~ 48 0 ~ 99 (Normal Function Code 751 by default) *00 ~ *99 (Appearance Function Code) (Service Code 752 by default)	Refer to the Programming Manual for default values.		✓	
30-03-01	<b>DSS Console Key Assignment</b> Assign a DSS function key for Tandem Ringing (code 80).	Key Number 001 ~ 114 0 ~ 99 (General Functional Level) 97 = Door Box Access key (additional data: 1 ~ 8 Door Box No.) * 00 ~ * 99 (Appearance Functional Level)	Refer to the Programming Manual for default values.		✓	

## Operation

### To set up Tandem Ringing:

1. Press **Speaker** at the extension considered to be the master telephone (optional).
2. Press the Tandem Ringing key (Program 15-07 or SC 751: 80).
3. Dial **1** to set the feature.
4. Enter the extension number to be considered the slave telephone (the telephone that rings when the master extension rings).  
A confirmation tone is heard (if **Speaker** was used).

5. Press **Speaker** to hang up (if the key is lit).

While the feature is active, if either the master or slave telephone is on a call, no calls can be placed or answered at the other extension until the busy telephone has hung up. Multiline terminals indicate TANDEM IN USE in the display and single line telephone users hear a busy signal when the handset is lifted.

#### To cancel Tandem Ringing:

1. Press the Tandem Ringing key (Program 15-07 or SC 751: 80).
2. Dial **0** to cancel the feature.

## Tandem Trunking (Unsupervised Conference)

### Description

Tandem Trunking allows an extension user to join two outside callers in a Trunk-to-Trunk Conference. The extension user can then drop out of the call, leaving the trunks in an Unsupervised Conference. The extension user that established the conference is not part of the conversation. The conference continues until either outside party hangs up. The extension user that set up the conference can end the tandem call anytime.

The number of simultaneous conference calls is limited by the number of conference circuits in the system. The maximum number of conference calls cannot exceed the limits defined below:

The GCD-CP10 provides two blocks of 32 conference circuits, allowing each block to have any number of conferences with any number of internal or external parties conferenced as long as the total number of conference channels used does not exceed the block limit of 32.

Tandem Trunking could help an office manager, for example, put two outside sales people in touch. The office manager could:

- Answer a call from one salesperson
- Place a call to the second salesperson
- Set up the Trunk-to-Trunk Conference
- Drop out of the call



*The office manager could terminate the conference anytime.*

NOTE

Tandem Trunking methods include:

- Method A - Tandem Trunking from Conference  
An extension user can set up Tandem Trunking (Unsupervised Conference) by dialing a 2-digit service code (#8) or a uniquely programmed Transfer key.
- Method B - Tandem Trunking with Transfer Key  
This method allows an extension user to easily set up an Unsupervised Conference with a call they have placed on Hold. It uses a uniquely programmed Transfer key to set up a tandem call.
- Method C - Automatic Tandem Trunking on Hang Up  
This method allows an extension user to easily set up an Unsupervised Conference without having to place the conference call on Hold. A Class of Service option is available, which allows or denies an extension user from automatically setting up a Conference/Tandem Trunking call after hanging up the telephone.

#### ❑ Method D - Automatic Tandem Trunking Setup to Speed Dial Number

This method allows an extension user to easily set up an Unsupervised Conference with a call they have placed on Hold. A Class of Service option is available, which allows or denies an extension user from automatically setting up a Conference/Tandem Trunking call after hanging up the telephone.

### Trunk Continue/Disconnect Codes Added

Software enhances the forced trunk release option with the Tandem Trunking and DISA features. Users can use a Continue or Disconnect service code. The Continue service code extends the conversation a programmed time. If the user enters the Disconnect service code, the call is disconnected immediately.

#### EXAMPLE:

The following example indicates how a call is handled with the system programmed as follows:

- ❑ Program 14-01-25: 1 (Continued/Discontinued Trunk-to-Trunk Conversation)
  - ❑ Program 20-28-01: # (Conversation Continue Code)
  - ❑ Program 20-28-02: No Setting (No Conversation Disconnect Code is entered)
  - ❑ Program 20-28-03: 180 (Conversation Continue Time)
  - ❑ Program 24-02-07: 600 (Only used with Trunk-to-Trunk Transfer Release Warning Tone)
  - ❑ Program 24-02-10: 30 (Only used with Disconnect Trunk-to-Trunk)
  - ❑ Program 25-07-07: 600 (Long Conversation Warning Tone Timer)
  - ❑ Program 25-07-08: 30 (Long Conversation Disconnect)
1. An external call connects to an external number (either by transferring with Tandem Trunking or by DISA caller).
  2. After 10 minutes (Tandem Trunking = Program 24-02-07 or DISA = Program 25-07-07), a warning tone is heard and the user dials # (Program 20-28-01) to extend the conversation.
  3. After three minutes (Program 20-28-03), the warning tone is heard again. After 30 seconds (Tandem Trunking = Program 24-02-10 or DISA = Program 25-07-08), the call is disconnected.

### Conditions

- Tandem Trunking requires either loop start trunks with disconnect supervision or ground start trunks.
- The maximum number of simultaneous trunk-to-trunk conferences allowed is determined by the Conference feature setup. Refer to the [Guide to Feature Programming on page 2-1619](#) for this feature.
- The Continue/Disconnect code must be DTMF.
- With an analog trunk, the Continue/Disconnect code may work using DTMF sounds from the opposite side trunk. With an ISDN trunk, Program 14-01-25 must be enabled to detect the Continue/Disconnect code.
- The Continue/Disconnect code is not accepted while dialing a trunk.

- Continue/Disconnect codes do not work if all receivers are busy.
- When used with the Networking feature, both systems must be programmed the same for the Continue/Disconnect codes.
- A trunk can be set up to automatically tandem trunk/forward to an outside telephone number or Speed Dial – System/Group Dialing bin.
- Other programmed options for incoming and outgoing calls can affect how calls are handled. Refer to Central Office Calls, Answering/Central Office Calls, Placing and check or program these options as needed.
- DISA calls also use the same Continue/Disconnect codes.
- After initiating an unsupervised conference, selecting one of the CAP keys or line keys allows you to barge-in to the conference.
- If the station that barges into an unsupervised conference hangs up, the conference is terminated.
- A Trunk-to-Trunk transfer can be established by the following operation:
  1. While talking to an outside party, press **Hold**.
  2. Access a second outside line and dial the desired number.
  3. Press **Transfer** to complete the Trunk-to-Trunk transfer.
    - ◇ *When the second call is to be transferred to another station (Not Trunk-to-Trunk), the user should press **Hold** at step 3, then dial the desired station, and press **Transfer** to complete the transfer.*

## Default Settings

Disabled

## System Availability

### Terminals

All Multiline Terminals and Single Line Telephones

### Required Component(s)

None

## Related Features

➔ [Call Forwarding, Off-Premise](#)

- ➔ [Central Office Calls, Answering](#)
- ➔ [Central Office Calls, Placing](#)
- ➔ [Direct Inward System Access \(DISA\)](#)

## Guide to Feature Programming

The **Level 1**, **Level 2** and **Level 3** columns indicate the programs that are assigned when programming this feature in the order they are most commonly used. These levels are used with PCPro and WebPro wizards for feature programming.

- Level 1 – these are the most commonly assigned programs for this feature.
- Level 2 – these are the next most commonly assigned programs for this feature.
- Level 3 – these programs are not often assigned and require an expert level working knowledge of the system to be properly assigned.

### Method A – Tandem Trunking from Conference:

Program Number	Program Name/Description	Input Data	Default	Level		
				1	2	3
11-12-57	<b>Service Code Setup (for Service Access) – Tandem Trunking</b> If the default service code (#8) for Tandem Trunking is not acceptable, change the code as required.	MLT, SLT 0 ~ 9, *, # Maximum of eight digits	#8		✓	
14-01-04	<b>Basic Trunk Data Setup – Transmit Gain Level for Conference and Transfer Calls</b> Select the Transmit CODEC gain level used by the trunk when it is part of an Unsupervised Conference.	1 ~ 57 (-15.5dB ~ +12.5dB in 0.5dB intervals)	32 (0dB)		✓	
14-01-05	<b>Basic Trunk Data Setup – Receive Gain Level for Conference and Transfer Calls</b> Select the Receive CODEC gain level used by the trunk when it is part of an Unsupervised Conference.	1 ~ 57 (-15.5dB ~ +12.5dB in 0.5dB intervals)	16 (-8dB)		✓	
14-01-13	<b>Basic Trunk Data Setup – Trunk-to-Trunk Transfer</b> For each trunk that should be able to participate in a tandem call, enter 1.	0 = Disable 1 = Enable	1	✓		
15-07-01	<b>Programmable Function Keys</b> (Optional) Assign a function key for Transfer (code 06).	Line Key 1 ~ 48 0 ~ 99 (Normal Function Code 751 by default) *00 ~ *99 (Appearance Function Code) (Service Code 752 by default)	Refer to the Programming Manual for default values.		✓	

Program Number	Program Name/Description	Input Data	Default	Level		
				1	2	3
20-06-01	<b>Class of Service for Extensions</b> Assign a Class of Service (1 ~ 15) to an extension.	Day Night/Mode: 1 ~ 8 Class of Service of Extensions (1 ~ 15)	Extension port 101 = Class 15 All other extension port = Class 1	✓		
20-07-11	<b>Class of Service Options (Administrator Level) – Forced Trunk Disconnect (analog trunk only)</b> Turn Off or On an extension user ability to use Forced Trunk Disconnect. This allows the extension to disconnect an unsupervised conference in progress.	0 = Off 1 = On	COS 1~14 = 0 COS 15 = 1		✓	
20-11-14	<b>Class of Service Options (Hold/Transfer Service) – Trunk-to-Trunk Transfer Restriction</b> Turn Off or On the Trunk-to-Trunk Transfer Restriction. If enabled, Trunk-to-Trunk Transfer is not possible.	0 = Off 1 = On	COS 1 ~ 15 = 0		✓	
20-11-21	<b>Class of Service Options (Hold/Transfer Service) – Restriction for Tandem Trunking on Hang Up</b> Allow/Deny an extension user ability to set up a tandem call automatically when they hang up.	0 = Allow 1 = Deny	COS 1 ~ 15 = 0		✓	
20-11-22	<b>Class of Service Options (Hold/Transfer Service) – Restricted Unsupervised Conference</b> Allow/Deny an extension user ability to initiate an unsupervised conference.	0 = Allow 1 = Deny	COS 1 ~ 15 = 0		✓	
20-13-08	<b>Class of Service Options (Supplementary Service) – Conference</b> Turn Off or On extension user ability to initiate a conference or Meet Me Conference.	0 = Off 1 = On	COS 1 ~ 15 = 1	✓		
20-13-10	<b>Class of Service Options (Supplementary Service) – Barge-In Monitor</b> Enable the extension Barge-In Mode to be speech or Monitor mode.	0 = Speech 1 = Monitor	COS 1 ~ 15 = 0		✓	
24-02-07	<b>System Options for Transfer – Trunk-to-Trunk Transfer Release Warning Tone</b> This timer starts when a trunk begins talking with another trunk (for example: Trunk-to-Trunk Transfer, outgoing from trunk, Tandem Trunking). When this time expires, a warning tone is heard. If Program 24-02-10 is set, the conversation disconnects after time expires. This time is set again when the external digit time expires. One of the trunks used must be an analog trunk (or leased line).	0 ~ 64800 seconds	1800		✓	



Program Number	Program Name/Description	Input Data	Default	Level		
				1	2	3
24-02-10	<b>System Options for Transfer – Disconnect Trunk-to-Trunk</b> This timer starts after the Trunk-to-Trunk warning tone is heard.	0 ~ 64800 seconds	0		✓	
25-07-07	<b>System Timers for VRS/DISA – Long Conversation Warning Tone Time</b> Determine the time a DISA caller or any trunk-to-trunk (such as Tandem Trunking) conversation can talk before the Long Conversation tone is heard.	0 ~ 64800 seconds	3600		✓	
25-07-08	<b>System Timers for VRS/DISA – Long Conversation Disconnect Time</b> Determine the time the system waits before disconnecting a DISA caller or any trunk-to-trunk (such as Tandem Trunking) conversation call after the Long Conversation tone is heard.	0 ~ 64800 seconds	10		✓	

**Method B – Tandem Trunking with Transfer Key:**

Program Number	Program Name/Description	Input Data	Default	Level		
				1	2	3
14-01-04	<b>Basic Trunk Data Setup – Transmit Gain Level for Conference and Transfer Calls</b> Select the Transmit CODEC gain level used by the trunk when it is part of an Unsupervised Conference.	1 ~ 57 (-15.5dB ~ +12.5dB in 0.5dB intervals)	32 (0dB)		✓	
14-01-05	<b>Basic Trunk Data Setup – Receive Gain Level for Conference and Transfer Calls</b> Select the Receive CODEC gain level used by the trunk when it is part of an Unsupervised Conference.	1 ~ 57 (-15.5dB ~ +12.5dB in 0.5dB intervals)	16 (-8dB)		✓	
14-01-13	<b>Basic Trunk Data Setup – Trunk-to-Trunk Transfer</b> For each trunk, enter 1 to enable loop supervision.	0 = Disable 1 = Enable	1	✓		
15-07-01	<b>Programmable Function Keys</b> Assign a function key for Transfer (code 06).	Line Key 1 ~ 48 0 ~ 99 (Normal Function Code 751 by default) *00 ~ *99 (Appearance Function Code) (Service Code 752 by default)	Refer to the Programming Manual for default values.		✓	
20-06-01	<b>Class of Service for Extensions</b> Assign a Class of Service (1 ~ 15) to an extension.	Day Night/Mode: 1 ~ 8 Class of Service of Extensions (1 ~ 15)	Extension port 101 = Class 15 All other extension port = Class 1		✓	

Program Number	Program Name/Description	Input Data	Default	Level		
				1	2	3
20-07-11	<p><b>Class of Service Options (Administrator Level) – Forced Trunk Disconnect (analog trunk only)</b></p> <p>Turn Off or On an extension user ability to use Forced Trunk Disconnect. This allows the extension user to disconnect an Unsupervised Conference in progress.</p>	<p>0 = Off 1 = On</p>	<p>COS 1~14 = 0 COS 15 = 1</p>		✓	
20-11-14	<p><b>Class of Service Options (Hold/Transfer Service) – Trunk-to-Trunk Transfer Restriction</b></p> <p>Turn Off or On the Trunk-to-Trunk Transfer Restriction. If enabled, Trunk-to-Trunk Transfer is not possible.</p>	<p>0 = Off 1 = On</p>	<p>COS 1 ~ 15 = 0</p>		✓	
20-11-21	<p><b>Class of Service Options (Hold/Transfer Service) – Restriction for Tandem Trunking on Hang Up</b></p> <p>Allow/Deny an extension user ability to set up a tandem call automatically when they hang up.</p>	<p>0 = Allow 1 = Deny</p>	<p>COS 1 ~ 15 = 0</p>		✓	
20-13-10	<p><b>Class of Service Options (Supplementary Service) – Barge-In Monitor</b></p> <p>Allow/Deny an extension user ability to set up a tandem call automatically when they hang up.</p>	<p>0 = Speech 1 = Monitor</p>	<p>COS 1 ~ 15 = 0</p>		✓	
24-02-07	<p><b>System Options for Transfer – Trunk-to-Trunk Transfer Release Warning Tone</b></p> <p>This timer starts when a trunk begins talking with another trunk (for example: Trunk-to-Trunk Transfer, outgoing from trunk, Tandem Trunking).</p> <p>When this time expires, a warning tone is heard. If Program 24-02-10 is set, the conversation disconnects after time expires. This time is set again when the external digit time expires. One of the trunks used must be an analog trunk (or leased line).</p>	<p>0 ~ 64800 seconds</p>	<p>1800</p>		✓	
24-02-10	<p><b>System Options for Transfer – Disconnect Trunk-to-Trunk</b></p> <p>This timer starts after the Trunk-to-Trunk warning tone is heard.</p>	<p>0 ~ 64800 seconds</p>	<p>0</p>		✓	
25-07-07	<p><b>System Timers for VRS/DISA – Long Conversation Warning Tone Time</b></p> <p>Determine the time a DISA caller or any trunk-to-trunk (such as Tandem Trunking) conversation can talk before the Long Conversation tone is heard.</p>	<p>0 ~ 64800 seconds</p>	<p>3600</p>		✓	
25-07-08	<p><b>System Timers for VRS/DISA – Long Conversation Disconnect Time</b></p> <p>Determine the time the system waits before disconnecting a DISA or any trunk-to-trunk (such as Tandem Trunking) call after the Long Conversation tone is heard.</p>	<p>0 ~ 64800 seconds</p>	<p>10</p>		✓	

**Method C – Tandem Trunking on Hang up:**

Program Number	Program Name/Description	Input Data	Default	Level		
				1	2	3
14-01-04	<b>Basic Trunk Data Setup – Transmit Gain Level for Conference and Transfer Calls</b> Select the Transmit CODEC gain level used by the trunk when it is part of an Unsupervised Conference.	1 ~ 57 (-15.5dB ~ +12.5dB in 0.5dB intervals)	32 (0dB)		✓	
14-01-05	<b>Basic Trunk Data Setup – Receive Gain Level for Conference and Transfer Calls</b> Select the Receive CODEC gain level used by the trunk when it is part of an Unsupervised Conference.	1 ~ 57 (-15.5dB ~ +12.5dB in 0.5dB intervals)	16 (-8dB)		✓	
14-01-13	<b>Basic Trunk Data Setup – Trunk-to-Trunk Transfer</b> For each trunk, enter 1 to enable loop supervision.	0 = Disable 1 = Enable	1	✓		
20-06-01	<b>Class of Service for Extensions</b> Assign a Class of Service (1 ~ 15) to an extension.	Day Night/Mode: 1 ~ 8 Class of Service of Extensions (1 ~ 15)	Extension port 101 = Class 15 All other extension port = Class 1	✓		
20-07-11	<b>Class of Service Options (Administrator Level) – Forced Trunk Disconnect (analog trunk only)</b> Turn Off or On an extension user ability to use Forced Trunk Disconnect. This allows the extension user to disconnect an Unsupervised Conference in progress.	0 = Off 1 = On	COS 1~14 = 0 COS 15 = 1		✓	
20-11-11	<b>Class of Service Options (Hold/Transfer Service) – Automatic On-Hook Transfer</b> Turn Off or On the Trunk-to-Trunk Transfer Restriction. If enabled, Trunk-to-Trunk Transfer is not possible.	0 = Off 1 = On	COS 1 ~ 15 = 0	✓		
20-11-14	<b>Class of Service Options (Hold/Transfer Service) – Trunk-to-Trunk Transfer Restriction</b> Turn Off or On the Trunk-to-Trunk Transfer Restriction. If enabled, Trunk-to-Trunk Transfer is not possible.	0 = Off 1 = On	COS 1 ~ 15 = 0		✓	
20-11-21	<b>Class of Service Options (Hold/Transfer Service) – Restriction for Tandem Trunking on Hang Up</b> Allow/Deny an extension user ability to set up a tandem call automatically when they hang up.	0 = Allow 1 = Deny	COS 1 ~ 15 = 0		✓	

Program Number	Program Name/Description	Input Data	Default	Level		
				1	2	3
24-02-07	<p><b>System Options for Transfer – Trunk-to-Trunk Transfer Release Warning Tone</b></p> <p>This timer starts when a trunk begins talking with another trunk (for example: Trunk-to-Trunk Transfer, outgoing from trunk, Tandem Trunking).</p> <p>When this time expires, a warning tone is heard. If Program 24-02-10 is set, the conversation disconnects after time expires. This time is set again when the external digit time expires. One of the trunks used must be an analog trunk (or leased line).</p>	0 ~ 64800 seconds	1800		✓	
24-02-10	<p><b>System Options for Transfer – Disconnect Trunk-to-Trunk</b></p> <p>This timer starts after the Trunk-to-Trunk warning tone is heard.</p>	0 ~ 64800 seconds	0		✓	
25-07-07	<p><b>System Timers for VRS/DISA – Long Conversation Warning Tone Time</b></p> <p>Determine the time a DISA caller or any trunk-to-trunk (such as Tandem Trunking) conversation can talk before the Long Conversation tone is heard.</p>	0 ~ 64800 seconds	3600		✓	
25-07-08	<p><b>System Timers for VRS/DISA – Long Conversation Disconnect Time</b></p> <p>Determine the time the system waits before disconnecting a DISA or any trunk-to-trunk (such as Tandem Trunking) conversation call after the Long Conversation tone is heard.</p>	0 ~ 64800 seconds	10		✓	

**Method D – Tandem Trunking to Speed Dial Number:**

Program Number	Program Name/Description	Input Data	Default	Level		
				1	2	3
11-10-06	<p><b>Service Code Setup (for System Administrator) – Setting the Automatic Transfer for Each Trunk Line</b></p> <p>If the default service code (733) for enabling Automatic Tandem Trunking feature is not acceptable, change the code as required.</p>	MLT 0 ~ 9, *, # Maximum of eight digits	733		✓	
11-10-07	<p><b>Service Code Setup (for System Administrator) – Canceling the Automatic Transfer for Each Trunk Line</b></p> <p>If the default service code (734) for canceling Automatic Tandem Trunking feature is not acceptable, change the code as required.</p>	MLT 0 ~ 9, *, # Maximum of eight digits	734		✓	

Program Number	Program Name/Description	Input Data	Default	Level		
				1	2	3
11-10-08	<p><b>Service Code Setup (for System Administrator) – Setting the Destination for Automatic Trunk Transfer</b></p> <p>If the default service code (735) for setting the destination of the Automatic Tandem Trunking feature is not acceptable, change the code as required.</p>	<p>MLT 0 ~ 9, *, # Maximum of eight digits</p>	735		✓	
13-04-01	<p><b>Speed Dialing Number and Name – Speed Dialing Data</b></p> <p>Enter the number and name for the bins used to hold the Automatic Tandem Trunking destination.</p>	<p>Maximum of 24 digits. (1 ~ 9, 0, *, # Pause (Press line key 1) Recall/Flash (Press line key 2) @ = Code to wait for answer supervision in ISDN (Press line key 3)</p>	No Setting	✓		
13-04-02	<p><b>Speed Dialing Number and Name – Name</b></p> <p>Assign a name to each System Speed Dial bin.</p>	<p>Maximum of 12 characters (Use dial pad to enter name).</p>	No Setting		✓	
13-04-03	<p><b>Speed Dialing Number and Name – Transfer Mode</b></p> <p>Assign the transfer mode for each System Speed Dial bin.</p>	<p>0 = Not Used 1 = Internal Dial 2 = Incoming Ring Group (IRG)</p>	0		✓	
13-04-04	<p><b>Speed Dialing Number and Name – Transfer Destination Number</b></p> <p>Store transfer destination number data in the Speed Dialing areas.</p>	<p>Maximum of 24 characters If Transfer mode is (Refer to 13-04-03): 1 = Internal Dial Mode 1 ~ 9, 0, *, #, P, R, @ 2 = Incoming Ring Group 0 ~ 100 (IRG Number) P = Pause R = Recall @ = Additional Digits when using ISDN functionality</p>	No Setting		✓	
13-04-05	<p><b>Speed Dialing Number and Name – Incoming Ring Pattern</b></p> <p>Store incoming ring pattern data in the Speed Dialing areas.</p>	<p>Incoming Ring Pattern 0 = Normal Pattern 1 ~ 4 = Tone Pattern (1 ~ 4) 5 ~ 9 = Scale Pattern (1 ~ 5) 10 ~ 13 = Tone Pattern (5 ~ 8)</p>	0		✓	
14-01-04	<p><b>Basic Trunk Data Setup – Transmit Gain Level for Conference and Transfer Calls</b></p> <p>Select the Transmit CODEC gain level used by the trunk when it is part of an Unsupervised Conference.</p>	<p>1 ~ 57 (-15.5dB ~ +12.5dB in 0.5dB intervals)</p>	32 (0dB)		✓	
14-01-05	<p><b>Basic Trunk Data Setup – Receive Gain Level for Conference and Transfer Calls</b></p> <p>Select the Receive CODEC gain level used by the trunk when it is part of an Unsupervised Conference.</p>	<p>1 ~ 57 (-15.5dB ~ +12.5dB in 0.5dB intervals)</p>	16 (-8dB)		✓	

Program Number	Program Name/Description	Input Data	Default	Level		
				1	2	3
14-01-13	<b>Basic Trunk Data Setup – Trunk-to-Trunk Transfer</b> For each trunk, enter 1 to enable loop supervision.	0 = Disable 1 = Enable	1	✓		
20-06-01	<b>Class of Service for Extensions</b> Assign a Class of Service (1 ~ 15) to an extension.	Day Night/Mode: 1 ~ 8 Class of Service of Extensions (1 ~ 15)	Extension port 101 = Class 15 All other extension port = Class 1	✓		
20-07-05	<b>Class of Service Options (Administrator Level) – Set/Cancel Automatic Trunk-to-Trunk Transfer</b> Turn Off or On an extension user ability to use the Trunk-to-Trunk Forwarding service codes.	0 = Off 1 = On	COS 1 ~ 15 = 0	✓		
20-07-11	<b>Class of Service Options (Administrator Level) – Forced Trunk Disconnect (analog trunk only)</b> Turn Off or On an extension user ability to use Forced Trunk Disconnect. This allows the extension user to disconnect an Unsupervised Conference in progress.	0 = Off 1 = On COS 1~14 = 0 COS 15 = 1	COS 1~14 = 0 COS 15 = 1		✓	
24-02-07	<b>System Options for Transfer – Trunk-to-Trunk Transfer Release Warning Tone</b> This timer starts when a trunk begins talking with another trunk (for example: Trunk-to-Trunk Transfer, outgoing from trunk, Tandem Trunking). When this time expires, a warning tone is heard. If Program 24-02-10 is set, the conversation disconnects after time expires. This time is set again when the external digit time expires. One of the trunks used must be an analog trunk (or leased line).	0 ~ 64800 seconds	1800		✓	
24-02-10	<b>System Options for Transfer – Disconnect Trunk-to-Trunk</b> This timer starts after the Trunk-to-Trunk warning tone is heard.	0 ~ 64800 seconds	0		✓	
24-04-01	<b>Automatic Trunk-to-Trunk Transfer Target Setup</b> Assign the Speed Dialing number (0 ~ 9999) to be used as the destination for the Trunk-to-Trunk Transfer.	Trunks: 1 ~ 400 0 ~ 9999	9999	✓		
25-07-07	<b>System Timers for VRS/DISA – Long Conversation Warning Tone Time</b> Determine the time a DISA caller or any trunk-to-trunk (such as Tandem Trunking) conversation can talk before the Long Conversation tone is heard.	0 ~ 64800 seconds	3600		✓	

Program Number	Program Name/Description	Input Data	Default	Level		
				1	2	3
25-07-08	<b>System Timers for VRS/DISA – Long Conversation Disconnect Time</b> Determine the time the system waits before disconnecting a DISA or any trunk-to-trunk (such as Tandem Trunking) call after the Long Conversation tone is heard.	0 ~ 64800 seconds	10		✓	

**Trunk Disconnect Continue/Disconnect Codes:**

Program Number	Program Name/Description	Input Data	Default	Level		
				1	2	3
14-01-25	<b>Basic Trunk Data Setup – Continued/ Discontinued Trunk-to-Trunk Conversation</b> Enable/Disable the ability to dial a service code to continue or disconnect the trunk-to-trunk conversation after the alert tone is heard.	0 = Disable 1 = Enable	0	✓		
20-28-01	<b>Trunk to Trunk Conversation – Conversation Continue Code</b> Input the code that can be dialed to continue the conversation after the Trunk-to-Trunk Release Warning tone is heard.	0 ~ 9, #, *	No Setting		✓	
20-28-02	<b>Trunk to Trunk Conversation – Conversation Disconnect Code</b> Input the code that can be dialed to disconnect the conversation after the Trunk-to-Trunk Release Warning tone is heard.	0 ~ 9, #, *	No Setting		✓	
20-28-03	<b>Trunk to Trunk Conversation – Conversation Continue Time</b> Input the time the conversation extends when the Conversation Continue Code is dialed.	0 ~ 64800 seconds	0		✓	
24-02-07	<b>System Options for Transfer – Trunk-to-Trunk Transfer Release Warning Tone</b> This timer starts when a trunk begins talking with another trunk (for example: Trunk-to-Trunk Transfer/Tandem Trunking). When this time expires, a warning tone is heard. If Program 24-02-10 is set, the conversation disconnects after time expires. This time is set again when the external digit timer expires. One of the trunks used must be an analog trunk (or leased line).	0 ~ 64800 seconds	1800	✓		

Program Number	Program Name/Description	Input Data	Default	Level		
				1	2	3
24-02-10	<b>System Options for Transfer – Disconnect Trunk-to-Trunk</b> Determine the time a conversation continues after the timer in Program 24-02-07 expires. If this option is set to 0, the conversation is disconnected immediately. This program has no affect if Program 24-02-07 is set to 0. One of the trunks used must be an analog trunk (or leased line).	0 ~ 64800 seconds	0		✓	
25-07-07	<b>System Timers for VRS/DISA – Long Conversation Warning Tone Time</b> Determine the time a DISA caller or any trunk-to-trunk (such as Tandem Trunking) conversation can talk before the Long Conversation tone is heard.	0 ~ 64800 seconds	3600		✓	
25-07-08	<b>System Timers for VRS/DISA – Long Conversation Disconnect Time</b> Determine the time the system waits before disconnecting a DISA or any trunk-to-trunk (such as Tandem Trunking) conversation call after the Long Conversation tone is heard.	0 ~ 64800 seconds	10		✓	
80-01-02 (35)	<b>Service Tone Setup – Basic Tone Number</b> Edit the warning service tone in the system.	1 ~ 33 0 = No Tone 33 = Default Time Slot	Refer to the Programming Manual for default values.			✓

## Operation

### Method A – Tandem Trunking from Conference

**To set up a Tandem Call:**

1. Place or answer first trunk call.
2. Press **Conf** softkey.
3. Place or answer second trunk call.
4. To set up the tandem call, press **Conf** twice.
  - ◇ *This sets up a Conference between you and both outside parties.*
5. Press **Transfer**.

- OR -

Press **Hold** and dial **#8** or the service code set for Unsupervised Conference/Tandem Trunking in Program 11-12-57.

◇ *The line keys for the trunks blink green as long as the Unsupervised Conference continues.*



**To end the Tandem Call:**

1. Press either flashing **line** key.
  - ◇ *The line keys light steadily (green). You can listen (i.e., monitor) to the call or rejoin the conversation, based on the setting in Program 20-13-10.*
2. Press **Speaker** or hang up.
  - ◇ *If Program 20-13-10 is set to 0, the Conference ends and the line keys go out.*
  - ◇ *If Program 20-13-10 is set to 1, to manually disconnect the Conference, Forced Trunk Disconnect (i.e., Press the line key + \*3 or the service code set of Forced Trunk Disconnect in Program 11-10-26) must be used by an extension other than the originating extension.*

**Method B – Tandem Trunking with Transfer Key****Multiline Terminal:**To set up a Tandem Call:

1. Place or answer first trunk call.
2. Press **Hold** to place the first trunk call on hold.
3. Place a second trunk call.
4. Press **Transfer**.
  - ◇ *This sets up an Unsupervised Conference with both outside parties.*
  - ◇ *The line keys for the trunks light solid red.*
  - ◇ *To disconnect the Conference, use Forced Trunk Disconnect (i.e., Press the line key + \*3 or the service code set of Forced Trunk Disconnect in Program 11-10-26) must be used by an extension other than the originating extension.*

**Single Line Telephone:**To set up a Tandem Call:

1. Place or answer first trunk call.
2. Press hookflash and dial **#1**.
3. Place or answer second trunk call.
4. To set up the tandem call, press hookflash and dial **#8**.
5. Hang up.
  - ◇ *This sets up a Conference between both outside parties.*

## Method C – Tandem Trunking on Hang up

### Multiline Terminal:

#### To set up a Tandem Call:

1. Place or answer first trunk call.
2. Press **Hold** to place the first trunk call on hold.
3. Place a second trunk call.
4. Hang up.
  - ◇ *This sets up an Unsupervised Conference with both outside parties.*
  - ◇ *The line keys for the trunks light solid red.*
  - ◇ *To disconnect the Conference, use Forced Trunk Disconnect (i.e., Press line key + \*3 or the service code set of Forced Trunk Disconnect in Program 11-10-26).*

### Single Line Telephone:

#### To set up a Tandem Call:

1. Place or answer first trunk call.
2. Press hookflash.
3. Place or answer second trunk call.
4. To set up the tandem call, hang up.
  - ◇ *This sets up a Conference between both outside parties.*
  - ◇ *To disconnect the Conference, use Forced Trunk Disconnect [i.e., Dial the trunk access code (#9 + trunk number) + \*3 or the service code set of Forced Trunk Disconnect in Program 11-10-26].*

## Method D – Automatic Tandem Trunking Using Speed Dialing

### To set Automatic Tandem Trunking:

1. Dial service code **733** (or the service code set for Set Automatic Transfer per Trunk).
2. Dial the desired trunk number (Trunk Number: 001~400).
3. Hang up.
  - ◇ *The line key for the trunk is solid red as long as the Unsupervised Conference continues.*
  - ◇ *To disconnect the Conference, use Forced Trunk Disconnect (i.e., Press the line key or #9 plus the trunk number + \*3).*

### To cancel Automatic Tandem Trunking:

1. Dial service code **734** (or the service code set for Disable Automatic Transfer per Trunk).
2. Dial the desired trunk number (Trunk Number: 001~400).

3. Hang up.
  - ◇ To disconnect the Conference, Forced Trunk Disconnect (i.e., Press the line key or #9 plus the trunk number + \*3 or the service code set of Forced Trunk Disconnect in Program 11-10-26).

#### To set and change the destination of the Automatic Tandem Trunk call:

1. Dial service code **735** (or the service code set for Set Destination for Automatic Trunk-to-Trunk Transfer).
2. Dial the desired trunk number (Trunk Number: 001~400).
3. Dial the desired time mode (Time Mode: 1~8).
4. Dial the destination Number (trunk access code is not needed).
5. Press **Hold**.
6. Hang up.
  - ◇ To disconnect the Conference, use *Forced Trunk Disconnect* (i.e., Press the line key or #9 plus the trunk number + \*3).

#### Continue/Disconnect Codes

##### To use the Continue code to extend a Tandem Trunk call:

1. An external call connects to an external number either by transferring with Tandem Trunking or by DISA caller.
2. After the programmed time (Program 24-02-07), a warning tone is heard and the user dials the Continue code (Program 20-28-01) to extend the conversation.
3. After the programmed time (Program 20-28-03), the warning tone is heard again. After the programmed time (Program 24-02-10), the call is disconnected.

## TAPI Compatibility

### Description

The system has Telephony Applications Programming Interface (TAPI) compatibility that provides:

- Reduced TAPI Feature Set (see the Supported TAPI Commands chart below)
- Caller ID data to the PC for data base lookups and screen pops (see the Caller ID Data chart below)
- Telephone control (Off-Hook, On-Hook and dialing)

The 1st-Party TAPI Ethernet Driver provides an interface that allows the user personalized control of the telephone system from a desktop or laptop PC when used in conjunction with a TAPI-compliant application. The telephone system and PC are connected by installing an adapter on the telephone multiline terminal, allowing the PC user to access sophisticated communications services via the telephone lines.

### Conditions

- UC Desktop Suite does not support the Cordless DTL-8R-1 terminal.
- The Override function for IP multiline terminals and Softphones is supported.
- The Bluetooth Cordless Handset (BCH) is not a supported terminal when using 1st-Party CTI, 3rd-Party CTI, or with the Desktop Suite.
- A maximum of 256 1st-Party CTI over Ethernet connections is supported. Any Desktop Application connection takes away from the 256 maximum connections.
- Caller ID and Call status are available from the TAPI interface functions.
- Only one 3rd-Party CTI connection to the SV9100 is supported.
- Refer to [Table 2-136 TAPI Commands](#) for a list of supported TAPI commands.
- The TAPI Compatibility feature does not support CAP keys 4000~9999. Only 0001~3999 can be supported.
- DID name information of analogue trunk type will not be sent by TSP.
- SOAI and 3rd Party CTI can be used at the same time in the system.

*Table 2-136 TAPI Commands*

<b>lineAddProvider</b>	<b>lineAnswer</b>
<b>lineConfigDialog</b>	<b>lineBlindTransfer</b>
<b>lineGetAddressCaps</b>	<b>lineCompleteCall</b>
<b>lineGetDevCaps</b>	<b>lineCompleteTransfer</b>

Table 2-136 TAPI Commands (Continued)

<b>lineGetDevConfig</b>	<b>lineDevSpecific</b>
<b>lineGetIcon</b>	<b>lineDial</b>
<b>lineGetID</b>	<b>lineDrop</b>
<b>lineInitializeEx</b>	<b>lineForward</b>
<b>lineNegotiateAPIVersion</b>	<b>lineHold</b>
<b>lineNegotiateExtVersion</b>	<b>lineMakeCall</b>
<b>lineRemoveProvider</b>	<b>linePark</b>
<b>lineSetDevConfig</b>	<b>linePickup</b>
<b>lineShutdown</b>	<b>linePrepareAddToConference</b>
<b>lineClose</b>	<b>lineRedirect</b>
<b>lineDeallocateCall</b>	<b>lineRemoveFromConference</b>
<b>lineGetAddressStatus</b>	<b>lineSetupConference</b>
<b>lineGetCallInfo</b>	<b>lineSetupTransfer</b>
<b>lineGetCallStatus</b>	<b>lineSwapHold</b>
<b>lineGetLineDevStatus</b>	<b>lineUncompleteCall</b>
<b>lineOpen</b>	<b>lineUnhold</b>
<b>lineSetAppSpecific</b>	<b>lineUnpark</b>
<b>lineSetLineDevStatus</b>	<b>lineGatherDigits</b>
<b>lineSetMediaMode</b>	<b>lineGenerateDigits</b>
<b>lineSetStatusMessages</b>	<b>lineGenerateTone</b>
<b>lineMonitorDigits</b>	

- When SOAI (Simplified OAI, used by DT Plusware) and 3rd Party TAPI (i.e. Desktop Applications Shared Services) are used in the same system, the following limitations apply to only the SOAI application.
  - ❑ Multiple Call Handling (Operator Terminal, Call Queuing, etc.) is not supported for extensions controlled by SOAI.
  - ❑ SOAI controlled extensions cannot be the destination for Call Forward Both Ring or Tandem Ringing.
  - ❑ SOAI controlled extensions cannot have direct CO line keys (752: \*01).
  - ❑ SOAI controlled extensions do not support Park Holding.
  - ❑ SOAI controlled extensions cannot be used with the Mobile Extension feature.
  - ❑ CCIS Link Reconnect is not supported when SOAI and 3rd Party TAPI are used in the same system.

## Default Settings

Disabled

## System Availability

### Terminals

SV9100 Multiline Terminals and SV9100 SIP Multiline Terminals

### Required Component(s)

- GCD-CP10 should have LAN connection ability
- Compatible system software version
- PC Driver for the 1st-Party TAPI over Ethernet (CTE): PC running Windows XP 32-bit, or Windows 7 32-bit and 64-bit or Windows 8 32-bit and 64-bit.
- PC Driver for 3rd Party TAPI: PC Running Windows Server 2003 32-bit, Windows 2008 32-bit, Windows 2008 R2 64-bit, or Windows 2012 64-bit.
- A TAPI compatible Windows application

## Related Features

➔ **Headset Operation**

## Guide to Feature Programming

The **Level 1**, **Level 2** and **Level 3** columns indicate the programs that are assigned when programming this feature in the order they are most commonly used. These levels are used with PCPro and WebPro wizards for feature programming.

- Level 1 – these are the most commonly assigned programs for this feature.
- Level 2 – these are the next most commonly assigned programs for this feature.
- Level 3 – these programs are not often assigned and require an expert level working knowledge of the system to be properly assigned.

◇ *The items highlighted in gray are read only and cannot be changed.*

Program Number	Program Name/Description	Input Data	Default	Level		
				1	2	3
10-12-01	<b>GCD-CP10 Network Setup – IP Address</b> Assign the IP Address.	0.0.0.0 ~ 126.255.255.254 128.0.0.1 ~ 191.255.255.254 192.0.0.1 ~ 223.255.255.254	192.168.0.10	✓		
10-12-02	<b>GCD-CP10 Network Setup – Subnet Mask</b> The setting of Subnet Mask is invalid when all Host Addresses are 0. If the network section is: 0, 127, 128.0, 191.255, 192.0.0, 223.255.255 The setting of Subnet Mask is invalid.	128.0.0.0   192.0.0.0   224.0.0.0  240.0.0.0   248.0.0.0   252.0.0.0  254.0.0.0   255.0.0.0  255.128.0.0   255.192.0.0  255.224.0.0   255.240.0.0  255.248.0.0   255.252.0.0  255.254.0.0   255.255.0.0  255.255.128.0   255.255.192.0  255.255.224.0   255.255.240.0  255.255.248.0   255.255.252.0  255.255.254.0   255.255.255.0  255.255.255.128  255.255.255.192  255.255.255.224  255.255.255.240  255.255.255.248  255.255.255.252  255.255.255.254  255.255.255.255	255.255.0.0	✓		
10-12-03	<b>GCD-CP10 Network Setup – Default Gateway</b> Assign the default gateway IP address for the GCD-CP10.	0.0.0.0 ~ 126.255.255.254 128.0.0.1 ~ 191.255.255.254 192.0.0.1 ~ 223.255.255.254	0.0.0.0	✓		
10-20-01	<b>LAN Setup for External Equipment – TCP Port</b> Define the TCP port/address/etc. for communicating to external equipment.	0 ~ 65535	External Device 1 (CTI) = 0 External Device 2 (MIS) = 4000 External Device 5 (SMDR Output) = 0 External Device 6 (DIM Output) = 0 External Device 11 (O&M Server) = 8010 External Device 12 (Traffic Report Output) = 0 External Device 13 (Room Data Output for Hotel Service ) = 0	✓		

Program Number	Program Name/Description	Input Data	Default	Level		
				1	2	3
93-06-01	<b>IP Address List – IP Address of 1st Party CTI Client</b> Read only. Indicates IP Address of 1st Party CTI client.	IP Address: xxx.xxx.xxx.xxx	No Setting			
93-06-02	<b>IP Address List – Availability of 1st Party CTI Connection</b> Read only. Indicates Availability of 1st Party CTI client connection.	0 = Not Available 1 = Available	No Setting			

## Operation

TAPI operation is automatic once programmed in the telephone system and enabled in the PC TAPI application, unless a headset is used.

### Using the Headset with Automatic Answer:

1. With the multiline terminal in an idle state, press the Help key.
2. Press the **Headset** key (Program 15-07 or SC 751: 05) twice.
3. Press the **Exit** key to return the display to idle.
  - ◇ *The Headset key blinks when Automatic Headset is activated.*
  - ◇ *To cancel Automatic Headset, repeat these steps.*

### To redirect calls to the headset and disable the hookswitch (required for some TAPI features):

1. With the multiline terminal in an idle state, press the Help key.
2. Press the **Headset** key (Program 15-07 or SC 751: 05) twice.
3. Press the **Exit** key to return the display to idle.
  - ◇ *The Headset key blinks when Automatic Headset is activated.*
  - ◇ *To cancel Automatic Headset, repeat these steps.*
4. Press the **Headset** key (Program 15-07 or SC 751: 05) to go off-hook.



## Tone Override

### Description

The multiline terminal user that calls a busy station and receives a call waiting tone can generate a Tone Override that is heard by the originator and busy station. The busy station user can place the existing call on hold to answer the Override.

#### Conditions

- One Tone Override at a time can be received at a multiline terminal.
- Tone Override can be accomplished only after receiving a BUSY tone.
- Tone Override originate is allowed from a single line telephone until the PBR times out.
- Virtual Extensions do not support Tone Override.

#### Default Setting

None

### System Availability

#### Terminals

All Multiline Terminals

#### Required Component(s)

None

### Related Features

- ↳ [Call Waiting/Camp-On](#)
- ↳ [Data Line Security](#)

## Guide to Feature Programming

The **Level 1**, **Level 2** and **Level 3** columns indicate the programs that are assigned when programming this feature in the order they are most commonly used. These levels are used with PCPro and WebPro wizards for feature programming.

- Level 1 – these are the most commonly assigned programs for this feature.
- Level 2 – these are the next most commonly assigned programs for this feature.
- Level 3 – these programs are not often assigned and require an expert level working knowledge of the system to be properly assigned.

Program Number	Program Name/Description	Input Data	Default	Level		
				1	2	3
11-12-03	<b>Service Code Setup (for Service Access) – Override (Off-Hook Signaling)</b> Assign the service code used for off-hook Signaling Override.	MLT, SLT 0 ~ 9, *, # Maximum of eight digits	709		✓	
11-16-04	<b>Single Digit Service Code Setup – Intercom Off-Hook Signaling</b> Assign the one-digit service code used for off-hook Signaling.	0 ~ 9, *, # Maximum of one digit	*		✓	
15-02-12	<b>Multiline Telephone Basic Data Setup – Off-Hook Ringing</b> Set the telephone off-hook signaling that occurs when a telephone user receives a second call while busy on a handset call. To enable or disable off-hook signaling for an extension Class of Service, use Program 20-13-06.	0 = Muted Off-Hook Ringing 1 = No Off-Hook Ringing 2 = Not Used 3 = Beep in Speaker (SP) 4 = Beep in Handset (HS) 5 = Speaker & Handset Beep	5	✓		
15-07-01	<b>Programmable Function Keys</b> Assign a function key for off-hook Signaling (code 33).	Line Key 1 ~ 48 0 ~ 99 (Normal Function Code 751 by default) *00 ~ *99 (Appearance Function Code) (Service Code 752 by default)	Refer to the Programming Manual for default values.		✓	
20-06-01	<b>Class of Service for Extensions</b> Assign a Class of Service (1 ~ 15) to an extension.	Day Night/Mode: 1 ~ 8 Class of Service of Extensions (1 ~ 15)	Extension port 101 = Class 15 All other extension port = Class 1	✓		

Program Number	Program Name/Description	Input Data	Default	Level		
				1	2	3
20-09-01	<p><b>Class of Service Options (Incoming Call Service) – Second Call for DID/DISA/DIL/E&amp;M Override</b></p> <p>Turn Off or On an extension ability to receive a second call from a DID, DISA, DIL, or tie line caller.</p> <p>➤ <i>With this option set to 1, the destination extension must be busy for a second DNIS caller to ring through. If the destination extension does not have a trunk or CAP key available for the second call and a previous call is ringing the extension but has not yet been answered, the second caller hears busy regardless of this program setting.</i></p>	0 = Off 1 = On	COS 1 ~ 15 = 1	✓		
20-09-07	<p><b>Class of Service Options (Incoming Call Service) – Call Queuing</b></p> <p>Turn Off or On an extension user ability to have calls queued if a call rings the extension when it is busy.</p> <p>➤ <i>Program 20-13-06 must be set to 0 (Off) for this feature to work.</i></p>	0 = Off 1 = On	COS 1 ~ 15 = 1	✓		
20-13-05	<p><b>Class of Service Options (Supplementary Service) – Intercom Off-Hook Signaling</b></p> <p>Turn Off or On an extension ability to send off-hook signals.</p> <p>➤ <i>This setting functions with Programs 20-09-07 and 20-13-06 disabled.</i></p>	0 = Off 1 = On	COS 1 ~ 15 = 1	✓		
20-13-06	<p><b>Class of Service Options (Supplementary Service) – Automatic Off-Hook Signaling (Automatic Override)</b></p> <p>Allow a busy extension user to Manually (0) or Automatically (1) receive off-hook signals.</p> <p>➤ <i>This setting is to receive incoming call signaling information during call queuing.</i></p>	0 = Off 1 = On	COS 1 ~ 15 = 1	✓		
20-13-34	<p><b>Class of Service Options (Supplementary Service) – Block Manual Off-Hook Signaling</b></p> <p>Turn Off or On an extension user ability to block off-hook signals manually sent from a co-worker.</p>	0 = Off 1 = On	COS 1 ~ 15 = 0		✓	
20-13-35	<p><b>Class of Service Options (Supplementary Service) – Block Camp On</b></p> <p>Turn Off or On an extension user ability to block callers from dialing to camp-on.</p>	0 = Off 1 = On	COS 1 ~ 15 = 0		✓	
20-18-06	<p><b>Service Tone Timers – Interval of Call Waiting Tone</b></p> <p>Set the time between off-hook signaling alerts.</p>	0 ~ 64800 seconds	10		✓	

Program Number	Program Name/Description	Input Data	Default	Level		
				1	2	3
80-01-01 (39)	<b>Service Tone Setup – Basic Tone Number</b> Customize the service tones in the system. Tone Override is tone 39.		Refer to <a href="#">Table 2-33 Service Tone Setup Defaults, Program 80-01-01</a> on page 2-594.			✓
80-01-02 (39)	<b>Service Tone Setup – Ring Busy Tone</b> Define Ring Busy Tone.		Refer to <a href="#">Table 2-34 Service Tone Setup, Program 80-01-02</a> on page 2-598.			✓

## Operation

### To send Off-Hook signals to an extension busy on a call:



*Your extension may send Off-Hook signals automatically.*

NOTE

1. Dial \* (Program 11-16-04).  
- OR -  
Dial **709** (Program 11-12-02).  
- OR -  
Press the **Off-Hook Signaling** key (Program 15-07-01 code 33).  
◇ *You hear Ring Busy Tone.*  
◇ *The called extension hears Call Alert Notification.*

### To answer Tone Override:

1. Receive Tone Override.
2. Press **Hold** and talk with the party.

## Traffic Reports

### Description

The system can send data to a PC connected to the UNIVERGE SV9100. The telephone call traffic data for each extension is captured for use with the Station Message Detail Recording (SMDR) feature.

### Call Traffic

The total of outgoing call frequency, outgoing call duration, incoming call frequency, answer frequency, incoming call duration, ringing duration for each line and extension, and abandon call frequency for each line is logged. The total of incoming calls, answer frequency, call duration for each line and extension, and abandon call frequency of each line is logged and the data is outputted to the PC. The system totals the hour, day, week, and month for each terminal and trunk number. This information is used by the SMDR feature. The extension which is totaled is determined by system programming. The system outputs this data to the PC for the total period.

### Conditions

- The SMDR call buffer stores 4000 calls. The buffer stores calls when the SMDR device is unavailable. When the buffer fills, the oldest record is deleted to allow the new record to be saved.
- If connected to the output device, the reports print hourly. If not connected and the data is not output at the end of the hour, the traffic data is overwritten by new incoming data.
- The traffic data is lost if power failure occurs.
- Additional programming is required. Refer to the UNIVERGE SV9100 System Hardware Manual for more on setting up and connecting to the UNIVERGE SV9100 system.
- SMDR provides additional information about the system trunk calling patterns. Refer to [Station Message Detail Recording on page 2-1489](#) for more information.

### Default Settings

Disabled

### System Availability

#### Terminals

All Terminals

## Required Component(s)

Software Licenses for SMDR

### Traffic Total Report – Sample Report

Terminal	OTG	Duration	Cost	ICM	Answer	Duration	Ringing	Abandon
301	54	01:45:14	720	326	115	02:11:52	00:09:36	
301	92	02:37:22	1855	84	84	01:58:31	00:04:19	
LINE001	--	--	--	79	71	01:05:26	--	8

Term	Definition
Terminal	Terminal Number/Called Party Number (maximum 24 digits)
OTG	Outgoing Call Frequency/number of outgoing calls (maximum 65535 calls)
Duration	Call Duration for an Outgoing Call
Cost	Call Charge (Not Used)
ICM	Incoming Call Frequency/number of incoming calls (maximum 65535 calls)
Answer	Answer Frequency (maximum 65535 calls)
Duration	Call Duration for an Incoming Call
Ringing	Ringing Duration
Abandon	Number of Abandoned Calls (maximum 65535 calls)

## Related Features

↳ [Station Message Detail Recording](#)

## Guide to Feature Programming

The **Level 1**, **Level 2** and **Level 3** columns indicate the programs that are assigned when programming this feature in the order they are most commonly used. These levels are used with PCPro and WebPro wizards for feature programming.

- Level 1 – these are the most commonly assigned programs for this feature.
- Level 2 – these are the next most commonly assigned programs for this feature.
- Level 3 – these programs are not often assigned and require an expert level working knowledge of the system to be properly assigned.

Program Number	Program Name/Description	Input Data	Default	Level		
				1	2	3
10-20-12	<b>LAN Setup for External Equipment – TCP Port</b> Define the TCP port/address/etc. for communicating to external equipment.	0 ~ 65535	Refer to the Programming Manual for default values.	?		
90-20-01	<b>Traffic Report Data Setup – Call Traffic Output</b> Determine whether or not the Call Traffic Output should be measured.	0 = Not Measured 1 = Measure	0	✓		
90-21-01	<b>Traffic Report Output – Output Port Type</b> Define the output port to be used for the traffic reports. The reports print hourly when connected to the output device.	0 = No Setting 3 = LAN Port GCD-CP10	0	✓		

## Operation

None

## Description

Transfer permits an extension user to send an active Intercom or outside call to any other extension in the system. With Transfer, any extension user can quickly send a call to the desired co-worker. A call a user transfers, automatically recalls if not picked up at the destination extension. This assures that users do not lose or inadvertently abandon their transfers. While a transferred call is ringing an extension the system can optionally play ringback tone or Music on Hold to the caller.

The system allows the following types of transfers:

- Screened Transfer**  
The transferring user announces the call to the destination before hanging up.
- Unscreened Transfer**  
The transferring party extends the call without an announcement.
- Extension (Department) Groups Transfer**  
The Transferring party sends the call to a Department instead of an extension.
- Transfer Without Holding**  
A user presses a busy line key or the same (busy) CAP key and waits for the call to complete. The system automatically sends them the call when the internal caller hangs up.

### Automatic On-Hook Transfer Operation

With Automatic On-Hook Transfer, a transfer goes through as soon as the transferring user hangs up. For example, extension 104 can answer a trunk, press Transfer, dial 105 and hang up. The system extends the call to extension 105. Without Automatic On-Hook Transfer, the call would stay on Hold at extension 104 when the user hangs up. To extend the call, the user at extension 104 would have to press the Transfer key again before hanging up.

Each method has advantages. Automatic On-Hook Transfer makes transferring calls easier. However, users have to be more aware of how they handle their calls on Hold. Without Automatic On-Hook Transfer, extending a call becomes a two-step operation – but separate from placing calls on Hold.

### Prevent Recall of Transferred Call

The Class of Service program allows you to prevent a Transferred call from recalling the originating extension if the call is not answered.

### Transfer Call into Conference/Existing Call

This feature allows either a multiline terminal or single line telephone user with Barge-In ability to transfer a call into an existing call. This call can be a 2-party call, a Conference call, or a Barge-In Conference. The system allows Intercom and trunk calls to be transferred into a Conference call. This allows, for example, an attendant to locate co-workers and then transfer them into an existing telephone meeting. There is no need for the attendant to locate all the parties at the same time and sequentially add them into the Conference.



## Transfer to Trunk Ring Group Available

It is possible to transfer a trunk call to the trunk defined ring group (defined in Program 22-05-01: Incoming Trunk Ring Group Assignment). The trunk then rings the defined extensions for the ring group.

This also allows the transferred call to ring over the External Paging (Program 31-05: Universal Night Answer/Ring Over Page) so that an employee can answer the call from any available telephone.

To enable this feature, the system has a program option, Program 11-15-09: Service Code Setup Administrative (for Special Access) – Transfer to Trunk Ring Group Code (not assigned at default). When a call is transferred using this service code, it is transferred to the ring group destination for that incoming trunk. For example, trunk 2 is in Ring Group 4. When the call is transferred using this service code, the trunk rings all extensions programmed for Ring Group 4 or rings the External Paging Group for Ring Group 4, depending on how the system is programmed.

Program 22-04-01: Extension Ring Group Assignment and Program 22-05-01: Incoming Trunk Ring Group Assignment must be programmed to allow an extension access to the ring groups. If the call is not answered, it can overflow to the destination defined in Program 22-08-01: DIL/IRG No Answer Destination.

This service code can also be used with the VRS. This provides the caller listening to the VRS message with the ability to transfer their call and have it ring the external page. The code the caller would dial is defined in Program 25-06-02: VRS/DISA One-Digit Code Attendant Setup.

## Transfer Key Can Place Call on Hold

While on a call, press Transfer to place the call on hold.

### Conditions

- An existing call can be transferred into a call with Barge-In enabled.
- Unscreened Transfers from voice mail show pre-answer Caller ID information.
- With Transfer to Busy Extensions enabled (Program 24-02-01 = 1), Call Forwarding with Both Ringing offers a unique option. A transferred call waits for either the forwarding or destination extension to become free. The call goes through to the extension that first becomes available. If neither extension becomes free in the Transfer Recall Time, the call recalls the transferring extension.
  - ◇ *With Transfer to Busy Extensions disabled (Program 24-02-02 = 0), you must also set Program 20-09-07 for the extensions COS to 0 to disable call queuing and Program 20-13-06 to set Automatic Off-hook Signaling to manual.*
- An existing call can be transferred into a conference call.
- Meet Me Paging Transfer allows the user to page a co-worker and have the call automatically transferred when the co-worker answers the page.
- When transferring, an extension user can press a One-Touch key instead of dialing the extension number.

- Serial call allows transferring a call so it automatically returns to the transferring extension when completed.
- When a multiline terminal user is on a call, they can transfer to another station by pressing a DSS key for that station. It is not necessary to press Transfer to transfer to another station with a DSS key.
  - ◇ *When a multiline terminal user is on a call, they must press transfer to transfer a call off-site with a DSS key.*
- The following features require certain tones be changed in Program 80-01-02. Refer to the table in the [InMail on page 2-652](#) feature programming section for settings:
  - Call Holding
  - Busy Greeting
  - Call Screening
  - Await Answer Transfer
- A Trunk-to-Trunk transfer can be established by the following operation:
  1. While talking to an outside party, press **Hold**.
  2. Access a second outside line and dial the desired number.
  3. Press Transfer to complete the Trunk-to-Trunk transfer.
    - ◇ *When the second call is to be transferred to another station (Not Trunk-to-Trunk), the user should press Hold at step 3, then dial the desired station and press Transfer to complete the transfer.*
- If station A calls Station B, and station A puts station B on hold and then calls station C, station C cannot transfer the call.
- When transfer recall is disabled, unanswered transferred calls to a Virtual Extension or Virtual Loopback port will always recall once the transfer recall timer expires.
- SIP Centrex Transfer is not supported.

## Default Settings

Enabled

## System Availability

### Terminals

All Multiline Terminals

Required Component(s)

None

Related Features

- ↳ **Barge-In**
- ↳ **Caller ID**
- ↳ **Call Forwarding**
- ↳ **Call Waiting/Camp-On**
- ↳ **Conference**
- ↳ **Meet Me Paging Transfer**
- ↳ **One-Touch Calling**
- ↳ **Serial Call**

Guide to Feature Programming

The **Level 1**, **Level 2** and **Level 3** columns indicate the programs that are assigned when programming this feature in the order they are most commonly used. These levels are used with PCPro and WebPro wizards for feature programming.

- Level 1 – these are the most commonly assigned programs for this feature.
- Level 2 – these are the next most commonly assigned programs for this feature.
- Level 3 – these programs are not often assigned and require an expert level working knowledge of the system to be properly assigned.

Program Number	Program Name/Description	Input Data	Default	Level		
				1	2	3
11-12-58	<b>Service Code Setup (for Service Access) – Transfer into Conference</b> Assign the code a user dials to Transfer a call into a Conference call. This code is normally 624.	MLT, SLT 0 ~ 9, *, # Maximum of eight digits	624		✓	

Program Number	Program Name/Description	Input Data	Default	Level		
				1	2	3
11-15-09	<p><b>Service Code Setup Administrative (for Special Access) – Transfer to Incoming Ring Group</b></p> <p>When a call is transferred using this service code, it is transferred to the ring group destination for that incoming trunk. For example, trunk 2 is in Ring Group 4. When the call is transferred using this service code, the trunk rings all extensions programmed for Ring Group 4 or ring the External Paging Group for Ring Group 4, depending on how the system is programmed.</p>		No Setting		✓	
15-02-05	<p><b>Multiline Telephone Basic Data Setup – Transfer Key Operation Mode</b></p> <p>Set the operating mode of the extension Conf key. The keys can be for Call Transfer, Serial Calling or Flash. When selecting 2, refer also to Program 81-01-14.</p>	0 = Transfer 1 = Serial Call 2 = Flash	0		✓	
15-02-24	<p><b>Multiline Telephone Basic Data Setup – Conference Key Mode</b></p> <p>Program an extension Conf key for Conference or Transfer. When set for Transfer, the user places a call on hold, dials the extension to which it should be transferred, then presses Conf. The call is then transferred. When set for Conference, with an active call, the user can press Conf, place a second call, then press Conf twice. All the calls are then connected.</p> <p>➡ <i>This program is for UX5000 terminals only.</i></p>	0 = Conference 1 = Transfer	0		✓	
15-07-01	<p><b>Programmable Function Keys</b></p> <p>Extension users may want a function keys programmed for Transfer (code 06).</p>	Line Key 1 ~ 48 0 ~ 99 (Normal Function Code 751 by default) *00 ~ *99 (Appearance Function Code) (Service Code 752 by default)	Refer to the Programming Manual for default values.		✓	
20-02-04	<p><b>System Options for Multiline Telephones – Retrieve the Line After Transfer</b></p> <p>Enable/Disable an extension user ability to answer a call after it is transferred, but before it is answered.</p>	0 = Not Holding (No Keep) 1 = Holding (Keep)	1		✓	
20-03-01	<p><b>System Options for Single Line Telephones – SLT Call Waiting Answer Mode</b></p> <p>For a busy single line (500/2500 type) telephones, set the mode used to answer a camped-on trunk call.</p>	0 = Hookflash (Hooking) 1 = Hookflash + Service Code 794	0		✓	
20-06-01	<p><b>Class of Service for Extensions</b></p> <p>Assign a Class of Service (1 ~ 15) to extensions.</p>	Day Night/Mode: 1 ~ 8 Class of Service of Extensions (1 ~ 15)	Extension port 101 = Class 15 All other extension port = Class 1	✓		

Program Number	Program Name/Description	Input Data	Default	Level		
				1	2	3
20-09-07	<p><b>Class of Service Options (Incoming Call Service) – Call Queuing</b></p> <p>Turn Off or On an extension user ability to have calls queued if a call rings the extension when it is busy.</p> <p>➡ <i>Program 20-13-06 must be set to 0 (Off) for this feature to work.</i></p>	0 = Off 1 = On	COS 1 ~ 15 = 1	✓		
20-11-06	<p><b>Class of Service Options (Hold/Transfer Service) – Unscreened Transfer (Ring Inward Transfer)</b></p> <p>Turn Off or On an extension user ability to use Unscreened Transfer.</p>	0 = Off 1 = On	COS 1 ~ 15 = 1	✓		
20-11-07	<p><b>Class of Service Options (Hold/Transfer Service) – Transfer Without Holding</b></p> <p>Turn Off or On an extension user ability to use Transfer Without Holding.</p>	0 = Off 1 = On	COS 1 ~ 15 = 0	✓		
20-11-08	<p><b>Class of Service Options (Hold/Transfer Service) – Transfer Information Display</b></p> <p>Turn Off or On an extension ability for incoming Transfer preanswer display.</p>	0 = Off 1 = On	COS 1 ~ 15 = 1	✓		
20-11-11	<p><b>Class of Service Options (Hold/Transfer Service) – Automatic On-Hook Transfer</b></p> <p>Turn Off or On an extension user ability to use Automatic On-Hook Transfer.</p>	0 = Off 1 = On	COS 1 ~ 15 = 0		✓	
20-11-18	<p><b>Class of Service Options (Hold/Transfer Service) – No Recall</b></p> <p>No Recall set to 1 does not stop transferred calls from recalling from a virtual extension.</p>	0 = Off 1 = On	COS 1 ~ 15 = 0		✓	
20-11-20	<p><b>Class of Service Options (Hold/Transfer Service) – No Callback</b></p> <p>Turn Off or On an extension user ability to receive callbacks.</p>	0 = Off 1 = On	COS 1 ~ 15 = 0		✓	
20-13-06	<p><b>Class of Service Options (Supplementary Service) – Automatic Off-Hook Signaling (Automatic Override)</b></p> <p>Allow a busy extension to Manually (0) or Automatically (1) receive off-hook signals.</p> <p>➡ <i>This setting is to receive incoming call signaling information during call queuing.</i></p>	0 = Off 1 = On	COS 1 ~ 15 = 1	✓		
20-13-10	<p><b>Class of Service Options (Supplementary Service) – Barge-In Monitor</b></p> <p>Enable extension Barge-In as Speech or Monitor mode (i.e., Barge-In initiator). This is required to transfer a call to a conference.</p>	0 = Speech 1 = Monitor	COS 1 ~ 15 = 0		✓	
20-13-15	<p><b>Class of Service Options (Supplementary Service) – Barge-In, Initiate</b></p> <p>Turn Off or On an extension user ability to barge-in on other's calls.</p>	0 = Off 1 = On	COS 1 ~ 15 = 0		✓	

Program Number	Program Name/Description	Input Data	Default	Level		
				1	2	3
20-13-16	<b>Class of Service Options (Supplementary Service) – Barge-In, Receive</b> Turn Off or On an extension user ability to have other extensions Barge-In on calls.	0 = Off 1 = On	COS 1 ~ 15 = 0		✓	
20-13-17	<b>Class of Service Options (Supplementary Service) – Barge-In Tone/Display (Intrusion Tone)</b> Turn Off or On the Barge-In Tone. If set to 1, callers hear an alert tone and their display indicates the Barge-In when another extension barges into their conversation. If set to 0, there is no alert tone or display indication.	0 = Off 1 = On	COS 1 ~ 15 = 1		✓	
20-13-32	<b>Class of Service Options (Supplementary Service) – Deny Multiple Barge-Ins</b> Allow/Deny an extension user ability to have multiple users Barge-In to their conversation.	0 = Off 1 = On	COS 1 ~ 15 = 0		✓	
20-14-11	<b>Class of Service Options For DISA/E&amp;M – DISA/Tie Trunk Barge-In</b> Enable/Disable a DISA or tie trunk user ability to use Barge-In.	0 = Off 1 = On	COS 1 ~ 15 = 0		✓	
20-18-07	<b>Service Tone Timers – Intrusion Tone Repeat Time</b> After a call is interrupted (such as Barge-In, Voice Mail Conversation Recording or Voice Over) the system repeats the Intrusion tone after this time. Normally, you should enter 0.	0 ~ 64800 seconds	0		✓	
21-01-03	<b>System Options for Outgoing Calls – Trunk Interdigit Time (External)</b> The system waits for this time to expire before placing the call in a talk state (Call Timer starts after time expires, Voice Over and Barge-In are not allowed until after time expires).	0 ~ 64800 seconds	5		✓	
22-04-01	<b>Incoming Extension Ring Group Assignment</b> Assign extensions (up to 48) to Ring Groups. Calls ring extensions according to Ring Group programming. There are 100 available ring groups.	Maximum of eight digits.	Extensions 101 ~ 108 (first eight ports) ring for incoming Ring Group 1 calls. No other extensions ring for incoming Ring Group 1 calls.		✓	
22-05-01	<b>Incoming Trunk Ring Group Assignment</b> Define a trunk ring group. When transferring a DID or trunk call to the trunk defined ring group, the trunk then rings the defined extensions for the ring group.	Trunks 1 ~ 400 Incoming Group Number for Day/Night Mode (1 ~ 8): 0 = (No Setting) 001 ~ 100 = (Incoming Group) 102 = (In-Skin/ External Voice Mail or InMail)	1		✓	

Program Number	Program Name/Description	Input Data	Default	Level		
				1	2	3
22-08-01	<b>DIL/IRG No Answer Destination</b> Assign the DIL No Answer Ring Group where an unanswered call should overflow.	0 (No Setting) 001 ~ 100 (Incoming Ring Group) 102 (In-Skin/ External Voice Mail or InMail)	1		✓	
24-02-01	<b>System Options for Transfer – Busy Transfer</b> Enable/Disable an extension user ability to Transfer calls to busy extensions. If disabled, calls transferred to busy extensions recall immediately.	0 = Disable (No) 1 = Enable (Yes)	1		✓	
24-02-02	<b>System Options for Transfer – MOH or Ringback on Transferred Calls</b> Enable (0)/Disable (1) MOH on Transfer. If enabled, a transferred caller hears Music on Hold while their call rings the destination extension. If disabled, a transferred caller hears ringback while their call rings the destination extension. For this option to work with voice mail, the transferred call must be an unscreened transfer.	0 = Hold Tone 1 = Ring Back Tone	0		✓	
24-02-03	<b>System Options for Transfer – Delayed Call Forwarding Time</b> If activated at an extension, Delayed Call Forwarding occurs after this time. This also sets the time a Transferred call waits at an extension forwarded to Voice Mail before routing to the called extension mailbox.	0 ~ 64800 seconds	10		✓	
24-02-04	<b>System Options for Transfer – Transfer Recall Time</b> Set the Transfer Recall Time. An unanswered transferred call recalls to the extension that initially transferred it after this time.	0 ~ 64800 seconds	30		✓	
24-02-05	<b>System Options for Transfer – Message Wait Ring Interval Time</b> For Single Line Telephones (SLTs) without message waiting lamps, this is the time between intermittent ringing. If this value is 0, the system rings once.  ➡ <i>A release transfer to a busy Department Group only follows this time if the Department Group is set to 0 = No Queue in Program 16-01-10, if set to 1, 2 or 3 it follows the time in Program 24-02-04.</i>	0 ~ 64800 seconds	30		✓	

Program Number	Program Name/Description	Input Data	Default	Level		
				1	2	3
25-06-01	<p><b>VRS/DISA One-Digit Code Attendant Setup – Next Attendant Message Number</b></p> <p>Set up single digit dialing through the VRS. This gives VRS callers single-key access to extensions, the company operator, Department Calling Groups and Voice Mail. For each VRS message set to answer outside calls (see Program 25-02 and Program 25-05), you specify:</p> <ul style="list-style-type: none"> <li>○ The digit the VRS caller dials (0 ~ 9, *, #). (Keep in mind that if you assign destinations to digits, outside callers cannot dial system extensions, starting with that digit.</li> <li>○ The destination reached (eight digits maximum) when the caller dials the specified digit.</li> </ul> <p>The destination can be an extension, a Department Calling pilot number or the Voice Mail master number. A one-digit code can be assigned for each Automated Attendant message.</p>	<p>0 ~ 100 (0 = No Setting)                      101 = Voice Mail Answers                      104 = Refer to 25-04: VRS/DISA Transfer Ring Group with No Answer/ Busy                      105 = Dial the other extension                      106 = Record VRS</p>	0		✓	
25-06-02	<p><b>VRS/DISA One-Digit Code Attendant Setup – Destination Number</b></p> <p>Define the digit used by a VRS caller which allows their call to be transferred to the external page.</p>	Maximum of eight digits.	No Setting		✓	
31-05-01	<p><b>Universal Night Answer/Ring Over Page</b></p> <p>For each trunk which should ring the external page, set the External Page zone (1 ~ 9) to allow ringing.</p>	<p>0 = No Ringing (No)                      1 = Ringing (Yes)</p>	0		✓	

## Operation

### Transferring Trunk Calls

**To Transfer a trunk call to a co-worker’s extension:**

1. At the multiline terminal, press Transfer.

- OR -

At 500/2500 single line telephone, hookflash.

◇ *You hear Transfer dial tone.*



2. Dial the co-worker's extension number.
  - ◇ *If the extension is busy or does not answer, you can dial another extension number or press the line key to return to the call. In addition, you may be able to hang up and have the call Camp-On.*
  - ◇ *Single line telephone users can press hookflash to retrieve the call. If a call was transferred and the 500/2500 user has hung up the handset, the unanswered call can be retrieved by dialing \*\* and the extension number to which it had been transferred.*
3. Announce the call and press Transfer (Program 15-07 or SC 751: 06) or hang up.
  - ◇ *If you do not have Automatic On-Hook Transfer, you must press Conf (Program 15-02-24=1) or your Transfer Programmable Function Key to Transfer the call.*
  - ◇ *If your co-worker does not want the call, press the flashing line key to return to the call.*
  - ◇ *Single line telephone users can press hookflash to retrieve the call. If a call was transferred and the 500/2500 user has hung up the handset, only the unanswered call be can retrieved by dialing \*\* and the extension number to which it had been transferred.*
  - ◇ *If you do not want to screen the call, hang up without making an announcement.*

#### To answer a call transferred to your extension:

1. Lift the handset or press **Speaker** when a co-worker announces the call.

#### Transferring without Holding

##### To Transfer without holding (multiline terminal only):

1. Lift the handset.
2. Press busy line or press **Speaker**.
3. When original caller hangs up, you are connected.

#### Transferring Intercom Calls

##### To Transfer your Intercom call:

1. At the multiline terminal, press **Hold**.
  - OR -
  - At single line telephone, hookflash.
2. Dial extension to receive your call.
  - ◇ *If the extension is busy, does not answer or does not want the call, you can dial another extension number or press the lit line key to return to the call. In addition, you may be able to hang up and have the call Camp-On.*
  - ◇ *Single line telephone users can press hookflash to retrieve the call. If a call was transferred and the 500/2500 user has hung up the handset, only the unanswered call can be retrieved by dialing \*\* and the extension number to which it transferred.*

3. Announce your call and press Transfer (Program 15-07 or SC 751: 06) or hang up.

- ◇ **With Automatic On-Hook Transfer**  
*When you hang up, the call is automatically transferred.*

- ◇ **Without Automatic On-Hook Transfer**  
*You must press your Transfer Programmable Function Key to Transfer the call.*

*To Transfer the call unattended, press your Transfer Programmable Function Key and hang up without making an announcement.*

### Transferring a Call Into a Conference/Existing Call

1. While on a call, press **Transfer** and dial service code **624**.
  - ◇ *The display shows the Transfer to Conf. ICM Dial.*
2. Enter the extension number of the co-worker currently on a Conference call to which the call should be transferred.
  - ◇ *To cancel the transfer, press the flashing line key to retrieve the call.*
  - ◇ *If an error tone is heard, Barge-In is not enabled for the extension and the call does not go through. Press the flashing line key to retrieve the call or hang up, and the call recalls the extension.*
3. The transferred call is incorporated into the conference call.
  - ◇ *The callers hear the Barge-In tone if enabled in Program 20-13-17.*
  - ◇ *If a call is transferred into a Barge-In Conference (an existing 2-party call into which an extension user has used the Barge-In feature to join), the Conference becomes a regular 4-party Conference call.*
4. Hang up.

### Transferring a Call to a Trunk Ring Group:

1. While on a call, press **Transfer**.
2. Dial the **Transfer to Ring Group** service code defined in Program 11-15-09.
  - ◇ *You hear confirmation tone.*
3. Hang up.
  - ◇ *The call is transferred to the trunk ring group defined in Program 22-05-01 and all assigned extensions in the group (Program 22-04-01) ring or it rings the External Paging, enabling anyone to answer the call.*

### Transferring an Intercom or Trunk Call using a DSS/One-Touch Key:

1. While on a call, press the **DSS/One-Touch** key.
2. Announce the call or hang up.

## Trunk Groups

### Description

Trunk Groups let you optimize trunk usage for incoming and outgoing calls. Each group can be accessed by an Access Code plus the group number. There are 100 available Trunk Groups and you set the access order in trunk group programming. Using Call Appearance (CAP) Keys give an extension user more available function keys, since the user does not need a separate line key for each trunk.

Like Trunk Group Routing, Trunk Groups help you minimize the expense of toll calls. For example, if your system has outbound WATS lines, OCC lines and DDD lines, program the trunk group to route to the WATS lines first.

Priority	Type of Trunk
1	WATS
2	OCC
3	DDD

### Conditions

- Unless a user preselects a trunk, Trunk Group programming selects the trunk Speed Dialing used for trunk calls.
- If a user dials a number that is not programmed in ARS, the system can route the call to a trunk group.
- All DID trunks of the same type should be placed in the same trunk group. These trunk groups must then be assigned to a DID Translation Table.
- Trunks ring extensions according to Ring Group programming.

### Default Settings

All trunks are in group 1.

### System Availability

#### Terminals

All Terminals

#### Required Component(s)

None

## Related Features

- ➔ **Automatic Route Selection (ARS)**
- ➔ **Call Appearance (CAP) Keys**
- ➔ **Central Office Calls, Placing**
- ➔ **Dial Tone Detection**
- ➔ **Direct Inward Dialing (DID)**
- ➔ **Programmable Function Keys**
- ➔ **Ring Groups**
- ➔ **Speed Dial – System/Group/Station**
- ➔ **Trunk Group Routing**

## Guide to Feature Programming

The **Level 1**, **Level 2** and **Level 3** columns indicate the programs that are assigned when programming this feature in the order they are most commonly used. These levels are used with PCPro and WebPro wizards for feature programming.

- Level 1 – these are the most commonly assigned programs for this feature.
- Level 2 – these are the next most commonly assigned programs for this feature.
- Level 3 – these programs are not often assigned and require an expert level working knowledge of the system to be properly assigned.

Program Number	Program Name/Description	Input Data	Default	Level		
				1	2	3
10-09-01	<b>DTMF and Dial Tone Circuit Setup</b> Allocate the circuits on the GCD-CP10 for either DTMF receiving or dial tone detection.	0 = Common Use 1 = Extension Only 2 = Trunk Only	Circuit/Resource 01 ~ 08 = 1 (Extensions) Circuit/Resource 09 ~ 32 = 2 (Trunks) Circuit/Resource 33 ~ 144 = 0 (Common) When GPZ-BS10 is installed, 81 ~ 144 are available		✓	

Program Number	Program Name/Description	Input Data	Default	Level		
				1	2	3
11-12-14	<b>Service Code Setup (for Service Access) – Trunk Group Access</b> If the service code for Trunk Group Access (704 by default) is not acceptable, change it as necessary.	MLT, SLT 0 ~ 9, *, # Maximum of eight digits	704		✓	
14-02-11	<b>Analog Trunk Data Setup – Next Trunk in Rotary if No Dial Tone</b> Enable/Disable the system ability to skip over a trunk if dial tone is not detected. This pertains to calls using Speed Dial, ARS, Last Number Redial, or Save Number Dialed. It does not pertain to line keys or Direct Trunk Access calls.	0 = Disable 1 = Enable	0		✓	
14-05-01	<b>Trunk Group – Trunk Group Number</b> Assign trunks to trunk groups.	Trunk Port 1 ~ 400 Group Number 0 ~ 100 Priority 1 ~ 400	Default = Trunks 1 ~ 400 assigned to trunk group 1 with priorities equal to the trunk number. Trunk 1 = Priority 1 Trunk 400 = Priority 400.	✓		
14-06-01	<b>Trunk Group Routing – Priority Order Number</b> Set the priority order number 1 ~ 4.	0 = Not Specify 1 ~ 100: (Trunk Group Number) 101 ~ 150: (100 + Networking System Number) 1001 ~ 1100: (1000 + Route Table Number)	Route 1, Order Number 1 = 1 (Trunk Group 1) Order Numbers 2, 3, 4 = 0 (Not Specified) All Other Routes (2 ~ 100) and Order Numbers (1 ~ 4) = 0 (Not Specified).	✓		
14-07-01	<b>Trunk Access Map Setup – Trunk Port Number</b> Assign trunks to Access Maps.	0 = No access 1 = Outgoing access only 2 = Incoming access only 3 = Access only when trunk on Hold 4 = Outgoing access and access when trunk on Hold 5 = Incoming access and access when trunk on Hold 6 = Incoming and Outgoing access 7 = Incoming access, outgoing access and access when trunk on Hold Trunk Access Maps: 1 ~ 400	Access Maps 1 ~ 400 = Trunk Ports 1 ~ 400 assigned with option 7 access (incoming and outgoing access and access when trunk is on Hold).		✓	
15-06-01	<b>Trunk Access Map for Extensions</b> Assign Access Maps to extensions.	Trunk Access Maps: 1 ~ 400	1		✓	

Program Number	Program Name/Description	Input Data	Default	Level		
				1	2	3
15-07-01	<b>Programmable Function Keys</b> Assign function keys for trunk group access (code *02 + group) or Call Appearance (CAP) Keys (code *08 + CAP Key orbit 0001 ~ 9999 (or 0000 for auto assign).	Line Key 1 ~ 48 0 ~ 99 (Normal Function Code 751 by default) *00 ~ *99 (Appearance Function Code) (Service Code 752 by default)	Refer to the Programming Manual for default values.		✓	
20-02-02	<b>System Options for Multiline Telephones – Trunk Group Access Key Operating Mode</b> Set the operating mode of the extension trunk group keys.	0 = Outgoing / Incoming 1 = Outgoing 2 = Incoming	0		✓	
20-29-01	<b>Timer Class for Extension – Day/Night Mode 1~8, Class Number</b> Assign the timer class to each extension. There are 16 Classes that can be assigned. You make eight entries for this Program, one for each Night Service Mode. This entry includes virtual extension numbers.	0 ~ 15 0 = Not assigned	0		✓	
20-31-04	<b>Timer Class Timer Assignment – Intercom Interdigits Time (Intercom I/D Timer)</b> When placing Intercom calls, extension users must dial each digit in this time.	0 ~ 64800 seconds	10		✓	
21-01-02	<b>System Options for Outgoing Calls – Intercom Interdigit Time</b> When placing Intercom calls, extension users must dial each digit in this time.	0 ~ 64800 seconds	10		✓	
21-01-05	<b>System Options for Outgoing Calls – Disconnect Time When Dial Tone Not Detected</b> If 14-02-11 is enabled, the system skips over a trunk if dial tone is not detected. This option pertains to calls placed using Speed Dial, ARS, Last Number Redial or Save Number dialed. It does not pertain to line key or Direct Trunk Access calls.	0 ~ 64800 seconds	3		✓	

## Operation

### To place a call over a trunk group:

1. At the multiline telephone, press **Speaker**.  
- OR -  
At the single line telephone, lift the handset.
2. Dial **704**.
3. Dial trunk group number (1~9 or 001~100).

4. Dial number.

- OR -

1. Press the **Trunk Group** key (Program 15-07 or SC 752: \*02 + group).
2. Dial the number.

**To answer an incoming trunk group call:**

1. Lift the handset.
2. Press the flashing **Trunk Group** key.

## Trunk Group Routing

### Description

Trunk Group Routing sets outbound call routing options for users that dial the Trunk Group Routing code (9) for trunk calls. Trunk Group Routing routes calls in the order specified by system programming. If a user dials 9 and all trunks in the first group are busy, the system may route the call to another group. When you are setting up your system, Trunk Group Routing helps you minimize the expense of toll calls. For example, if your system has outbound WATS lines, OCC lines and DDD lines, use Trunk Group Routing to route calls to the WATS lines first.

There are 100 available Trunk Groups and 100 Routes.

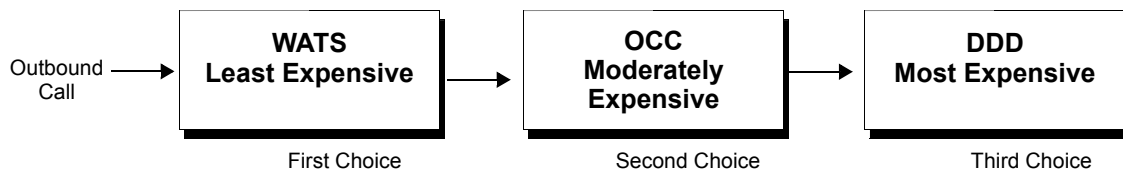

### Conditions

- DISA (Program 25-10) and Tie Lines (Program 34-03) have separate Trunk Group Routing programs.
- The system uses Trunk Group Routing programming (Program 14-06) when setting up Ringing Line Preference.
- Use trunk group programming to set the order in which users access trunks within a specific trunk group.
- Dialing 9 activates ARS, overriding trunk group routing if ARS service is turned on.
- Call Forwarding, Off-Premise is not supported when using Alternate Trunk Group Routing.

### Default Settings

Enabled (All trunks are in Group 1)

### System Availability

#### Terminals

All Terminals



Required Component(s)

None

Related Features

- ↳ [Automatic Route Selection \(ARS\)](#)
- ↳ [Central Office Calls, Placing](#)
- ↳ [Dial Tone Detection](#)
- ↳ [Direct Inward Dialing \(DID\)](#)
- ↳ [Multiple Trunk Types](#)
- ↳ [Prime Line Selection](#)
- ↳ [Programmable Function Keys](#)
- ↳ [Trunk Groups](#)

Guide to Feature Programming

The **Level 1**, **Level 2** and **Level 3** columns indicate the programs that are assigned when programming this feature in the order they are most commonly used. These levels are used with PCPro and WebPro wizards for feature programming.

- Level 1 – these are the most commonly assigned programs for this feature.
- Level 2 – these are the next most commonly assigned programs for this feature.
- Level 3 – these programs are not often assigned and require an expert level working knowledge of the system to be properly assigned.

Program Number	Program Name/Description	Input Data	Default	Level		
				1	2	3
11-01-01	<b>System Numbering – Service Code</b> Set up a Service Code for Alternate Trunk Route Access.	Set up a Service Code for Alternate Trunk Route Access.	Refer to the Programming Manual for default values.		✓	
11-09-01	<b>Trunk Access Code – Trunk Access Code</b> If required, change the single-digit Trunk Access Code (normally 9). This is the code extension users dial to access Automatic Route Selection. If you change this code, you must make corresponding changes in Program 11-01.	Dial (maximum of four digits)	9		✓	

Program Number	Program Name/Description	Input Data	Default	Level		
				1	2	3
11-09-02	<b>Trunk Access Code – 2nd Trunk Route Access Code</b> Define additional trunk access codes. When a user dials the Alternate Trunk Route Access Code, the system routes their call to the Alternate Trunk Route.	Dial (maximum of four digits)	No Setting		✓	
14-05-01	<b>Trunk Group – Trunk Group Number</b> Assign trunks to trunk groups.	Trunk Port 1 ~ 400 Group Number 0 ~ 100 Priority 1 ~ 400	Default = Trunks 1 ~ 400 assigned to trunk group 1 with priorities equal to the trunk number. Trunk 1 = Priority 1 Trunk 400 = Priority 400.	✓		
14-06-01	<b>Trunk Group Routing – Priority Order Number</b> Set the priority order number (1 ~ 4).	0 = Not Specify 1 ~ 100: (Trunk Group Number) 101 ~ 150: (100 + Networking System Number) 1001 ~ 1100: (1000 + Route Table Number)	Route 1, Order Number 1 = 1 (Trunk Group 1) Order Numbers 2, 3, 4 = 0 (Not Specified) All Other Routes (2 ~ 100) and Order Numbers (1 ~ 4) = 0 (Not Specified).	✓		
14-07-01	<b>Trunk Access Map Setup – Trunk Port Number</b> Access Map programming may limit Trunk Group Routing options.	0 = No access 1 = Outgoing access only 2 = Incoming access only 3 = Access only when trunk on Hold 4 = Outgoing access and access when trunk on Hold 5 = Incoming access and access when trunk on Hold 6 = Incoming and Outgoing access 7 = Incoming access, outgoing access and access when trunk on Hold Trunk Access Maps: 1 ~ 400	Access Maps 1 ~ 400 = Trunk Ports 1 ~ 400 assigned with option 7 access (incoming and outgoing access and access when trunk is on Hold).		✓	
15-06-01	<b>Trunk Access Map for Extensions</b> Access Map programming may limit Trunk Group Routing options.	Trunk Access Maps: 1 ~ 400	1		✓	
15-07-01	<b>Programmable Function Keys</b> Assign a function key for Trunk Group Routing access (code *02 + trunk group #).	Line Key 1 ~ 48 0 ~ 99 (Normal Function Code 751 by default) *00 ~ *99 (Appearance Function Code) (Service Code 752 by default)	Refer to the Programming Manual for default values.		✓	

Program Number	Program Name/Description	Input Data	Default	Level		
				1	2	3
21-02-01	<b>Trunk Group Routing for Extensions</b> Assign the trunk routes to extensions.	Trunk Group Routes: 1 ~ 100 Day/Night Mode: 1 ~ 8 Route Table Number: 0 ~ 100 (0 = No Setting)	1		✓	
21-15-01	<b>Individual Trunk Group Routing for Extensions</b> Designate the trunk route accessed when a user dials the Alternate Trunk Route Access Code assigned in Program 11-09-02. Trunk Group Routing is set up in Program 14-06.	Trunk Group Routes: 1 ~ 100 0 ~ 100 (0 = No Setting)	0		✓	
23-03-01	<b>Universal Answer/Auto Answer</b> Let an extension user automatically answer trunk calls that ring other extensions. When the user lifts the handset, they automatically answer the ringing calls based on Trunk Group Routing programming (defined in Program 14-06).	Day/Night Mode 1 ~ 8 Route Table Number 0 ~ 100	0		✓	
25-10-01	<b>Trunk Group Routing for DISA</b> Assign the Trunk Group Route chosen when a user places a DISA call into the system and dials 9. The Trunk Group Routing is defined in Program 14-06. If the system has ARS, dialing 9 accesses ARS. The route chosen is based on the DISA Class of Service, which is determined by the password the caller dials.	Trunk Group Routes: 1 ~ 100 Day/Night Mode = 1 ~ 8 Route Table Number = 0 ~ 100 (0 = No Setting)	1		✓	
25-12-01	<b>Alternate Trunk Group Routing for DISA</b> Define the trunk route selected when a DISA caller dials the Alternate Trunk Access Code assigned in Program 11-09-02. The route selected is based on the DISA caller Class of Service, which is in turn determined by the password the caller dials. Program 14-06 is used to set up the Trunk Group Routing.	Trunk Group Routes: 1 ~ 100 Day/Night Mode = 1 ~ 8 Route Table Number = 0 ~ 100 (0 = No Setting)	1		✓	
34-03-01	<b>Trunk Group Routing for E&amp;M Tie Lines</b> Assign the Trunk Group Route chosen when a user seizes a Tie Line and dials 9. Set Trunk Group Routing in Program 14-06. If the system has ARS, dialing 9 accesses ARS.	Trunk Group Routes: 0 ~ 100 (0 = No Setting)	1		✓	

## Operation

### To place a call using Trunk Group Routing:

1. At the multiline terminal, press **Speaker**.

- OR -

At single line telephone, lift the handset.

2. Dial **9**.
3. Dial number.

- OR -

1. At the multiline terminal, press Trunk Group Routing key (Program 15-07 or SC 752: \*05).  
◇ Also refer to the [Call Appearance \(CAP\) Keys on page 2-140](#).
2. Dial the number.

## Trunk Queuing/Camp-On

### Description

Trunk Queuing permits an extension user to queue (wait in line) on-hook for a busy trunk or trunk group to become free. The system recalls the queued extension as soon as the trunk is available. The user does not have to manually retry the trunk later. Trunk Queuing lets the caller know when the call can go through. If the extension user does not answer the Trunk Queuing ring, the system cancels the queue request.

With Trunk Camp-On, an extension user can queue (wait in line) *Off-Hook* for a busy trunk or trunk group to become free. The caller connects to the trunk when the trunk becomes free. As with Trunk Queuing, the user does not have to manually retry the trunk later.

Any number of extensions may simultaneously queue or Camp-On for the same trunk or trunk group. When a trunk becomes free, the system connects the extensions in the order that the requests were left.

### Conditions

- With Automatic Route Selection (ARS), Trunk Queuing automatically queues for the least costly route.
- A user can camp-on or leave a callback request for an extension.
- Other programmed options for outgoing calls can affect how a call is placed. Check or program these options as needed (e.g., access line/Call Appearance (CAP) Keys, etc.).
- Using a Programmable Function Key can simplify the trunk queuing operation.

### Default Settings

Enabled

### Related Features

- ➔ [Automatic Route Selection \(ARS\)](#)
- ➔ [Callback](#)
- ➔ [Call Waiting/Camp-On](#)
- ➔ [Central Office Calls, Placing](#)
- ➔ [Programmable Function Keys](#)

## Guide to Feature Programming

The **Level 1**, **Level 2** and **Level 3** columns indicate the programs that are assigned when programming this feature in the order they are most commonly used. These levels are used with PCPro and WebPro wizards for feature programming.

- Level 1 – these are the most commonly assigned programs for this feature.
- Level 2 – these are the next most commonly assigned programs for this feature.
- Level 3 – these programs are not often assigned and require an expert level working knowledge of the system to be properly assigned.

Program Number	Program Name/Description	Input Data	Default	Level		
				1	2	3
11-12-04	<b>Service Code Setup (for Service Access) – Set Camp-On</b> Customize the Service Code used for setting Camp-On.	MLT, SLT 0 ~ 9, *, # Maximum of eight digits	750		✓	
11-12-05	<b>Service Code Setup (for Service Access) – Cancel Camp-On</b> Customize the Service Code, used for cancelling Camp-On.	MLT, SLT 0 ~ 9, *, # Maximum of eight digits	770		✓	
11-16-05	<b>Single Digit Service Code Setup – Camp-On</b> Customize the 1-digit Service Code used for setting Camp-On.	0 ~ 9, *, # Maximum of one digit	#		✓	
15-07-01	<b>Programmable Function Keys</b> Assign a function key for Trunk Queuing and Trunk Camp-On (code 35).	Line Key 1 ~ 48 0 ~ 99 (Normal Function Code 751 by default) *00 ~ *99 (Appearance Function Code) (Service Code 752 by default)	Refer to the Programming Manual for default values.	✓		
20-01-08	<b>System Options – Trunk Queuing Callback Time</b> Set the Trunk Queuing Callback Time. Trunk Queuing Callback rings an extension for this time.	0 ~ 64800 seconds	15		✓	
20-01-09	<b>System Options – Callback/Trunk Queuing Cancel Time</b> Set the Callback/Trunk Queuing Cancel Time. The system cancels an extension Callback or Trunk Queuing request after this time.	0 ~ 64800 seconds	64800		✓	
20-06-01	<b>Class of Service for Extensions</b> Assign a Class of Service (1 ~ 15) to an extension.	Day Night/Mode: 1 ~ 8 Class of Service of Extensions (1 ~ 15)	Extension port 101 = Class 15 All other extension port = Class 1		✓	
20-11-07	<b>Class of Service Options (Hold/Transfer Service) – Transfer Without Holding</b> Turn Off or On an extension user ability to use Transfer Without Holding.	0 = Off 1 = On	COS 1 ~ 15 = 0		✓	

Program Number	Program Name/Description	Input Data	Default	Level		
				1	2	3
20-29-01	<b>Timer Class for Extensions</b> Assign the timer class (0 ~ 15) to each extension for each Night mode. This entry includes virtual extension number.	0 ~ 15 0 = Not assigned	0		✓	
20-31-01	<b>Timer Class Timer Assignment – Trunk Queuing Callback Duration Time</b> Trunk Queuing Callback rings an extension for this time.	0 ~ 64800 seconds	15		✓	
20-31-02	<b>Timer Class Timer Assignment – Callback / Trunk Queuing Cancel Time</b> The system cancels an extension Callback or Trunk Queuing request after this time.	0 ~ 64800 seconds	64800		✓	
21-01-18	<b>System Options for Outgoing Calls – Reset Dial After Failure of Trunk Access</b> Enable/Disable an extension user ability to continue to dial codes or extensions after receiving Trunk Busy. This must be set to 0 for the Forced Trunk Disconnect feature to work.	0 = Enable 1 = Disable	1	✓		

## Operation

### To queue for a busy trunk:

1. Try to access the busy trunk.
2. Dial # or 750.  
- OR -  
Press Trunk Queuing/Camp-On key (Program 15-07 or SC 751: 35).
3. Hang up to leave a Trunk Queuing request.  
- OR -  
Wait Off-Hook to Camp-On to the trunk.

### To answer when Trunk Queuing calls you back:

1. Lift the handset.

### To cancel a Trunk Queuing/Camp-On request:

1. At the multiline terminal, press idle **Speaker**.  
- OR -  
At the single line telephone, lift the handset.

2. Dial **770**.
3. At the multiline terminal, press **Speaker** to hang up.

- OR -

At the single line telephone, hang up.



### Description

The UM8000 Mail voice mail system, using the UNIVERGE SV9100 system and a Local Area Network, provide Unified Messaging services for voice, fax and email messages with access at either the desktop PC or the telephone. Unified Messaging lets the PC control telephone calls and information about each inbound and outbound call.

Automated Attendant automatically answers the system incoming calls. After listening to a customized message, an outside caller can dial a system extension or use Voice Mail.



NOTE

*At default the system is programmed to use the built in InMail voice mail. By programming the UM8000 to work in the SV9100 it becomes the primary voice mail.*

Integrated Voice Mail enhances the telephone system with the following features:

#### Expanded Schedules

The UM8000 Mail has three schedules (1-3) and each schedule has an A, B and C option. It also has 99 custom schedules that are available in addition to the three standard schedules. Each custom schedule can support a maximum of nine time intervals

These schedules can be applied to Opening Boxes, Transaction Boxes and Voice Detect Boxes. You can also assign a supported box type to inherit its schedule from the previous box the call came from or from the voice mail port the call came in on. This flexibility allows for much more detailed scheduling of different groups within a system. The new Expanded Schedules provide the following:

- A maximum of 99 Custom Schedules.
- A maximum of nine time intervals per schedule.
- Each schedule can be set to follow or ignore holidays.
- The following box types can use custom schedules:
  - Opening Boxes
  - Transaction Boxes
  - Voice Detect Boxes
- Boxes can be configured to follow:
  - One of the three standard schedules.
  - A particular custom schedule.
  - Inherit their schedule from the previous box.
  - Inherit their schedule from the voice mail port the call came in on.
  - The All hours All Day schedule, this schedule is fixed to Day Mode.

Call Forwarding to Voice Mail

An extension user can forward their calls to Voice Mail. Once forwarded, calls to the extension connect to that extension mailbox. The caller can leave a message in the mailbox instead of calling back later. Forwarding can occur for all calls immediately, for unanswered calls or only when the extension is busy. When a user transfers a call to an extension forwarded to Voice Mail, the call waits for the Delayed Call Forwarding time before routing to the called extension mailbox. This gives the transferring party the option of retrieving the call instead of having it go directly to the mailbox.

 Leaving a Message

Voice Mail lets a multiline terminal extension user easily leave a message at an extension that is unanswered, busy or in Do Not Disturb. The caller presses their Voice Mail key to leave a message in the called extension mailbox. There is no need to call back later.

 Transferring to Voice Mail

By using Transfer to Voice Mail, a multiline terminal extension user can Transfer a call to their own or a co-worker's mailbox. After the Transfer goes through, the caller can leave a message in the mailbox.

 Live Record

While on a CO/Trunk call, an extension user can have Voice Mail record the conversation. The multiline terminal user presses the Voice Mail Record key; the single line telephone user dials a code. Once recorded, the Voice Messaging System stores the conversation as a new message in the user's mailbox. After calling their mailbox, a user can save, edit or delete the recorded conversation. The Live Record feature is supported only for External CO/Trunk calls. Internal/Intercom calls are not supported.

 Live Monitor

A multiline terminal user can have their idle extension emulate a personal answering machine. This lets the UM8000 screen their calls, just like their answering machine at home. If activated, the extension incoming calls route to the user's subscriber mailbox. The Live Monitor feature is supported for external and internal calls. After the mailbox answers, the user's phone changes to show that a caller is leaving a message, no audible tone is provided. The multiline terminal user can then:

- Choose **Exit** to let the call go through to their mailbox.
- Choose **ANSW** to intercept the call before it goes to their mailbox.
- Choose **MON** to monitor the message being left by the caller.

 Voice Mail Overflow

If Voice Mail automatically answers trunks, Voice Mail Overflow can reroute those trunks to other extensions when all Voice Mail ports do not answer or, with certain software, are busy. During periods of high traffic, this prevents the outside calls from ringing Voice Mail for an inordinate amount of time. There are two types of Voice Mail Overflow: Immediate and Delayed. With immediate overflow, calls immediately reroute to other extensions when all Voice Mail ports do not answer or, with certain software, are busy. With delayed overflow, calls reroute after a preset interval. Without any type of overflow, the outside calls ring Voice Mail until a port becomes available or the outside caller hangs up.

#### ❑ Voice Mail Caller ID

The Voice Mail can use ANI/DNIS information to identify the outside caller that left a message in a user's mailbox. When the message recipient dials 0 or presses the CID softkey while listening to a message, they hear the outside telephone number of the message sender.

The message recipient can also return the call from their mailbox if allowed by system programming by pressing the CALL softkey or #,0. Press **Speaker** to hang up.

#### ❑ Quick Transfer to Voice Mail

A station user transferring a call can transfer the call to the called party voice mail box after an internal station number is dialed while performing a screened transfer, or during intercom calls.

The user simply calls the extension and then dials the quick transfer dial access code (default = 8) and hangs up. The call is placed in the mailbox and the caller hears the personal greeting.

### Voice Mail Queuing

When accessing the voice mail, the system provides a voice mail queue. If all the voice mail ports are busy, any call trying to get to the voice mail is placed in queue. As the voice mail ports become available, the calls are connected to the voice mail in the order in which they were received.

As the Voice Mail Queue follows Department Hunting programming, the queue can hold a maximum of 10 calls. If the queue is full or if the voice mail ports are not assigned to a Department Group, the calls are handled as though there were no voice mail queuing feature enabled. The calls either access voice mail if a port is available or they receive a busy signal.

The Voice Mail Queuing feature does not work with the Conversation Record feature.

### Message Key will Operate as Voice Mail Key

The system enhances a telephone Message key function when connected to a system which has voice mail installed. When an extension receives a voice mail, the Message key can be used to check the number of messages in voice mail, or call the voice mail to listen to the messages. If no Voice Mail Programmable Function Key is defined (Program 15-07-01, code 77), the telephone Message Waiting LED flashes to indicate new messages.

This option is not available with a networked voice mail – the voice mail must be local.

### Directory Dialing

Directory Dialing allows an Automated Attendant caller to reach an extension by dialing the first few letters in the extension user's name. With Directory Dialing, the caller does not have to remember the extension number of the person they wish to reach – just their name. Here is how Directory Dialing works:

1. When the Automated Attendant answers, it sends the call to the Main Greeting box. The caller must dial a digit to access Directory Dialing.
2. The Directory Dialing Mailbox plays the Directory Dialing Message which asks the caller to dial letters for the name of the person they wish to reach.

3. The caller dials the first three letters for the person's name. They can dial by first name or last name, depending on how the Directory Dialing Message was recorded and the Directory Dialing Mailbox was set up.
4. Voice Mail searches the list of programmed extension names for a match of the caller-entered letters.
5. The caller dials the digit for the extension they wish to reach, and Voice Mail sends the call to that extension. The call is sent as a Screened or Unscreened transfer, depending on programming.

For callers to use Directory Dialing, the system must have a name programmed for each extension. Each extension should also have a name recorded in their Subscriber Mailbox. In addition, each extension used by Directory Dialing must be installed.

### Optional UM8000 Mail TeLANophy Module Features

#### Text-to-Speech Using Nuance<sup>®</sup> RealSpeak<sup>™</sup>

The UM8000 Text-to-Speech (TTS) package enables subscribers to have 24-hour, two-way access to Microsoft Exchange, Novell GroupWise, or Lotus Notes Email messages without a laptop or modem connection. Subscribers can manage email messages using a telephone. Subscribers can listen to any plain text email message using TTS conversion and record a reply that is sent as a voice mail message or an email message with a WAV file attachment. Subscribers use touchtone keypads over a phone to reply, redirect, save and delete email messages, making subscribers more efficient and accessible when they are away from the office.

#### ViewMail<sup>®</sup> with Live Record Module

All voice and fax messages are visible at a glance on the PC screen and can be sorted in any order. An intuitive Microsoft<sup>®</sup> Windows interface shows the sender name, subject, and the date and time messages were sent so the user can quickly prioritize them and respond immediately.

#### ViewFax<sup>®</sup>

The fax feature works in ViewMail (VM) and View Mail for Microsoft Messaging (VMM) to display faxes on screen and lets you send them to any printer. When a fax is received, a fax icon is displayed next to the message in VM/VMM. Double click to open the message, and press the play button to listen to any voice annotation sent with the fax. Fax ports are built-in on the GCD-VM00 based UM8000 Mail and are activated as a system licensing option. Fax on Demand and Fax Server functions are not supported.

- A maximum of four fax ports are supported on the UM8000 Mail.

#### Hospitality Package

The Hospitality package is used specifically by hotels and resorts to provide guests with personal, accurate, and timely messages. Features include personal greetings, security codes, guest directory, and wake up calls. This feature also supports Property Management System (PMS) integration.

#### Additional Hospitality Languages

See Multilingual support below for list of supported languages. The Hospitality Package supports five languages at default. Additional languages can be purchased (up to the limit of 10).

Networking

This allows the networking of multiple Active Net (AMIS Only) and PlusNet compatible voice mails systems.

Multilingual Support

Add Languages, only United States English is on the drive at default. New languages can be added in the field from the support CD. Additional languages can be added in the field with an upgrade code.

The UM8000 supports three languages (American English, Mexican Spanish and Canadian French) by default. Both systems can support a maximum of 23 active languages. However, if all language prompts are loaded, recording time is severely reduced. For an installation requiring 23 languages, 8G or higher media is recommended.

Supported Languages:

- |                                |   |
|--------------------------------|---|
| <b>ar = Argentinean</b>        | <b>ja = Japanese (hospitality only)</b> |
| <b>au = Australian English</b> | <b>la = Latin America Spanish</b>       |
| <b>ca = Catalan Spanish</b>    | <b>md = Mandarin Chinese</b>            |
| <b>ct = Cantonese Chinese</b>  | <b>nl = Dutch</b>                       |
| <b>de = German</b>             | <b>nz = New Zealand English</b>         |
| <b>dk = Danish</b>             | <b>pi = Iberian Portuguese</b>          |
| <b>ed = Madrid Spanish</b>     | <b>pt = Portuguese</b>                  |
| <b>es = Mexican Spanish</b>    | <b>se = Swedish</b>                     |
| <b>fc = Canadian French</b>    | <b>uk = UK English</b>                  |
| <b>fr = Parisian French</b>    | <b>us = US English</b>                  |
| <b>he = Hebrew</b>             | <b>ru = Russian</b>                     |
| <b>it = Italian</b>            |   |

EMail Integration

With email integration, subscribers can forward all voice messages to their email inbox automatically and forward all incoming faxes to their email inbox as well. Email integration provides users with 24-hour access to email from any touchtone phone. Email integration uses standard protocols to access, read and send email messages on the voice messaging system.



*When voice messages forwarded to an email address using email integration are deleted from the user mailbox the following features are not supported: Pager Notification, Message Waiting Indication.*

The following email protocols are supported:

IMAP

Internet Message Access Protocol (IMAP) allows the voice messaging system to access an email inbox. Using IMAP, the voice messaging system can obtain email message headers and body information from a variety of email users. This information is then delivered to the text-to-speech engine to convert the text into audio for playback.

## ○ MIME

Multipurpose Internet Mail Extension (MIME), ensures that the voice messaging system can read the message header and body information. Multipart MIME messages enable the email system to send enhanced versions of the message for messaging clients such as Lotus Notes or Microsoft Outlook. In addition, multipart MIME messages contain plain text messages that can be read to subscribers over the phone.



*If HTML tags are heard when listening to an email message by phone, the system skips the message. Messages encoded only in HTML are not supported by text-to-speech at this time. Messages containing HTML must be encoded using multipart MIME for text-to-speech to work properly.*

## ○ SMTP

Simple Mail Transport Protocol (SMTP), sends outgoing email messages to email boxes using the voice messaging system. The Forward voice mail to the email system, Forward faxes to the email system, Receive email notification of new fax/voice mail and Reply to email messages via voice mail features use SMTP to send outgoing messages. SMTP can also be configured to restrict the type of messages sent, such as only allowing SMTP mail to be sent to other users on the same domain. Refer to your Exchange, Domino, or GroupWise documentation, or consult your administrator on which settings work best for your organization.

## Conditions

- With Version 11.9.0.12 or higher, the UM8000 Mail supports IP integration to Lua PMS for hotel features when properly licensed.
- One UMS Client License (1404) is required for each subscriber mailbox, guest mailbox and hotel guest mailbox. Transaction, operator and interview boxes do not require a UMS Client license.
- Additional mailbox licenses can be added using part number 640814.
- When using Message Waiting on line key (Program 15-07 or SC 751: 77 + mailbox number) with a UM8000, softkeys are not provided when logging into a UM8000 mailbox.
- The UM8000 Voice Mail is not supported in the SV9100-S system.
- The Expanded Schedule feature has the following conditions:
  - A maximum of 99 Custom Schedules are supported.
  - A maximum of nine time intervals per custom schedule are supported to set multiple day or week and hour of day options.
  - If two time intervals within a customer schedule contradict each other the numerically lower time interval is followed.
- Constant Message Count is displayed on a telephone's display until another activity needs the display (For instance, if a call is made or received on the telephone). To get the message count to display again, the telephone needs to receive a new voice mail message or call into the voice mailbox.
- The GCD-VM00 supports one media size: 8G with 550 Hours of recording time.
- Live Record does not work for monitored calls, conference calls or internal calls.

- Audible tones are **not** provided to the multiline terminal when using Live Monitor, only visual notifications are provided for incoming monitored calls.
- A maximum of four fax ports are supported on the UM8000.
- Fax on demand is not supported.
- Fax server is not supported.
- The UM8000 supports up to 23 languages and 10 Hospitality languages.
- Caller ID Return Call may require ARS programming to properly route outgoing calls.
- Updating the system time also updates the UM8000 Mail time.
- When setting up hunt group priorities in 16-02-01 the VM ports must be assigned as port 1 = priority 1, port 2 = priority 2 and so on. Failure to do this causes the VM to answer but no audio is heard.
- The Live Record feature is supported only for External CO/Trunk calls. Internal/Intercom calls are not supported.
- The Live Record feature is supported only for Multiline telephones. Single Line Telephones do not support this feature.
- The following databases can be migrated to the UM8000:
  - OS/2 based EliteMail CTI
  - DOS based EliteMail Q51731 or higher
  - Linux based EliteMail CTI LX
  - Linux based EliteMail CTI LX Lite
- Voice messages forwarded to an email address using email integration can be set to be automatically deleted, saved as new or saved as old, in a user's mailbox.
- When a mailbox is set to delete or save as old voice messages forwarded to an email address using email integration, the following features are not supported: Pager Notification, Message Waiting Indication.
- Email integration refers to forwarding voice messages to an email server and does not apply to the client applications ViewMail®, VMM, VMG and VML.
- The operating system is Linux.
- Extension numbers cannot start with 0 or 9.
- Extension numbers cannot include \* or #.
- InMail and UM8000 Mail cannot be used at the same time in the same system.
- Ring Group calls do not follow extension call forwarding to voice mail.
- Caller ID information is passed from the voice mail to an extension for pre-answer display on an unscreened transfer from voice mail.
- Off-premise notification and external extensions require access to outside lines.



- To have the Voice Mail Automated Attendant answer a trunk, program the trunk as a DIL to the Voice Mail pilot.
- When the voice mail places a call on hold, it uses Group Hold. Any line appearances for the trunk shows the hold flash rate, however, users cannot pick up these calls (a busy signal is heard).
- If the Message Waiting LED is also used for Message Waiting Indication, and there are both voice mail messages and Message Wait indications, the color set for Message Wait overrides the color used for voice mail indications (red).
- During a Conversation Record session, DTMF digits are not transmitted. If the End softkey is used to stop the Conversation Record, DTMF to the outside party is restored. If you press the Conversation Record button to end the recording DTMF is not restored.
- Stutter Dial Tone is supported to Single Line Telephones (SLTs) for Voice Mail Message Waiting.
- When a Department Group is assigned as the VM Department Group in Program 45-01-01 it works only as priority mode no matter what Program 16-01-02 is set to for that Department.
- A modem for remote maintenance is built into the GCD-VM00 blade.
- When the system has the Hotel Motel license (0007), the Message Waiting Indication (MWI) on a DSS Console for an extension is a Green LED. Without the Hotel Motel license the MWI on a DSS Console for an extension is a Red LED.
- When migrating from SV8100 to SV9100, the InMail auto programs to use Department Group 64. For example, if Department Group 64 was previously being used on the SV8100 for UM8000, the UM8000 will need to be re-programmed to use a different Department Group.

## Default Settings

Disabled

## System Availability

### Terminals

All Terminals

### Required Component(s)

- GCD-VM00
- UM8000 Mail Media Kit
- 0411 – SV9100 Version Lic



- 0300 – SV9100 Resource Lic
- 1404 – SV91/SV93 UM8000 UMS Client Lic, one UMS Client license per subscriber mailbox, guest mailbox and hotel guest mailbox

## Required Software

When using ViewMail for Microsoft Messaging (VMM) with Office XP/2002 or Office 2000 you must have at least Service Pack 3 for Office installed prior to installing VMM. Failure to do so requires removing and installing the entire Office software suite again. Microsoft Outlook needs Corporate or Workgroup version.

The following versions of Microsoft Outlook work with VMM:

- Outlook 2007 (Vista 32-bit only)
- Outlook 2010 (Windows 7 32- and 64-bit)
- Outlook 2013 (32- and 64-bit)

The supported TeLANophy applications include:

- ViewMail
- ViewMail for Microsoft Messaging (VMM)
- ViewFax (VF)

These TeLANophy applications work on the following operating systems:

- Windows 7 (32- and 64-bit)
- Windows 8 (32- and 64-bit)

## Related Features

- ➔ [Barge-In](#)
- ➔ [Caller ID](#)
- ➔ [Call Forwarding](#)
- ➔ [Central Office Calls, Answering](#)
- ➔ [Central Office Calls, Placing](#)
- ➔ [Direct Inward Line \(DIL\)](#)
- ➔ [Hold](#)
- ➔ [Message Waiting](#)

- ➔ **One-Touch Calling**
- ➔ **Programmable Function Keys**
- ➔ **Transfer**

## Guide to Feature Programming

The **Level 1**, **Level 2** and **Level 3** columns indicate the programs that are assigned when programming this feature in the order they are most commonly used. These levels are used with PCPro and WebPro wizards for feature programming.

- Level 1 – these are the most commonly assigned programs for this feature.
- Level 2 – these are the next most commonly assigned programs for this feature.
- Level 3 – these programs are not often assigned and require an expert level working knowledge of the system to be properly assigned.

Program Number	Program Name/Description	Input Data	Default	Level		
				1	2	3
<b>10-09-01</b>	<b>DTMF and Dial Tone Circuit Setup</b> Assign at least one circuit for DTMF reception (type 0 or 1). Use the following as a guide when allocating DTMF receivers: <ul style="list-style-type: none"> <li>○ In light traffic sites, allocate one DTMF receiver for every 10 devices that use them.</li> <li>○ In heavy traffic sites, allocate one DTMF receiver for every five devices that use them.</li> </ul>	0 = Common Use 1 = Extension Only 2 = Trunk Only	Circuit/Resource 01 ~ 08 = 1 (Extensions) Circuit/Resource 09 ~ 32 = 2 (Trunks) Circuit/Resource 33 ~ 144 = 0 (Common) When GPZ-BS10 is installed, 81 ~ 144 are available			✓
<b>10-55-01</b>	<b>Package Network Setup – IP Address</b> Define the IP Address for the GCD-ETIA. ➔ <i>When the blade is deleted from the system using Program 90-05, the programming for the slot in 10-55 is set back to default.</i>	0.0.0.0 ~ 126.255.255.254 128.0.0.1 ~ 191.255.255.254 192.0.0.1 ~ 223.255.255.254	172.16.1.100	✓		
<b>10-55-03</b>	<b>Package Network Setup – Main/Add-on</b> Set to 0 to distribute an IP Address to the blade.	0 = Main 1 = Add-on	1	✓		

Program Number	Program Name/Description	Input Data	Default	Level		
				1	2	3
10-55-04	<b>Package Network Setup – Sub Net Mask</b> Define the subnet mask for the GCD-ETIA.	128.0.0.0   192.0.0.0   224.0.0.0  240.0.0.0   248.0.0.0   252.0.0.0  254.0.0.0   255.0.0.0  255.128.0.0   255.192.0.0  255.224.0.0   255.240.0.0  255.248.0.0   255.252.0.0  255.254.0.0   255.255.0.0  255.255.128.0   255.255.192.0  255.255.224.0   255.255.240.0  255.255.248.0   255.255.252.0  255.255.254.0   255.255.255.0  255.255.255.128  255.255.255.192  255.255.255.224  255.255.255.240  255.255.255.248  255.255.255.252  255.255.255.254  255.255.255.255	255.255.0.0	✓		
10-55-05	<b>Package Network Setup – Default Gateway</b> Define the default gateway for the GCD-ETIA.	0.0.0.0 ~ 126.255.255.254 128.0.0.1 ~ 191.255.255.254 192.0.0.1 ~ 223.255.255.254	0.0.0.0	✓		
11-07-01	<b>Department Group Pilot Numbers – Dial</b> Assign a Department Group pilot number for the Voice Mail (maximum of eight digits). The extensions are assigned to the group in Program 16-02-01.	Maximum of eight digits.	No Setting	✓		
14-01-22	<b>Basic Trunk Data Setup – Caller ID to Voice Mail</b> Enable/Disable the system ability to send the Caller ID digits to voice mail.	Trunks 1 ~ 400 0 = Disable 1 = Enable	0	✓		
14-02-10	<b>Analog Trunk Data Setup – Caller ID</b> Enable/Disable a trunk user ability to receive Caller ID information.	Trunks 1 ~ 400 0 = No 1 = Yes	0	✓		
15-02-08	<b>Multiline Telephone Basic Data Setup – Automatic Handsfree</b> Set whether pressing a key accesses a One-Touch Key or preselects the key.	0 = Preselect 1 = One-Touch (Automatic Handsfree)	1		✓	
15-02-26	<b>Multiline Telephone Basic Data Setup – MSG Key Operation Mode</b> Determine whether an extension MSG key should function as a Message key or Voice Mail key. If set as a Message key, users can press the key to call the voice mail only when they have new messages.	0 = Message Key 1 = Voice Mail Key	0		✓	
15-02-28	<b>Multiline Telephone Basic Data Setup – Message Waiting Lamp Color</b> Determine whether an extension Message Waiting Lamp lights Green or Red when a message is received.	0 = Green 1 = Red	1		✓	

Program Number	Program Name/Description	Input Data	Default	Level		
				1	2	3
15-02-37	<b>Multiline Telephone Basic Data Setup – Voice Mail Message Wait Lamp Color</b> Set up various message wait lamp cycle options for lamp color.	0 = Green 1 = Red	1		✓	
15-02-38	<b>Multiline Telephone Basic Data Setup – Voice Mail Message Wait Lamp Cycle</b> Select the cycle method that the Large LED flashes when the extension has a VM Message Waiting set to the extension.	1 = Cycle 1 2 = Cycle 2 3 = Cycle 3 4 = Cycle 4 5 = Cycle 5 6 = Cycle 6 7 = Cycle 7	3		✓	
15-03-01	<b>Single Line Telephone Basic Data Setup – SLT Signaling Type</b> For each UNIVERGE SV9100 voice mail extension, set this option to 1.	0 = DP 1 = DTMF	1		✓	
15-03-03	<b>Single Line Telephone Basic Data Setup – Terminal Type</b> Enter 1 for this option to allow a single line port to receive DTMF tones after the initial call setup. Enter 0 to have the port ignore DTMF tones after the initial call setup. For Voice Mail, always enter 1 (e.g., receive DTMF tones).	0 = Normal 1 = Special	0	✓		
15-03-09	<b>Single Line Telephone Basic Data Setup – Caller ID Function - For External Module</b> Enable/Disable the Caller IFD FSK signal for an external Caller ID Module or a 3 <sup>rd</sup> -Party vendor telephone with Caller ID display. If voice mail is used, set this to 0 for the system integration code to be correct.	0 = Disable (Off) 1 = Enable (On)	0	✓		
15-07-01	<b>Programmable Function Keys</b> Assign a Voice Mail key to an extension. You must enter the Voice Mail key code (code 77) followed by: <ul style="list-style-type: none"> <li>○ Your own extension number if you are setting up your own Voice Mail key.</li> <li>○ A virtual extension number if you are setting up a Message Center key for a virtual extension.</li> <li>○ A co-worker's extension number if you are setting up a Message Center key for an installed extension.</li> <li>○ An uninstalled extension number if you are setting up a Message Center key for an uninstalled extension.</li> <li>○ (Optional) Assign a Voice Mail Record key to an extension (code 78).</li> <li>○ (Optional) Use a Call Redirect key (49) to allow a user to transfer a call to another extension or voice mail without answering the call.</li> </ul>	Line Key 1 ~ 48 0 ~ 99 (Normal Function Code 751 by default) *00 ~ *99 (Appearance Function Code) (Service Code 752 by default)	Refer to the Programming Manual for default values.		✓	

Program Number	Program Name/Description	Input Data	Default	Level		
				1	2	3
16-02-01	<p><b>Department Group Assignment for Extensions</b></p> <p>Set the Department Group called by the pilot number and the extension priority when a group is called.</p> <p>Call Pickup Groups are set up in 23-02.</p> <p>➡ <i>When setting up hunt group priorities the VM ports must be assigned as port 1 = priority 1, port 2 = priority 2 and so on. Failure to do this causes the VM to answer but no audio is heard.</i></p>	<p>Department Groups 1 ~ 64</p> <p>Priority 1 ~ 9999</p>	<p>Default = 1 extensions in Department Group 1 with priority in port order:</p> <p>Port 1 priority = 1</p> <p>Port 256 priority = 256</p>	✓		
20-02-09	<p><b>System Options for Multiline Telephones – Disconnect Supervision</b></p> <p>Enable/Disable disconnect supervision for the system trunks.</p>	<p>0 = Disable</p> <p>1 = Enable</p>	1			✓
20-06-01	<p><b>Class of Service for Extensions</b></p> <p>Assign a Class of Service (1 ~ 15) to the voice mail extensions. Use COS 14 for all time modes.</p>	<p>Day Night/Mode: 1 ~ 8</p> <p>Class of Service of Extensions (1 ~ 15)</p>	<p>Extension port 101 = Class 15</p> <p>All other extension port = Class 1</p>		✓	
20-09-02	<p><b>Class of Service Options (Incoming Call Service) – Caller ID Display</b></p> <p>Turn Off or On the Caller ID display at an extension.</p>	<p>0 = Off</p> <p>1 = On</p>	COS 1 ~ 15 = 0		✓	
20-11-01	<p><b>Class of Service Options (Hold/Transfer Service) – Call Forward All</b></p> <p>Turn Off or On an extension user ability to set Call Forward All.</p>	<p>0 = Off</p> <p>1 = On</p>	COS 1 ~ 15 = 1		✓	
20-11-02	<p><b>Class of Service Options (Hold/Transfer Service) – Call Forward When Busy</b></p> <p>Turn Off or On an extension user ability to set Call Forwarding when Busy.</p>	<p>0 = Off</p> <p>1 = On</p>	COS 1 ~ 15 = 1		✓	
20-11-03	<p><b>Class of Service Options (Hold/Transfer Service) – Call Forwarding When Unanswered</b></p> <p>Turn Off or On an extension user ability to set Call Forwarding when Unanswered.</p>	<p>0 = Off</p> <p>1 = On</p>	COS 1 ~ 15 = 0		✓	
20-11-04	<p><b>Class of Service Options (Hold/Transfer Service) – Call Forwarding (Both Ringing)</b></p> <p>Turn Off or On an extension user ability to set Call Forwarding with Both Ringing.</p>	<p>0 = Off</p> <p>1 = On</p>	COS 1 ~ 15 = 1		✓	
20-11-05	<p><b>Class of Service Options (Hold/Transfer Service) – Call Forwarding with Follow Me</b></p> <p>Turn Off or On an extension user ability to set Call Forwarding with Follow Me.</p>	<p>0 = Off</p> <p>1 = On</p>	COS 1 ~ 15 = 1		✓	

Program Number	Program Name/Description	Input Data	Default	Level		
				1	2	3
20-11-12	<b>Class of Service Options (Hold/Transfer Service) – Call Forwarding Off-Premise (External Call forwarding)</b> Turn Off or On an extension user ability to set up Call Forwarding Off-Premise at their extension. For voice mail, set this option to off.	0 = Off 1 = On	COS 1 ~ 15 = 0		✓	
20-13-01	<b>Class of Service Options (Supplementary Service) – Long Conversation Alarm</b> Turn Off or On the Warning Tone for Long Conversation (not for single line telephones).	0 = Off 1 = On	COS 1 ~ 15 = 0		✓	
20-13-05	<b>Class of Service Options (Supplementary Service) – Intercom Off-Hook Signaling</b> Turn Off or On an extension ability to send off-hook signals.	0 = Off 1 = On	COS 1 ~ 15 = 1		✓	
20-13-06	<b>Class of Service Options (Supplementary Service) – Automatic Off-Hook Signaling (Automatic Override)</b> Allow a busy extension to Manually (0) or Automatically (1) receive off-hook signals. ➤ <i>This setting is to receive incoming call signaling information during call queuing.</i>	0 = Off 1 = On	COS 1 ~ 15 = 1		✓	
20-13-07	<b>Class of Service Options (Supplementary Service) – Message Waiting</b> Turn Off or On an extension user ability to leave Message Waiting.	0 = Off 1 = On	COS 1 ~ 15 = 1		✓	
20-13-13	<b>Class of Service Options (Supplementary Service) – Continued Dialing (DTMF) Signal On ICM Call</b> Turn Off or On an extension user ability to use Continued Dialing, which allows DTMF signal sending while talking on extension.	0 = Off 1 = On	COS 1 ~ 15 = 1		✓	
20-13-15	<b>Class of Service Options (Supplementary Service) – Barge-In, Initiate</b> Turn Off or On an extension user ability to barge-in on other's calls.	0 = Off 1 = On	COS 1 ~ 15 = 0		✓	
20-13-16	<b>Class of Service Options (Supplementary Service) – Barge-In, Receive</b> Turn Off or On an extension user ability to have other extensions Barge-In on calls.	0 = Off 1 = On	COS 1 ~ 15 = 0		✓	
20-13-28	<b>Class of Service Options (Supplementary Service) – Allow Class of Service to be Changed</b> Turn Off or On an extension user ability to change COS via Service Code 677.	0 = Off 1 = On	COS 1 ~ 15 = 0		✓	

Program Number	Program Name/Description	Input Data	Default	Level		
				1	2	3
20-13-35	<p><b>Class of Service Options (Supplementary Service) – Block Camp On</b></p> <p>Turn Off or On an extension user ability to block callers from dialing to Camp -On. Set this option to 0 for voice mail.</p>	<p>0 = Off 1 = On</p>	COS 1 ~ 15 = 0		✓	
22-01-04	<p><b>System Options for Incoming Calls – DIL No Answer Recall Time</b></p> <p>A DIL that rings its programmed destination longer than this time diverts to the DIL No Answer Ring Group (set in Program 22-08).</p>	0 ~ 64800 seconds	0	✓		
24-02-02	<p><b>System Options for Transfer – MOH or Ring back on Transferred Calls</b></p> <p>Enable/Disable MOH on Transfer. If set to 0, a transferred caller hears Music on Hold while their call rings the destination extension. If set to 1, a transferred caller hears ring back while their call rings the destination extension. For this option to work with voice mail, the transferred call must be an unscreened transfer.</p>	<p>0 = Hold Tone 1 = Ring Back Tone</p>	0		✓	

**Assign Trunks As Automated Attendant Trunks – Method 1:**

Program Number	Program Name/Description	Input Data	Default	Level		
				1	2	3
22-02-01	<p><b>Incoming Call Trunk Setup</b></p> <p>Assign Service Type 4 to each trunk you want to ring into Voice Mail as a Direct Inward Line (DIL).</p>	<p>Trunks 1 ~ 400</p> <p>0 = Normal 1 = VRS (second dial tone if no VRS installed) 2 = DISA 3 = DID 4 = DIL 5 = E&amp;M Tie line 6 = Delayed VRS 7 = ANI/DNIS 8 = DID(DDI) Mode Switching</p>	0		✓	
22-07-01	<p><b>DIL Assignment</b></p> <p>Assign the destination extension or Department Calling Group for each DIL incoming trunk. A DIL rings an extension directly, without any other Access Map or Ring Group Programming. Use Program 22-02 to designate a DIL trunk. If all Voice Mail ports are in the same Extension (Department) Group, the DIL rings another Voice Mail port if its assigned port is busy.</p> <p>➡ For this selection to work, set Program 22-02-01 to 4 (DIL).</p>	<p>Day/Night Modes (1 ~ 8): Extension Number (maximum of eight digits) Pilot Number</p>	No Setting	✓		

**Assign Trunks As Automated Attendant Trunks – Method 2:**

Program Number	Program Name/Description	Input Data	Default	Level		
				1	2	3
22-02-01	<b>Incoming Call Trunk Setup</b> Assign 0 to each trunk you want to ring into Voice Mail as a normal line.	Trunks 1 ~ 400 0 = Normal 1 = VRS (second dial tone if no VRS installed) 2 = DISA 3 = DID 4 = DIL 5 = E&M Tie line 6 = Delayed VRS 7 = ANI/DNIS 8 = DID(DDI) Mode Switching	0		✓	
22-04-01	<b>Incoming Extension Ring Group Assignment</b> Assign Ring Group 102 for an In-Skin/External Voice Mail, or 103 for a Central Voice Mail as the destination.	Maximum of eight digits.	Extensions 101 ~ 108 (first eight ports) ring for incoming Ring Group 1 calls. No other extensions ring for incoming Ring Group 1 calls.		✓	

**For Either Method:**

Program Number	Program Name/Description	Input Data	Default	Level		
				1	2	3
11-12-42	<b>Service Code Setup (for Service Access) – Flash on Trunk Lines</b> Program the dial access code used for sending a hook flash to Telco. This code is used for Centrex Transfer using Digital Voice Mail ports. If this code starts with #, Program 45-01-05 must be set to 0.	SLT 0 ~ 9, *, # Maximum of eight digits	#3		✓	
22-04-01	<b>Incoming Extension Ring Group Assignment</b> Assign extensions to Ring Groups. Calls ring extensions according to Ring Group Programming To enable Voice Mail Overflow, assign selected extensions to a Ring Group that ring for unanswered DILs to Voice Mail ports. In Program 22-06, enter 1 to enable overflow ringing.	Maximum of eight digits.	Extensions 101 ~ 108 (first eight ports) ring for incoming Ring Group 1 calls. No other extensions ring for incoming Ring Group 1 calls.		✓	



Program Number	Program Name/Description	Input Data	Default	Level		
				1	2	3
22-08-01	<b>DIL/IRG No Answer Destination</b> For Voice Mail Overflow, enter the Ring Group that unanswered DILs to Voice Mail ring after the DIL Call Waiting time expires (Program 22-01-04).	0 = (No Setting) 001 ~ 100 = Incoming Ring Group 102 = (In-Skin/ External Voice Mail or InMail)	0		✓	
24-02-03	<b>System Options for Transfer – Delayed Call Forwarding Time</b> If activated at an extension, Delayed Call Forwarding occurs after this time This also sets the time a Transferred call waits at an extension forwarded to voice mail before routing to the called extension mailbox.	0 ~ 64800 seconds	10		✓	
45-01-01	<b>Voice Mail Integration Options – Voice Mail Department Group Number</b> Assign which Extension (Department) Group number is to be assigned as the voice mail group. This program defines the Quick Transfer to Voice Mail destination. A 0 entry means no voice mail is installed.	0 ~ 64 0 = No Voice Mail	0	✓		
45-01-02	<b>Voice Mail Integration Options – Voice Mail Master Name</b> Enter the Voice Mail master name.	Maximum of 12 characters.	Voice Mail		✓	
45-01-04	<b>Voice Mail Integration Options – Park and Page</b> Enable/Disable the system ability to process the Voice Mail Park and Page (*) commands. You should normally enable this option.	0 = Off 1 = On	1	✓		
45-01-05	<b>Voice Mail Integration Options – Message Wait</b> Enable/Disable the system ability to process the Voice Mail Message Wait (#) commands. You should normally enable this option. If enabled be sure the Programmed Message notification strings do not contain the code for trunk access. When using Centrex transfer from a voice mail port the following items must be considered: ○ If the Feature Access Code starts with # in Program 11-12-42 set Program 45-01-05 to 0. ○ When assigning the dial string in voice mail, one or more “Pauses” may be needed too, depending on what Telco needs.	0 = Off 1 = On	1		✓	
45-01-06	<b>Voice Mail Integration Options – Record Alert Tone Interval Time</b> Set the time between Voice Mail Conversation Record alerts.	0 ~ 64800 seconds	30		✓	

Program Number	Program Name/Description	Input Data	Default	Level		
				1	2	3
45-01-18	<b>Voice Mail Integration Options – Trunk Number Mapping</b> Assign the digits of trunk number mapping.	2 ~ 3	2		✓	
80-01-02	<b>Service Tone Setup – Basic Tone Number</b> Customize the systems service tones.	0 ~ 33 0 = No Tone 33 = Default Time Slot	Refer to the Programming Manual for default values.		✓	
80-03-01	<b>DTMF Tone Receiver Setup – Detect Level</b> Customize the Detect Level for DTMF Tone Receivers.	0 = 0dBm ~ -25dBm 1 = -5dBm ~ -30dBm 2 = -10dBm ~ -35dBm 3 = -15dBm ~ -40dBm 4 = -20dBm ~ -45dBm 5 = -25dBm ~ -50dBm 6 = -30dBm ~ -55dBm	Type 1 ~ 5 = 0			✓
80-03-02	<b>DTMF Tone Receiver Setup – Start Delay Time</b> Define the start delay time for DTMF Tone Receiver.	0 ~ 255 (0.25ms ~ 64ms)	Type 1 ~ 5 = 0		✓	

Program Number	Program Name/Description	Input Data	Default	Level		
				1	2	3
80-03-03	<b>DTMF Tone Receiver Setup – Min. Detect Level</b> Define the minimum detection level for DTMF Tone Receiver.	0 ~ 15 detect level 0: -10dBm(0) to -25dBm(15) detect level 1: -15dBm(0) to -30dBm(15) detect level 2: -20dBm(0) to -35dBm(15) detect level 3: -25dBm(0) to -40dBm(15) detect level 4: -30dBm(0) to -45dBm(15) detect level 5: -35dBm(0) to -50dBm(15) detect level 6: -40dBm(0) to -55dBm(15) detect level 7: -45dBm(0) to -60dBm(15) detect level 8: -50dBm(0) to -65dBm(15) detect level 9: -55dBm(0) to -70dBm(15) detect level 10: -60dBm(0) to -75dBm(15) detect level 11: -65dBm(0) to -80dBm(15) detect level 12: -70dBm(0) to -85dBm(15) detect level 13: -75dBm(0) to -90dBm(15) detect level 14: -80dBm(0) to -95dBm(15) detect level 15: -85dBm(0) to -100dBm(15)	Type 1 = 10 (-20dBm) Type 2 ~ 3 = 15 (-25dBm) Type 4 ~ 5 = 10 (-20dBm)		✓	

Program Number	Program Name/Description	Input Data	Default	Level		
				1	2	3
80-03-04	<b>DTMF Tone Receiver Setup – Max. Detect Level</b> Define the maximum detection level for DTMF Tone Receiver.	0 ~ 15 detect level 0: 0dBm(0) to -15dBm(15) detect level 1: -5dBm(0) to -20dBm(15) detect level 2: -10dBm(0) to -25dBm(15) detect level 3: -15dBm(0) to -30dBm(15) detect level 4: -20dBm(0) to -35dBm(15) detect level 5: -25dBm(0) to -40dBm(15) detect level 6: -30dBm(0) to -45dBm(15) detect level 7: -35dBm(0) to -50dBm(15) detect level 8: -40dBm(0) to -55dBm(15) detect level 9: -45dBm(0) to -60dBm(15) detect level 10: -50dBm(0) to -65dBm(15) detect level 11: -55dBm(0) to -70dBm(15) detect level 12: -60dBm(0) to -75dBm(15) detect level 13: -65dBm(0) to -80dBm(15) detect level 14: -70dBm(0) to -85dBm(15) detect level 15: -75dBm(0) to -90dBm(15)	Type 1 ~ 5 = 2 (-2dBm)		✓	
80-03-05	<b>DTMF Tone Receiver Setup – Forward Twist Level</b> Define the forward twist level for DTMF Tone Receiver.	0 ~ 9 (1dB ~ 10dB)	Type 1 ~ 5 = 5 (6dBm)		✓	
80-03-06	<b>DTMF Tone Receiver Setup – Backward Twist Level</b> Define the backwards twist level for DTMF Tone Receiver.	0 ~ 9 (1dB ~ 10dB)	Type 1 ~ 5 = 0 (1dBm)		✓	
80-03-07	<b>DTMF Tone Receiver Setup – ON Detect Time</b> Define the On detection time for DTMF Tone Receiver.	1 ~ 255 (15+ 15ms ~ 3825ms)	<b>Version 1000</b> Type 1 ~ 5 = 1 (30ms)  <b>Version 3000 or higher</b> Type 1 ~ 5 = 3 (60ms)		✓	

Program Number	Program Name/Description	Input Data	Default	Level		
				1	2	3
80-03-08	<b>DTMF Tone Receiver Setup – OFF Detect Time</b> Define the Off detection time for DTMF Tone Receiver.	1 ~ 255 (15+ 15ms ~ 3825ms)	<b>Version 1000</b> Type 1 ~ 5 = 1 (30ms)		✓	
			<b>Version 3000 or higher</b> Type 1 ~ 5 = 2 (45ms)			
80-04-01	<b>Call Progress Tone Detector Setup – Detection Level</b> Define the various levels and timers for the Call Progress Tone Detector. ➡ <i>Use this option to set the Detection Level.</i>	0 = 0dBm ~ -25dBm 1 = -5dBm ~ -30dBm 2 = -10dBm ~ -35dBm 3 = -15dBm ~ -40dBm 4 = -20dBm ~ -45dBm 5 = -25dBm ~ -50dBm 6 = -30dBm ~ -55dBm	Type 1 (DT) = 0 (-25dBm) Type 2 (BT) = 0 (-25dBm) Type 3 (RBT) = 0 (-25dBm) Type 4, Type 5 = 0			✓
80-04-02	<b>Call Progress Tone Detector Setup – Min. Detection Level</b> Define the various levels and timers for the Call Progress Tone Detector. ➡ <i>Use this option to set the minimum detection level.</i>	0 ~ 15 detect level 0: -15dBm (0) to -30dBm(15) detect level 1: -30dBm (0) to -45dBm(15) detect level 2: -40dBm (0) to -55dBm(15)	<b>Version 1000</b> Type 1 (DT) – 15 (-25dBm) Type 2 (BT) – 15 (-25dBm) Type 3 (RBT) – 15 (-25dBm) Type 4, Type 5 – 0		✓	
			<b>Version 3000 or higher</b> Type 1 (DT) – 15 (-25dBm) Type 2 (BT) – 15 (-25dBm) Type 3 (RBT) – 15 (-25dBm) Type 4 – 0 Type 5 – 1			
80-04-03	<b>Call Progress Tone Detector Setup – S/N Ratio</b> Define the various levels and timers for the Call Progress Tone Detector.	0 ~ 4 (0dB ~ -20dB)	Type 1 (DT) = 4 (-20dB) Type 2 (BT) = 4 (-20dB) Type 3 (RBT) = 4 (-20dB) Type 4, Type 5 = 0		✓	

Program Number	Program Name/Description	Input Data	Default	Level		
				1	2	3
80-04-04	<p><b>Call Progress Tone Detector Setup – No Tone Time</b></p> <p>Define the various levels and timers for the Call Progress Tone Detector.</p> <p>➡ Use this option to set No Tone Time.</p>	<p>0 ~ 255 (30 + 30 ~ 7680ms) (0 = not detect)</p> <p>1 ~ 255 = 60 ~ 7680ms</p> <p>The formula is 30 + 30N.</p> <p>When set to N = 1, it means 30 + 30 * 1 = 60.</p> <p>When set to N=255, it means 30+30*255=7680</p>	<p>Type 1 (DT) – 132 (3990ms)</p> <p>Type 2 (BT) – 132 (3990ms)</p> <p>Type 3 (RBT) – 132 (3990ms)</p> <p>Type 4, Type 5 – 0</p>		✓	
80-04-05	<p><b>Call Progress Tone Detector Setup – Pulse Count</b></p> <p>Define the various levels and timers for the Call Progress Tone Detector.</p> <p>➡ Use this option to set the Pulse Count.</p>	1 ~ 255	<p>Type 1 (DT) = 1</p> <p>Type 2 (BT) = 1</p> <p>Type 3 (RBT) = 1</p> <p>Type 4, Type 5 = 0</p>		✓	
80-04-06	<p><b>Call Progress Tone Detector Setup – ON Minimum Time</b></p> <p>Define the various levels and times for the Call Progress Tone Detector.</p> <p>➡ Use this option to set the minimum On time.</p>	1 ~ 255 (30 + 30 ~ 7680ms)	<p><b>Version 1000</b></p> <p>Type 1 (DT) – 9 (300ms)</p> <p>Type 2 (BT) – 12 (300ms)</p> <p>Type 3 (RBT) – 25 (780ms)</p> <p>Type 4, Type 5 – 0</p>		✓	
			<p><b>Version 3000 or higher</b></p> <p>Type 1 (DT) – 45 (300ms)</p> <p>Type 2 (BT) – 12 (300ms)</p> <p>Type 3 (RBT) – 25 (780ms)</p> <p>Type 4 – 0</p> <p>Type 5 – 5</p>			
80-04-07	<p><b>Call Progress Tone Detector Setup – ON Maximum Time</b></p> <p>Define the various levels and times for the Call Progress Tone Detector.</p> <p>➡ Use this option to set the maximum On time.</p>	0 ~ 255 (30+30 ~ 7680ms)	<p><b>Version 1000</b></p> <p>Type 1 (DT) – 0</p> <p>Type 2 (BT) – 20 (630ms) [ET]</p> <p>Type 3 (RBT) – 40 1230ms)</p> <p>Type 4, Type 5 – 0</p>		✓	
			<p><b>Version 3000 or higher</b></p> <p>Type 1 (DT) – 0</p> <p>Type 2 (BT) – 20 (630ms) [ET]</p> <p>Type 3 (RBT) – 40 1230ms)</p> <p>Type 4 – 0</p> <p>Type 5 – 15</p>			

Program Number	Program Name/Description	Input Data	Default	Level		
				1	2	3
80-04-08	<b>Call Progress Tone Detector Setup – OFF Minimum Time</b> Define the various levels and times for the Call Progress Tone Detector. ➔ Use this option to set the minimum Off time.	1 ~ 255 (30+30 ~ 7680ms)	Type 1 (DT) = 1 (60ms) Type 2 (BT) = 12 (300ms) Type 3 (RBT) = 83 (2520ms) Type 4, Type 5 = 0		✓	
80-04-09	<b>Call Progress Tone Detector Setup – OFF Maximum Time</b> Define the various levels and times for the Call Progress Tone Detector. ➔ Use this option to set the maximum Off time.	0 ~ 255 (30+30 ~ 7680ms)	Type 1 (DT) = 1 (60ms) Type 2 (BT) = 20 (450ms) Type 3 (RBT) = 115 (3480ms) Type 4, Type 5 = 0		✓	

## Operation

Refer to UM800 Mail User Guide for complete telephone operation procedures.

## *uMobility – Wi-Fi Client*

### Description

The uMobility Wi-Fi Client functions as a Standard SIP station on Blackberry®, iPhone and Android™ smart phones. The uMobility Wi-Fi Client allows the user to:

- Answer incoming calls to the office telephone system directly from your smart phone.
- Make calls from the smart phone that uses your office telephone system's default number.
- Hold and Transfer calls to other stations in the telephone system.
- Talk on the smart phone and not use any cellular network minutes when using the uMobility Wi-Fi Client in a Wi-Fi hotspot at the office, at home or at a public hotspot.
- Access work voice mail directly from your smart phone.

Refer to the Feature Support Table for a complete list of supported system features.

### Enhancements

- Answer calls during lock mode on iPhone.
- G.729 is now supported.
- iOS8 is now supported.

### Conditions

- Transferring a call to a Remote Conference from a uMobility extension is not supported.
- The SV9100 supports the NAT (Network Address Translation) mode for Standard SIP terminals. This will allow the uMobility client to connect via NAT. This feature has been optimized when connecting via 4G/Wi-Fi.
- Voice quality is dependent on the network infrastructure when in the Wi-Fi domain. As such, voice quality can vary between locations.
- The maximum number of uMobility Wi-Fi Client devices that can be supported is dictated by the GPZ-IPLE and the number of desk IP Phones already in the system.
- The setting in Program 99-01-60 affects SIP messages when using the Call Forward with Both Ring feature (Twinning). For the uMobility and Desk phone to work together properly, this must be set to 1 (On). The default is 0 (Off).
- When using voice mail the following conditions apply to all client devices:
  - The uMobility feature can be used with UM8000 InMail.
  - The uMobility feature can be used with VM8000 InMail.
  - The uMobility feature cannot be used with UCB (Unified Communications for Business).



- For Call Forwarding the following conditions apply to all client devices:
  - Call Forwarding with Both Ring is used for Twinning to have calls directed to the desk phone ring at both the desk phone and the uMobility client phone. To get callers to voice mail, the uMobility client phone should then be forwarded BNA to voice mail. The caller goes to the mailbox of the desk phone. Refer to Call Forward with Both Ring for more information.
  - When using Call Forward Both Ring, when a uMobility device is on a call, a second call to that device does not follow forwarding.
  - Call Forward with Both Ring is not supported across K-CCIS networks. Therefore, the desk phone and the uMobility Wi-Fi Client device must be in the same phone system.
  - The UCB (Unified Communications for Business) feature cannot be used with Call Forward Both Ring. Therefore, the uMobility client phone cannot be used with UCB.
  - When using Call Forward with Both Ring, the voice mail should be configured so the Message Waiting Indication is provided for desk phone.
  - If an extension has Call Forward with Both Ring set to another extension, it will only continue to forward if the Both Ring destination is forwarded (B/NA or NA) to VM only.
  - For uMobility client devices to utilize dial access codes for system features the dial access codes must be all numbers and cannot contain \* or #.
- Internal calls from an uMobility mobile device displays the station name as assigned in Program15-01-01 not on the uMobility telephone.
- Emergency calls (911 and E911) from uMobility client devices should not be routed through the uMobility or SV9100 system and are not supported.
- Caller ID information for inbound trunks calls is only provided if the following conditions are met:
  - The inbound call is on a trunk that provides CID.
  - The inbound trunk is set to 0 (Wait for CID) in Program 14-02-23.
  - The inbound calls are directed using the DID, DIL or Ring Group assignment to the uMobility client, transferred calls will not show CID information.
- NEC recommends Call Forwarding for the uMobility client be set by the SV9100 Administrator, instead of at the device. Call Forwarding can be set up by access code, but a confirmation tone is not available.
- uMobility WiFi client supports G.711 and G.729 Codecs with 20ms or 40ms payload/packetization time.
- On Blackberry, a missed call notification is provided only as an audible notification. It does not provide a visual pop up notification like iPhone and Android phones.
- When the uMobility client connects via NAT, Program 15-05-47 must be set to 60 seconds for that extension.

## Limitations



CAUTION

### ***NON-AVAILABILITY of TRADITIONAL EMERGENCY ACCESS SERVICES (EAS)***

*The software does not support traditional EAS, for example 911 or E911 in the US or 999 in the UK. Therefore, the user must route emergency calls through the cellular network rather than Voice over IP (VoIP) facilities. The user of the software and any such parties shall inform all users, guests and other third persons, who may or may not be present at the physical location where you utilize the service, of the non-availability of traditional EAS in all circumstances through the software. The user of the software must understand the limitation and plan for EAS while using the software in their country, while roaming in different countries, using other networks, and other such locations either with or without provision for EAS services.*

- Depending on Android device, bluetooth® functionality might not function properly. For example, switching audio from device audio to bluetooth device etc. NEC is not responsible for bluetooth/device connectivity issues.
- Due to OS Limitations, QoS value of uMobility may differ depending on OS:
  - iPhone/iPad: SIP packet: Fixed CS5, RTP packet: Configurable on uMobility setting.
  - Android: SIP packet: Fixed Default(0x00), RTP packet: Configurable on uMobility setting.
  - Blackberry: SIP and RTP packet: Fixed Default (0x00).

## Required Settings for Remote SIP Access

For a remote SIP connection from outside to inside the SIP server, it is necessary to consider "NAT" for SIP. The diagrams below show typical scenarios when connecting SIP soft phones remotely from outside.

Figure 2-98 VPN Between Smart Device and Office LAN

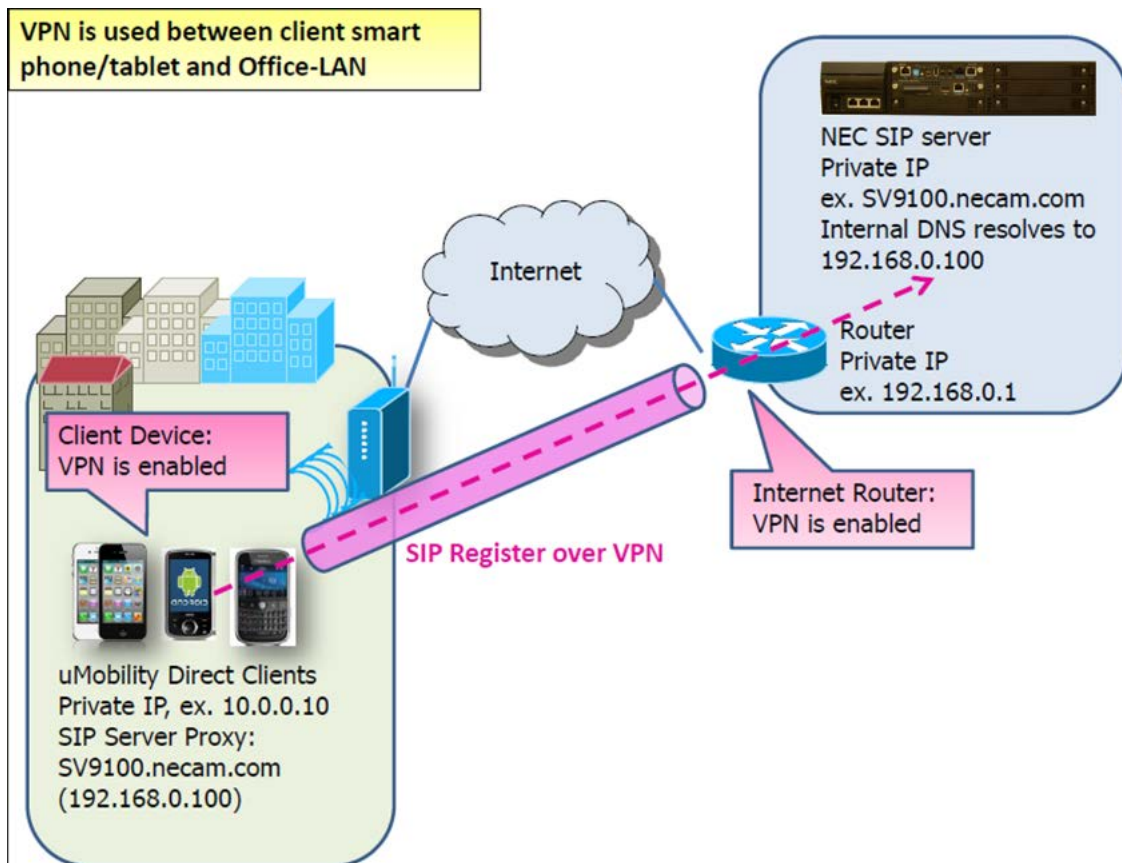

Figure 2-99 Port Forwarding without Session Border Controller

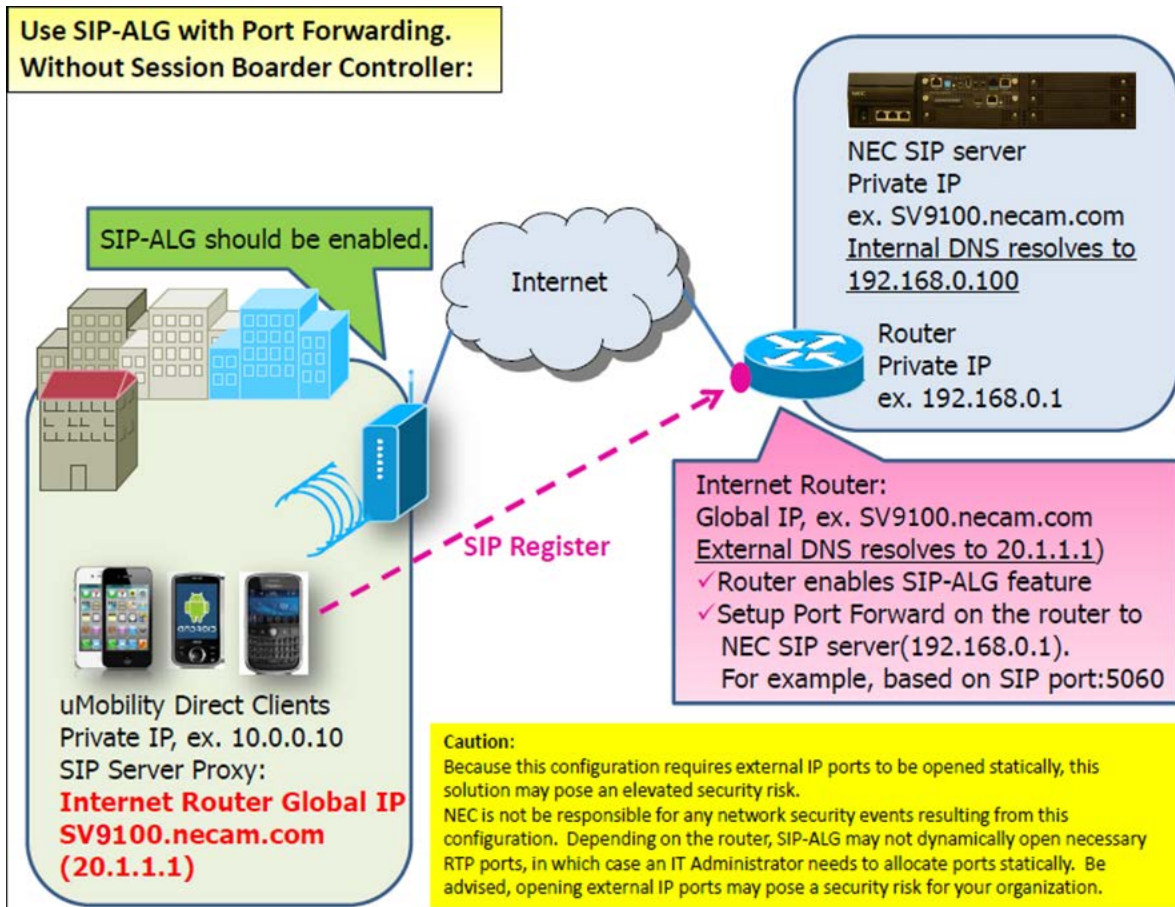
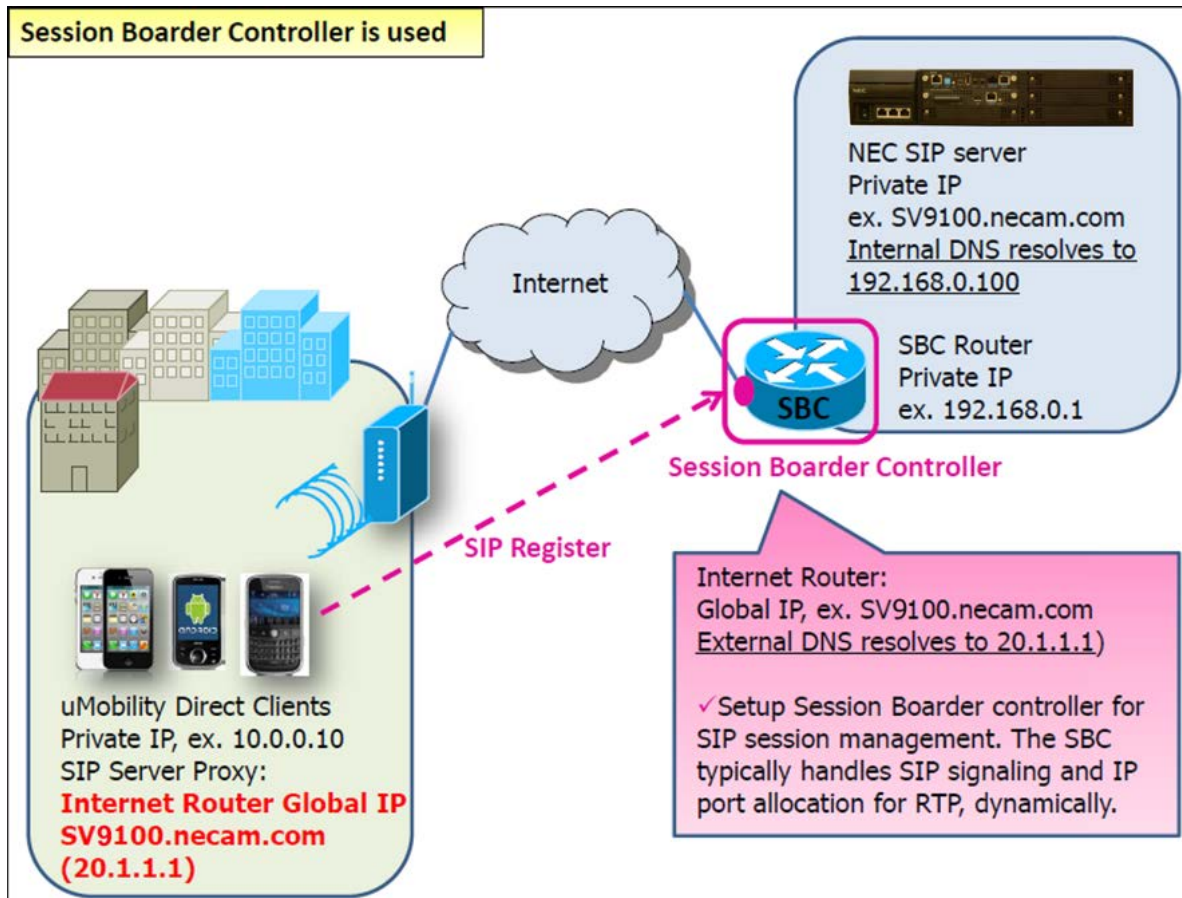

Figure 2-100 Port Forwarding with Session Boarder Controller



### Default Settings

Disabled

## System Availability

### Terminals

Table 2-137 Error Messages and Causes

Device	Required OS	Tested Device
iPhone	Version 5.5.1 or higher	iPhone 3GS iPhone 4 iPhone 4S iPhone 5 See Note 1
Android phone	Version 2.3.0 or higher	Motorola MB865 LG Nitro HD Samsung Galaxy SII See Note 2
Blackberry phone	Version 7 or higher	Blackberry Bold 9900

Note 1: The iPhone 4S sleep mode shuts down Wi-Fi, uMobility cannot be used when the iPhone 4S is in sleep mode.

Note 2: NEC uMobility may function without problems on Android devices not listed above.

### Required Component(s)

- **Version 1.80.00 or higher** software and appropriate licenses
- Third Party SIP License for each uMobility Wi-Fi Client
- GPZ-IPLE
- Available SIP station ports

### Related Features

- ➔ **Call Forwarding**
- ➔ **IP Single Line Telephone (SIP)**
- ➔ **UM8000 Mail**

Table 2-138 Supported System Feature List

Feature Name/Description	
<b>Basic Telephony (PBX/CM Dependent)</b>	<b>NEC SV9100</b>
<b>Enterprise Dialing (ED)</b>	
Call Forward All (CFA)	Yes
Call Forward Busy (CFB)	Yes
Call Forward No Answer (CFNA)	Yes
Call Hold and Resume	Yes
Call Waiting	No
Conference Call	Yes (Participant Only)
Calling Line Identification (Calling Name)	Yes
Abbreviated extension dialing	Yes
Mid-call DTMF ➤ <i>Numeric keys, excluding * and #.</i>	Yes
<b>Basic Telephony (Device Dependent)</b>	
Speed Dial	No
Missed Call Indication	Yes
Call Logs	Yes
Contact Dialing	Yes
Mute/Unmute	Yes
Speakerphone	Yes
Volume Control	Yes
Do Not Disturb (DND)	Yes
Bluetooth	Yes (See Conditions)
<b>Presentation (PBX/CM Dependent)</b>	
Blind Call Transfer	Yes
Supervised Call Transfer	Yes
<b>Voicemail</b>	
Message Waiting Indicator (MWI)	Yes



## Guide to Feature Programming

The **Level 1**, **Level 2** and **Level 3** columns indicate the programs that are assigned when programming this feature in the order they are most commonly used. These levels are used with PCPro and WebPro wizards for feature programming.

- Level 1 – these are the most commonly assigned programs for this feature.
- Level 2 – these are the next most commonly assigned programs for this feature.
- Level 3 – these programs are not often assigned and require an expert level working knowledge of the system to be properly assigned.

Program Number	Program Name/Description	Input Data	Default	Level		
				1	2	3
10-12-01	<b>GCD-CP10 Network Setup – IP Address</b> If required, change the IP Address so it does not conflict with Program 10-12-09.	0.0.0.0 ~ 126.255.255.254 128.0.0.1 ~ 191.255.255.254 192.0.0.1 ~ 223.255.255.254	192.168.0.10	✓		
10-12-03	<b>GCD-CP10 Network Setup – Default Gateway</b> Assign the default gateway IP address for the GCD-CP10.	0.0.0.0 ~ 126.255.255.254 128.0.0.1 ~ 191.255.255.254 192.0.0.1 ~ 223.255.255.254	0.0.0.0	✓		
10-12-04	<b>GCD-CP10 Network Setup – Time Zone</b> Set correct time zone for system.	0~24 (0 = -12 Hours and 24 = +12 Hours)	Eastern Time Zone		✓	
10-12-09	<b>GCD-CP10 Network Setup – IP Address</b> Set IP address for GPZ-IPLC.	0.0.0.0 ~ 126.255.255.254 128.0.0.1 ~ 191.255.255.254 192.0.0.1 ~ 223.255.255.254	172.16.0.10	✓		
10-12-10	<b>GCD-CP10 Network Setup – Subnet Mask</b> Define the Media Gateway Subnet Mask Address.	128.0.0.0   192.0.0.0   224.0.0.0  240.0.0.0   248.0.0.0   252.0.0.0  254.0.0.0   255.0.0.0  255.128.0.0   255.192.0.0  255.224.0.0   255.240.0.0  255.248.0.0   255.252.0.0  255.254.0.0   255.255.0.0  255.255.128.0   255.255.192.0  255.255.224.0   255.255.240.0  255.255.248.0   255.255.252.0  255.255.254.0   255.255.255.0  255.255.255.128  255.255.255.192  255.255.255.224  255.255.255.240  255.255.255.248  255.255.255.252  255.255.255.254  255.255.255.255	255.255.0.0		✓	



Program Number	Program Name/Description	Input Data	Default	Level		
				1	2	3
10-33-02	<p><b>SIP Registrar/Proxy Information Basic Setup – Authentication Mode</b></p> <p>Enable if a password is desired for the uMobility clients to register. When checked, Program 15-05-16 must have a password entered and the uMobility client must have the same password configured. When using Authentication, the station number is the authorization name.</p>	<p>0 = Disable 1 = Enable</p>	0		✓	
10-33-05	<p><b>SIP Registrar/Proxy Information Basic Setup – NAT Mode</b></p> <p>When system controls remote SIP phone via NAT router, set this program to 1 = Enable.</p>	<p>0 = Disable 1 = Enable</p>	0	✓		
11-12-29	<p><b>Service Code Setup (for Service Access) – Direct Extension Call Pickup</b></p> <p>Customize the Service Codes for direct extension call pickup.</p> <p>➔ <i>For the Direct Call Pickup feature to work on all mobile devices the access code in Program 11-12-29 must be changed from ** to an all number access code, for example 758.</i></p>	<p>MLT, SLT 0 ~ 9, *, # Maximum of eight digits</p>	**		✓	
14-02-23	<p><b>Analog Trunk Data Setup – Caller ID Receiving Method</b></p> <p>Rings extension before receiving Caller ID (1) or after receiving Caller ID (0).</p> <p>➔ <i>If Caller ID is received on a trunk that is in the same ring group as a uMobility client device this should be set to 0 (Wait Caller ID).</i></p>	<p>0 = Wait Caller ID 1 = Immediate Ring</p>	1		✓	
15-05-04	<p><b>IP Telephone Terminal Basic Data Setup – Nickname</b></p> <p>Assign nick name to all system phones. This is the name displayed on internal calls to a uMobility client device.</p>	Maximum of 48 characters.	No Setting		✓	
15-05-16	<p><b>IP Telephone Terminal Basic Data Setup – Authentication Password</b></p> <p>Assign the authentication password for SIP single line telephones.</p> <p>➔ <i>If using authentication for the uMobility Client devices the password should be entered here.</i></p>	Maximum of 24 characters.	No Setting		✓	

Program Number	Program Name/Description	Input Data	Default	Level		
				1	2	3
15-05-45	<p><b>IP Telephone Terminal Basic Data Setup – NAT Plug and Play</b></p> <p>This program is valid when Program 10-46-14 is On (NAT feature activated).</p> <p>Select sending RTP port number to remote Router, use from negotiation result (0) or received RTP packet (1).</p> <p>SV9100 uses this program to decide a destination port of RTP transmitting packets from IPLE to a remote IP terminal. If “0:OFF” is selected, the destination port of RTP transmitting packets will be a SIP/SDP negotiation result.(same behavior as before). If you chose “1:ON”, the destination port of RTP transmitting packet will be the same port of a source port of a receiving RTP packet on IPLE.</p>	<p>0 = Disable</p> <p>1 = Enable</p>	0	✓		
24-02-03	<p><b>System Options for Transfer – Delayed Call Forwarding Time</b></p> <p>Set the Delayed Call Forwarding interval. For an unanswered call, Call Forward No Answer occurs after this interval.</p> <p>➡ <i>Set Call Forward No Answer time to 30 seconds or more for uMobility phones. This will give them time to ring when they are in the cellular domain.</i></p>	0 ~ 64800 seconds	10	✓		
24-02-04	<p><b>System Options for Transfer – Transfer Recall Time</b></p> <p>Set the Transfer Recall Time. An unanswered transferred call recalls to the extension that initially transferred it after this time. This also sets the time a transferred call camps-on to a busy extension.</p> <p>➡ <i>Set Transfer Recall Time at least 5 seconds longer than Delayed Call Forward Time (Program 24-02-03) for uMobility phones.</i></p>	0 ~ 64800 seconds	30	✓		
24-09-01	<p><b>Combined Paging Assignments</b></p> <p>Assign Call Forwarding Type and the destination numbers for each extension/virtual extension.</p> <p>➡ <i>Set all uMobility client phones to forward BNA (4).</i></p>	<p>0 = Call Forwarding Off</p> <p>1 = Call Forwarding with both ring</p> <p>2 = Call Forwarding when no answer</p> <p>3 = Call Forwarding all calls</p> <p>4 = Call Forwarding busy or no answer</p> <p>5 = Call Forwarding when busy</p>	0	✓		
24-09-02	<p><b>Call Forward Split Settings – CO Call Forwarding Destination for Both Ring, All Call, No Answer</b></p> <p>Assign CO Call Forwarding Destination for ring, all call and no answer.</p> <p>➡ <i>Set all uMobility client phones to forward BNA to SV9100 voice mail.</i></p>	<p>Maximum of 24 digits (0 ~ 9, *, #, @, P, R)</p> <p>@ = Wait for Answer</p> <p>Supervision - ISDN trunks only</p> <p>P = Pause - Analog Trunk Only</p> <p>R = Hook flash - Analog Trunk Only</p>	No Setting	✓		

Program Number	Program Name/Description	Input Data	Default	Level		
				1	2	3
24-09-03	<p><b>Call Forward Split Settings – Interim Call Forwarding Destination for Both Ring, All Call, No Answer</b></p> <p>Assign Intercom Call Forwarding Destination for ring, all call and no answer.</p> <p>➔ <i>Set all uMobility client phones to forward BNA to SV9100 voice mail.</i></p>	<p>Maximum of 24 digits (0 ~ 9, *, #, @, P, R)</p> <p>@ = Wait for Answer Supervision - ISDN trunks only</p> <p>P = Pause - Analog Trunk Only</p> <p>R = Hook flash - Analog Trunk Only</p>	No Setting	✓		
84-20-01	<p><b>SIP Extension Basic Information Setup – Registrar/Proxy Port</b></p> <p>Define SIP station Proxy Port.</p>	1 ~ 65535	5070		✓	
84-26-01	<p><b>IPL Basic Setup – IP Address</b></p> <p>Assign the IP address for the DSP on the GPZ-IPLE.</p>	xxx.xxx.xxx.xxx	Slot 1 = 172.16.0.20	✓		
99-01-60	<p><b>Options 60</b></p> <p>This setting affects SIP messages when using the Call Forward with Both Ring feature. For the uMobility and Desk phone to work properly this must be set to 1 (On).</p>	<p>0 = Off</p> <p>1 = On</p>	0	✓		

## Operation

None

## Unicast/Multicast Paging Mode

### Description

With SV9100 software the IP terminals (DT700/DT800 series) can receive an Internal Page via a Unicast or Multicast packet based upon system programming. This feature allows IP terminals (DT700/DT800 series) to be assigned to Unicast Mode, Multicast Mode, or Auto.

When the phone is set to **Unicast Mode** the internal paging is sent to the phone via a Unicast Packet.

When the phone is set to **Multicast Mode** the internal page is sent to the phone via a Multicast Packet.

When the phone is set to Auto, the internal page is sent to the phone either by Multicast or Unicast based on the subnet of the IP station. If the DT700/DT800 series terminal is in the same subnet as the GPZ-IPLE then it will receive the Internal Page via a Multicast Packet. If the DT700/DT800 series terminal is in a different subnet than the GPZ-IPLE the DT700/DT800 series will receive the Internal Page via a Unicast Packet.

When phones are set to receive Unicast packets the GPZ-IPLE will send a separate RTP stream to each phone that is set to receive the page. E.g. If there are five DT700/DT800 series IP phones in the page group and they are all set to Unicast Page Mode the GPZ-IPLE will send five separate RTP streams utilizing five DSP resources.

When the phones are set to receive Multicast packets the GPZ-IPLE will send one RTP stream. Multicast is a protocol that allows one device to communicate to multiple devices without the need to stream to the individual end point. E.g. If there are five DT700/DT800 series IP phones in the page group that are set to Multicast Mode, the GPZ-IPLE will send one RTP stream utilizing only one DSP resource.

Figure 2-101 Multicast Mode Example

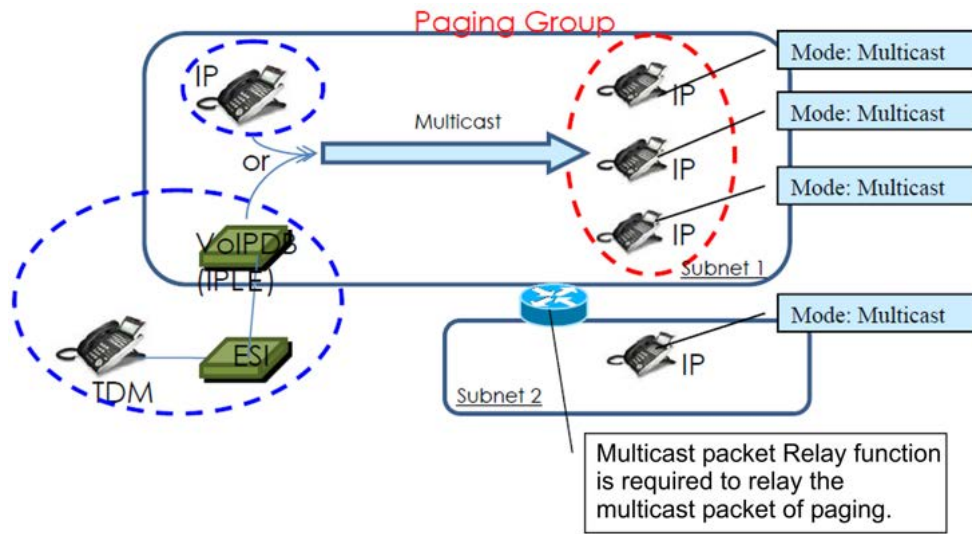

Figure 2-102 Unicast Mode Example

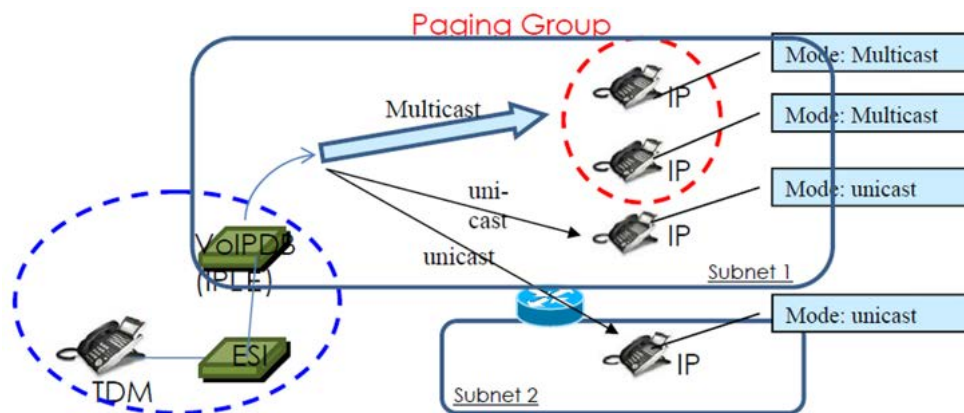
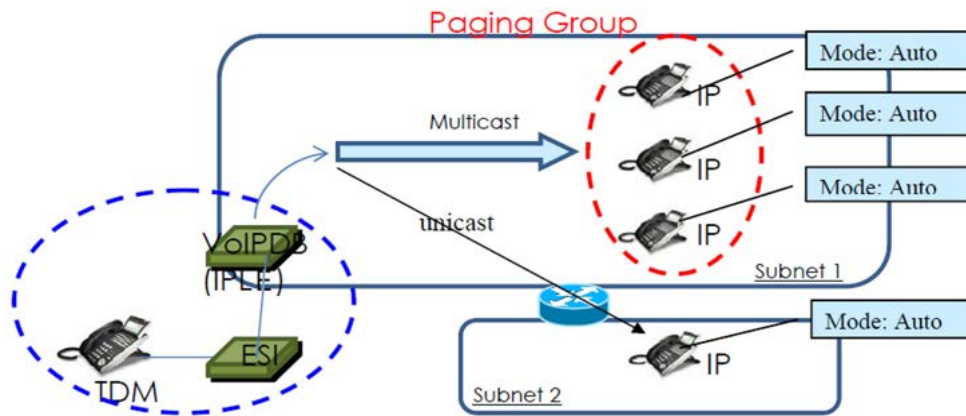

Figure 2-103 Auto Mode Example



- *By default routers do not pass Multicast packets between subnets. If you have IP phones in different subnets than the GPZ-IPLE, and you are trying to utilize Multicast paging, you have to program the router to pass the Multicast packet. Routing of Multicast Packets is not a default routing feature and should be confirmed with the manufacturer of the routing equipment.*
- *The default multicast address utilized by the SV9100 is 224.0.0.10. It should be noted that many routing devices available do not support multicast within the range of 224.0.0.0/24 and may require the default address to be changed in the SV9100.*

## GPZ-IPLE DSP Resource Selection

Three additional GPZ-IPLE DSP resource assignments are available. The new assignments are: **Common without Unicast Paging**, **Multicast Paging**, and **Unicast Paging**. The new assignments assist with keeping IP phones from using all available DSP resources when utilizing Unicast Paging.

When the DSP resource is set to **Common without Unicast Paging** the resource can be accessed by anything but a Unicast page.

When the DSP resource is set to **Multicast Paging** the resource can only be accessed by a Multicast page no other device/feature can access this resource.

When the DSP resource is set to **Unicast Paging** the resource can only be accessed by a Unicast page no other device/feature can access this resource.

### Conditions

- You can assign up to 50 IP phones in an Internal or All call paging group.
- When using Unicast mode, there must be an available DSP recourse for each IP phone in the page group at the time of the internal page. If the resources are less than the number of IP phones, the page will be delivered to the IP phones with the lowest port numbers. IP phones that cannot obtain a DSP resource will not receive the page.
- IP terminals (DT7XX) via NAT cannot utilize Multicast paging. These terminals must use Unicast paging.
- The ability to assign Unicast or Multicast on an IP phone basis, is restricted to internal paging only. Other Multicast features (External MOH, Background Music, Room Monitor) cannot utilize Unicast.
- For an IP terminal to utilize the Multicast feature the IP terminal must have a gateway programmed to accomplish the multicast transmission. When an actual gateway device does not exist on the network, a dummy gateway address on the same subnet must be defined.
- When utilizing Multicast mode and a page group consists of all IP phones, the page is sent via a multicast message from the initiating phone. If a paging group has IP and TDM phones, when an IP phone initiates the page, a message is sent to the GPZ-IPLE and the GPZ-IPLE sends the Multicast message for the IP phones.
- SIP DECT Wireless phones cannot receive an Internal Page.
- When using the G.711 Codec for multicast paging, only 10ms, 20ms, 30ms, and 40ms frame sizes can be used.

### Default Settings

Multicast

## System Availability

### Terminals

All DT8XX/DT7XX IP Terminals

### Required Component(s)

- DT8XX/DT7XX IP terminal
- GCD-CP10 and GPZ-IPLE
- Router that supports Multicast Packets if utilizing Multicast Mode
- 0411 – SV9100 Version Lic (R1)
- 0300 – SV9100 Resource Lic
- 5103 – SV9100 IP Resource Lic
- 5111 – SV9100 IP Phone Lic

## Related Features

- ➔ [IP Multiline Station \(SIP\)](#)
- ➔ [Meet Me Paging](#)
- ➔ [Meet Me Paging Transfer](#)
- ➔ [Paging, External](#)
- ➔ [Paging, Internal](#)

## Guide to Feature Programming

The **Level 1**, **Level 2** and **Level 3** columns indicate the programs that are assigned when programming this feature in the order they are most commonly used. These levels are used with PCPro and WebPro wizards for feature programming.

- Level 1 – these are the most commonly assigned programs for this feature.
- Level 2 – these are the next most commonly assigned programs for this feature.
- Level 3 – these programs are not often assigned and require an expert level working knowledge of the system to be properly assigned.



Program Number	Program Name/Description	Input Data	Default	Level		
				1	2	3
10-19-01	<b>VoIP DSP Resource Selection</b> Select type of VoIP ETU DSP Resource. This program setting has no affect on the terminal/trunk port assignment or usage.	0 = Common use for both IP extensions and trunks 1 = IP Extension 2 = SIP Trunk 3 = CCIS/Networking 4 = Use for NetLink 5 = Blocked 6 = Common without Unicast Paging 7 = Multicast Paging 8 = Unicast Paging	Resource 1 = 1 Resource 2 ~ 256 = 0		✓	
10-46-11	<b>DT800/DT700 Server Information Setup – Multicast IP Address</b> Set the Multicast IP address so that two or more main devices don't overlap on the same network, or if Multicast is used by other IP services.	224.0.0.0 ~ 239.255.255.255	224.0.0.10			✓
10-46-12	<b>DT800/DT700 Server Information Setup – Multicast Port</b> Sets the starting port number used by Multicast.	0 ~ 65535	30000			✓
11-12-19	<b>Service Code Setup (for Service Access) – Internal Group Paging</b> Service code setup.	MLT, SLT 0 ~ 9, *, # Maximum of eight digits	701		✓	
15-05-38	<b>IP Telephone Terminal Basic Data Setup – Paging Protocol Mode</b> Sets the protocol mode for the Paging function. <i>With Version 5000 or higher, default is 1.</i>	0 = Multicast 1 = Unicast 2 = Auto	0 1	✓		
15-07-01	<b>Programmable Function Keys</b> Assign function keys for Internal Paging Zones (code 21 + page zone) and Internal All Call Paging (code 22).	Line Key 1 ~ 48 0 ~ 99 (Normal Function Code 751 by default) *00 ~ *99 (Appearance Function Code) (Service Code 752 by default)	Refer to the Programming Manual for default values.		✓	
20-06-01	<b>Class of Service for Extensions</b> Assign a Class of Service (1 ~ 15) to an extension.	Day Night/Mode: 1 ~ 8 Class of Service of Extensions (1 ~ 15)	Extension port 101 = Class 15 All other extension port = Class 1		✓	
20-13-29	<b>Class of Service Options (Supplementary Service) – Paging Display</b> Turn Off or On an extension user ability to display paging information.	0 = Off 1 = On	COS 1 ~ 15 = 1			✓

Program Number	Program Name/Description	Input Data	Default	Level		
				1	2	3
31-01-01	<b>System Options for Internal/External Paging – All Call Paging Zone Name</b> Assign a name to the All Call Internal Paging Zone. The name shows on the display of the telephone making the announcement.	Maximum of 12 characters.	Group All			✓
31-01-02	<b>System Options for Internal/External Paging – Page Announcement Duration</b> Set the maximum allowable duration for a Paging announcement (External Paging only).	0 ~ 64800 seconds	1200			✓
31-02-01	<b>Internal Paging Group Assignment – Internal Paging Group Number</b> Assign extensions to Internal Paging Zones. An extension must be assigned to a 2-digit zone to access any 2-digit zone.	Internal Page Zones: 0, 1 ~ 9, 00, 01 ~ 64 0 ~ 64 (0 = No Setting)	0 for IP Station 1 for TDM Station	✓		
31-02-02	<b>Internal Paging Group Assignment – Internal All Call Paging Receiving</b> Turn Off or On All Call Internal Paging for each extension. If allowed, extensions can make and receive All Call Internal Paging announcements. If prevented, extension can make only All Call Internal Paging announcements.	0 = Off 1 = On	0	✓		
31-03-01	<b>Internal Paging Group Settings – Internal Paging Group Name</b> Program names for the Internal Paging Zones.	Maximum of 12 characters.	01 = Group 1 02 = Group 2 : 64 = Group 64			✓
31-07-01	<b>Combined Paging Assignments</b> For each External Paging Group (1 ~ 8 and 0 for All Call), assign a corresponding Internal Zone for Combined Paging.	Internal Page Zones: 0, 1 ~ 9, 00, 01 ~ 64 0 ~ 64 (0 = All internal paging)	1		✓	

## Operation

### To make an Internal Page announcement

#### Multiline Terminal/IP Terminal

1. Press the zone **Internal Paging** key (Program 15-07 or SC 751: 21 + 0 or 1~9 or 01~64 for zones (0 or 00 for All Call).

- OR -

Press **Speaker** or lift the handset.  
Dial **701** and the Paging Zone number (0~9 or 00~64).

◇ *Dialing 0 or 00 calls All Call Internal Paging.*

- OR -

Dial **\*1** and the Combined Paging Group code 1~8 or 0 (for Internal/External All Call).

◇ *Display indicates the Combined Paging as an External Page.*

◇ *If the Internal Page Zone is busy or if there are no extensions in a page group, the page is announced as an External Page only.*

2. Make announcement.
3. Press **Speaker** to hang up.

#### **Single Line Telephone/SIP DECT Wireless**

1. Lift the handset.
2. Dial **701** and the Paging Zone number (0~9 or 00~64).
  - ◇ *Dialing 0 or 00 calls All Call Internal Paging.*
  - ◇ *Dial **\*1** and the Combined Paging Group code 1~8 or 0 (for Internal/External All Call).*
3. Make announcement.
4. Hang up.

## Uniform Call Distribution (UCD)

### Description

With Uniform Call Distribution (UCD), an extension user can call an idle extension in a preprogrammed UCD Group (Department Group – 64 Department Groups available) by dialing the group pilot number. For example, this would let a caller dial the Sales department just by knowing the Sales department pilot number. The caller would not have to know any of the Sales department extension numbers.

### User Log Out/Log In

An extension user can log out and log in to a UCD (Department) group. By logging out, the user removes their extension from the group. Once logged out, UCD (Department Calling) bypasses their extension. When they log back in, UCD (Department Calling) routes to their extension normally. All users can dial a code to log in or log out of their UCD (Department Calling) Group. A multiline terminal can optionally have a function key programmed for one-button log in and log out.

### Enhanced Hunting

UCD (Department Calling) is enhanced with expanded hunting abilities. Hunting sets the conditions under which calls to a UCD (Department Group) pilot number cycles through the members of the group. The hunting choices are:

- Busy**  
A call to the pilot number only hunts past a busy group member to the first available extension. A call rings on an unanswered extension until it is answered, or the caller hangs up.
- Not Answered**  
A call to the pilot number cycles through the idle members of a UCD (Department Calling) group. The call continues to cycle until it is answered or the calling party hangs up. However, if the next station in the cycle is busy when a new call comes in, the call queues to the busy agent. New calls do not hunt past a busy agent.
- Busy or Not Answered**  
A call to the pilot number cycles through the idle members of a UCD (Department Calling) group. The call continues to cycle until it is answered or the calling party hangs up.

If all members of the UCD (Department) group are busy, an incoming or transferred call to the group pilot number queues for an available member. Each group has a queue that can hold any number of waiting calls. If a display telephone is waiting in queue, the user sees: *WAITING (group name)*. If a transferred call in queue is an outside call, the queued caller hears, *“Please hold on. All lines are busy. Your call will be answered when a line becomes free.”*

The VRS can also transfer calls to UCD (Department) groups. Refer to the [Voice Response System \(VRS\) on page 2-1831](#) feature for more information on setting up the VRS.

The system prevents hunting to a UCD (Department) group extension if it is:

- Busy on a call
- In Do Not Disturb
- Call Forwarded
- Logged Out

### Conditions

- When a DIL rings to a UCD (Department) groups, the DIL may follow overflow programming (Program 22-01-04 and Program 22-08-01).
- If an extension has Call Forwarding set, the system does not hunt to the forwarded extension.

### Default Settings

Disabled

# Priority

Figure 2-104 Uniform Call Distribution (UCD) Priority Call Routing

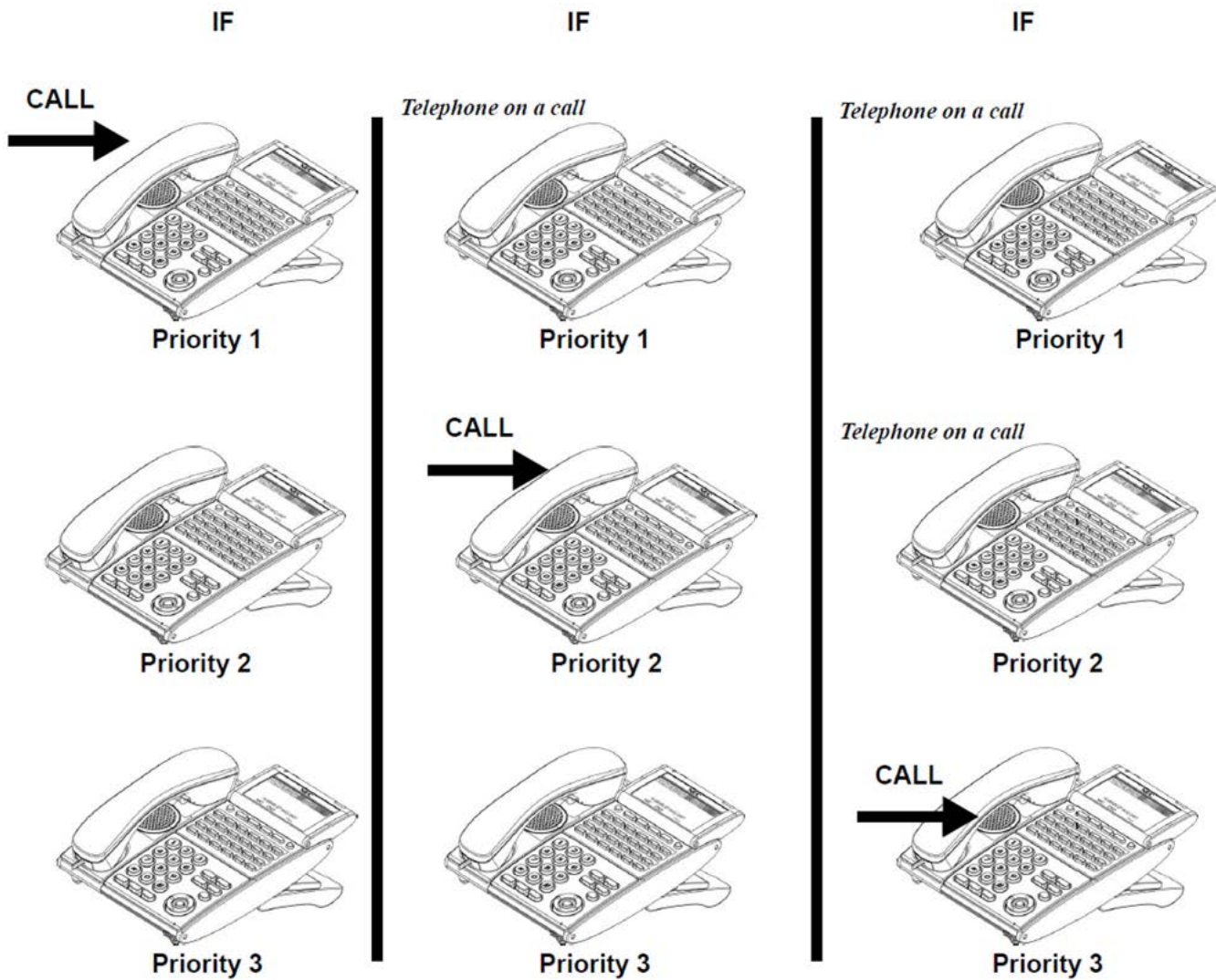

### Circular

Figure 2-105 Uniform Call Distribution (UCD) Circular Routing

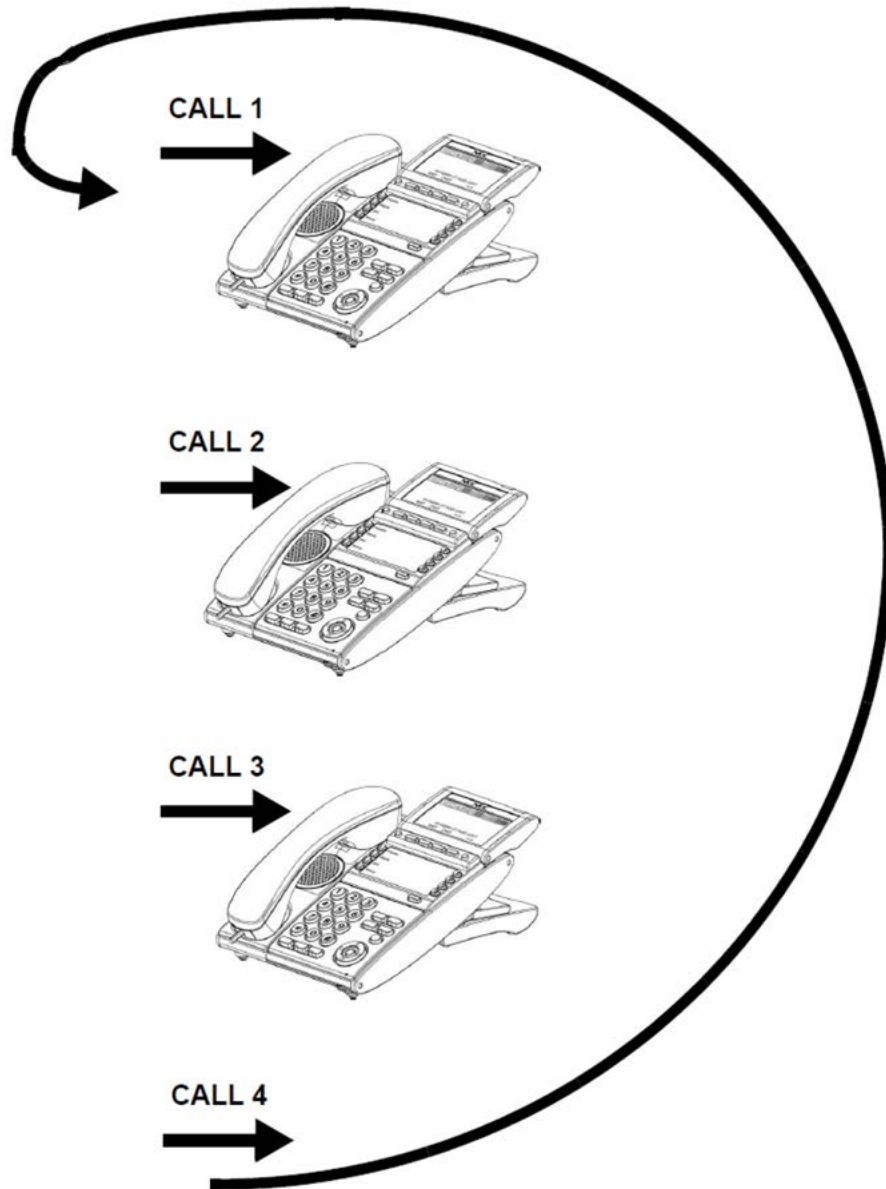

### System Availability

Terminals

All Terminals

## Required Component(s)

1001 – SV9100 InMail VRS Port Lic

## Related Features

- ➔ **Call Arrival (CAR) Keys**
- ➔ **Call Forwarding**
- ➔ **Contact Center**
- ➔ **Transfer**
- ➔ **InMail**
- ➔ **Voice Response System (VRS)**

## Guide to Feature Programming

The **Level 1**, **Level 2** and **Level 3** columns indicate the programs that are assigned when programming this feature in the order they are most commonly used. These levels are used with PCPro and WebPro wizards for feature programming.

- Level 1 – these are the most commonly assigned programs for this feature.
- Level 2 – these are the next most commonly assigned programs for this feature.
- Level 3 – these programs are not often assigned and require an expert level working knowledge of the system to be properly assigned.

Program Number	Program Name/Description	Input Data	Default	Level		
				1	2	3
11-07-01	<b>Department Group Pilot Numbers – Dial</b> Assign pilot numbers to the Extension (Department) Groups you set up in Program 16-02-01 ~ Program 16-02-10.	Maximum of eight digits.	No Setting	✓		
15-07-01	<b>Programmable Function Keys</b> Assign a Uniform Call Distribution key (46) so extension users can install or remove themselves from the Uniform Call Distribution Group. Additional keys can also be assigned for Department Group features Automatic Transfer (56), immediate calling destination (58), delayed calling destination (59), and DND destination (60).	Line Key 1 ~ 48 0 ~ 99 (Normal Function Code 751 by default) *00 ~ *99 (Appearance Function Code) (Service Code 752 by default)	Refer to the Programming Manual for default values.		✓	



Program Number	Program Name/Description	Input Data	Default	Level		
				1	2	3
16-01-01	<b>Department Group Basic Data Setup – Department Name</b> Assign a name to the Extension (Department) Groups.	Maximum of 12 characters.	No Setting	✓		
16-01-02	<b>Department Group Basic Data Setup – Department Calling Cycle</b> Set the call routing for Department Calling. Routing can be either circular (cycles to all phones in group) or priority (cycles to highest priority extension first) Set to 1 for UCD.	0 = Normal Routing (Priority) 1 = Easy – UCD Routing (Circular)	0	✓		
16-01-03	<b>Department Group Basic Data Setup – Department Routing When Busy (Auto Step Call)</b> Set how the system routes an Intercom call to a busy Department Group member. Intercom callers can hear busy or route to the first available Department Group member. This occurs only for calls to the extension directly, not the department number assigned in Program 11-07.	0 = Normal (Intercom caller to busy department member hears busy) 1 = Circular (Intercom callers to busy department member routes to idle member)	0	✓		
16-01-04	<b>Department Group Basic Data Setup – Hunting Mode</b> Set the action taken when a call reaches the last extension of the department group.	0 = Last extension is called and hunting is stopped 1 = Circular	0	✓		
16-01-05	<b>Department Group Basic Data Setup – Extension Group All Ring Mode Operation</b> Determine whether calls ringing a Department Group should ring all extensions in the group simultaneously automatically or manually when using the service code defined in Program 11-12-09. When set to 1 only ICM and DID calls ring all stations in the Department Group.	0 = Manual 1 = Automatic	0	✓		
16-01-06	<b>Department Group Basic Data Setup – STG Withdraw Mode</b> Set the STG withdraw mode for each department group.	0 = Disable (Camp On) 1 = Enable (Overflow Mode)	0	✓		
16-01-07	<b>Department Group Basic Data Setup – Call Recall Restriction for STG</b> Determine whether or not an unanswered call transferred to a Department Group should recall the extension from which it was transferred.	0 = Disable (Recall) 1 = Enable (No Recall)	0	✓		
16-01-09	<b>Department Group Basic Data Setup – Department Hunting No Answer Time</b> Set how long a call rings a Department Group extension before hunting occurs.	0 ~ 64800 seconds	15	✓		

Program Number	Program Name/Description	Input Data	Default	Level		
				1	2	3
16-01-10	<b>Department Group Basic Data Setup – Enhanced Hunt Type</b> Set the type of hunting for each Department Group.	0 = No queuing 1 = Hunting When Busy 2 = Hunting When Not Answered 3 = Hunting When Busy or No Answer	0	✓		
16-02-01	<b>Department Group Assignment for Extensions</b> Set up the Department Group called by the pilot number and the extension priority when a group is called. Call Pickup Groups are set up in 23-02.	Department Groups 1 ~ 64 Priority 1 ~ 9999	Default = 1 extensions in Department Group 1 with priority in port order: Port 1 priority = 1 Port 256 priority = 256	✓		
16-03-01	<b>Secondary Department Group</b> Assign extensions to multiple Department Groups and set the priority assignment. Each Secondary Department Group can have up to 16 extensions assigned.	Extension Number Maximum of eight digits Priority Order 0 ~ 9999	No Setting		✓	
20-06-01	<b>Class of Service for Extensions</b> Assign a Class of Service (1 ~ 15) to an extension.	Day Night/Mode: 1 ~ 8 Class of Service of Extensions (1 ~ 15)	Extension port 101 = Class 15 All other extension port = Class 1		✓	
20-09-07	<b>Class of Service Options (Incoming Call Service) – Call Queuing</b> Turn Off or On an extension user ability to have calls queued if a call rings the extension when it is busy. ➡ Program 20-13-06 must be set to 0 (Off) for this feature to work.	0 = Off 1 = On	COS 1 ~ 15 = 1		✓	
20-11-17	<b>Class of Service Options (Hold/Transfer Service) – Department Group Trunk-to-Trunk Transfer (Each Telephone Group Transfer)</b> Turn Off or On an extension user ability in a Department Group to use the Trunk-to-Trunk Forwarding service codes.	0 = Off 1 = On	COS 1 ~ 15 = 1		✓	
20-13-06	<b>Class of Service Options (Supplementary Service) – Automatic Off-Hook Signaling (Automatic Override)</b> Allow a busy extension to Manually (0) or Automatically (1) receive off-hook Signals. ➡ This setting is to receive incoming call signaling information during call queuing.	0 = Off 1 = On	COS 1 ~ 15 = 1		✓	

Program Number	Program Name/Description	Input Data	Default	Level		
				1	2	3
20-13-14	<p><b>Class of Service Options (Supplementary Service) – Department Calling (PLT No Called Extension)</b></p> <p>Turn Off or On an extension user ability to call a Department Group Pilot.</p>	<p>0 = Off 1 = On</p>	COS 1 ~ 15 = 1		✓	
22-02-01	<p><b>Incoming Call Trunk Setup</b></p> <p>If you want a trunk to be a DIL to a Department Group, assign Service Type 4 for each Night Service Mode. Also see Program 22-07-01.</p>	<p>0 = Normal 1 = VRS (second dial tone if no VRS installed) 2 = DISA 3 = DID 4 = DIL 5 = E&amp;M Tie line 6 = Delayed VRS 7 = ANI/DNIS 8 = DID(DDI) Mode Switching</p>	0		✓	
22-07-01	<p><b>DIL Assignment</b></p> <p>For each trunk assigned Service Type 4 in Program 22-02 above, assign the DIL destination as the Department Group pilot number (as assigned in Program 11-07-01). (Department: Groups 1 ~ 64).</p> <p>➡ For this selection to work, set Program 22-02-01 to 4 (DIL).</p>	<p>Day/Night Modes (1 ~ 8): Extension Number (maximum of eight digits) Pilot Number</p>	No Setting		✓	
24-02-05	<p><b>System Options for Transfer – Message Wait Ring Interval Time</b></p> <p>For Single Line Telephones (SLTs) without message waiting lamps, this is the time between intermittent ringing. If this value is 0, the system rings once.</p>	0 ~ 64800 seconds	30		✓	
24-02-08	<p><b>System Options for Transfer – Delayed Transfer Timer for All Department Groups</b></p> <p>Determine the time a call should ring a Department Group before transferring the call.</p>	0 ~ 64800 seconds	10		✓	
24-05-01	<p><b>Department Group Transfer Target Setup</b></p> <p>Use the Speed Dialing area to program the destination number of the transferred telephone number when a Department Group call is transferred using Trunk-to-Trunk Forwarding.</p>	0 ~ 9999	9999		✓	

## Operation

### To call a UCD Group:

1. At the multiline terminal, press **Speaker**.

- OR -

At single line telephone, lift the handset.

2. Dial the UCD group (department) extension or pilot number.
  - ◇ *The system routes the call to the first free telephone in the (UCD group) department.*

### To log out of your UCD (Department Calling) Group:

- ◇ *While you are logged out, UCD (Department Calling) cannot route calls to your extension.*
- 1. Press **Speaker**.
- 2. Dial **650** and **1**.
  - OR -
  - Press **Uniform Call Distribution Log In** key (Program 15-07 or SC 751: 46).
  - ◇ *The key lights while you are logged out.*

### To log back in to your UCD (Department Calling) Group:

- ◇ *While you log back in, Uniform Call Distribution routes calls to your extension.*
- 1. Press **Speaker**.
- 2. Dial **650** and **0**.
  - OR -
  - Press **UCD (Department Calling) Log In** key (Program 15-07 or SC 751: 46).
  - ◇ *The key goes out when you log back in.*

## Uniform Numbering Network

### Description

Uniform Numbering Network allows multiple or compatible systems to be connected in a network using Tie Lines. A station user can dial a system number and a station number (open numbering) or dial the station number only (closed numbering) to access any station. When the calling and called systems are not directly connected, several Tie Lines may be accessed to route the call. Each system extends the call to the next system until the final destination is reached. Networking provides a seamless connection of multiple systems into a single “virtual” communications system using Tie Lines with a unified numbering plan. Networking allows many companies to connect their telephone systems so they appear as one. An extension user in the network can easily dial another extension or transfer a call in the Networking System. Calls are passed from network node to network node using a protocol that contains information about the source, type, and destination of the call.

### Flexible Network Routing

Use network routes to set up single-channel networking between many separate systems – or use multiple networking channels per system for greater network performance. Data tables in the system program define the routing for each extension in each network node. These tables are easily customized to meet the requirements of each networking configuration. Users may place an intercom call or transfer a call to any extension at any location by dialing an extension number. The system analyzes each extension number received and determines how to route the call to its final destination. The feature which handles this route selection is called Flexible Routing (F-Routing). F-Routing also can select alternate routes to the destination extension if the primary destination is busy. Up to 120 routes are available for networking. After an extension number is dialed, the system checks the routing, accesses the assigned trunk group and places the call. Each extension is assigned a route or routes that decide which trunk group to access and any modified dialed data if required.

### Conditions

- Monitor the Uniform Numbering Network Access Code plan to avoid loss of Access Codes and to prevent duplicating codes.
- The distant system number can be programmed as 2~8 digits.
- The UNIVERGE SV9100 system has 500 ARS/F-Route Tables that can be shared by outgoing Tie lines, ISDN CO/PBX, and FT1 lines.
- When a call from/to the remote-end is made to a busy station in the UNIVERGE SV9100 system, the caller cannot set features such as Callback Message, Step Call, or Camp-On.
- A maximum of 120 Dial Analysis Tables allow a maximum of 121 connected systems per Uniform Numbering Network.
- DID Full Digit Conversion can access the Uniform Numbering Network.

### Default Settings

None

## System Availability

### Terminals

All Terminals

### Required Component(s)

GCD-4ODTA

**-OR-**

GCD-PRTA

## Related Features

- ➔ **Automatic Route Selection (ARS)**
- ➔ **Flexible System Numbering**
- ➔ **K-CCIS – IP**
- ➔ **K-CCIS – T1**
- ➔ **Multiple Trunk Types**

## Guide to Feature Programming

The **Level 1**, **Level 2** and **Level 3** columns indicate the programs that are assigned when programming this feature in the order they are most commonly used. These levels are used with PCPro and WebPro wizards for feature programming.

- Level 1 – these are the most commonly assigned programs for this feature.
- Level 2 – these are the next most commonly assigned programs for this feature.
- Level 3 – these programs are not often assigned and require an expert level working knowledge of the system to be properly assigned.

Program Number	Program Name/Description	Input Data	Default	Level		
				1	2	3
11-01-01	<p><b>System Numbering – Service Code</b></p> <p>Set the systems internal (Intercom) numbering plan. The numbering plan assigns the first and second digits dialed and affects the digits an extension user must dial to access other extensions and features, such as service codes and trunk codes. If the default numbering plan does not meet the site requirements, use this program to tailor the system numbering to the site.</p>	<p><b>Caution</b></p> <p>Improperly programming this option can adversely affect system operation. Make sure you thoroughly understand the default numbering plan before proceeding.</p> <p><b>Before changing your numbering plan, use PCPro or WebPro to make a backup copy of your system data.</b></p>	Refer to the Programming Manual for default values.	✓		
11-02-01	<p><b>Extension Numbering</b></p> <p>Set the extension number. The extension number can have up to eight digits. The first/ second digit(s) of the number should be assigned in Program 11-01-01. This allows an employee to move to a new location (port) and retain the same extension number.</p>	Maximum of eight digits.	1 101 2 102 3 103 ~ ~ 99 199 100 3101 ~ ~ 960 3961	✓		
14-02-09	<p><b>Analog Trunk Data Setup – Busy Tone Detection</b></p> <p>Enable/Disable busy tone detection for trunk ports.</p>	0 = Disable 1 = Enable	0		✓	
14-02-14	<p><b>Analog Trunk Data Setup – Loop Start/ Ground Start</b></p> <p>Define an analog trunk as Loop Start or Ground Start.</p>	0 = Loop Start 1 = Ground Start	0	✓		
14-05-01	<p><b>Trunk Group – Trunk Group Number</b></p> <p>Assign trunks to trunk groups (1 ~ 100).</p>	Trunk Port 1 ~ 400 Group Number 0 ~ 100 Priority 1 ~ 400	Default = Trunks 1 ~ 400 assigned to trunk group 1 with priorities equal to the trunk number. Trunk 1 = Priority 1 Trunk 400 = Priority 400.	✓		
44-01-01	<p><b>System Options for ARS/F-Route – ARS/ F-Route Time Schedule</b></p> <p>Set this option to 0 so the F-Route table selected is determined only by the digits dialed without any relation to the day or time of the call. If 1 is selected, the system refers to Program 44-10. If there is a match, the pattern defined in that program is used. If not, the F-Route pattern in Program 44-09 and the time set in 44-08 are used.</p>	0 = Not Used 1 = Used	0		✓	

Program Number	Program Name/Description	Input Data	Default	Level		
				1	2	3
44-02-01	<b>Dial Analysis Table for ARS/F-Route Access – Dial</b> Set the dial digits to be analyzed by the system for ARS routing.	Maximum of eight digits (Use line key 1 for a 'Don't Care' digit, @)	No Setting	✓		
44-02-02	<b>Dial Analysis Table for ARS/F-Route Access – Service Type</b> Select the Service Type.	0 = No Setting (None) 1 = Extension Call (Own) 2 = ARS/F-Route Table (F-Route) 3 = Dial Extension Analyze Table (Option)	0	✓		
44-02-03	<b>Dial Analysis Table for ARS/F-Route Access – Additional Data</b> Enter the additional data required for the service type selected in Program 44-02-02, either the number of digits to be deleted or the table number to be used.	1 = Delete Digit = 0 ~ 255 (255: Delete All Digits) 2 = 0 ~ 500 (0 = No Setting) 3 = Dial Extension Analyze Table Number = 0 ~ 4 (0 = No Setting)	0	✓		
44-02-04	<b>Dial Analysis Table for ARS/F-Route Access – Dial Tone Simulation</b> If Enabled (1), this option sends dial tone to the calling party after the routing is determined. This may be required if the central office at the destination does not send dial tone.	0 = Off 1 = On	0		✓	
44-03-01	<b>Dial Analysis Extension Table – Dial</b> Set the Dial digits (24 digits maximum) 1 ~ 9, 0 * #, @) to be used for the Dial Extension Analysis Table. When Program 44-02-02 is set to 3, this program sets the dial extension analysis table. These tables are used when the analyzed digits must be more than eight digits. To enter a wild card/don't care digit, press Line Key 1 to enter an @ symbol.	Maximum of 24 digits Digits = 1 ~ 9, 0, *, #, @ (Press Line Key 1 for wild character @)	No Setting		✓	
44-03-02	<b>Dial Analysis Extension Table – ARS/ F-Route Select Table Number</b> When dialed digits match the setting in Program 44-03-01, select the ARS/R-Route table number (0 ~ 500) to be used for the Dial Extension Analysis Table.	0 ~ 500 (ARS/F-Route Table Number) With Program 44-01 set to 0, Program 44-05 is checked. With Program 44-01 set to 1, Program 44-04 is checked.	0		✓	
44-03-03	<b>Dial Analysis Extension Table – ARS/ F-Route Select Table Number</b> If the received digits are not identified in tables 1 ~ 250, the F-Route selection table number (0 ~ 500) defined in table 251 is used.	0 ~ 500 (ARS/F-Route Table Number) With Program 44-01 set to 0, Program 44-05 is checked. With Program 44-01 set to 1, Program 44-04 is checked.	0		✓	



Program Number	Program Name/Description	Input Data	Default	Level		
				1	2	3
44-03-04	<b>Dial Analysis Extension Table – Next Table Area Number (252)</b> If the received digits do not match the digits set in tables 1 ~ 250, table number 252 is used refer to the next Extension Table Area (1 ~ 4) to be searched.	0 ~ 4	0		✓	
44-04-01	<b>ARS/F-Route Selection for Time Schedule</b> Assign each ARS/F-Route Selection number (1 ~ 500) to an ARS/F-Route table number for each ARS/F-Route time mode.	ARS/F-Route Time Mode: 1 ~ 8 ARS/F-Route Table Number = 0 ~ 500	0		✓	
44-05-01	<b>ARS/F-Route Table – Trunk Group Number</b> Select the trunk group number used for the outgoing ARS call (1 ~ 100).	0 = No Setting 1 ~ 100 = Trunk Group from Program 14-05 101 ~ 150 = Networking 255 = Extension Call	0	✓		
44-05-02	<b>ARS/F-Route Table – Delete Digits</b> Enter the number of digits to be deleted from the dialed number [0 ~ 255 (255 = Delete all)].	0 ~ 255 (255 = Delete All)	0	✓		
44-05-03	<b>ARS/F-Route Table – Additional Dial Number Table</b> Enter the table number defined in Program 44-06 for additional digits to be dialed (0 ~ 1000).	0 ~ 1000	0	✓		
44-05-04	<b>ARS/F-Route Table – Beep Tone</b> For each ARS/F-Route table (1 ~ 500) assign a priority number (1 ~ 4). Turn Off or On a beep tone if a lower priority trunk group is used.	0 = Off (No Beep) 1 = On (Beeps)	0		✓	
44-05-05	<b>ARS/F-Route Table – Gain Table Number for Internal Calls</b> For each ARS/F-Route table (1 ~ 500) assign a priority number (1 ~ 4). Select the gain table number used for internal call (defined in Program 44-07).	0 ~ 500 0 = No Setting	0		✓	
44-05-06	<b>ARS/F-Route Table – Gain Table Number for Tandem Connections</b> For each ARS/F-Route table (1 ~ 500) assign a priority number (1 ~ 4). Select the gain table number used for the tandem call (defined in Program 44-07).	0 ~ 500 0 = No Setting	0		✓	
44-05-07	<b>ARS/F-Route Table – ARS Class of Service</b> For each ARS/F-Route table (1 ~ 500) assign a priority number (1 ~ 4). Select the Class of Service used for ARS. An extension ARS COS is determined in Program 26-04-01.	0 ~ 16	0		✓	

Program Number	Program Name/Description	Input Data	Default	Level		
				1	2	3
44-05-08	<b>ARS/F-Route Table – Dial Treatment</b> For each ARS/F-Route table (1 ~ 500) assign a priority number (1 ~ 4). Select the Dial Treatment to be used for the table. The Dial Treatments are determined in Program 26-03-01.	0 ~ 15	0	✓		
44-05-09	<b>ARS/F-Route Table – Maximum Digit</b> Input the maximum number of digits to send when using the F-Route.	0 ~ 24	0		✓	
44-05-10	<b>ARS/F-Route Table – CCIS over IP Destination Point Code</b> Input the Destination Point Code to send when using F-Route.	0 ~ 16367	0		✓	
44-05-11	<b>ARS/F-Route Table – Network Specified Parameter Table</b> Enter a table number from Program 26-12.	0 ~ 16	0		✓	
44-06-01	<b>Additional Dial Table</b> Set the additional dial table to add prior to the dialed ARS/F-Route Number. The Additional Dial Table used is determined in Program 44-05-03. Define the additional dial table (1 ~ 1000) to add digits in front of the dialed ARS/F-Route number.	Maximum of 24 digits Enter: 1 ~ 9, 0, *, #, Pause (press line key 1 to enter a pause)	No Setting		✓	
44-07-01	<b>Gain Table for ARS/F-Route Access – Incoming Transmit</b>	Set the gain table to be used (1 ~ 500). If an extension dials ARS/F-Route number; The Extension Dial Gain Table assigned in Program 44-05 is activated.	1 ~ 63 (-15.5 ~ +15.5dB) (default = 32)		✓	
44-07-02	<b>Gain Table for ARS/F-Route Access – Incoming Receive</b>	The Extension Dial Gain Table follows Outgoing transmit and Outgoing receive settings.	1 ~ 63 (-15.5 ~ +15.5dB) (default = 32)		✓	
44-07-03	<b>Gain Table for ARS/F-Route Access – Outgoing Transmit</b>	If the incoming call is transferred to another line using ARS/F-Route; the Tandem Gain Table assigned in Program 44-05 is activated.	1 ~ 63 (-15.5 ~ +15.5dB) (default = 32)		✓	
44-07-04	<b>Gain Table for ARS/F-Route Access – Outgoing Receive</b>	The Tandem Gain Table follows the Incoming transmit and Incoming receive settings for incoming line, and Outgoing transmit and Outgoing receive settings for the outgoing line.  For ARS/F-Route calls, the CODEC gains defined in Program 14-01-02 and Program 14-01-03 are not activated.	1 ~ 63 (-15.5 ~ +15.5dB) (default = 32)		✓	

Program Number	Program Name/Description	Input Data	Default	Level		
				1	2	3
44-08-01	<b>Time Schedule for ARS/F-Route</b> Define the daily pattern of the ARS/F-Route feature. ARS/F-Route has 10 time patterns. These patterns are used in Program 44-09 and Program 44-10. The daily pattern consists of 20 time settings.	Time Number: 01 ~ 20 Start Time = 0000 ~ 2359 End Time = 0000 ~ 2359 Mode: 1 ~ 8	All Schedule Patterns: 0:00 – 0:00, Mode 1		✓	
44-09-01	<b>Weekly Schedule for ARS/F-Route</b> Define a weekly schedule for using ARS/F-Route day numbers 1 ~ 7, pattern numbers (1 ~ 10). The pattern number is defined in Program 44-08-01.	1 = Sunday (Pattern 1 ~ 10) 2 = Monday (Pattern 1 ~ 10) 3 = Tuesday (Pattern 1 ~ 10) 4 = Wednesday (Pattern 1 ~ 10) 5 = Thursday (Pattern 1 ~ 10) 6 = Friday (Pattern 1 ~ 10) 7 = Saturday (Pattern 1 ~ 10)	Pattern 1		✓	
44-10-01	<b>Holiday Schedule for ARS/F-Route</b> Define a yearly schedule for ARS/F-Route. This schedule is used for setting special days such as national holidays (pattern numbers 1 ~ 10). The pattern number is defined in Program 44-08-01.	Date: 0101 ~ 1231 Schedule Pattern Number = 0 ~ 10 0 = No Setting	Date: 0101~1231 Schedule Pattern Number = 0~10 0 = No Setting (default = 0)		✓	

## Operation

None

## Universal Slots

### Description

The UNIVERGE SV9100 has six universal slots, and up to four cabinets can be installed. The system uses the same chassis for the 64, 256 and unlimited systems to support up to 24 Universal Slots.

Up to four combined CHS2UG B-US/CHS2UG E (3-Slot Base/3-Slot Expansion) or CHS2UG-US (6-Slot) chassis can be connected locally to reach the system's maximum port capacity.

**EXAMPLE:**

- 0 CHS2UG-US (19" Chassis) & 4 CHS2UG B-US/CHS2UG E (9.5" Base Chassis/9.5" Expansion Chassis)
- 1 CHS2UG-US (19" Chassis) & 3 CHS2UG B-US/CHS2UG E (9.5" Base Chassis/9.5" Expansion Chassis)
- 2 CHS2UG-US (19" Chassis) & 2 CHS2UG B-US/CHS2UG E (9.5" Base Chassis/9.5" Expansion Chassis)
- 3 CHS2UG-US (19" Chassis) & 1 CHS2UG B-US/CHS2UG E (9.5" Base Chassis/9.5" Expansion Chassis)
- 4 CHS2UG-US (19" Chassis) & 0 CHS2UG B-US/CHS2UG E (9.5" Base Chassis/9.5" Expansion Chassis)

### Conditions

- Two software packages (Basic Port Package and Expanded Port Package) are available for the UNIVERGE SV9100 system using the GCD-CP10. Refer to [Table 2-139 SV9100 Maximum System Capacities – Trunks/Ports/Channels on page 2-1729](#) for maximum system capacities for each software package.

Table 2-139 SV9100 Maximum System Capacities – Trunks/Ports/Channels

Number of:		9.5" Chassis	19" Chassis				System Maximum
		x 1 (CPU + 2 Slots)	x 1 (6 Slots)	x 2 (12 Slots)	x 3 (18 Slots)	X4 (24 Slots)	
Number of Timeslots *1	PCM	48	104	208	312	416	444
	Data	7	7	14	21	28	28
DT400/DT300 TDM (-48V)		32	80	176	272	368	Total 896
SLT (-28V)		32	80	176	272	368	
SLT (-48V)		8	20	44	68	92	
DT800/DT700 IP		896					
Desktop Applications (Desktop Client, Desktop Client with Shared Services and SoftPhones)		256					Total 256
SIP/WLAN		896					Total 896
Analog Trunks (COT)		16	40	88	136	184	Total 400
BRI		16	40	88	136	184	
PRI (1.5M)		48	96	192	288	384	
IP Trunk (SIP)		400					
DTMF Receivers		80	80	144	144	144	144 *2
VoIP Channels		256					256
Voice Mail Channels on CPU		16 channels					16
V34 Modem		1 channel					1

\*1 = For  $\mu$ -law countries 104 timeslots per chassis are assigned the G.711 PCM communications (e.g., voice communications) and 7 timeslots per chassis are assigned for the Data communications (e.g., HDLC over ISDN). Thus the simultaneous data communications are limited up to seven per chassis.

\*2 = An additional 64 DTMF Receivers are available when the GPZ-BS10 is installed.

➤ If using Caller ID to analog trunks and DSP resources are set to common, DSP resources will only be used for analog trunks and not analog stations.

Table 2-140 SV9100 9.5" (Base and Expansion) Maximum System Capacities – Trunks/Ports/Channels

Number of:		9.5" Base	9.5" Base + Expansion				System Maximum
		x 1 (CPU + 2 Slots)	x 1 (6 Slots)	x 2 (12 Slots)	x 3 (18 Slots)	X4 (24 Slots)	
Number of Timeslots *1	PCM	48	104	208	312	416	444
	Data	7	7	14	21	28	28
DT400/DT300 TDM (-48V)		32	80	176	272	368	Total 896
SLT (-28V)		32	80	176	272	368	
SLT (-48V)		8	20	44	68	92	
DT800/DT700 IP		896					
Desktop Applications (Desktop Client, Desktop Client with Shared Services and SoftPhones)		256					Total 256
SIP/WLAN		896					Total 896
Analog Trunks (COT)		16	40	88	136	184	Total 400
BRI		16	40	88	136	184	
PRI (1.5M)		48	96	192	288	384	
IP Trunk (SIP/K-CCIS – IP)		400					
DTMF Receivers		80	80	144	144	144	144 *2
VoIP Channels		256					256
Voice Mail Channels on CPU		16 channels					16
V34 Modem		1 channel					1

\*1 = For  $\mu$ -law countries 104 timeslots per chassis are assigned the G.711 PCM communications (e.g., voice communications) and 7 timeslots per chassis are assigned for the Data communications (e.g., HDLC over ISDN). Thus the simultaneous data communications are limited up to seven per chassis.

\*2 = An additional 64 DTMF Receivers are available when the GPZ-BS10 is installed.

➤ If using Caller ID to analog trunks and DSP resources are set to common, DSP resources will only be used for analog trunks and not analog stations.

- Each Universal Slot is capable of 24 ports.
- The Basic Port Package is limited to one chassis.
- The PRTA blades can be programmed as a 4/8/12/16/20/24 port Fractional T1/PRI. Program 10-39-01 must be Enabled).
- If trying to assign a blade which would exceed the maximum number of ports for the Basic Port Package you do not get an error, but it does not let you program the related programs.
- The 9.5" chassis can now accommodate two GCD-LTA (combo) blades in the universal slots. Both blades can be viewed and accessed via PC Pro.
- The available interface blades and maximum capacities for Universal Slots with the UNIVERGE SV9100 system are shown in [Table 2-141 Maximum System Capacities for Station Interface Blades](#), [Table 2-142 Maximum System Capacities for Trunk Interface Blades on page 2-1734](#) and [Table 2-143 Maximum System Capacities for Application Interface Blades on page 2-1736](#).

Table 2-141 Maximum System Capacities for Station Interface Blades

Station Interface Units	Description	Maximum Capacities		Notes
		Basic Port Package	Expanded Port Package	
<b>GCD-8DLCA</b>	<p>This 8-port Digital Line Blade contains eight circuits. Each circuit can support any Attendant Console, multiline terminal, or Single Line Telephone adapter.</p> <p>This blade is installed in slots 2~6 of a chassis with CPU and slots 1~6 of expansion chassis. The maximum number depends on other station blades installed. This blade shares the total number of extension ports in the system.</p> <p>No more than 80 DLC ports are supported in a single chassis.</p>	<b>5</b>	<b>22</b>	<b>Note: 1</b>
<b>GCD-16DLCA</b>	<p>These blades are 16-port. Each circuit can support any Attendant Console, multiline terminal, or Single Line Telephone adapter.</p> <p>This blade is installed in slots 2~6 of a chassis with CPU and slots 1~6 of expansion chassis. The maximum number depends on other station blades installed. This blade shares the total number of extension ports in the system.</p> <p>No more than 80 ESI ports are supported in a single chassis.</p>	<b>5</b>	<b>22</b>	<b>Note: 1</b>

Table 2-141 Maximum System Capacities for Station Interface Blades (Continued)

Station Interface Units	Description	Maximum Capacities		Notes
		Basic Port Package	Expanded Port Package	
<b>GCD-4DIOPA</b>	<p>This 4-port Analog DID or Off-Premise Extension blade provides termination and operation of four analog DID trunks or four off premise extensions. Each blade has a built-in ringer signal generator (RSG). Up to 1600 ohms of resistance (including the single line instrument) is acceptable between the blade and the single line telephone.</p> <p>This blade is installed in slots 2~6 of a chassis with CPU or slots 1~6 of expansion chassis and shares the number of station ports in the system.</p>	<b>5</b>	<b>22</b>	<b>Note: 1</b>
<b>GCD-4LCA</b>	<p>This 4-port Single Line Interface blade supports four Single Line Telephones and/or analog voice mail ports. Each blade provides a built-in ringer signal generator (RSG) and Message Waiting (MW) LED voltage to single line telephones.</p> <p>This blade is installed in slots 2~6 of a chassis with CPU and slots 1~6 of expansion chassis. The maximum number depends on other station blades installed. This blade shares the total number of station ports in the system.</p>	<b>5</b>	<b>22</b>	<b>Note: 1</b>
<b>GCD-8LCA</b>	<p>This 8-port Single Line Interface blade supports eight Single Line Telephones and/or analog voice mail ports. Each blade provides a built-in ringer signal generator (RSG) and Message Waiting (MW) LED voltage to single line telephones.</p> <p>This blade is installed in slots 2~6 of a chassis with CPU and slots 1~6 of expansion chassis. The maximum number depends on other station blades installed. This blade shares the total number of station ports in the system.</p>	<b>5</b>	<b>22</b>	<b>Note: 1</b>



Table 2-141 Maximum System Capacities for Station Interface Blades (Continued)

Station Interface Units	Description	Maximum Capacities		Notes
		Basic Port Package	Expanded Port Package	
<b>GPZ-4LCA</b>	This daughter board is a 4-port Single Line Interface. The GPZ-4LCA is installed on the GCD-4LCA, and supports four single line telephones with built-in ringer signal generator (RSG) and Message Waiting (MW) LED voltage to single line telephones.  The GCD-4LCA with a GPZ-4LCA is installed in slots 2~6 of a chassis with CPU and slots 1~6 of expansion chassis. The maximum number depends on other station blades installed. This daughter board shares the total number of station ports in the system.	<b>4</b>	<b>21</b>	<b>Note: 1</b>
<b>GPZ-8LCE</b>	The GPZ-8LCE daughter board is mounted on the GCD-4LCA/GCD-8LCA. This board provides an 8-Port Single Line analog extension (used for on-premise analog telephones, fax machines, and analog modems).	<b>4</b>	<b>22</b>	<b>Note: 1</b>
<b>GCD-4LCF</b>	The GCD-4LCF blade provides four analog (SLIU) extension ports (used for on-premise analog telephones, fax machines, and analog modems).	<b>3</b>	<b>21</b>	<b>Note: 1</b>
<b>GCD-8LCF</b>	The GCD-8LCF blade provides eight analog (SLIU) extension ports (used for on-premise analog telephones, fax machines, and analog modems).	<b>3</b>	<b>21</b>	<b>Note: 1</b>
<b>GPZ-4LCF</b>	The GPZ-4LCF daughter board is mounted on the GCD-4LCF/GCD-8LCF. This board provides 4-Port Single Line analog extension ports (used for on-premise analog telephones, fax machines, and analog modems).	<b>3</b>	<b>21</b>	<b>Note: 1</b>
<b>GPZ-8LCF</b>	The GPZ-8LCF daughter board is mounted on the GCD-4LCF/GCD-8LCF. This board provides 8-Port Single Line analog extension ports (used for on-premise analog telephones, fax machines, and analog modems).	<b>3</b>	<b>21</b>	<b>Note: 1</b>

Note 1: Calculating maximum capacities is based on the system having a minimum of eight Digital Line (DLC) ports, four trunk ports.

Note 2: A maximum of 16 Digital Voice Mail ports are available.

Note 3: Refer to the Board Power Factor Chart.

Table 2-142 Maximum System Capacities for Trunk Interface Blades

Trunk Interface Blades	Description	Maximum Capacities		Notes
		Basic Port Package	Expanded Port Package	
<b>GCD-2BRIA/ GPZ-2BRIA</b>	This 2/4-port Basic Rate Interface for up to eight trunks provides four channels (eight voice channels) for an ISDN-Basic Rate Interface. Caller ID is supported. This blade is installed in slots 2~6 of a chassis with CPU and slots 1~6 of expansion chassis. The maximum number depends on other trunk blades installed. This blade shares the total number of CO/PBX lines in the system.	<b>5</b>	<b>21</b>	<b>Note: 1</b>
<b>GCD-4COTB</b>	This 4-port CO/PBX Line Interface has built-in fuses (posistors), supports four outside (CO/PBX) lines, and provides circuitry for ring detection, holding and dialing. The outside lines must be Loop Start DTMF trunks. This blade is installed in slots 2~6 of a chassis with CPU and slots 1~6 of expansion chassis. The maximum number depends on other trunk blades installed.  This blade shares the total number of CO/PBX lines in the system.	<b>5</b>	<b>22</b>	<b>Note: 1</b>
<b>GPZ-4COTF Daughter Board</b>	This 4-port CO/PBX Line Interface has built-in fuses (posistors), supports eight outside (CO/PBX) lines, and provides circuitry for ring detection, holding and dialing. The outside lines must be Ground Start DTMF trunks. This daughter board is installed on a GCD-4COTB or GCD-LTA. The maximum number depends on other trunk blades installed.  This daughter board shares the total number of CO/PBX lines in the system.	<b>5</b>	<b>23</b>	<b>Note: 1</b>

Table 2-142 Maximum System Capacities for Trunk Interface Blades (Continued)

Trunk Interface Blades	Description	Maximum Capacities		Notes
		Basic Port Package	Expanded Port Package	
<b>GCD-PRTA</b>	<p>This T1/FT1 Trunk Interface or ISDN-Primary Rate digital trunk terminates Fractional T1 trunks (Up to 24 DS-0 channels). This blade supports ANI/ DNIS trunks, and CSU less function on T1. A combination of ground start and loop start signaling can be used on the GCD-PRTA. Dial pulse dialing, DTMF, Tie Line (E&amp;M), and DID are supported. This blade has 24 built-in DTMF detectors. Trunks are assigned in groups of four.</p> <p>When channels are assigned to ANI, Feature Group D is supported. Feature Group D incoming MF/outgoing DTMF signaling with point-to-point E&amp;M Tie Lines are also supported.</p> <p>This blade is installed in slots 2~6 of a chassis with CPU and slots 1~6 of expansion chassis. The maximum number depends on other trunk blades installed. This blade shares the total number of CO/ PBX lines in the system.</p>	<b>3</b>	<b>16</b>	<b>Note: 1</b>
<b>GCD-CCTA</b>	<p>The GCD-CCTA (Common Channel Handler) is an optional blade that provides a common channel signal through the GCD-CCTA to a K-CCIS network and controls the signaling between the KTS and the CP00. Each GCD-CCTA blade supports one K-CCIS link.</p> <p>Four GCD-CCTA blades can be installed per system. The T1 interface has a single 24 channel 64kb/s digital signal circuit which can be configured either for T1 trunking.</p>	<b>3</b>	<b>4</b>	<b>Note: 1</b>

Table 2-142 Maximum System Capacities for Trunk Interface Blades (Continued)

Trunk Interface Blades	Description	Maximum Capacities		Notes
		Basic Port Package	Expanded Port Package	
<b>GCD-4ODTA</b>	<p>The GCD-4ODTA Tie Line blade is an out band dial type analog tie line interface blade. This blade supports system connections to either 2-wire (four lead, tip/ring) or 4-wire (eight lead, tip/ring/tip 1/ring 1) E&amp;M signaling tie lines (determined in Program 10-03). System programming is also used to select the connection types with Type 1 or Type V.</p> <p>The GCD-4ODTA consumes 4 ports ranging between ports 001~200. This blade is installed in slots 2-6 of a chassis with CPU and slots 1-6 of expansion chassis. The maximum number depends on other trunk blades installed. This blade shares the total number of CO/PBX lines in the system.</p>	<b>3</b>	<b>21</b>	<b>Note: 1</b>

Note 1: Calculating maximum capacities are based on the system having a minimum of eight Digital Line (DLC) ports, four trunk ports.

Note 2: Refer to [Table 2-144 Board Power Factor on page 2-1737](#).

Table 2-143 Maximum System Capacities for Application Interface Blades

Application Interface Blades	Description	Maximum Capacities		Notes
		Basic Port Package	Expanded Port Package	
<b>GCD-VM00</b>	This GCD-VM00 is a PC platform that contains data storage for voice recording and application software supporting a maximum of 16 ports.	<b>1</b>	<b>1</b>	<b>Note: 1</b>
<b>GCD-ETIA</b>	The GCD-ETIA is an 8-port Gigabit Switch that provides Power over Ethernet (POE).	<b>1</b>	<b>1</b>	<b>Note: 1</b>
<b>GCD-PVAA</b>	The GCD-PVAA is a 16-port blade for the PVA PMS or IVR applications.	<b>2</b>	<b>2</b>	<b>Note: 1</b>

Table 2-143 Maximum System Capacities for Application Interface Blades (Continued)

Application Interface Blades	Description	Maximum Capacities		Notes
		Basic Port Package	Expanded Port Package	
<b>GCD-RGA</b>	The GCD-RGA blade is a 4-port switch and router which complies with the Ethernet specification for 10 Base-T, 100 Base-TX and 1000 Base-TX. This blade is compatible in LAN applications using 10Mbps, 100Mbps and 1000Mbps. All ports automatically identify and switch 10 Base-T, 100 Base-TX, 1000 Base-TX and Full/Half-Duplex.	<b>1</b>	<b>1</b>	<b>Note: 1</b>

Note 1: Refer to [Table 2-144 Board Power Factor](#).

- Refer to the SV9100 General Description Manual or System Hardware Manual for more information.
- The following Blade Calculator allows you to determine the maximum power consumption for each cabinet.

Table 2-144 Board Power Factor

Board Power Factor	
<b>Total</b>	<b>=&lt;7</b>
Item	Power Factor
<b>GCD-CP10</b>	1
<b>GCD-VM00</b>	2
<b>GCD-ETIA</b>	2
<b>GCD-PVAA</b>	1
<b>GPZ-IPLE</b>	2
<b>GCD-SVR2</b>	2
<b>GCD-RGA</b>	1

Table 2-145 Terminal Power Factor

Terminal Power Factor		
19 inch Metal Chassis with Fan = <80 9.5 inch Plastic Chassis without Fan =<64		
	Item	Power Factor
SLT	Standard (-28V)	0.8
	Long Line (-48V)	2
DT300/DT400 Series	Economy (DTL/DTZ 2-, 6- or 12-Button)	0.8
	Value (DTL/DTZ 12-, 24 or 32-Button)	0.8
	Value (DTL/DTZ DESI-Less)	0.8
	Value (DTL 12-Button) with BCH	3
	Value (DTL 12-Button) with PSA	2
DT300/DT400 Series Optional	DSS Console	2
	Power Save Adapter (PSA)	1.2
	Line Key Unit (8- or 16-Button)	0
	Ancillary Device Adapter (ADA)	2
	Analog Port Adapter with Ringer (APR)	2
	Bluetooth Cordless Handset (BCH)	2
	Bluetooth Hub Adapter (BHA)	2
DT700/DT800 Series (PoE from GCD-ETIA)	Economy (ITL 2- or 6-Button)	4
	Economy (ITL DESI-Less)	4
	Entry Level (ITY 6-Button)	4
	Entry Level (ITY DESI-Less)	4
	Value (ITL/ITZ 12-, 24 or 32-Button)	4
	Value (ITL/ITZ DESI-Less)	4
	Value (ITL 12-Button) with PSA	4
	Sophi (ITL 32-Button)	6
	Cradle (2-Button)	4
	Ancillary Device Adapter (ADA)	2
	Bluetooth Connection Adapter (BCA)	2
Paging Adapter (PGD(2)-U10 ADP)		2
IP Video Doorphone (IP3NE-IPCDH)		8

Table 2-146 Maximum Number of Packages Installed

Board (Power Factor)	Maximum Number of Package Installed			
	9.5 inch with CCPU	19 inch with CCPU	19 inch without CCPU	4 x 19 inch
GCD-ETIA (2)	2	3	3	12
GCD-PVAA (1)	2	5	6	23
GCD-SVR2	2	2	3	11
GCD-RGA	1	1	1	1

### Default Settings

None

### System Availability

#### Terminals

None

#### Required Component(s)

Any Blade

### Related Features

None

### Guide to Feature Programming

The **Level 1**, **Level 2** and **Level 3** columns indicate the programs that are assigned when programming this feature in the order they are most commonly used. These levels are used with PCPro and WebPro wizards for feature programming.

- Level 1 – these are the most commonly assigned programs for this feature.
- Level 2 – these are the next most commonly assigned programs for this feature.
- Level 3 – these programs are not often assigned and require an expert level working knowledge of the system to be properly assigned.

◇ The items highlighted in gray are read only and cannot be changed.

Program Number	Program Name/Description	Input Data	Default	Level		
				1	2	3
<b>10-03-01</b>	<b>ETU Setup</b> Set up and confirm the basic configuration data for each blade. This program represents different data depending on the blade installed in the slot. Refer the SV9100 Programming Manual for a more detailed description of this program.	The assigned data varies depending on the blade installed in the slot.	Refer to the Programming Manual for a more detailed description of the 10-03-XX programs.	✓		
<b>90-34-01</b>	<b>Firmware Information – Pkg Name</b> List the package type and firmware for the packages installed.	The data varies depending on the card in the slot.		✓		
<b>90-34-02</b>	<b>Firmware Information – Firmware Version Number</b> View the package name and firmware for each blade.	The data varies depending on the card in the slot.		✓		

## Operation

None



## User Programming Ability

### Description

A station user can perform programming functions. Speed Group Dialing and Function Keys are just two features programmable from a station.

#### Conditions

- Multiline terminals must be idle and Off-Hook and have entered the service code when programming any function.

#### Default Settings

None

### System Availability

#### Terminals

All Terminals

#### Required Component(s)

None

### Related Features

- ↪ **Clock/Calendar Display**
- ↪ **Code Restriction**
- ↪ **One-Touch Calling**
- ↪ **Programmable Function Keys**
- ↪ **Speed Dial – System/Group/Station**

### Guide to Feature Programming

None

## Operation

None

### Description

With Version 4000 or higher software, Video Conference with WebRTC supports video conferencing, voice conferencing and screen sharing. This feature allows users to enable video conferencing using a unified communication Web Application in a browser supporting WebRTC and Web sockets. WebRTC allows real time communication without any downloads or plugins. With a device and browser supporting WebRTC, video conferencing can be used without requiring application setup or installation.

Administrators or other users can access the Web Application from the link <https://sv9100/uc/>. Once downloaded, the Web Application can be used to create a conference. Users then distribute the URL [https://sv9100/uc/conf?id=\[Conference-ID\]](https://sv9100/uc/conf?id=[Conference-ID]) inviting participants to the conference.



NOTE

*The / must be included at the end of the URL or the page will not load.*

The Web Application also requests access to the device's camera and MIC for video and audio conferencing. All clients are connected through P2P connections and video conferencing is achieved by using a full mesh system (refer to [Audio/Video Conferencing using WebRTC on page 2-1744](#)).

### NAT Traversal

With Version 5000 or higher, the NAT Traversal is supported for this feature. The STUN/TURN server can be used to achieve NAT Traversal. First STUN is used to test the possibility of peer-to-peer communication via NAT. If STUN is successful the peer-to-peer communication is established. If STUN fails, TURN is used for Relay communication where the TURN server acts as a Relay Server. If this occurs, clients make connection with the external TURN server and the TURN server relays further to other clients. Contact the organization's Network Administrator for requirements and configurations on the Routers/Firewalls for NAT Traversal. If the SV9100 resides on a private network, Port Forwarding can be used to access the application from public networks. The application can be accessed on the same port as WebPro.

The following are the STUN/TURN servers that have been tested:

#### Stun Server: Port

*stun.1.google.com : 19302*  
*stun.ekiga.net : 3478*  
*numb.viagenie.ca : 3478*  
*stun.iptel.org : 3478*

**TURN Server: Port**

*numb.viagenie.ca* : 3478

For the TURN Server, the user needs to create an account on the server's website (<http://numb.viagenie.ca/>). After the account is created, the user will be provided with credentials via email used for authentication with this server.

Figure 2-106 Audio/Video Conferencing using WebRTC

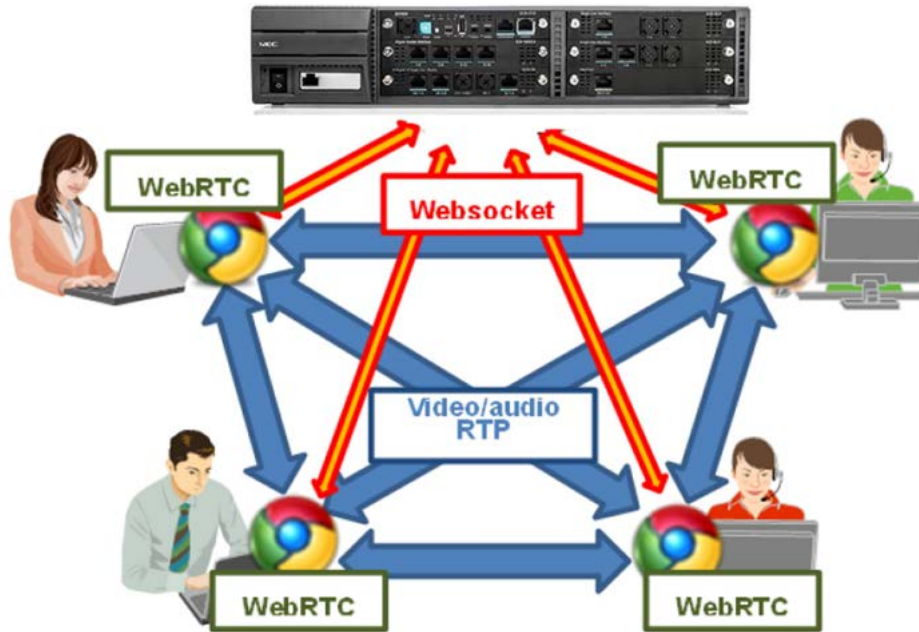
**Enhancements**

- With Version 5000 or higher NAT Traversal is supported when using the STUN/TURN server.

**Conditions**

- The number of conference sessions depend on the number of Web Video Conference License (0080). The maximum number of supported sessions is 32.
- Each client on the network should be able to establish P2P communication with each other.
- A maximum of four conferences is supported at one time.
- A maximum of eight users can participate in a conference.
- If a media connection between clients cannot be established or 90 seconds passes without a media connection being established, the screen displays **Impossible media connection**.
- NAT traversal is not supported with Version 4000 or lower.
- With Version 5000 or higher NAT Traversal is supported using the STUN/TURN server.

- In some routers it may be necessary to configure the NAT type to allow the STUN messages.
- In some NAT types (e.g. Symmetric NAT) the STUN messages may be blocked, the TURN server can be used in such cases.
- NAT traversal is always dependent on the Network policies adopted by that organization. Consult with the Network administrator for any configuration changes.
- If the STUN/TURN server requires authentication, it is recommended to use a HTTPS connection for this application.
- If the connection of conference with the system is disconnected the conference is closed.
- Standard SIP or Simple MCU is not supported.
- If user accesses the secondary system's URL when using NetLink, the system displays an error.
- There is a possibility that after a browser upgrade this feature becomes unusable.
- Thin Client PC is not supported.
- When using HTTPS connection, a security warning of server certificate is displayed if user accesses SV9100 by IP address or NetBIOS name, which is not default.
- The URL Copy button is not supported on the Android operating system with Version 4000 or lower.
- With Version 5000 or higher, the URL Copy button is supported with Android operating system.
- If the Android operating system does not support NetBIOS, then accessing with NetBIOS name will not work.
- If multiple terminals have the same NetBIOS name, then accessing with NetBIOS name may not work.
- With Chrome 47 or higher, an HTTPS connection must be used for Audio and Video support to be enabled.
- For screen sharing, installation of Chrome extension and HTTPS connection is required. The chrome extension can be downloaded from the Chrome Web Store using the following URL: <https://chrome.google.com/webstore/detail/dddkgjbmganocogdlemehnehmpodgij>
- Screen sharing can be used if camera is not connected.
- Screen Sharing is not supported with Internet Explorer.
- In Windows 8.1/10 systems, screen sharing does not function if sharing window is minimized.
- If a Conference URL is opened using Internet Explorer without the Temasys WebRTC Plugin installed, the error message **This Web Browser/OS is not supported** is displayed. Also, a message pops up stating, **This website requires you to install the Temasys WebRTC Plugin to work on this browser.**

- Pinch zoom on Android platform is not supported.

### Default Settings

None

## System Availability

### Terminals

None

### Required Component(s)

- GCD-CP10 or GPZ-IPLE
- CPU or VOIPDB Ethernet can be used
- 0414 – SV9100 Version Lic (R4)
- 0080 – SV9100 Web Video Conf
- Web Browser – Google Chrome v42 or higher, Internet Explorer 11 is supported with Version 5000 or higher
- 0415 – SV9100 Version Lic, required for STUN/TURN Server support
- Temasys WebRTC Plugin (latest version) – required to use this feature with Internet Explorer 11. Temasys WebRTC Plugin can be downloaded from following link: <https://temasys.atlassian.net/wiki/display/TWPP/Downloading+and+Installing>

### Supported Platforms

- Windows

Operating System – Windows 7, 8 or 8.1 (32- or 64-bit), Windows 10 (32- or 64-bit) is supported with Version 5000 or higher

Web Browser – Google Chrome v42 or later, Internet Explorer 11 is supported with Version 5000 or higher

- Android

Operating system – Android v 4.4.2 or later

Web Browser – Google Chrome v42 or later

Table 2-147 Recommended Client Device Specifications

Hardware	Specification
<b>Windows</b>	
CPU	Core i5 2.7GHz or more
RAM	4GB or more
<b>Android</b>	
CPU	Quad-core 2.5GHz or more
RAM	3GB or more

➤ If client devices do not meet recommended specifications, delays or disturbances may occur in video conference.

The following is an example of bandwidth utilization based on the number of conference participants and the above Hardware requirements:

Table 2-148 Hardware Specifications

Hardware	Specification
CPU	Intel® Core™ i5-3340M 2.70GHz
Memory	4.00GB
Camera	Logicool® c920t (Full HD 1080p)
Browser	Google Chrome v43.0.2357.130m

Table 2-149 Example of Bandwidth Utilization

MBit/Sec	Stream	Audio (Send)	Audio (Receive)	Video (Send)	Video (Receive)	Total without ScreenShare	ScreenShare (Send)	ScreenShare (Receive)	Total with both ScreenShare
2 person	0.069	0.031	0.031	2.152	2.125	4.435	1.471	1.471	7.377
3 person	0.138	0.062	0.062	4.304	4.304	8.870	2.942	2.942	14.754
4 person	0.207	0.093	0.093	6.456	6.456	13.305	4.413	4.413	22.131
5 person	0.276	0.124	0.124	8.608	8.608	17.740	5.884	5.884	29.508
6 person	0.345	0.155	0.155	10.76	10.76	22.175	7.355	7.355	36.885
7 person	0.414	0.186	0.186	12.912	12.912	26.610	8.826	8.826	44.262
8 person	0.483	0.217	0.217	15.064	15.064	31.045	10.927	10.927	51.639

## Related Features

None

## Guide to Feature Programming

The **Level 1**, **Level 2** and **Level 3** columns indicate the programs that are assigned when programming this feature in the order they are most commonly used. These levels are used with PCPro and WebPro wizards for feature programming.

- Level 1 – these are the most commonly assigned programs for this feature.
- Level 2 – these are the next most commonly assigned programs for this feature.
- Level 3 – these programs are not often assigned and require an expert level working knowledge of the system to be properly assigned.

Program Number	Program Name/Description	Input Data	Default	Level		
				1	2	3
10-12-01	<b>GCD-CP10 Network Setup – IP Address</b> Assign the IP Address.	0.0.0.0 ~ 126.255.255.254 128.0.0.1 ~ 191.255.255.254 192.0.0.1 ~ 223.255.255.254	192.168.0.10	✓		
10-12-02	<b>GCD-CP10 Network Setup – Subnet Mask</b> The setting of Subnet Mask is invalid when all Host Addresses are 0. If the network section is: 0, 127, 128.0, 191.255, 192.0.0, 223.255.255 The setting of Subnet Mask is invalid.	128.0.0.0   192.0.0.0   224.0.0.0  240.0.0.0   248.0.0.0   252.0.0.0  254.0.0.0   255.0.0.0  255.128.0.0   255.192.0.0   255.224.0.0   255.240.0.0  255.248.0.0   255.252.0.0  255.254.0.0   255.255.0.0   255.255.128.0   255.255.192.0  255.255.224.0   255.255.240.0  255.255.248.0   255.255.252.0  255.255.254.0   255.255.255.0   255.255.255.128  255.255.255.192  255.255.255.224  255.255.255.240  255.255.255.248  255.255.255.252  255.255.255.254  255.255.255.255	255.255.255.0		✓	
10-12-03	<b>GCD-CP10 Network Setup – Default Gateway</b> Assign the default gateway IP address for the GCD-CP10.	0.0.0.0 ~ 126.255.255.254 128.0.0.1 ~ 191.255.255.254 192.0.0.1 ~ 223.255.255.254	0.0.0.0		✓	
10-12-09	<b>GCD-CP10 Network Setup – IP Address</b> Set IP address for GPZ-IPLC. ➤ The IP Address assigned in Program 10-12-01 cannot start with the same leading digits as the IP Address assigned here.	0.0.0.0 ~ 126.255.255.254 128.0.0.1 ~ 191.255.255.254 192.0.0.1 ~ 223.255.255.254	172.16.0.10	✓		



Program Number	Program Name/Description	Input Data	Default	Level		
				1	2	3
10-12-10	<b>GCD-CP10 Network Setup – Subnet Mask</b> Set the subnet mask of the GPZ-IPL.	128.0.0.0   192.0.0.0   224.0.0.0  240.0.0.0   248.0.0.0   252.0.0.0  254.0.0.0   255.0.0.0  255.128.0.0   255.192.0.0  255.224.0.0   255.240.0.0  255.248.0.0   255.252.0.0  255.254.0.0   255.255.0.0  255.255.128.0   255.255.192.0  255.255.224.0   255.255.240.0  255.255.248.0   255.255.252.0  255.255.254.0   255.255.255.0  255.255.255.128  255.255.255.192  255.255.255.224  255.255.255.240  255.255.255.248  255.255.255.252  255.255.255.254  255.255.255.255	255.255.0.0	✓		
10-62-01	<b>NetBIOS Setting – NetBIOS Mode</b> Enable/Disable NetBIOS mode.	0 = Disable 1 = Enable	1	✓		
10-62-02	<b>NetBIOS Setting – NetBIOS Name</b> Assign NetBIOS name.	Maximum of 15 characters	SV9100	✓		
20-57-01	<b>UC User Information Settings – User ID</b> For each User Information Table number (1-128), define the User ID for authentication while creating a conference.	Maximum of 16 characters	No Setting	✓		
20-57-02	<b>UC User Information Settings – Password</b> For each User Information Table number (1-128), define the password for authentication while creating a conference.	Maximum of 16 characters	No Setting	✓		
20-64-01	<b>UC Web Application Setting – Web Conference Duration Timer</b> Define the maximum duration (seconds) for web conference (0 = no limit).	0 ~ 64800 seconds	7200	✓		
20-64-02	<b>UC Web Application Setting – Web Conference Duration Timer</b> Define the time duration (seconds) before the End Alert of the Web Conference should be displayed.	0 ~ 64800 seconds	300	✓		
20-66-01	<b>STUN/TURN Server Setting – Server Type</b> Define the server type as Disable, STUN or TURN.	0 = Disable 1 = STUN 2 = TURN	0	✓		
20-66-02	<b>STUN/TURN Server Setting – IP Address/Server Name</b> Define the IP address or server name.	Maximum of 128 characters	No Setting	✓		
20-66-03	<b>STUN/TURN Server Setting – Port Number</b> Define the server port number.	0 ~ 65535	3478	✓		

Program Number	Program Name/Description	Input Data	Default	Level		
				1	2	3
20-66-04	<b>STUN/TURN Server Setting – Authentication Name</b> Set the authentication name if the server needs authentication, otherwise leave blank.	Maximum of 32 characters	No Setting		✓	
20-66-05	<b>STUN/TURN Server Setting – Password</b> Set the password if the server needs authentication, otherwise leave blank.	Maximum of 32 characters	No Setting		✓	
90-54-01	<b>PC/Web Programming – WebPro TCP Port Number</b> Assign TCP WebPro port number.	0 ~ 65535	80	✓		
90-54-03	<b>PC/Web Programming – Web Programming TCP Port (HTTPS)</b> Assign Web programming TCP port (HTTPS) number.	0 ~ 65535 0 = HTTP access is not available	443	✓		

## Operation

### Login:

1. Access the following URL using the web browser: (<http://[System-URL (IP address or NetBIOS Name) ]/uc/> or <https://[System-URL (IP address or NetBIOS Name) ]/uc/> ).
2. Enter the User ID and Password defined in Programs 20-57-01 and 20-57-02, then press **Login** (refer to [Figure 2-107 Login Screen](#)).

Figure 2-107 Login Screen

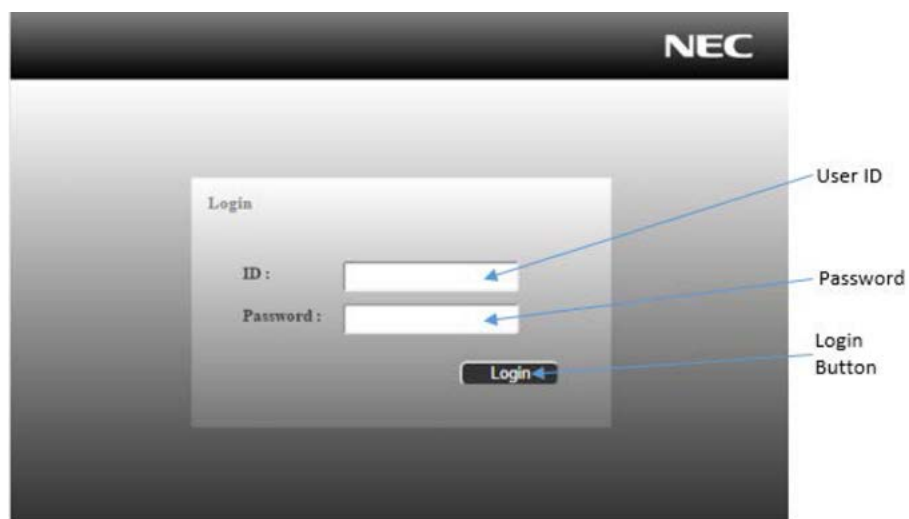

3. If authentication is successful, the conference creation screen is displayed (refer to [Figure 2-108 Video Conference Screen](#)).
  - ◇ An error message is displayed if an incorrect User ID or Password is entered.

Figure 2-108 Video Conference Screen

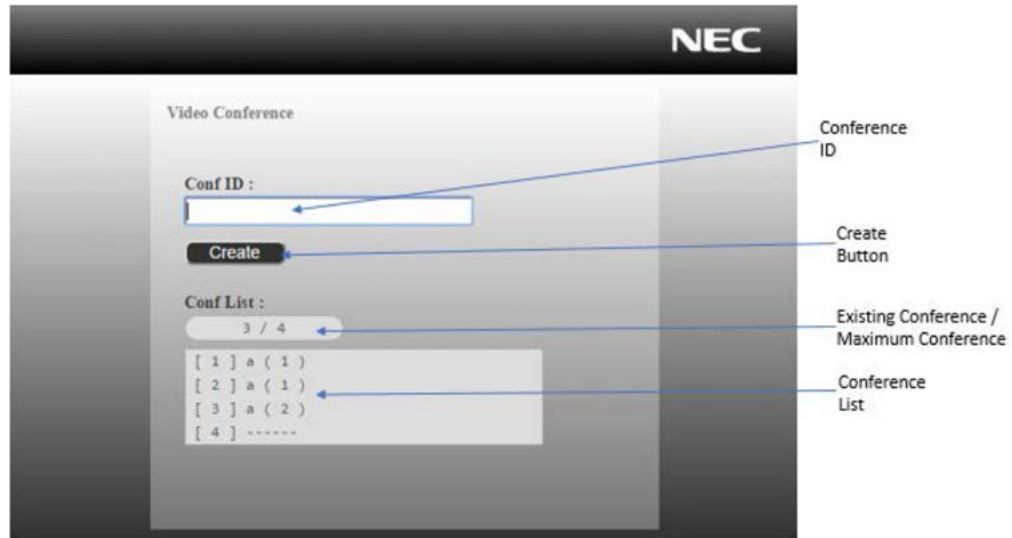

**Conference ID Creation:**

1. Enter the conference ID using a maximum of 32 alphanumeric characters and press **Create** (refer to [Figure 2-108 Video Conference Screen](#)).
2. Conf List displays existing conference/maximum conference. Serial number, organizer name and the number of participants in a conference is displayed. This list is updated in real time.
3. If the creation of conference is successful, the conference screen appears (refer to [Figure 2-109 Conference Screen with Conference ID](#)). This webpage asks permission to access the camera and MIC.
  - ◇ In case of a duplicated conference ID, any license issue, or if the web browser is not supported an error message is displayed.

Figure 2-109 Conference Screen with Conference ID

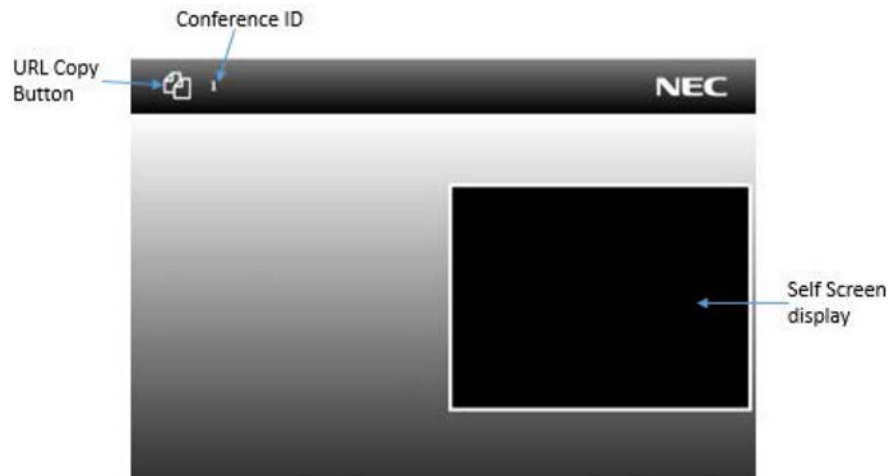

### Inviting and Participating:

1. The organizer can invite the participants by sharing the conference URL. The following are conference URL formats:  
 <http://System-URL/uc/conf?id=[Conference ID]> or  
 <https://System-URL/uc/conf?id=[Conference ID]>
2. To copy the URL, click on the **URL Copy Button** (refer to Figure 2-87 Conference Screen with Conference ID). The URL is copied to the clipboard. The organizer can share the same URL with participants. The URL is copied with the HTTPS option.
  - ◇ *With Version 4000 or lower, This button is not supported with the Android operating system.*
  - ◇ *With Version 5000 or higher, this button is supported with the Android Operating System.*
3. Participants can join the conference by accessing the shared conference URL using a web browser. When the participant accesses the conference, the conference screen is displayed with self and other's screen display. The webpage ask the permission to access the camera and MIC.
  - ◇ *If the number of participant reaches the maximum limit, an error message is displayed.*

### Conference:

1. After successful participation of a conference the following is displayed.
2. When a user joins the conference, the application will attempt to access the camera and MIC of the device. If user allows, then self-video along with the other participant's screen is displayed on the window and a P2P connection is established with other clients. If the user does not have a camera or MIC with the device or access is denied, then the user enters the conference as receive-only participant. The users are required to re-join the conference, if they want to connect a camera or a MIC.

- The browser can store the access permissions of conference users. If a user re-joins the conference, the browser may apply the previous permission rights.

Figure 2-110 Conference Screen with Toolbar

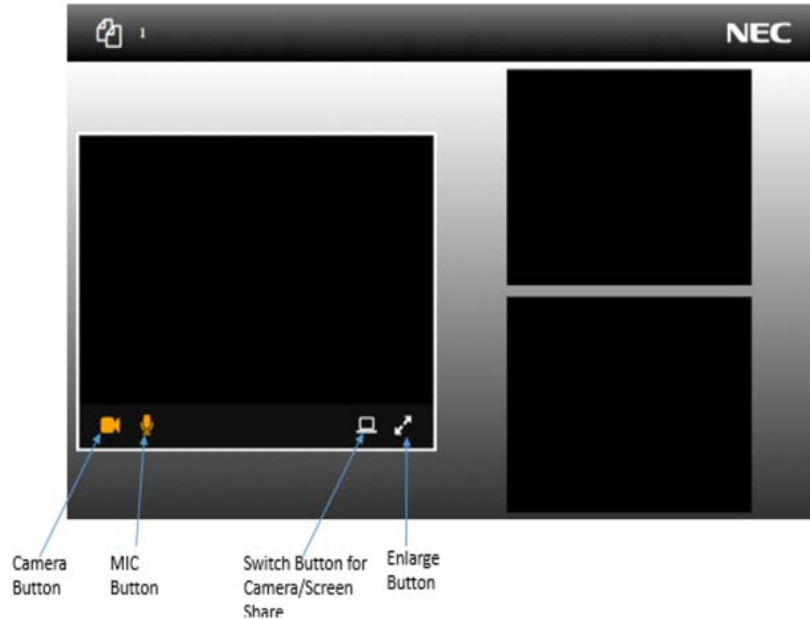

**Camera Button**

This button is displayed only on the self-screen. If the browser cannot access the camera this button is not displayed. This button is used to switch ON/OFF the transmission of video. When video transmission is off, this button appears white. A video off is indicated on the upper part of self-screen and no video illustration is displayed on other participant’s video. When video transmission is on, this button appears orange and the video off indicator disappears.

**Mic Button**

This button is displayed only on the self-screen. If the browser cannot access the MIC this button is not displayed. This button is used to switch ON/OFF the transmission of audio. When audio transmission is off, this button appears white and an audio off indicator is displayed on upper part of self and other participant’s screen. When audio transmission is on, this button appears orange and the audio off indicator disappears.

**Switch Button for Camera/Screen Share**

This button is only displayed on the self-video screen. This button is used to switch camera to screen share and vice-versa. While using screen share this button turns orange.

- ◇ *The Video Switching button is not displayed on Android systems, or if the connection is not made using HTTPS.*
- ◇ *The Video Switching button is not displayed with Internet Explorer as screen sharing is not supported with this browser.*
- ◇ *With Version 5000 or higher, if the Chrome extension for screen sharing is not installed and the Switch button is pressed, the installation page for this extension opens. Following installation, screen sharing is available.*

### Enlarge Button

This button is displayed on all video screens and is used to enlarge a particular video screen. Only one video can be enlarged at a time. When one video is enlarged the video bar of other video screens is not displayed. Various video screens in a conference are arranged per screen size and orientation. The drag and drop operation can also be used to rearrange the order of video screens except when the enlarge operation is used.

◇ *This drag and drop operation is not possible with Android operating systems.*

### Conference Exit:

Closing the webpage closes the conference for that user and video is disappeared from other user's displays.

### Release of Conference ID:

The Conference ID is released under following conditions:

- The number of participants becomes zero.
- The Web Conference Duration Timer expires.

If a conference URL is accessed after the conference ID is released, an error is displayed. As soon as the conference ID is released, it becomes available for re-use.

### Reloading the Webpage:

When a conference web-page is reloaded, it is considered as exiting and re-entering the conference. If a user reloads the webpage when no other user exists, the conference ID is released and the user cannot re-enter

### Forced Disconnect:

If the connection with the server is lost, all the conferences will be closed with an error. If any user is disconnected, the user is disconnected from the conference.

### Creating a Conference Without a Login:

With the following URL format user can directly create a conference by passing the login screen  
<https://[System URL]/uc/conf?id=[Conference ID]&u=[User ID]&p=[Password]>

### Duration Timer and End Alert Timer:

The SV9100 starts the web conference duration timer from the time when an organizer creates a conference. When the End Alert timer is not zero and is shorter than the Web Conference Duration timer then an End Alert is displayed as per Program 20-64-02 value before the Web Conference Duration timer expires. The warning alert asks if the conference needs to be continued or not. If yes is pressed then timers are reset and count starts again. When the End Alert timer is zero or is greater than Web conference duration timer then warning dialogue is not displayed. If the conference timer expires, then a time out error is displayed to all the participants and the conference is released.

**Screen Sharing:**

For screen sharing press the **Switch Button for Camera/Screen Share** (refer to [Figure 2-111 Switch Button for Video/Screen Sharing](#)).

*Figure 2-111 Switch Button for Video/Screen Sharing*

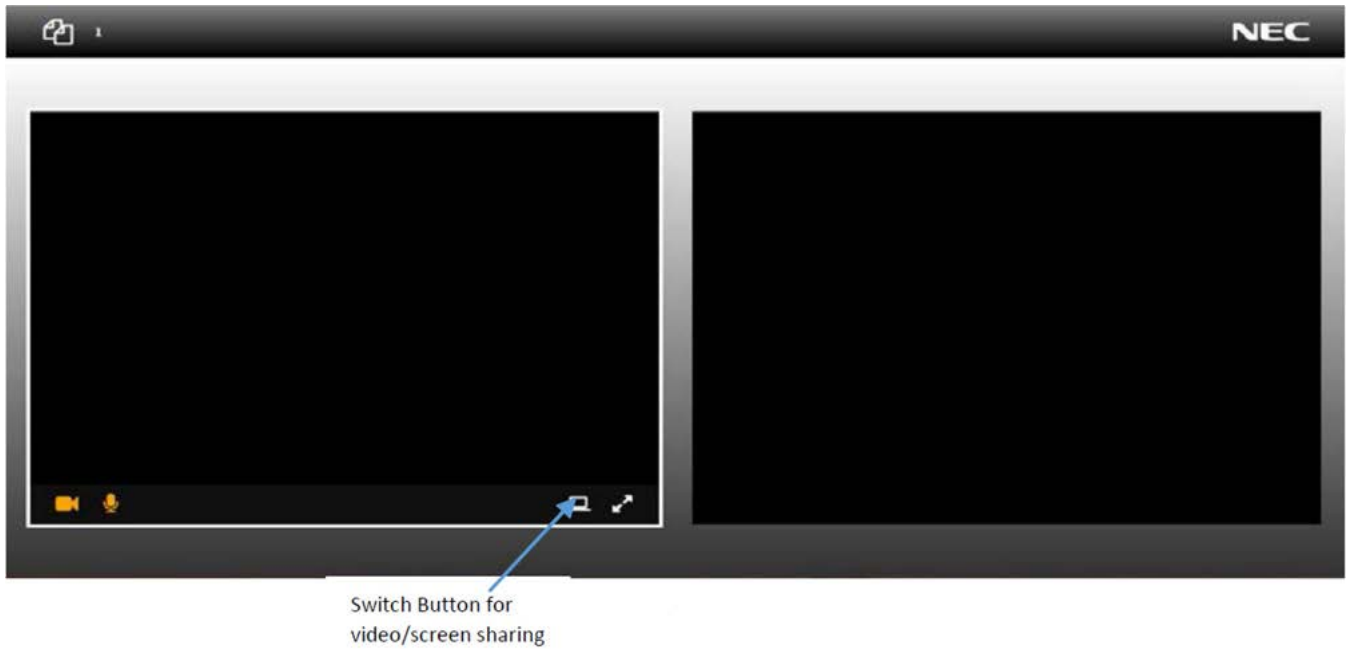

The following screen sharing option will be displayed. Select **Entire Screen** or particular application & press **Share** button on the NEC Screen Sharing window to share the screen with other user.

Figure 2-112 NEC Screen Sharing Window

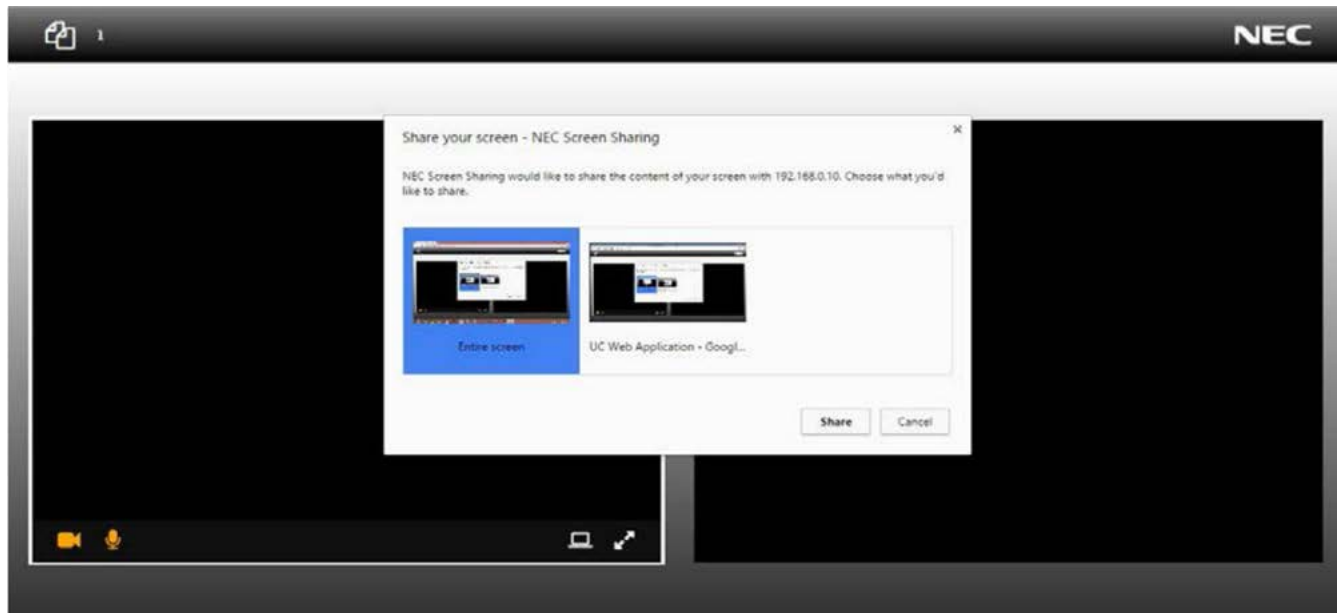

Screen will be shared with other users (refer to [Figure 2-113 Example of Users Sharing Window](#)).

Figure 2-113 Example of Users Sharing Window

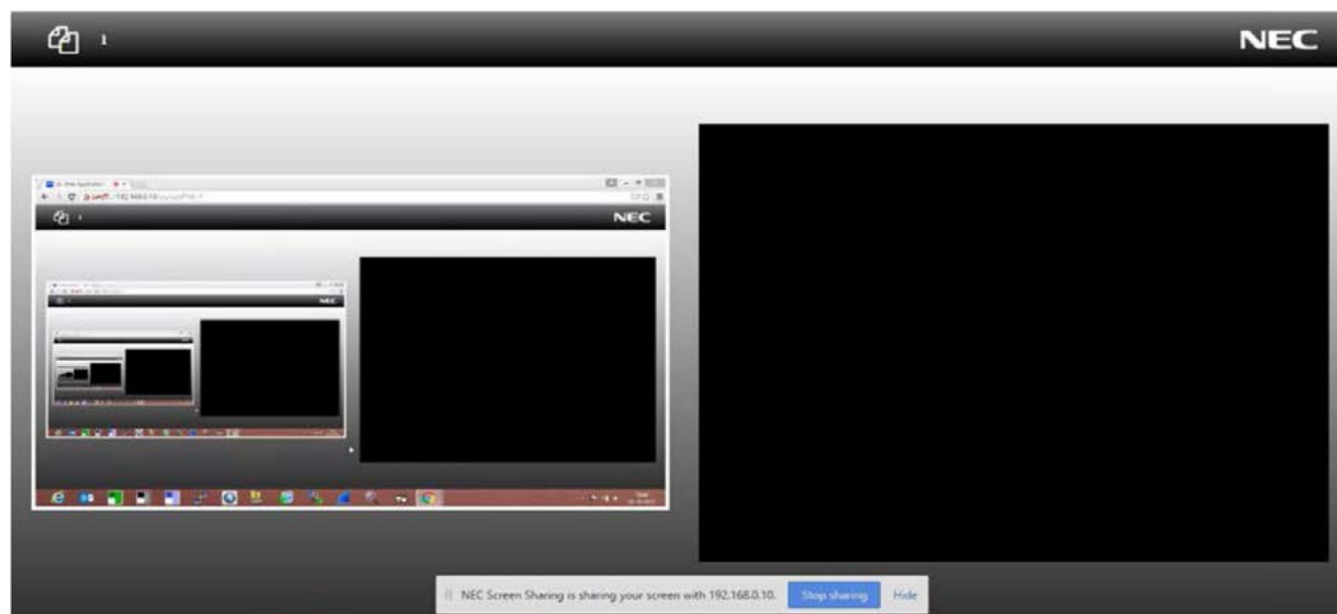



To stop screen sharing or switch back to camera, press the **Switch Button** or **Stop Sharing** button (refer to [Figure 2-114 Stop Screen Sharing or Camera Switch Window](#)).

Figure 2-114 Stop Screen Sharing or Camera Switch Window

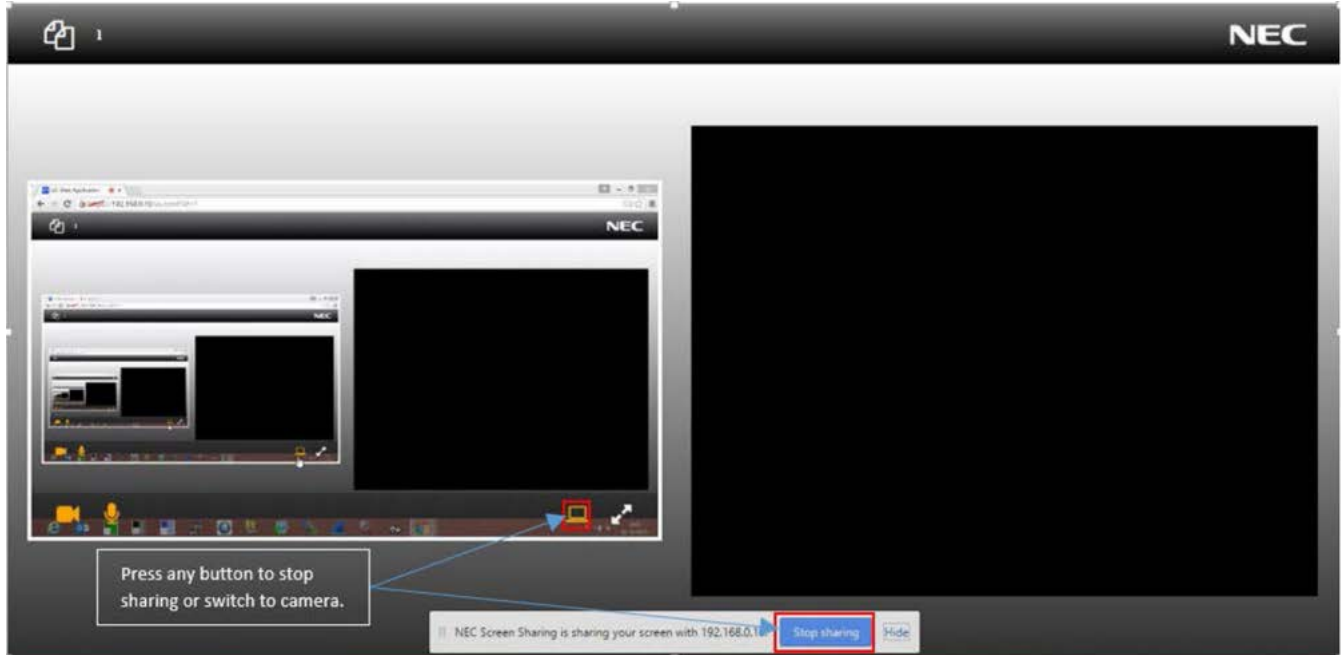

**Error List:**

[Table 2-150 Common Errors](#) lists the common errors displayed using the status and error conditions.

Table 2-150 Common Errors

Status	Error Condition	Displayed Messages
Loading	Non-supported browser or OS.	This Web Browser/OS is not supported.
Login	Error with User ID or password.	The user name/password combination is invalid.
Create	Conference ID is duplicated.	The conference ID is already in use.
	Conference error.	License capacity has been exceeded.
Join	Number of members has reached maximum.	The conference is full.
	Session license error.	License capacity has been exceeded.
Conference	Disconnected from SV9100.	Lost connection with the SV9100, the conference has ended.
	Web Conference Duration Timer (Program 20-64-01) is expired.	Web Conference Duration Timer has expired. The conference has ended.

[Table 2-151 Special Conditions](#) lists special conditions where the system returns a 204 No Content without displaying an error message to prevent external attacks.

*Table 2-151 Special Conditions*

Status	Error Condition
Login	Accessing the secondary system's URL in a NetLink system.
	R4 Version license is not installed.
Join	Accessing an invalid URL.
	Accessing the secondary system's URL in a NetLink system.
By-passing the Login	There is an error in User ID or Password.
	R4 Version license is not installed.

## Virtual Extensions

### Description

Virtual Extensions are available software extensions on the Basic and Expanded Port Packages. A Virtual Extension assigned to a line key can appear and ring on an individual station or multiple stations and be used for outbound access.

Virtual Extensions (VE) are shared with Call Arrival (CAR) Keys. In virtual extension mode, the key acts as a secondary extension. Up to 512 CAR/VE keys are provided.

### Conditions

- There are 512 available ports/Extensions shared between CAR keys and Virtual Extensions.
- The 512 available ports/Extensions are assigned per extension for CAR key mode or Virtual Extension key mode.
- More than one extension can share a Virtual Extension key.
- An extension can have more than one Virtual Extension key assigned.
  - ◇ *Assigning a Virtual Extension key of the extension the key is assigned on is not supported.*
- Up to 32 incoming calls can be queued to busy Virtual Extension key.
- You cannot have a CAR key and Virtual Extension on the same telephone.
- Virtual Extensions do not support the following features:
  - Barge-In
  - Conference
  - Conference, Voice Call/Privacy Release
  - Reverse Voice Over
  - Tone Override
  - Voice Over
- When a valid system station calls a Virtual Extension appearing on another station, Voice and MW softkeys appear in the display of the calling station, but they do not operate.
- When talking on a Virtual Extension you cannot mute the handset.
- Calls on Virtual Extension keys cannot be put in Personal Park if Program 15-18-01 is set to Land on the key (1).
- If multiple CAR/SIE/VE keys are ringing on a station at the same time, the CAR/SIE/VE key on the lowest Line Key is answered first.

- Virtual Extension Keys assigned as code \*03 do not support Voice Mail Message Indication on Line Keys.
- Busy Virtual Extensions cannot be Tone overridden.
- Class of service feature Program 20-11-20: No Call Back (transfer recall disable) is not supported for calls from a physical extension to a virtual extension.
- The system can be programmed to blink the page number of a DT300/DT700 DESI-Less terminal when it receives an incoming call, or switch to the page the incoming call is on. Also a default page can be defined for the DESI-Less terminal to change to when it goes idle or when it has answered a call.
- DESI-Less screen page switching only applies to idle terminals. If a terminal is not idle, the screen will not switch if another call comes in until the phone goes idle.
- When a call is parked from a virtual extension, the virtual extension is released.
- When parking a call from a virtual extension, Programs 15-02-21 and 15-18-01 must be set to 1.
- Park Group assignment is by terminal extension, not the virtual extension.
- When a call parked from a virtual extension recalls, it will ring the terminal where the virtual extension is programmed to, not the virtual extension key.
- When an internal station-to-station call is made to a virtual extension, the name and number of the calling party does not appear in the display of the station the virtual extension resides on until the call is answered.
- A door box cannot ring a virtual extension.
- If a user dials a number not programmed in ARS, Program 26-01-03 determines if the system should route over the trunk group settings defined in Program 21-02 or play an error tone.
- When using ARS Class of Service, with Program 26-01-03 set to (1) "Play Warning Tone", any trunk (except a CCIS trunk) pointed or transferred to a virtual that is Call Forward Off-Premise will not complete. For a virtual to Call Forward Off-Premise, Program 26-01-03 must be set to "Route to trunk group" and the call will follow the trunk group settings of the trunk, assigned in Program 21-03.
- When using ARS Class of Service, with Program 26-01-03 set to (1) "Play Warning Tone", a CCIS trunk pointed or transferred to a virtual that is call forwarded off premise will always follow ARS Class 1 routing properties.
- Calls made from Virtual Extensions will show up in SMDR as calls made from the physical extension the VE resides on.
- Virtual Extension Ring Assignment (command 15-09) will follow the ring assignment for the Night Mode Group the virtual extension is assigned to (default Night Mode Group 1) and not the Night Mode Group of the keyset the virtual is appearing on.
- A special ringtone is provided when a pre-assigned extension places an Intercom call.

- With SV9100 software, distinctive ringing on VE is supported which can distinguish between external and internal calls. When Program 20-04-05 is set to “On”, an outside call to VE follows the trunk incoming ringtone configured in Program 22-03-01 and Program 15-02-02.
- The incoming ringtone from a pre-assigned extension (set in Program 15-01-13) is limited to calls to the actual extension, not the Virtual Extension. Incoming calls to the VE follows Program 15-08-1 settings.
- A virtual extension can display the caller ID of an internal caller (Callers station name is displayed, if station name is not available the extension number is displayed). Also, a virtual extension can now display the caller ID of an internal or external caller when the virtual is not set to ring (Previously the virtual extension must be set to ring or CID is not displayed).
- Call Forwarding for a Virtual Extension cannot be set from DISA.
- Caller ID is not supported when transferring to a virtual extension that is set to call forward both ring.
- For calls to queue to that virtual extension, Call Forward No Answer must be used.

### Default Settings

Extensions 201~299 are the default for CAR/VE.

## System Availability

### Terminals

All Multiline Terminals

### Required Component(s)

None

## Related Features

- ➔ [Call Arrival \(CAR\) Keys](#)
- ➔ [Call Waiting/Camp-On](#)
- ➔ [Secondary Incoming Extension](#)

## Guide to Feature Programming

The **Level 1**, **Level 2** and **Level 3** columns indicate the programs that are assigned when programming this feature in the order they are most commonly used. These levels are used with PCPro and WebPro wizards for feature programming.

- Level 1 – these are the most commonly assigned programs for this feature.
- Level 2 – these are the next most commonly assigned programs for this feature.
- Level 3 – these programs are not often assigned and require an expert level working knowledge of the system to be properly assigned.

Program Number	Program Name/Description	Input Data	Default	Level		
				1	2	3
11-04-01	<b>Virtual Extension Numbering</b> Assign Extension Number for the Virtual Extensions (1 ~ 512).	Maximum of eight digits.	Virtual Extension Port No. 1 ~ 99 = Virtual Extension Number 201 ~ 299 Virtual Extension Port No. 100 ~ 512 = No Setting	✓		
14-02-17	<b>Analog Trunk Data Setup – Sync. Ringing</b> Enable or Disable ringing per trunk.	0 = Disable 1 = Enable	1		✓	
15-01-01	<b>Basic Extension Data Setup – Extension Name</b> Define the extension/virtual extension name.	Maximum of 12 characters.	STA 101 = Ext 101 STA 102 = Ext 102, etc.		✓	
15-02-02	<b>Multiline Telephone Basic Data Setup – Trunk Ring Tone</b> Set the tone (pitch) of the incoming trunk ring for the extension port you are programming.	1 = High 2 = Medium 3 = Low 4 = Ring Tone 1 5 = Ring Tone 2 6 = Ring Tone 3 7 = Ring Tone 4 8 = Ring Tone 5	2		✓	
15-02-03	<b>Multiline Telephone Basic Data Setup – Extension Ring Tone</b> Set the tone (pitch) of the incoming extension call ring for the extension port you are programming. Also refer to Program 15-08.	1 = High 2 = Medium 3 = Low 4 = Ring Tone 1 5 = Ring Tone 2 6 = Ring Tone 3 7 = Ring Tone 4 8 = Ring Tone 5	8		✓	

Program Number	Program Name/Description	Input Data	Default	Level		
				1	2	3
15-02-21	<p><b>Multiline Telephone Basic Data Setup – Virtual Extension Access Mode (when idle Virtual Extension key pressed)</b></p> <p>Determine whether an extension Virtual Extension Key should be used as a DSS key to the extension and for receiving calls (0), answering incoming calls and ability to place outgoing ICM or CO calls (1), or just receiving incoming calls (2). If the key is used for outgoing calls, the extension number of the key must be a real extension or virtual extension number. When the extension number of the key is a real extension number, and the key is pressed, the real extension cannot be used.</p>	<p>Virtual Extension Key Mode</p> <p>0 = DSS</p> <p>1 = OTG (Outgoing)</p> <p>2 = Ignore</p>	2	✓		
15-02-30	<p><b>Multiline Telephone Basic Data Setup – Toll Restriction Class</b></p> <p>Assign if the phone uses the Toll Restriction class of the VE (0) or the Real Extension when making outbound calls from the VE.</p>	<p>0 = Vir. Ext. (Virtual Extension Class)</p> <p>1 = Real Ext. (Real Extension Class)</p>	1		✓	
15-07-01	<p><b>Programmable Function Keys</b></p> <p>Assign Virtual Extension function keys on Multiline telephones (code *03 + extension number).</p>	<p>Line Key 1 ~ 48</p> <p>0 ~ 99 (Normal Function Code 751 by default)</p> <p>*00 ~ *99 (Appearance Function Code) (Service Code 752 by default)</p>	Refer to the Programming Manual for default values.	✓		
15-08-01	<p><b>Incoming Virtual Extension Ring Tone Setup</b></p> <p>When an extension or a virtual extension is assigned to the function key on the key telephone, select the ring tone when receiving a call on that key.</p> <p>For CAR keys, only tone pattern 1 can be used. The remaining patterns are not checked with this feature.</p>	<p>0 = Tone Pattern 1</p> <p>1 = Tone Pattern 2</p> <p>2 = Tone Pattern 3</p> <p>3 = Tone Pattern 4</p> <p>4 = Incoming Ring Tone Extension</p> <p>5 = Tone Pattern 5</p> <p>6 = Tone Pattern 6</p> <p>7 = Tone Pattern 7</p> <p>8 = Tone Pattern 8</p>	0		✓	
15-09-01	<p><b>Virtual Extension Ring Assignment</b></p> <p>Individually program an extension Virtual Extension key(s) to either Ring or Not Ring.</p>	<p>Day Night/Mode: 1 ~ 8</p> <p>Ringling:</p> <p>0 = Not Ring</p> <p>1 = Ring</p>	0	✓		
15-10-01	<p><b>Virtual Incoming Extension Ring Tone Order Setup</b></p> <p>When two or more virtual extensions are set on a function key on the telephone, and the tone pattern by which the sound of each extension differs, the priority of ring sound is set up.</p>	<p>0 = Tone Pattern 1</p> <p>1 = Tone Pattern 2</p> <p>2 = Tone Pattern 3</p> <p>3 = Tone Pattern 4</p> <p>4 = Incoming Extension Ring Tone</p> <p>5 = Tone Pattern 5</p> <p>6 = Tone Pattern 6</p> <p>7 = Tone Pattern 7</p> <p>8 = Tone Pattern 8</p>	<p>Order 1 Pattern</p> <p>0 = Pattern 1</p> <p>Order 2 Pattern</p> <p>1 = Pattern 2</p> <p>Order 3 Pattern</p> <p>2 = Pattern 3</p> <p>Order 4 Pattern</p> <p>3 = Pattern 4</p>		✓	

Program Number	Program Name/Description	Input Data	Default	Level		
				1	2	3
15-11-01	<b>Virtual Extension Delayed Ring Assignment</b> Individually program an extension Virtual Extension key(s) for Delayed Ringing (1) or Immediate Ringing (0).	KY01 Mode 1: 0 = Immediate Ring 1 = Delayed Ring	0		✓	
15-18-01	<b>Virtual Extension Key Enhanced Options – Virtual Extension Key Operation Mode</b> Assign if a call to a VE Holds (1) on the VE or Releases to the phone that answered the VE.	0 = Release 1 = Land On the Key	0	✓		
15-18-02	<b>Virtual Extension Key Enhanced Options – Display Mode when pacing a call on Virtual Extension Key</b> Define if calls to or from a Virtual Extension Key display the Virtual Extension Key name or the name of the extension where it resides.	0 = Secondary Extension Name 1 = Actual Station Name	0		✓	
15-18-03	<b>Virtual Extension Key Enhanced Options – Show CLI</b> When set to a 0, the caller ID of a trunk call/ station call pointed to a virtual extension <b>will not</b> be displayed if the virtual extension is not set to ring. When set to a 1, the caller ID of a trunk call pointed to a virtual extension <b>WILL be</b> displayed if the virtual extension is not set to ring. Station calls to a virtual that is not assigned to ring will display the station name or number if Program 15-18-04 is set to a 1.	0 = No CLI info 1 = Show CLI info	0		✓	
15-18-04	<b>Virtual Extension Key Enhanced Options – Show Internal Caller Information</b> When set to a 0, internal calls to the virtual extension <b>will not</b> show the name or number of the extension that is calling. When set to 1, internal calls to the virtual extension <b>WILL</b> show the name or number of the extension that is calling if the virtual is assigned to ring or if Program 15-18-03 is set to a 1.	0 = Do not show 1 = Show	0		✓	
15-18-05	<b>Virtual Extension Key Enhanced Options – One Ring</b> When set to a 0, the virtual extension follows the normal ring cycle. When set to a 1, the virtual extension will only ring one time (the virtual extension must be first set to ring in Program 15-08).	0 = Normal Ring Cycle 1 = One Ring	0		✓	
15-25-01	<b>DESI-less Page Setup – Incoming Call Notify Event</b> Enable/Disable the ability of a DESI-Less terminal to blink the page number that has an incoming call on one of the keys.	0 = Disable 1 = Enable	1	✓		



Program Number	Program Name/Description	Input Data	Default	Level		
				1	2	3
15-25-02	<b>DESI-less Page Setup – Incoming Call Automatic Screen Switching</b> Enable/Disable the ability of a DESI-Less terminal to switch to the page that has an incoming call on one of the keys.	0 = Disable 1 = Enable	1	✓		
15-25-03	<b>DESI-less Page Setup – Idle Automatic Screen Switching</b> Define or Disable the page to be automatically displayed when a DESI-Less terminal becomes idle.	0 = Disable 1 = Display page 1 2 = Display page 2 3 = Display page 3 4 = Display page 4	0	✓		
15-25-04	<b>DESI-less Page Setup – Answer Automatic Screen Switching</b> Define or Disable the page to be automatically displayed when a DESI-Less terminal answers a call.	0 = Disable 1 = Display page 1 2 = Display page 2 3 = Display page 3 4 = Display page 4	0	✓		
20-02-19	<b>System Options for Multiline Telephones – Virtual Extension Mode</b> Set the mode of a virtual extension key that appears on a DSS console.	0 = No 1 = Yes	0		✓	
20-04-03	<b>System Options for Virtual Extensions – CAR/SIE/Virtual Extension Delay Interval</b> CAR Keys/SIE Keys/Virtual Extensions set for Delayed Ringing (see Program 15-11) ring the extension after this time.	0 ~ 64800 seconds	10		✓	
20-04-05	<b>System Options for Virtual Extensions – Ringtone Mode for Incoming to Virtual Extension</b> Assign distinctive ringtone to incoming Virtual extension.	0 = Off 1 = On	0		✓	
20-06-01	<b>Class of Service for Extensions</b> Assign the Extension to a Class of Service.	Day Night/Mode: 1 ~ 8 Class of Service of Extensions (1 ~ 15)	Extension port 101 = Class 15 All other extension port = Class 1		✓	
20-07-10	<b>Class of Service Options (Administrator Level) – Programmable Function Key Programming (Appearance Level)</b> Turn Off or On an extension user ability to program the Appearance function keys using Service Code 752.	0 = Off 1 = On	COS 1 ~ 15 = 1	✓		
20-10-08	<b>Class of Service Options (Answer Service) – Virtual Extension Off-Hook Answer</b> Turn Off or On an extension user ability to answer an incoming call on a Call Arrival (CAR)/Secondary Incoming Extension (SIE)/ Virtual Extension by lifting the handset.	0 = Off 1 = On	COS 1 ~ 15 = 1		✓	

Program Number	Program Name/Description	Input Data	Default	Level		
				1	2	3
20-13-27	<b>Class of Service Options (Supplementary Service) – Busy on Seizing Virtual Extension</b> If set to 1, you can call a busy extension which is talking on a virtual extension key. Program 20-13-06 (Call Waiting) must be Off for this option to work.	0 = Off 1 = On	COS 1 ~ 15 = 1		✓	
20-15-03	<b>Ring Cycle Setup – Incoming Internal Call</b> Define ringing cycle for incoming Internal calls.	1 ~ 13 - Ringing Cycle	12		✓	
21-01-15	<b>System Options for Outgoing Calls – Outgoing Disable on Incoming Line (Toll Restriction)</b> Enable/Disable the Outgoing Disable on Incoming Line feature.	0 = Disable 1 = Enable	0		✓	
22-03-01	<b>Trunk Ring Tone Range</b> Select the ring tone range for the trunk. The trunk uses a ring tone in the range selected when it rings an extension. Eight ring tones are available.	0 ~ 12 (Ring Tone Pattern 1 ~ 4) (Melody 1 ~ Melody 5) (Ring Tone Pattern 5 ~ 8)	0		✓	
23-04-01	<b>Ring Line Preference for Virtual Extensions</b> When an extension has a virtual extension on Function Key, this program determines the priority (1 ~ 4) for a Ring Group for automatically answering ringing calls when the handset is lifted. If (00) is selected for the Ring Group, when the handset is lifted, the user can answer a ringing call from any group.	00 ~ 64 (0 or 00 = Don't Care)	00		✓	

## Operation

### To answer a call ringing a Virtual Extension:

1. Press the flashing **Virtual Extension** key.
- OR -
- Go off-hook.
- ◇ *Program 20-10-08 needs to be set to on (1) for extension Class of Service.*

### To place a call to a Virtual Extension:

1. Go off-hook.
2. Dial the Virtual Extension, or press the **Virtual Extension** key.
- ◇ *The operation depends on the setting in Program 15-02-21.*

**To place a call from a Virtual Extension:**

1. Press the **Virtual Extension** key.
  - ◇ *The operation depends on the setting in Program 15-02-21.*
2. Place an intercom call or dial a trunk access code to seize an outside line and place your call.

**To program a Virtual Extension key on a telephone:**

1. Press **Speaker**.
2. Dial **752**.
3. Press the key you want to program.
4. Dial **\*03**.
5. Dial the number of the extension you want to appear on the key.
6. Press **Hold** once for Immediate Ring (skip to step 8 for Delayed Ring).
7. Dial the mode number in which the key rings.
  - 1 = Day 1
  - 2 = Night 1
  - 3 = Midnight 1
  - 4 = Rest 1
  - 5 = Day 2
  - 6 = Night 2
  - 7 = Midnight 2
  - 8 = Rest 2
8. Press **Hold** for a second time for Delayed Ring, or Skip to step 10.
9. Dial the mode number in which the key delay rings.
  - 1 = Day 1
  - 2 = Night 1
  - 3 = Midnight 1
  - 4 = Rest 1
  - 5 = Day 2
  - 6 = Night 2
  - 7 = Midnight 2
  - 8 = Rest 2
10. Press **Speaker**.

## Virtual Extensions – Incoming Call History

### Description

With Version 5000 or higher, Incoming Call History is saved for the ringing Virtual Extension as **OTH ANS** when call is answered by same virtual extension assigned on some other MLT.

Figure 2-115 Virtual Extension – Incoming Call History

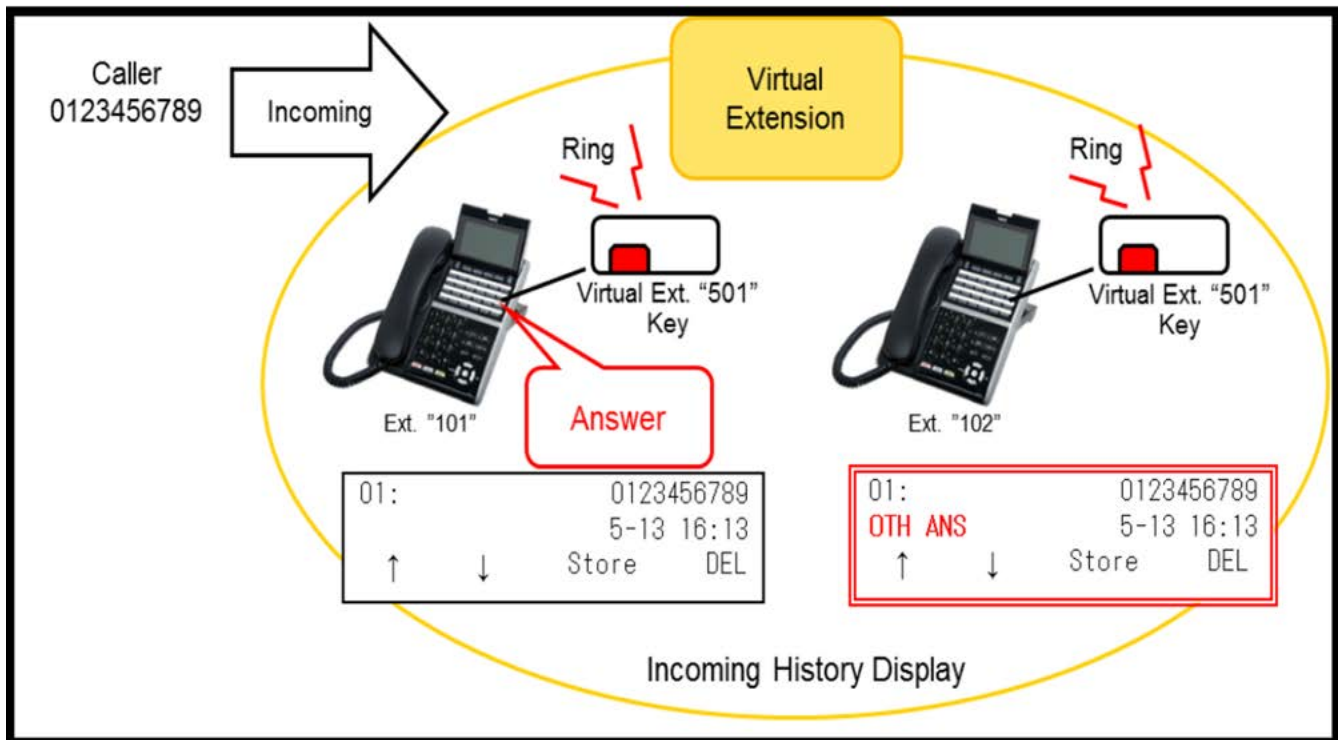

### Conditions

- When Program 15-18-03 is set to **1** (Show CLI info), Caller ID for VE Others Answer is stored even if the terminal does not ring.
- When Program 15-11-01 is set to **1** (Delayed Ring), the timing of saving Caller ID depends on the timer defined in Program 20-04-03.
  - ❑ When others answer before the timer defined in Program 20-04-03, Caller ID for VE Others Answer is not stored.
  - ❑ When others answer after the timer in Program 20-04-03, Caller ID for VE Others Answer is stored.
- Caller ID for VE Others Answer is supported on Normal, DID, DIL, DID Mode Switching trunks.

- Combination of ring setting, CLI and the timing at which Caller ID for VE Others Answer is saved:

Item	Program 15-09-01 Ring	Program 15-11-01 Delayed Ring	Program 15-18-03 Show CLI	Ring/No Ring	When Does OTH ANS Save
1	1	1	1	Ring	After the expiry of timer in Program 20-04-03
2	1	1	0	Ring	After the expiry of timer in Program 20-04-03
3	1	0	1	Ring	Immediately
4	1	0	0	Ring	Immediately
5	0	1	1	No Ring	After the expiry of timer in Program 20-04-03
6	0	1	0	No Ring	No Caller ID for VE Others Answer
7	0	0	1	No Ring	Immediately
8	0	0	0	No Ring	No Caller ID for VE Others Answer

- Caller ID for VE Others Answer (OTH ANS) is not supported, when a call is screened transfer to VE from InMail.
- In the case of Unscreened Transfer from InMail, Caller ID for VE Others Answer is not stored when other extension answered the call before Caller ID is displayed on the LCD.
- Caller ID for VE Others Answer is not stored on the terminals ringing as real extension assigned to the same incoming ring group as the VE.
- Caller ID for VE Others Answer is not stored when a trunk call is screened transferred from ICM call to VE.
- In the case of an unanswered transferred call from VE to VE, Caller ID for VE Others Answer is stored but Caller ID for missed call is also stored on the terminals that is ringing before transfer.
- If the extension number of ringing Virtual Extension Key is the real extension number, Incoming call history (OTH ANS) is not stored on the ringing terminals but Caller ID for others answered call is stored.
- When Program 15-02-15 is set to **0** (Disable), Caller ID for VE Others Answer is not stored.
- Caller ID for VE Others Answer is not stored on the terminal of a Multi-Device Group.
- Caller ID for VE Others Answer is not supported for intercom calls.
- Caller ID for VE Others Answer does not depend on Program 15-18-01. The Caller ID is stored when Program 15-18-01 is set to **0** (Release) or **1** (Land on the key).
- Caller ID for VE Others Answer is stored on the terminal that does not ring because of busy at the time of incoming call to VE.

- If an incoming call is received more than once from the same caller at the same time (date, hour and minute), only the first incoming call history is saved.
- In the case of OTH ANS, only nine letters of the Telephone Book Name and Speed Dial Name are displayed.
  - On DT400 Terminal 12 character name is displayed.
- "OTH ANS" is not displayed when Call History is accessed through Center Navigation Key.
- Caller ID for VE Others Answer (OTH ANS) is saved when UC suite is in Softphone mode.
- Incoming Call History can be accessed by programmable function key (08).

## Default Settings

None

## System Availability

### Terminals

All Multiline Terminals

### Required Component(s)

0415 – SV9100 Version Lic (R5)

## Related Features

None

## Guide to Feature Programming

The **Level 1**, **Level 2** and **Level 3** columns indicate the programs that are assigned when programming this feature in the order they are most commonly used. These levels are used with PCPro and WebPro wizards for feature programming.

- Level 1 – these are the most commonly assigned programs for this feature.
- Level 2 – these are the next most commonly assigned programs for this feature.
- Level 3 – these programs are not often assigned and require an expert level working knowledge of the system to be properly assigned.

Program Number	Program Name/Description	Input Data	Default	Level		
				1	2	3
15-02-15	<b>Multiline Telephone Basic Data Setup – Storage of Caller ID for Answered Call</b> Enable (1) or Disable (0) ability of extension to store Caller ID for answered calls.	0 = Disable 1 = Enable	1	✓		
15-07-01	<b>Programmable Function Keys</b> Assign Virtual Extension function keys on Multiline telephones (code *03 + extension number). Assign Incoming Caller ID list function key (08) to access the Call History.	Line Key 1 ~ 48 0 ~ 99 (Normal Function Code 751 by default) *00 ~ *99 (Appearance Function Code) (Service Code 752 by default)	Refer to the Programming Manual for default values.	✓		
20-02-28	<b>System Options for Multiline Telephones – Storage of Caller ID for VE Other Answer</b> Turn Off or On to save the history as "OTH ANS" for ringing VEs on other MLTs that have the same VE.	0 = Off 1 = On	0	✓		

## Operation

None

## Voice Call Recording

### Description

When using NEC DT300 and DT700 desktop terminals, telephone calls can be monitored, recorded and stored. For DT300 (TDM) terminals, the NEC 4-Port Digital Call Logging Unit – VSR (Voice Security Recorder) is used. For DT700 (IP) terminals, the NEC SonicView IP Recorder is used.

### *D<sup>term</sup>® Voice Security Recorder (VSR)*

### Description

The *D<sup>term</sup>®* Voice Security Recorder is a USB device that taps across the digital extension pair of the NEC telephone system allowing digital recording of the telephone user's conversation. The file created is saved either to the local PC or to a network location, depending on the application blade used. This adapter is for use with IP or digital multiline terminals. It cannot be used to record VoIP phone conversations in a Netlink or CCIS configuration.

Two options are available for playing back calls recorded by your VSR(s). The first is the Desktop Player which is used by an individual user to play back their own archive of calls or to play back NEC Dterm VSR calls stored on their PC or network. It easily manages calls from one storage location. It does not offer many of the advanced functions of the VSR Manager, such as establishing preset shortcuts to any number of storage folders for quick and easy access.

The second player option is the **VSR Manager**. Take your call recording environment to the next level with NEC VSR application software. **VSR Manager** provides advanced visibility, access, retrieval, and playback tools for the VSR Recorder administrators. It provides an intuitive interface for establishing shortcuts to any number of storage folders and allows the supervisor to search across all storage folders for specific call information such as User, Time/Date, Length of Call, etc. The application can be used to access and manage VSR recordings whether created by the single port VSR or the 4-Port Digital Call Logging Unit. **VSR Manager** is built on the robust Microsoft.net frame-work and manipulates large volumes of recordings. It is a workhorse that delivers truly feature rich productivity tools in a familiar, ergonomic and easy to use MS Office style interface.

These two players can be combined in any number of configurations in the company, providing control and management where needed and simple playback in other locations.



Refer to the documentation included with the *D<sup>term</sup>*® VSR (P/N 780275) for details on setting up and using the Desktop Player.



*The use of monitoring, recording, or listening devices to eavesdrop, monitor, retrieve, or record telephone conversation or other sound activities, whether or not contemporaneous with transmission, may be illegal in certain circumstances under federal or state laws. Legal advice should be sought prior to implementing any practice that monitors or records any telephone conversation. Some federal and state laws require some form of notification to all parties to a telephone conversation, such as using a beep tone or other notification methods or requiring the consent of all parties to the telephone conversation, prior to monitoring or recording the telephone conversation. Some of these laws incorporate strict penalties.*

## Conditions

- The PC hosting Back Office should have the power save functionality turned off.
- Encryption is only supported at 256-bit setting.
- Does not support recording of VoIP phone conversations in a Netlink or CCIS configuration.
- No Wireless terminal support.
- Encryption Feature – Requires VSR Manager or VSR Reporter for playback.
- Network Port monitoring for IP Extensions.
- Peer to Peer not supported.
- VoIP calls placed on hold or conference will break into two call recordings.
- DTerm Voice Security Recorder (VSR) cannot record if the recording option within the VSR Recorder software is set to record incoming calls only.

## Default Settings

None

## System Availability

### Terminals

NEC DT300/DT700 Series Desktop Terminals – *D<sup>term</sup>*® VOICE SECURITY RECORDER (VSR)

### Required Component(s)

- 4-Port Digital Call Logging Unit
- PC Hardware and Software:

#### 4-Port Digital Call Logging Unit

- Pentium 4 processor
- 512 Mb RAM
- One USB Controller Card for each four devices – powered USB hubs can be used however, no more than four devices should be connected to a USB Controller Card
- An available PCI slot for each USB Controller Card
- LAN connection for remote access to stored calls
- NEC BackOffice Recorder software
- Supported Operating Systems:
  - Windows XP
  - Windows 7

## Related Features

None

## Guide to Feature Programming

The **Level 1**, **Level 2** and **Level 3** columns indicate the programs that are assigned when programming this feature in the order they are most commonly used. These levels are used with PCPro and WebPro wizards for feature programming.

- Level 1 – these are the most commonly assigned programs for this feature.
- Level 2 – these are the next most commonly assigned programs for this feature.
- Level 3 – these programs are not often assigned and require an expert level working knowledge of the system to be properly assigned.

Program Number	Program Name/Description	Input Data	Default	Level		
				1	2	3
14-02-10	<b>Analog Trunk Data Setup – Caller ID</b> Enable/Disable a trunk ability to receive Caller ID information.	Trunks 1 ~ 400 0 = No 1 = Yes	0	✓		
15-03-10	<b>Single Line Telephone Basic Data Setup – Caller ID Name</b> Determine whether or not a single line telephone should display the Caller ID name.	0 = Disable 1 = Enable	1	✓		

Program Number	Program Name/Description	Input Data	Default	Level		
				1	2	3
20-08-15	<p><b>Class of Service Options (Outgoing Call Service) – Block Outgoing Caller ID</b></p> <p>Turn Off or On a user Class of Service from automatically blocking outgoing Caller ID information when a call is placed. If block is enabled, the system automatically inserts the Caller ID block code *67 (defined in Program 14-01-21) before the user dialed digits (this requires Program 14-02-10 to be enabled). If block is disabled, the system outdials the call just as it was dialed by the user.</p>	<p>0 = Off 1 = On</p>	COS 1 ~ 15 = 0		✓	
20-09-02	<p><b>Class of Service Options (Incoming Call Service) – Caller ID Display</b></p> <p>Turn Off or On the Caller ID display at an extension.</p>	<p>0 = Off 1 = On</p>	COS 1 ~ 15 = 0	✓		
20-19-01	<p><b>System Options for Caller ID – Caller ID Displaying Format (If displaying digits are more than 12 digits)</b></p> <p>Determine whether the first 10 digits or last 10 digits should be displayed when Caller ID exceeds 12 digits.</p>	<p>0 = First 10 digits (Upper) 1 = Last 10 digits (Lower)</p>	0		✓	

## Operation



Refer to the *UNIVERGE SV9100 System Hardware Manual, Chapter 11, Section 11 Dterm® Voice Security Recorder (VSR)* for detailed information.

# NEC SonicView™ IP Recorder (1.0)

## Description

The NEC SonicView™ IP Recorder application is an easy-to-use yet powerful web-based call recording solution. The SonicView software offers robust features designed specifically for business users who want to make use of Enterprise call data for reporting, analysis and monitoring. The different components that make up the SonicView application are:

- Application Server
- Database Server
- Recording Engine
- Network Infrastructure to Enable Call Recording

## Web Server

The SonicView application uses the Apache Tomcat server as a web container, or web server. Apache Tomcat implements the necessary Java Servlet and Java Server Pages (JSP) specifications from Sun Microsystems. Thus, providing an environment for the SonicView application to run in conjunction with a web server. It adds tools for configuration and management but can also be configured by editing configuration files that are normally XML-formatted. Tomcat includes its own internal HTTP server.



REFERENCE

*Refer to the NEC IP Recorder SonicView User Guide and Installation Manual located on the AK System PC Apps CD (P/N 670830) for additional Information.*

## Database Server

The SonicView application uses PostgreSQL server as the database server for storing all the call information captured from the network. The PostgreSQL database server can be implemented in a straightforward manner as a separate node (on a network) dedicated to running database-management software. This node provides an interface to client nodes (the end users of the SonicView application) such that the same data is accessible to all nodes. The SonicView application interface allows users to submit requests to the database server and retrieve call information. The database server manages the processor-intensive work such as data manipulation, compilation, and optimization. It then, sends only the final results back to the SonicView application.

Refer to the NEC IP Recorder SonicView User Guide and Installation Manual located on the AK System PC Apps CD (P/N 670830) for additional Information.

## Recording Engine

The SonicView application uses the recording engine component to sniff and record all call information captured from the network. Typically, the recording engine should be installed on a server class machine with a network card that interfaces with a managed switch. After installing the SonicView application using the setup CD, the recording engine will not record any VoIP calls by default. To make this happen, you must ensure that the necessary network infrastructure and configurations are in place. For a detailed description of the network infrastructure required for call capture, refer to the Network Infrastructure section.

To make the necessary configurations on the recording engine to enable call capturing, refer to Configuring the Recorder subsection under the Administrative tasks section.

Refer to the NEC IP Recorder SonicView User Guide and Installation Manual located on the AK System PC Apps CD (P/N 670830) for additional information.

## SonicView On-Demand Recording (ODR) Client

The SonicView On-Demand Recording client is a convenient tool to record and view calls as they happen in real-time. This standalone desktop application can be downloaded and installed from the login page of the main application. For instructions to download and install this client, refer to the NEC IP Recorder SonicView installation and configuration guide.



*The use of monitoring, recording, or listening devices to eavesdrop, monitor, retrieve, or record telephone conversation or other sound activities, whether or not contemporaneous with transmission, may be illegal in certain circumstances under federal or state laws. Legal advice should be sought prior to implementing any practice that monitors or records any telephone conversation. Some federal and state laws require some form of notification to all parties to a telephone conversation, such as using a beep tone or other notification methods or requiring the consent of all parties to the telephone conversation, prior to monitoring or recording the telephone conversation. Some of these laws incorporate strict penalties.*

## Conditions

- NEC IP Recorder SonicView - The PC hosting the recording engine component should be on the same subnet as the PBX for it to capture calls. Unless this configuration is made, no calls will be recorded.
- NEC IP Recorder Sonic View - A Vista “Master Administrator” account (“Administrator”) is required to install the application. The user must enable the Vista Master Administrator account and log into this account to perform the installation. The Apache Tomcat web server, Apache Derby Database server and Recording Engine will not be installed correctly in non-master administrator accounts.
- NEC IP Recorder Sonic View - A single-/multi-port managed switch with port mirroring setup is mandatory to enable call capturing over the network. The server hosting the recording engine should be connected to a managed switch (customer provided) such that the PBX’s traffic mirrored to the port on which the recording engine server is connected.

## Default Settings

Not Installed

## System Availability

### Terminals

NEC DT700 (IP) Terminals – NEC SonicView IP Recorder

### Required Component(s)

- Hardware:
  - Pentium 1.8 GHz core 2 duo or above
  - 4 GB RAM
  - 250 GB of free hard disk space (30000 hours of continuous recording)
  - SVGA monitor 1024 X 768 resolution
  - Network Interface Card (NIC)
- Supported Operating Systems:
  - Windows Server 2003 with SP2
  - Windows Vista Business Edition with SP1
  - Windows XP Professional with SP3
- Recording Server Requirements
  - Hardware:
    - Pentium 1.6 GHz core 2 duo
    - A minimum of 2 GB RAM
    - 250 GB of free hard disk space (30000 hours of continuous recording)
    - SVGA monitor 1024 X 768 resolution
    - Network Interface Card (NIC)
  - Supported Operating Systems:
    - Windows Server 2003 with SP2
    - Windows Vista Business Edition with SP1
    - Windows XP Professional with SP3
- Application and Recording Server Requirements (both features on same server)
  - Hardware:
    - Pentium 2.66 GHz core 2 duo

- A minimum of 4 GB RAM
- 250 GB of free hard disk space (30000 hours of continuous recording)
- SVGA monitor 1024 X 768 resolution
- Network Interface Card (NIC)
- Supported Operating Systems:
  - Windows Server 2003 with SP2
  - Windows Vista Business Edition with SP1
  - Windows XP Professional with SP3
- Client Side Requirements:
  - Pentium 4 class machine
  - A minimum of 512 MB RAM
  - SVGA monitor 1024 X 768 resolution
  - Adobe® Flash® player plug-in version 9 or above
  - Adobe® Acrobat Reader® 7 or above (if client needs to view/edit reports)
  - Microsoft Excel 2000 (if client needs to view/edit reports)
- Supported Internet Browsers:
  - Microsoft Internet Explorer 7 and above
  - Mozilla® Firefox® version 2.0 or above
  - Google™ Chrome
- SV9100 CPU License (NEC IP Recorder SonicView)

Table 2-152 IP Recorder Basic Licenses

670863 LKS-IP Recorder Basic Pkg-LIC		
Feature Code	Quantity Included	Comments
3200	4 Stations 1 Supervisor 4 ODRs (On-Demand Recording)	Provides the ability to have four stations, one Supervisor and up to four On-Demand Recording clients.
670864 LKS-IP Recorder Basic Port Add-on 4-LIC		
Feature Code	Quantity Included	Comments
3202	4 Additional Stations	Provides the ability to record four additional stations over the initial four received with 670863.
670865 LKS-IP Recorder Basic Port Add-on 1-LIC		
Feature Code	Quantity Included	Comments
3202	1 Additional Station	Provides the ability to record one additional station over the initial four received with 670863.

Table 2-152 IP Recorder Basic Licenses (Continued)

67082 LKS-IP Recorder Basic SUPV Add-on 1-LIC		
Feature Code	Quantity Included	Comments
3201	1 Additional Supervisor	Provides one additional Supervisor Login.

## Related Features

None

## Guide to Feature Programming

The **Level 1**, **Level 2** and **Level 3** columns indicate the programs that are assigned when programming this feature in the order they are most commonly used. These levels are used with PCPro and WebPro wizards for feature programming.

- Level 1 – these are the most commonly assigned programs for this feature.
- Level 2 – these are the next most commonly assigned programs for this feature.
- Level 3 – these programs are not often assigned and require an expert level working knowledge of the system to be properly assigned.

Program Number	Program Name/Description	Input Data	Default	Level		
				1	2	3
14-02-10	<b>Analog Trunk Data Setup – Caller ID</b> Enable/Disable a trunk ability to receive Caller ID information.	Trunks 1 ~ 400 0 = No 1 = Yes	0	✓		
15-03-10	<b>Single Line Telephone Basic Data Setup – Caller ID Name</b> Determine whether or not a single line telephone should display the Caller ID name.	0 = Disable 1 = Enable	1	✓		
15-05-50	<b>IP Telephone Terminal Basic Data Setup – Peer to Peer Mode</b> On a per station basis enable or disable Peer to Peer mode.	0 = Disable 1 = Enable	1	✓		
20-08-15	<b>Class of Service Options (Outgoing Call Service) – Block Outgoing Caller ID</b> Turn Off or On a user Class of Service from automatically blocking outgoing Caller ID information when a call is placed. If block is enabled, the system automatically inserts the Caller ID block code *67 (defined in Program 14-01-21) before the user dialed digits (this requires Program 14-02-10 to be enabled). If block is disabled, the system outdials the call just as it was dialed by the user.	0 = Off 1 = On	COS 1 ~ 15 = 0		✓	



Program Number	Program Name/Description	Input Data	Default	Level		
				1	2	3
20-09-02	<b>Class of Service Options (Incoming Call Service) – Caller ID Display</b> Turn Off or On the Caller ID display at an extension.	0 = Off 1 = On	COS 1 ~ 15 = 0	✓		
20-19-01	<b>System Options for Caller ID – Caller ID Displaying Format (If displaying digits are more than 12 digits)</b> Determine whether the first 10 digits or last 10 digits should be displayed when Caller ID exceeds 12 digits.	0 = First 10 digits (Upper) 1 = Last 10 digits (Lower)	0		✓	

## Operation



REFERENCE

- Refer to the *SonicView User Guide* for operational details.
- Refer to the following manuals for detailed information regarding the *NEC SonicView IP Recorder*:
  - *NEC SonicView IP Recorder Installation and Setup Guide*
  - *NEC SonicView IP Recorder Application User Guide*

## NEC SonicView Recorder (TDM and IP) (2.0)

### Description

The NEC SonicView™ Recorder application is an easy-to-use yet powerful web-based call recording solution use for both IP and TDM calls. The SonicView software offers robust features designed specifically for business users who want to make use of Enterprise call data for reporting, analysis and monitoring. The different components that make up the SonicView application are:

- Application Server
- Database Server
- Recording Engine
- Network Infrastructure to Enable Call Recording

### Web Server

The SonicView application uses the Apache Tomcat server as a web container, or web server. Apache Tomcat implements the necessary Java Servlet and Java Server Pages (JSP) specifications from Sun Microsystems. Thus, providing an environment for the SonicView application to run in conjunction with a web server. It adds tools for configuration and management but can also be configured by editing configuration files that are normally XML-formatted. Tomcat includes its own internal HTTP server.



*Refer to the NEC SonicView Recorder User Guide and Installation Manual located on the AK System PC Apps CD (P/N 670830) for additional Information.*

### Database Server

The SonicView application uses PostgreSQL server as the database server for storing all the call information captured from the network. The PostgreSQL database server can be implemented in a straightforward manner as a separate node (on a network) dedicated to running database-management software. This node provides an interface to client nodes (the end users of the SonicView application) such that the same data is accessible to all nodes. The SonicView application interface allows users to submit requests to the database server and retrieve call information. The database server manages the processor-intensive work such as data manipulation, compilation and optimization. It then, sends only the final results back to the SonicView application.



*Refer to the NEC SonicView Recorder User Guide and Installation Manual located on the AK System PC Apps CD (P/N 670830) for additional Information.*

## Recording Engine

The SonicView application uses the recording engine component to sniff and record all call information captured from the network. Typically, the recording engine should be installed on a server class machine with a network card that interfaces with a managed switch. After installing the SonicView application using the setup CD, the recording engine will not record any VoIP calls by default. To make this happen, you must ensure that the necessary network infrastructure and configurations are in place. For a detailed description of the network infrastructure required for call capture, refer to the Network Infrastructure section.

To make the necessary configurations on the recording engine to enable call capturing, refer to Configuring the Recorder subsection under the Administrative tasks section.



*Refer to the NEC IP SonicView Recorder User Guide and Installation Manual located on the AK System PC Apps CD (P/N 670830) for additional information.*

## SonicView On-Demand Recording (ODR) Client

The SonicView On-Demand Recording client is a convenient tool to record and view calls as they happen in real-time. This standalone desktop application can be downloaded and installed from the login page of the main application. For instructions to download and install this client, refer to the NEC IP Recorder SonicView installation and configuration guide.



*The use of monitoring, recording, or listening devices to eavesdrop, monitor, retrieve, or record telephone conversation or other sound activities, whether or not contemporaneous with transmission, may be illegal in certain circumstances under federal or state laws. Legal advice should be sought prior to implementing any practice that monitors or records any telephone conversation. Some federal and state laws require some form of notification to all parties to a telephone conversation, such as using a beep tone or other notification methods or requiring the consent of all parties to the telephone conversation, prior to monitoring or recording the telephone conversation. Some of these laws incorporate strict penalties.*

### Conditions

- If NEC Sonic View IP Recorder 1.0 has been installed previously, then the SonicView IP Recorder 1.0 must be uninstalled prior to installing NEC SonicView recorder 2.0.
- The PC hosting the recording engine component should be on the same subnet as the PBX for it to capture calls. Unless this configuration is made, no calls will be recorded.
- A Vista “Master Administrator” account (“Administrator”) is required to install the application. The user must enable the Vista Master Administrator account and log into this account to perform the installation. The Apache Tomcat web server, Apache Derby Database server and Recording Engine will not be installed correctly in non-master administrator accounts.
- A single-/multi-port managed switch with port mirroring setup is mandatory to enable call capturing over the network. The server hosting the recording engine should be connected to a managed switch (customer provided) such that the PBX’s traffic mirrored to the port on which the recording engine server is connected.

- Recording Digital terminals is now possible after adding the NEC-4 port digital call logging device via USB to the system that has the Digital recorder installed. See the SonicView Installation and Configuration guide for detailed information.
- Recording of internal Digital calls will result in no direction, name or number indication. Only the Receiving Terminal will show name and number. Recording of Digital terminals that have been assigned to trunk configuration will result in no number indication. Outgoing or incoming trunk calls with a Digital terminal will not show direction.
- Recording both IP and Digital terminals on the same server requires an additional NIC (network interface card).

## Default Settings

Not Installed

## System Availability

### Terminals

- NEC DT700 series (IP) Terminals – NEC SonicView Recorder
- NEC DT300 series (Digital) Terminals- NEC SonicView Recorder

### Required Component(s)

#### Only Application

- Hardware:
  - ❑ Pentium 1.8 GHz core 2 duo or above
  - ❑ A minimum of 4 GB RAM
  - ❑ 250 GB of free hard disk space (30000 hours of continuous recording)
  - ❑ SVGA monitor 1024 X 768 resolution
  - ❑ Network Interface Card (NIC)
- Supported Operating Systems:
  - ❑ Windows Server 2008, Windows 7, Windows Server 2003 with SP2, Windows Vista Business Edition with SP2, Windows XP Professional with SP3.

**Only Recording Server**

- Hardware:
  - Pentium 1.6 GHz core 2 duo or above
  - A minimum of 2 GB RAM
  - 250 GB of free hard disk space (30000 hours of continuous recording)
  - SVGA monitor 1024 X 768 resolution
  - Network Interface Card (NIC)
- Supported Operating Systems:
  - Windows Server 2008, Windows 7, Windows Server 2003 with SP2, Windows Vista Business Edition with SP2, Windows XP Professional with SP3.
- Application & Recording Server (both components on same server) Hardware:
  - Pentium 2.66 GHz core 2 duo or above
  - A minimum of 4 GB RAM
  - 250 GB of free hard disk space (30000 hours of continuous recording)
  - SVGA monitor 1024 X 768 resolution
  - Network Interface Card (NIC)
- Supported Operating Systems:
  - Windows Server 2008, Windows 7, Windows Server 2003 with SP2, Windows Vista Business Edition with SP2, Windows XP Professional with SP3.
- Client Side Requirements
  - Pentium 4 class machine
  - A minimum of 1 GB RAM
  - SVGA monitor 1024 X 768 resolution
  - Adobe Flash player plug-in version 10 or above
  - Adobe Acrobat Reader 7 or above (if client needs to view/edit reports)
  - Microsoft Excel 2000 (if client needs to view/edit reports)
  - Supported Internet browsers:
    - Microsoft Internet Explorer 7 and above
    - Mozilla Firefox version 3.2 or above
    - Google Chrome 3.0 or above

**Digital Terminal Recording Requirements**

NEC – 4-Port Digital Call Logging Hardware via USB.

## Related Features

None

Table 2-153 SV9100 CPU License (NEC SonicView Recorder)

670863 LKS-Recorder Basic Pkg-LIC		
Feature Code	Quantity Included	Comments
3200	4 Stations 1 Supervisor 4 ODRs (On-Demand Recording)	Provides the ability to have four stations, one Supervisor Login and up to four On-Demand Recording clients.
670864 LKS-Recorder Basic Port Add-on 4-LIC		
Feature Code	Quantity Included	Comments
3202	4 Additional Stations	Provides the ability to record four additional stations over the initial four received with 670863.
670865 LKS-Recorder Basic Port Add-on 1-LIC		
Feature Code	Quantity Included	Comments
3202	1 Additional Station	Provides the ability to record one additional station over the initial four received with 670863.
670862 LKS-Recorder Basic SUPV Add-on 1-LIC		
Feature Code	Quantity Included	Comments
3201	1 Additional Supervisor	Provides one additional Supervisor Login.

## Guide to Feature Programming

The **Level 1**, **Level 2** and **Level 3** columns indicate the programs that are assigned when programming this feature in the order they are most commonly used. These levels are used with PCPro and WebPro wizards for feature programming.

- Level 1 – these are the most commonly assigned programs for this feature.
- Level 2 – these are the next most commonly assigned programs for this feature.
- Level 3 – these programs are not often assigned and require an expert level working knowledge of the system to be properly assigned.

Program Number	Program Name/Description	Input Data	Default	Level		
				1	2	3
14-02-10	<b>Analog Trunk Data Setup – Caller ID</b> Enable/Disable a trunk ability to receive Caller ID information.	Trunks 1 ~ 400 0 = No 1 = Yes	0	✓		

Program Number	Program Name/Description	Input Data	Default	Level		
				1	2	3
15-03-10	<b>Single Line Telephone Basic Data Setup – Caller ID Name</b> Determine whether or not a single line telephone should display the Caller ID name.	0 = Disable 1 = Enable	1	✓		
15-05-50	<b>IP Telephone Terminal Basic Data Setup – Peer to Peer Mode</b> On a per station basis enable or disable Peer to Peer mode.	0 = Disable 1 = Enable	1	✓		
20-08-15	<b>Class of Service Options (Outgoing Call Service) – Block Outgoing Caller ID</b> Turn Off or On a user Class of Service from automatically blocking outgoing Caller ID information when a call is placed. If block is enabled, the system automatically inserts the Caller ID block code *67 (defined in Program 14-01-21) before the user dialed digits (this requires Program 14-02-10 to be enabled). If block is disabled, the system outdials the call just as it was dialed by the user.	0 = Off 1 = On	COS 1 ~ 15 = 0		✓	
20-09-02	<b>Class of Service Options (Incoming Call Service) – Caller ID Display</b> Turn Off or On the Caller ID display at an extension.	0 = Off 1 = On	COS 1 ~ 15 = 0	✓		
20-19-01	<b>System Options for Caller ID – Caller ID Displaying Format (If displaying digits are more than 12 digits)</b> Determine whether the first 10 digits or last 10 digits should be displayed when Caller ID exceeds 12 digits.	0 = First 10 digits (Upper) 1 = Last 10 digits (Lower)	0		✓	

## Operation



- Refer to the *SonicView User Guide* for operational details.
- Refer to the following manuals for detailed information regarding the *NEC SonicView Recorder*:
  - *NEC SonicView Recorder Installation and Setup Manual*
  - *NEC SonicView Recorder Application User Guide*

## NEC SonicView Recorder (2.7)

### Description

The NEC SonicView™ Recorder application is an easy-to-use yet powerful web-based call recording solution. The SonicView software offers robust features designed specifically for business users who want to make use of Enterprise call data for reporting, analysis and monitoring.

### Conditions

Table 2-154 Known Limitations

ID	Item Description	Comments															
1	<b>Installation - Windows Vista &amp; 7 Specific Restrictions</b>																
1.1	A Windows Vista, Windows 7 Professional/Ultimate "Master Administrator" account ("Administrator") is required to install the application.	The user must enable the Windows Vista, Windows 7 Professional/Ultimate Master Administrator account and log into this account to perform the installation. The Apache Tomcat web server, Apache Derby Database server and Recording Engine will not be installed correctly in non-master administrator accounts.															
1.2	A Windows 7 Professional/Ultimate, Program Compatibility Assistant.	During SonicView™ installation on Windows 7 Professional/Ultimate, you will see Program Compatibility Assistant window for 'StopRemoval LicenseServer.EXE', so user should select 'This Program is installed Correctly' option to proceed further.															
2	<b>Network Infrastructure dependencies</b>																
2.1	A single/multi port managed switch with port mirroring setup is mandatory to enable call capturing over the network.	The server hosting the recording engine should be connected to a managed switch such that the PBX's traffic mirrored to the port on which the recording engine server is connected.															
3	<b>Known Limitations of the Solution</b>																
3.1	Outbound and internal calls are recorded even if the called party does not answer the call. Such recordings include the DTMF tones as well as the phone ringing activities.	For example, if a call is established between STA131 and 503 429 8643 – even if the outbound party does not answer the call, the recording will begin and show in the application. If the user plays the recorded audio, he/she will be able to hear the DTMF and the phone ring tones.															
3.2	If an extension number is the same as a trunk line number, then calls to and from this extension show as an Outbound and Inbound call respectively.	For example, if a you have a trunk number 101 and an extension number 101 then the call details are shown as: <table border="1" data-bbox="880 1608 1406 1738"> <thead> <tr> <th>Direction</th> <th>Ext</th> <th>Agent Name</th> <th>Name</th> <th>Number</th> </tr> </thead> <tbody> <tr> <td>In</td> <td>101</td> <td>STA101</td> <td>STA131</td> <td>131</td> </tr> <tr> <td>Out</td> <td>131</td> <td>STA131</td> <td>STA101</td> <td>101</td> </tr> </tbody> </table>	Direction	Ext	Agent Name	Name	Number	In	101	STA101	STA131	131	Out	131	STA131	STA101	101
Direction	Ext	Agent Name	Name	Number													
In	101	STA101	STA131	131													
Out	131	STA131	STA101	101													
3.3	When a party drops and rejoins a conference, the new call will show as a separate call.	For example, if conference calls are established between three parties – STA 130, STA 131 and STA 132. If STA 130 drops from the conference, and reconnects back in to the same conference again, then technically this is identified as a new conference call.															



Table 2-154 Known Limitations (Continued)

ID	Item Description	Comments																																										
3.4	Answering multiple calls within intervals of 5 seconds causes the calls to display with incorrect caller ID.																																											
3.5	Participant's details are missing in the conference.	<p>For example, if a In call is landed on 101, later 101 consulted with 102 and initiated 3-party conference then the call details are shown as:</p> <table border="1" data-bbox="883 512 1498 779"> <thead> <tr> <th>Type</th> <th>Direction</th> <th>Ext</th> <th>Agent Name</th> <th>Name</th> <th>Number</th> </tr> </thead> <tbody> <tr> <td>Conf</td> <td>Int</td> <td>102</td> <td>STA102</td> <td>STA101</td> <td>101</td> </tr> <tr> <td>Conf</td> <td>Int</td> <td>101</td> <td>STA101</td> <td>STA102</td> <td>102</td> </tr> <tr> <td></td> <td>Int</td> <td>102</td> <td>STA102</td> <td>STA101</td> <td>101</td> </tr> <tr> <td></td> <td>Int</td> <td>101</td> <td>STA101</td> <td>STA102</td> <td>102</td> </tr> <tr> <td></td> <td>In</td> <td>101</td> <td>STA103</td> <td>Unavailable</td> <td>5034391111</td> </tr> </tbody> </table>	Type	Direction	Ext	Agent Name	Name	Number	Conf	Int	102	STA102	STA101	101	Conf	Int	101	STA101	STA102	102		Int	102	STA102	STA101	101		Int	101	STA101	STA102	102		In	101	STA103	Unavailable	5034391111						
Type	Direction	Ext	Agent Name	Name	Number																																							
Conf	Int	102	STA102	STA101	101																																							
Conf	Int	101	STA101	STA102	102																																							
	Int	102	STA102	STA101	101																																							
	Int	101	STA101	STA102	102																																							
	In	101	STA103	Unavailable	5034391111																																							
3.6	When a call is being transferred multiple times between VOIP and Digital extension, the recording will show Duplicate calls for the last-1 VoIP extension.	<p>For example, if a In call is landed on VoIP extension number 130, consulted and transferred through multiple extension (102, 106, 103 &amp; 131). Assume last-1 VoIP extension is 131, then the call details are shown as:</p> <table border="1" data-bbox="883 926 1498 1213"> <thead> <tr> <th>Type</th> <th>Direction</th> <th>Ext</th> <th>Duration</th> <th>Name</th> <th>Number</th> </tr> </thead> <tbody> <tr> <td>Trf</td> <td>In</td> <td>131</td> <td>01:12:00</td> <td>STA131</td> <td>5034391111</td> </tr> <tr> <td>Trf</td> <td>In</td> <td>131</td> <td>01:12:00</td> <td>STA131</td> <td>5034391111</td> </tr> <tr> <td></td> <td>Int</td> <td>103</td> <td>00:02:00</td> <td>STA103</td> <td>105</td> </tr> <tr> <td></td> <td>Int</td> <td>106</td> <td>00:06:10</td> <td>STA106</td> <td>107</td> </tr> <tr> <td></td> <td>Int</td> <td>102</td> <td>00:05:00</td> <td>STA102</td> <td>104</td> </tr> <tr> <td></td> <td>In</td> <td>130</td> <td>00:02:00</td> <td>STA130</td> <td>5034391111</td> </tr> </tbody> </table>	Type	Direction	Ext	Duration	Name	Number	Trf	In	131	01:12:00	STA131	5034391111	Trf	In	131	01:12:00	STA131	5034391111		Int	103	00:02:00	STA103	105		Int	106	00:06:10	STA106	107		Int	102	00:05:00	STA102	104		In	130	00:02:00	STA130	5034391111
Type	Direction	Ext	Duration	Name	Number																																							
Trf	In	131	01:12:00	STA131	5034391111																																							
Trf	In	131	01:12:00	STA131	5034391111																																							
	Int	103	00:02:00	STA103	105																																							
	Int	106	00:06:10	STA106	107																																							
	Int	102	00:05:00	STA102	104																																							
	In	130	00:02:00	STA130	5034391111																																							
3.7	Configure License Server tool to modify PBX IP address, Port, MAC address, Web Server IP address & Port will not support modifying the Web Server IP address & Port.	Known issues with modifying the Web Server IP address & Port from Configure License Server tool.																																										
3.8	License Server drops the license after making configuration changes on secondary NIC card.	Scenario where you have configured the primary NIC card in the application to capture the licenses from SV9100 phone system. Assume you have got the licenses and are registered with Primary NIC card. Sometimes later if you uninstall/install/modify secondary NIC card that was configured for another recorder will result in license loss from the primary NIC card. Recommended solution to get licenses back is to reconfigure correct primary NIC card in the application.																																										
3.9	EXTERNAL calls posted from Digital Recovery service shows direction as INTERNAL instead of INBOUND or OUTBOUND.	Known limitation with NEC 4-Port Digital Call Logging Hardware device. i.e., it is unable to capture right direction of the call.																																										
3.10	VoIP Recovery: Outbound/ Inbound call that has Hold and Un-hold scenarios will split single call in to two different calls when posted through Recovery service.	Outbound/ Inbound call that has Hold and Un-hold scenarios experience a SonicView recorder crash will recover this call, but when it is posted to an application you will observe two calls, one call will have recording till Hold and another call is from where you Un-hold the call.																																										

Table 2-154 Known Limitations (Continued)

ID	Item Description	Comments
3.11	Recording Rules: The rules perform exact match for dialed number in outgoing calls.	If a recording rule is made for 503 429 8643 and the user dials 503 429 86431111 instead, then the call will not be captured in the application even if it was established via the PBX.
3.12	Recording Rules: The application will not permit creation of more than one active <b>Recording Rule</b> per extension.	You may create a rule for STA 131, and enable the rule. However, if another rule is created for STA 131, then this rule will be disabled by default. The user will have to disable the first rule to be able to enable the newer rule.
3.13	The IP Recorder and/or Digital Recorder should be restarted to apply the configuration changes to new recordings.	The user will have to restart the 'SonicView VoIP Recorder' or the 'SonicView Digital Recorder' service to apply changes in the <b>Recorder Configuration</b> and <b>Recording Rules</b> sections to the new recordings.
3.14	Default recording rule for Call Duration: Default minimum threshold for recording calls is 20 seconds.	The default minimum call duration threshold value is 20 seconds; therefore you may not see calls shorter than this duration show up in the application. The value of this threshold can be changed using the Administration Console.
3.15	Recording Rules based on caller & dialed numbers will not work for UC Desktop Suite calls.	Recording rules for outbound calls from UC Desktop Suite should be created with the '*' wildcard or dialed numbers prefixed with the trunk access code to work correctly. Similarly, recording rules for inbound calls to UC Desktop Suite should be created with the '*' wildcard or caller ID to work correctly.
3.16	The Recording Engine will not record calls over a SIP trunk.	Not supported in this release.
3.17	Statistics – The Extension-Duration statistic will not display when only one call is being displayed in the call information grid.	An area chart cannot be displayed for the Extension-Duration statistic for one data point as an area chart requires at least 2 data points (or calls) to render.
3.18	Advanced 'Player Controls': The transport controls in media player in the application do not work as intended for short duration call recordings.	The rewind, forward, pause controls and dragging the slider may cause the stream to stop playing and not resume.
3.19	Live monitor: The automatic refresh interval for recordings using 'Live Monitor' should not be very short. This may degrade the application performance in a high call volume environment.	It is recommend that the user performs a manual 'Refresh' when more than 500 calls are displayed at a time in the call recording grid (WorkArea of the application).
3.20	The 'Do not record Calls lesser than...' option in the recorder configuration will not apply to calls recorded using the On-Demand recording client application.	If this value is set to 30 seconds, then a call recorded from the On-Demand client will be saved even if it is less than 30 seconds in duration.
3.21	When a call recording is initiated from the ODR client and the client is closed, the recording will continue till the call is terminated.	If a user initiates a call using the ODR client and closes the client without clicking on the stop icon, then a prompt warning the user about recordings being terminated comes up. However, irrespective of the user action, the complete call is recorded and saved.
3.22	Supervised transfers will show, as linked calls in the application but blind transfers will not be linked.	Blind transfer calls will show as independent calls in the SonicView™ application.

Table 2-154 Known Limitations (Continued)

ID	Item Description	Comments															
3.23	When the ODR toolbar experiences network problem, the active call during this process may end up in losing the call information.	For example, if a call is established between STA131 and 503 429 8643 an outbound party and user experiences network problem, the respective call will end up in showing incomplete information in the SonicView™ application and also user cannot play back this call.															
3.24	Initiating Outbound and internal calls from ODR toolbar able to record and playback calls even though they were not actually established.	For example, if a call is established between STA131 and 503 429 8643 – even if the outbound party does not answer the call, clicking on ODR’s recording button at STA131 will record the voice file of the ODR user.															
3.25	When the ODR toolbar experiences SonicView recorder crashing due to unexpected circumstances, you will observe TWO calls, one call with 00:00:00 duration and another call with actual duration (i.e, recovered call during engine crash).	For example, if a Out call is initiated by extension 101 then the SonicView Recorder crash in between and now call details are shown as: <table border="1" data-bbox="915 726 1468 856"> <thead> <tr> <th>Direction</th> <th>Ext</th> <th>Duration</th> <th>Name</th> <th>Number</th> </tr> </thead> <tbody> <tr> <td>Out</td> <td>101</td> <td>00:00:00</td> <td>STA101</td> <td>5034392222</td> </tr> <tr> <td>Out</td> <td>101</td> <td>02:17:40</td> <td>STA101</td> <td>5034392222</td> </tr> </tbody> </table>	Direction	Ext	Duration	Name	Number	Out	101	00:00:00	STA101	5034392222	Out	101	02:17:40	STA101	5034392222
Direction	Ext	Duration	Name	Number													
Out	101	00:00:00	STA101	5034392222													
Out	101	02:17:40	STA101	5034392222													
3.26	The SonicView™ application will fail to display licensing information correctly if the Recorder MAC Address entered during the installation and in the Recorder Configuration screen in the application are entered differently.	For instance if the Recorder MAC address entered during the installation is 00-0F-04-05-6D and the MAC address entered in the Recorder Configuration screen is 000f04056d (note that the alphabets are in lower casing) – in this case, the licensing information will not be fetched from the PBX and the application will remain unlicensed.															
3.27	The SonicView™ application will register license details either against the VoIP or the Digital recorder depending on which MAC address is being used for licensing.	If license is registered to either VoIP or Digital recorder, then only port details belonging to registered recorder will be displayed in the License screen. But the calls between VoIP and Digital extensions will record as intended to record.															
3.28	Re-installation over an existing installation is not supported.	Installing the Hybrid Installer over an existing Hybrid recorder installation will result in a corrupt installation and unusable system.															
3.29	Digital recorder: Recordings details for TDM/Digital extensions will not show the call direction.	For example, if a you have a TDM/Digital extension 101 that was part of an Outbound/Inbound/Internal call then the call details are shown as: <table border="1" data-bbox="920 1394 1459 1499"> <thead> <tr> <th>Direction</th> <th>Ext</th> <th>Agent Name</th> <th>Name</th> <th>Number</th> </tr> </thead> <tbody> <tr> <td></td> <td>101</td> <td>STA101</td> <td>Unavailable</td> <td>Unavailable</td> </tr> </tbody> </table>	Direction	Ext	Agent Name	Name	Number		101	STA101	Unavailable	Unavailable					
Direction	Ext	Agent Name	Name	Number													
	101	STA101	Unavailable	Unavailable													
3.30	Digital recorder: Recordings details for TDM/Digital extensions will not show the Caller ID for Inbound calls.	For example, if a you have a TDM/Digital extension 101 that was part of an Inbound call then the call details are shown as: <table border="1" data-bbox="920 1619 1459 1724"> <thead> <tr> <th>Direction</th> <th>Ext</th> <th>Agent Name</th> <th>Name</th> <th>Number</th> </tr> </thead> <tbody> <tr> <td></td> <td>101</td> <td>STA101</td> <td>Unavailable</td> <td>Unavailable</td> </tr> </tbody> </table>	Direction	Ext	Agent Name	Name	Number		101	STA101	Unavailable	Unavailable					
Direction	Ext	Agent Name	Name	Number													
	101	STA101	Unavailable	Unavailable													

Table 2-154 Known Limitations (Continued)

ID	Item Description	Comments										
3.31	Digital recorder: Recordings details for TDM/Digital extensions will not show the Calling Party number for Outbound calls.	For example, if a you have a TDM/Digital extension 101 that was part of an Outbound call then the call details are shown as: <table border="1" data-bbox="873 438 1414 543"> <thead> <tr> <th>Direction</th> <th>Ext</th> <th>Agent Name</th> <th>Name</th> <th>Number</th> </tr> </thead> <tbody> <tr> <td></td> <td>101</td> <td>STA101</td> <td>Unavailable</td> <td>Unavailable</td> </tr> </tbody> </table>	Direction	Ext	Agent Name	Name	Number		101	STA101	Unavailable	Unavailable
Direction	Ext	Agent Name	Name	Number								
	101	STA101	Unavailable	Unavailable								
3.32	Digital recorder: Linking of Trf/Conf calls and call types for TDM/Digital extensions in SV9100 phone system.	Linking of Trf/Conf calls and call types will not support for TDM/Digital extensions. The entire Trf/Conf call details will show in a single call.										
3.33	Schedule Reports will not 'Play' the records from EXCEL sheet.	Schedule Reports will show 'Play' link, if you have configured SonicView reports to be delivered as EXCEL sheet. But user cannot able to play the recording using this option.										
3.34	The Recording Engine will not record calls over a NAT environment in case of SV8300 Phone system.	Not supported in this release.										
4	<b>Required Configuration\Settings</b>											
4.1	The server hosting the recording engine software should be configured to have the same subnet as that of the PBX.											
4.2	Silence activity detection should be disabled in the PBX.	If Silence activity detection is enabled, then the recorded calls will have overlapping voice channels and will sound as though both the parties involved in the call are speaking simultaneously.										
4.3	Recording internal calls between IP Telephones: Peer to Peer Media (RTP Traffic) must be disabled if a single port-mirroring switch is used.	Peer to Peer Media (RTP Traffic) must be disabled on all the registered telephones to force their RTP traffic to traverse via the PBX. Alternatively, a managed Ethernet switch that supports the ability to mirror many ports to a single port as well as writing from the mirrored port is required.										
4.4	Archiving data to a remote destination will not work unless the database server service (PostgreSQL or Microsoft SQL server – as the case may be) has domain credentials to write to the particular location in question.	If a user is trying to archive calls to a system other than the system on which PostgreSQL or Microsoft SQL server is installed, then the archive file will not be created unless the database service has domain credentials to write to the remote location.										
4.5	Application supports recording only for calls that involve at least one VoIP/Digital extension.	Only calls where at least one of the participating members is a VoIP/Digital extension will be recorded in the present release.										

## Default Settings

Not Installed

## System Availability

### Terminals

- NEC DT700 series (IP) Terminals – NEC SonicView Hybrid Recorder
- NEC DT300 series (Digital) Terminals- NEC SonicView Hybrid Recorder

### Required Component(s)

Ensure the following hardware and software requirements are met before starting the SonicView installation:

- ◇ *These recommendations are to be used as a minimum requirements guideline only. Actual requirements may vary based on specific needs such as recording call volume, number of ports to be recorded and number of remote locations etc.*

### Minimum System Requirements

Table 2-155 System Minimum Requirements

Recording Capacity	Server Hardware Specifications (See Note 1)	Recommended Operating Systems (See Note 2)
Up to 40 Stations	1	1, 2, 3, 4, 5
Up to 100 Stations	2	1 & 4 (Windows Server OS)
Up to 256 Stations	3	1 & 4 (Windows Server OS)
Greater than 256 Stations	Consult with NEC	1 & 4 (Windows Server OS)
Digital 04s (up to 3 devices per PC)	1	1, 2, 4, 5
Digital 16s (up to 2 devices per PC)	1	1, 2, 4, 5

Note 1: Refer to [Table 2-156 Server Hardware Matrix](#) for Hardware Specifications ID.

Note 2: Refer to [Table 2-159 Supported Operating Systems on page 2-1796](#) for Operating Systems ID.

**Hardware**

○ Server:

*Table 2-156 Server Hardware Matrix*

ID	Hardware	Specifications
1	Processor	Intel Core 2 Duo (2.8 GHz or higher)
	Harddrive	200 GB hard disk space (138 hours of recording per GB)
	Other	Refer to <a href="#">Table 2-157 Common Hardware Requirements on page 2-1794</a>
2	Processor	Quad Core XEON 2.0 GHz (dual processors preferred)
	Harddrive	500 GB hard disk space (138 hours of recording per GB)
	Other	Refer to <a href="#">Table 2-157 Common Hardware Requirements on page 2-1794</a>
3	Processor	Dual Processor Quad Core XEON 2.4 GHz
	Harddrive	1TB hard disk space (138 hours of recording per GB)
	Other	Refer to <a href="#">Table 2-157 Common Hardware Requirements on page 2-1794</a>

○ Common:

*Table 2-157 Common Hardware Requirements*

Hardware	Specification
RAM	Minimum 4 GB RAM or higher, 16 GB where WIndows Server OS is used
Ethernet Card	2 NICs (Gigabit Ethernet Cards)
Sound Card	General MIDI capable sound card
Monitor/Display	SVGA monitor 1024 X 768 resolution
USB (only with Digital Devices)	1.1 or 2.0 – One dedicated USB port per device
USB Controller (only with Digital 16 Devices)	1 Dedicated USB Controller per device

○ NICs (2 Required):

One (1) Network Interface card (NIC) is sufficient provided the Managed Switch performing port mirroring supports both Ingress and Egress traffic on the mirrored port. Two (2) Network Interface cards (NIC) are required in case of Hybrid installation (one for associating with IP Recorder and other NIC for Digital Recorder) OR if the Managed Switch does not support bi-directional (Ingress and Egress) traffic on the mirrored port.

◇ *When using two NIC cards, only one of the NIC cards should be configured to connect to the LAN (with Gateway and DNS). The other NIC should only be configured to connect to the mirrored port on the Managed Switch and can be associated with the IP Recorder. When used in Hybrid mode to record both Digital and IP stations, the NIC connected to the LAN can be associated with the Digital Recorder.*

○ When using SonicView with Digital Recorder units (VSR Hardware) for Digital Station recording, mixing different phone models within a single installation of SonicView is not recommended.

□ The PC and Digital Recorder units need to be installed within at least six feet of the pbx/mdf/ tap points. This is to avoid distortion in the recordings when not installed to specification.

○ SonicView Supervisor/Agent Recommendations:

*Table 2-158 Supervisor/Agent Studio PC Recommendations*

System Minimums	Specification (See Note 1)
Processor	Intel Pentium 4 class machine
RAM	Minimum 2 GB RAM or higher
Harddrive	20 GB hard disk space
Ethernet Card	1 NIC (10/100 or GB)
Sound Card	General MIDI capable sound card
Monitor Display	SVGA monitor 1024 X 768 resolution
Software Requirements	Adobe Flash player plug-in version 10 or above
	Adobe Acrobat Reader 7 or above (to view PDF reports)
	Microsoft® Excel 2000 (to view/edit reports)
	Microsoft® Internet Explorer 7 or above, Mozilla Firefox version 3.0 or above; Google Chrome 3.0 or above, Opera 4 or above, Safari 10.01 or above
	. NET 3.0 and above
Operating Systems	1, 2, 3, 4, 5

Note 1: Refer to [Table 2-159 Supported Operating Systems](#) for Operating Systems ID.

○ Operating System:

*Table 2-159 Supported Operating Systems*

Operating System	ID
Windows Server 2008 with SP1	1
Windows 7 Professional	2
Windows Vista Business Edition with SP2	3
Windows Server 2003 with SP2	4
Windows XP Professional with SP3	5

○ Database:

*Table 2-160 Supported Databases*

Database Type
32-bit/64-bit Microsoft SQL Server 2008
32-bit/64-bit Microsoft SQL Server 2005
32-bit PostgreSQL Server 8.3 only

○ CPU Licenses:

*Table 2-161 SV9100 CPU License (NEC SonicView Recorder)*

670863 LKS-Recorder Basic Pkg-LIC		
Feature Code	Quantity Included	Comments
3200	4 Stations 1 Supervisor 4 ODRs (On-Demand Recording)	Provides the ability to have four stations, one Supervisor Login and up to four On-Demand Recording clients.
670864 LKS-Recorder Basic Port Add-on 4-LIC		
Feature Code	Quantity Included	Comments
3202	4 Additional Stations	Provides the ability to record four additional stations over the initial four received with 670863.
670865 LKS-Recorder Basic Port Add-on 1-LIC		
Feature Code	Quantity Included	Comments
3202	1 Additional Station	Provides the ability to record one additional station over the initial four received with 670863.
670862 LKS-Recorder Basic SUPV Add-on 1-LIC		
Feature Code	Quantity Included	Comments
3201	1 Additional Supervisor	Provides one additional Supervisor Login.



Table 2-161 SV9100 CPU License (NEC SonicView Recorder) (Continued)

670889 LKS-Recorder Call Scoring 1-LIC		
Feature Code	Quantity Included	Comments
3204	1 IP Recorder Call Scoring	Provides one IP recorder call scoring.
670990 LKS-Recorder Automated Reports 1-LIC		
Feature Code	Quantity Included	Comments
3205	1 IP Recorder Automated Reporting	Provides one IP recorder automated reporting.
670991 LKS-Recorder Add On 256 Port-LIC		
Feature Code	Quantity Included	Comments
3204	1 256 Port Add-on to Record 256 Stations	Provides one additional 256 port to record 256 stations.

## Related Features

None

## Guide to Feature Programming

The **Level 1**, **Level 2** and **Level 3** columns indicate the programs that are assigned when programming this feature in the order they are most commonly used. These levels are used with PCPro and WebPro wizards for feature programming.

- Level 1 – these are the most commonly assigned programs for this feature.
- Level 2 – these are the next most commonly assigned programs for this feature.
- Level 3 – these programs are not often assigned and require an expert level working knowledge of the system to be properly assigned.

Program Number	Program Name/Description	Input Data	Default	Level		
				1	2	3
14-02-10	<b>Analog Trunk Data Setup – Caller ID</b> Enable/Disable a trunk ability to receive Caller ID information.	Trunks 1 ~400 0 = No 1 = Yes	0	✓		
15-03-10	<b>Single Line Telephone Basic Data Setup – Caller ID Name</b> Determine whether or not a single line telephone should display the Caller ID name.	0 = Disable 1 = Enable	1	✓		
15-05-50	<b>IP Telephone Terminal Basic Data Setup – Peer to Peer Mode</b> On a per station basis enable or disable Peer to Peer mode.	0 = Disable 1 = Enable	1	✓		

Program Number	Program Name/Description	Input Data	Default	Level		
				1	2	3
20-08-15	<b>Class of Service Options (Outgoing Call Service) – Block Outgoing Caller ID</b> Turn Off or On a user Class of Service from automatically blocking outgoing Caller ID information when a call is placed. If block is enabled, the system automatically inserts the Caller ID block code *67 (defined in Program 14-01-21) before the user dialed digits (this requires Program 14-02-10 to be enabled). If block is disabled, the system outdials the call just as it was dialed by the user.	0 = Off 1 = On	COS 1 ~ 15 = 0		✓	
20-09-02	<b>Class of Service Options (Incoming Call Service) – Caller ID Display</b> Turn Off or On the Caller ID display at an extension.	0 = Off 1 = On	COS 1 ~ 15 = 0	✓		
20-19-01	<b>System Options for Caller ID – Caller ID Displaying Format (If displaying digits are more than 12 digits)</b> Determine whether the first 10 digits or last 10 digits should be displayed when Caller ID exceeds 12 digits.	0 = First 10 digits (Upper) 1 = Last 10 digits (Lower)	0		✓	

## Operation



REFERENCE

- Refer to the *SonicView User Guide* for operational details.
- Refer to the following manuals for detailed information regarding the *NEC SonicView Recorder*:
  - *NEC SonicView Recorder Installation and Setup Manual*
  - *NEC SonicView Recorder Application User Guide*

## Voice Mail Integration (Analog)

### Description

The system provides telephone users with comprehensive Voice Mail features. Voice Mail ends the frustration and cost of missed calls, inaccurate written messages and telephone tag. This frees busy receptionists and secretaries for more productive work.

External voice mail requires available analog station ports based on the number of voice mail ports connected.

Integrated voice mail enhances the telephone system with the following features:

**Call Forwarding to Voice Mail**

An extension user can forward their calls to Voice Mail. Once forwarded, calls to the extension connect to that extension mailbox. The caller can leave a message in the mailbox instead of calling back later. Forwarding can occur for all calls immediately, for unanswered calls or only when the extension is busy. When a user transfers a call to an extension forwarded to Voice Mail, the call waits for the Delayed Call Forwarding time before routing to the called extension mailbox. This gives the transferring party the option of retrieving the call instead of having it go directly to the mailbox.

**Leaving a Message**

Voice Mail lets a multiline terminal extension user easily leave a message at an extension that is unanswered, busy or in Do Not Disturb. The caller can press their Voice Mail key to leave a message in the called extension mailbox. There is no need to call back later.

**Transferring to Voice Mail**

By using Transfer to Voice Mail, a multiline terminal extension user can Transfer a call to the user's or a co-worker's mailbox. After the Transfer goes through, the caller can leave a message in the mailbox.

### Voice Mail Queuing

When accessing the voice mail, the system provides a voice mail queue. If all the voice mail ports are busy, calls trying to get to the voice mail are placed in queue. As the voice mail ports become available, the calls are connected to the voice mail in the order in which they were received.

As the Voice Mail Queue follows Department Hunting programming, the queue can hold a maximum of 10 calls. If the queue is full or if the voice mail ports are not assigned to a Department Group, the calls are handled as though no voice mail queuing feature is enabled. The calls either access voice mail if a port is available or they receive a busy signal.



NOTE

*The Voice Mail Queuing feature does not work with the Conversation Record feature.*

### MSG Key will Operate as Voice Mail Key

The system enhances a telephone MSG key function when connected to a system which has voice mail installed. When an extension receives a voice mail, the MSG key can be used to check the number of messages in voice mail, or call the voice mail to listen to the messages.

### Analog Voice Mail Protocol Leading and Trailing Digits Assignment

The Analog Voice Mail Protocol Leading Digits (chassis to VM) and the Trailing Digits format can be changed.

The following chart illustrates the input data for Program 45-04-01~Program 45-04-09 (Voice Mail Digit Add Assignment) based on the setting in Program 45-01-15 (Analog Voice Mail Protocol Selection) and Program 45-01-17 (Reply Mailbox Number). If Program 45-01-15 is set to 0 it uses the Fixed Memory Location for the Leading Digits or, if set to 1 it uses Program 45-04-01~Program 45-04-09 for the Leading Digits. If Program 45-01-17 is set to 0, it does not have the calling party in the Trailing Digits.



*The default values for Program 45-04-01~Program 45-04-09 are not assigned.*

Use the chart below to determine what leading and trailing digits are sent to the Analog Voice Mail System.

Program	Program 45-01-15 (0 = Fixed) Program 45-01-17 (1=Yes or 0=No)	Program 45-01-15 (1 = Program) Program 45-01-17 (1=Yes)	Program 45-01-15 (1=Program) Program 45-01-17 (0=No)	Description
45-04-01 - <b>Remote Logon (Internal)</b> Up to four digits * Default not assigned	***1XXX	Up to four digits + XXX	Up to four digits + XXX	<b>Remote Log-On (Internal)</b>  <input type="radio"/> Internal call to VM from extension XXX. <input type="radio"/> User has not indicated intent to enter mail box.
45-04-02 - <b>Direct Logon</b> Up to four digits * Default not assigned	#XXX	Up to four digits + XXX	Up to four digits + XXX	<b>Direct Log-On</b>  <input type="radio"/> Connect user to mail box for extension XXX.
45-04-03 - <b>Transfer Message</b>   Up to four digits * Default not assigned	***2YYY ***2XXXXYY	Up to four digits + YYY Or Up to four digits + XXXXYY	Up to four digits + YYY	<b>Transfer Message</b>  <input type="radio"/> User is transferring a call to VM <input type="radio"/> Record a message to be placed in mail box of extension YYY. <b>Record Message for Called Extension (QVM)</b> <input type="radio"/> Record a message to be placed in mail box of extension YYY. <input type="radio"/> Store source extension number XXX for automatic reply feature.

Program	Program 45-01-15 (0 = Fixed) Program 45-01-17 (1=Yes or 0=No)	Program 45-01-15 (1 = Program) Program 45-01-17 (1=Yes)	Program 45-01-15 (1=Program) Program 45-01-17 (0=No)	Description
45-04-04 - <b>Forward-All</b>  Up to four digits * Default not assigned	***3UUUZZZ	Up to four digits + UUUZZZ	Up to four digits + ZZZ	<b>Forward-All</b>  ○ Extension or Trunk UUU that called extension ZZZ and was forwarded to the Voice Mail Box of extension ZZZ.
45-04-05 - <b>Forward-Busy</b>  Up to four digits * Default not assigned	***4UUUZZZ	Up to four digits + UUUZZZ	Up to four digits + ZZZ	<b>Forward-Busy</b>  ○ Extension or Trunk UUU that called extension ZZZ and was forwarded to the Voice Mail Box of extension ZZZ.
45-04-06 - <b>Forward RNA</b>  Up to four digits * Default not assigned	***5UUUZZZ	Up to four digits + UUUZZZ	Up to four digits + ZZZ	<b>Forward RNA</b>  ○ Extension or Trunk UUU that called extension ZZZ and was forwarded to the Voice Mail Box of extension ZZZ.
45-04-07 - <b>Remote Logon</b>  Up to four digits * Default not assigned	***6TTT	Up to four digits + TTT	Up to four digits + TTT	<b>Remote Log-on</b>  ○ External call to Voice Mail from Trunk TTT. ○ Play welcome greeting and connect user to prompt.
45-04-08 - <b>Conversation Recording</b> Up to four digits * Default not assigned	***8NNN	Up to four digits + NNN	Up to four digits + NNN	<b>Conversation Recording</b>  ○ Record a message to be placed in voice mail box of extension NNN.
45-04-09 - <b>Clear Down String</b> Up to four digits * Default not assigned	9999	Up to four digits	Up to four digits	<b>Clear down string.</b>  ○ Terminate

\* = If leading digits are blanks, nothing will be sent to the Analog VM as integration.

### Conditions

- If using a GCD-LTA with analog voice mail the system must be reset after changing Program 15-03-03 for the changes to take affect.
- Ring Group calls do not follow extension call forwarding to voice mail.
- Only one Voice Mail system can be installed in an SV9100 system (Analog or Digital, but not both in same system). This restriction is because only one Department Group can be assigned for Voice Mail.
- If installing an Analog Voice Mail System, any Analog station port (Single line telephone port) can be assigned to support the Analog Voice Mail system. With an Expanded Port Package, the SV9100 supports up to 176 Analog station ports (22 x 8 ports = 176).

- If installing a InMail system (In-Skin product), an Analog station port (Single line telephone port) can be assigned to support the sending of DTMF tones and Disconnect Signal to support a Fax server or other like products.
- When using Programmed (45-01-15 = 1) integration and 45-04-XX is blank, no trailing digits are sent. You can allow only the trailing digits to be sent by setting 45-05-XX to 1.
- Stutter Dial Tone is supported to Single Line Telephones for Voice Mail Message Waiting.

### Default Settings

Disabled

## System Availability

### Terminals

All Terminals

### Required Component(s)

- GCD-4LCA (4-Port main blade)
- GPZ-4LCA (4-Port daughter board)
- GCD-8LCA (8-Port main blade)
- GPZ-8LCE (8-Port daughter board)

## Related Features

- ↳ **Barge-In**
- ↳ **Caller ID**
- ↳ **Direct Inward Line (DIL)**
- ↳ **Hold**
- ↳ **Message Waiting**
- ↳ **One-Touch Calling**
- ↳ **Programmable Function Keys**
- ↳ **Transfer**

## Guide to Feature Programming

The **Level 1**, **Level 2** and **Level 3** columns indicate the programs that are assigned when programming this feature in the order they are most commonly used. These levels are used with PCPro and WebPro wizards for feature programming.

- Level 1 – these are the most commonly assigned programs for this feature.
- Level 2 – these are the next most commonly assigned programs for this feature.
- Level 3 – these programs are not often assigned and require an expert level working knowledge of the system to be properly assigned.

Program Number	Program Name/Description	Input Data	Default	Level		
				1	2	3
10-09-01	<b>DTMF and Dial Tone Circuit Setup</b> Assign at least one circuit for DTMF reception (0 or 1). Use the following as a guide when allocating DTMF receivers: In light traffic sites, allocate one DTMF receiver for every 10 devices that use them. In heavy traffic sites, allocate one DTMF receiver for every five devices that use them.	0 = Common Use 1 = Extension Only 2 = Trunk Only	Circuit/Resource 01 ~ 08 = 1 (Extensions) Circuit/Resource 09 ~ 32 = 2 (Trunks) Circuit/Resource 33 ~ 144 = 0 (Common) When PZ-BS10 is installed, 81 ~ 144 are available		✓	
11-07-01	<b>Department Group Pilot Numbers – Dial</b> Assign a Department Group pilot number for the Voice Mail. The extensions are assigned to the group in Program 16-02-01.	Maximum of eight digits.	No Setting	✓		
11-11-50	<b>Service Code Setup (for Setup/Entry Operation) – Set Message Waiting Indication</b> Assign a Service Code to set a Message Waiting light from an Analog Voice Mail port.	SLT 0 ~ 9, *, # Maximum of eight digits	No Setting		✓	
11-11-51	<b>Service Code Setup (for Setup/Entry Operation) – Cancel Message Waiting Indication</b> Assign a Service Code to cancel a Message Waiting light from an Analog Voice Mail port.	SLT 0 ~ 9, *, # Maximum of eight digits	No Setting		✓	
15-02-26	<b>Multiline Telephone Basic Data Setup – MSG Key Operation Mode</b> Determine whether an extension MSG key should function as a Message key or Voice Mail key . If set as a Message key, the user can press the key to call the voice mail only when they have new messages. If set as a Voice Mail key, it functions as a normal Voice Mail key.	0 = Message Key 1 = Voice Mail Key	0	✓		

Program Number	Program Name/Description	Input Data	Default	Level		
				1	2	3
15-02-35	<b>Multiline Telephone Basic Data Setup – Message Waiting Lamp Cycle for Calling Extension</b> Select the Message Waiting flash pattern for the station that set the Message Waiting reminder.	1 = Cycle 1 2 = Cycle 2 3 = Cycle 3 4 = Cycle 4 5 = Cycle 5 6 = Cycle 6 7 = Cycle 7	7		✓	
15-02-36	<b>Multiline Telephone Basic Data Setup – Message Waiting Lamp Cycle for Called Extension</b> Select the Message Waiting flash pattern for the station that receives the Message Waiting reminder.	1 = Cycle 1 2 = Cycle 2 3 = Cycle 3 4 = Cycle 4 5 = Cycle 5 6 = Cycle 6 7 = Cycle 7	3		✓	
15-02-37	<b>Multiline Telephone Basic Data Setup – Voice Mail Message Wait Lamp Color</b> Select the color of the large LED when a voice mail message is waiting at the extension.	0 = Green 1 = Red	1		✓	
15-02-38	<b>Multiline Telephone Basic Data Setup – Voice Mail Message Wait Lamp Cycle</b> Select the cycle method that the large LED flashes when the extension has a VM Message Waiting set to an extension.	1 = Cycle 1 2 = Cycle 2 3 = Cycle 3 4 = Cycle 4 5 = Cycle 5 6 = Cycle 6 7 = Cycle 7	3		✓	
15-03-01	<b>Single Line Telephone Basic Data Setup – SLT Signaling Type</b> For each UNIVERGE SV9100 voice mail extension, set this option to 0.	0 = DP 1 = DTMF	1	✓		
15-03-03	<b>Single Line Telephone Basic Data Setup – Terminal Type</b> Enter 1 for this option to allow a single line port to receive DTMF tones after the initial call setup. Enter 0 to have the port ignore DTMF tones after the initial call setup. For Voice Mail, always enter 1 (e.g., receive DTMF tones). ➤ <i>If using a GCD-LTA with analog voice mail the system must be reset after changing Program 15-03-03 for the changes to take affect.</i>	0 = Normal 1 = Special	0	✓		
15-03-09	<b>Single Line Telephone Basic Data Setup – Caller ID Function – For External Module</b> Set to 0 when voice mail is used or the integration code for the disconnect function is incorrect.	0 = Disable 1 = Enable	0	✓		
15-03-16	<b>Single Line Telephone Basic Data Setup – Special DTMF Protocol Send</b> Determine whether or not to send the extension number of the phone forwarded to the extension when Program 15-03-03 is set to 1 and not in the VM group.	0 = No 1 = Yes	0		✓	



Program Number	Program Name/Description	Input Data	Default	Level		
				1	2	3
15-07-01	<p><b>Programmable Function Keys</b></p> <p>Assign a Voice Mail key to an extension. You must enter the Voice Mail key code (code 77) followed by:</p> <ul style="list-style-type: none"> <li>○ Your own extension number if you are setting up your own Voice Mail key.</li> <li>○ A virtual extension number if you are setting up a Message Center key for a virtual extension.</li> <li>○ A co-worker's extension number if you are setting up a Message Center key for an installed extension.</li> <li>○ An uninstalled extension number if you are setting up a Message Center key for an uninstalled extension.</li> </ul> <p>(Optional) Assign a Voice Mail Record key to an extension (code 78).</p> <p>(Optional) Assign a Personal Answering Machine Emulation key (code 16).</p> <p>(Optional) Use a Call Redirect key (49) to allow a user to transfer a call to another extension or voice mail without answering the call.</p>	<p>Line Key 1 ~ 48</p> <p>0 ~ 99 (Normal Function Code 751 by default)</p> <p>*00 ~ *99 (Appearance Function Code) (Service Code 752 by default)</p>	Refer to the Programming Manual for default values.		✓	
16-01-01	<p><b>Department Group Basic Data Setup – Department Name</b></p> <p>Assign a name to the Extension (Department) Groups.</p>	Maximum of 12 characters.	No Setting	✓		
16-01-02	<p><b>Department Group Basic Data Setup – Department Calling Cycle</b></p> <p>Set the call routing for Department Calling. Routing can be either circular (cycles to all phones in a group) or priority (cycles to the highest priority first).</p>	<p>0 = Normal Routing (Priority)</p> <p>1 = Easy – UCD Routing (Circular)</p>	0	✓		
16-01-03	<p><b>Department Group Basic Data Setup – Department Routing When Busy (Auto Step Call)</b></p> <p>Set how the system routes an Intercom call to a busy Department Group member. Intercom callers to the extension can either hear busy or route to the first available department number. This occurs only for direct calls to the extension, not the Department number assigned in Program 11-07.</p>	<p>0 = Normal (Intercom caller to busy department member hears busy)</p> <p>1 = Circular (Intercom callers to busy department member routes to idle member)</p>	0	✓		
16-01-04	<p><b>Department Group Basic Data Setup – Hunting Mode</b></p> <p>Set the action taken when a call reaches the last extension in the department group. Hunting is stopped or circular search continues.</p>	<p>0 = Last extension is called and hunting is stopped</p> <p>1 = Circular</p>	0	✓		

Program Number	Program Name/Description	Input Data	Default	Level		
				1	2	3
16-01-05	<b>Department Group Basic Data Setup – Extension Group All Ring Mode Operation</b> Determine whether calls ringing a Department Group should ring all extensions in the group simultaneously automatically or manually when using the service code defined in Program 11-12-09. When set to 1, only ICM and DID calls ring all stations in the Department Group.	0 = Manual 1 = Automatic	0	✓		
16-01-06	<b>Department Group Basic Data Setup – STG Withdraw Mode</b> Set the STG Withdraw Mode for each department group.	0 = Disable (Camp On) 1 = Enable (Overflow Mode)	0	✓		
16-01-07	<b>Department Group Basic Data Setup – Call Recall Restriction for STG</b> Determine whether or not an unanswered call transferred to a Department Group should recall the extension from which it was transferred.	0 = Disable (Recall) 1 = Enable (No Recall)	0	✓		
16-01-09	<b>Department Group Basic Data Setup – Department Hunting No Answer Time</b> Set the time a call rings a Department Group extension before hunting occurs.	0 ~ 64800 seconds	15	✓		
16-01-10	<b>Department Group Basic Data Setup – Enhanced Hunt Type</b> Set the type of hunting for each Extension (Department) Group.	0 = No queuing 1 = Hunting When Busy 2 = Hunting When Not Answered 3 = Hunting When Busy or No Answer	0	✓		
16-02-01	<b>Department Group Assignment for Extensions</b> Set up the Department Group called by the pilot number and the extension priority when the group is called. Call Pickup Groups are set up in Program 23-02.	Department Groups 1 ~ 64 Priority 1 ~ 9999	Default = All extensions in Department Group 1 with priority in port order: Port 1 priority = 1 Port 256 priority = 256		✓	
20-02-09	<b>System Options for Multiline Telephones – Disconnect Supervision</b> Enable/Disable disconnect supervision for the system trunks.	0 = Disable 1 = Enable	1		✓	
20-03-01	<b>System Options for Single Line Telephones – SLT Call Waiting Answer Mode</b> For a busy single line (500/2500) telephone, set the mode used to answer a camped-on trunk call. The default setting should be used.	0 = Hookflash (Hooking) 1 = Hookflash + Service Code 794 ▶ Service Code 654 is for Live Recording at SLT (Program 11-12-53).	0		✓	

Program Number	Program Name/Description	Input Data	Default	Level		
				1	2	3
20-06-01	<b>Class of Service for Extensions</b> Assign a Class of Service (1 ~ 15) to the voice mail extensions. You should use COS 14 for all time modes.	Day Night/Mode: 1 ~ 8 Class of Service of Extensions (1 ~ 15)	Extension port 101 = Class 15 All other extension port = Class 1		✓	
20-11-01	<b>Class of Service Options (Hold/Transfer Service) – Call Forward All</b> Turn Off or On an extension user ability to set Call Forward All.	0 = Off 1 = On	COS 1 ~ 15 = 1		✓	
20-11-02	<b>Class of Service Options (Hold/Transfer Service) – Call Forward When Busy</b> Turn Off or On an extension user ability to set Call Forward when Busy.	0 = Off 1 = On	COS 1 ~ 15 = 1		✓	
20-11-03	<b>Class of Service Options (Hold/Transfer Service) – Call Forwarding When Unanswered</b> Turn Off or On an extension user ability to set Call Forward when Unanswered.	0 = Off 1 = On	COS 1 ~ 15 = 1		✓	
20-11-04	<b>Class of Service Options (Hold/Transfer Service) – Call Forwarding (Both Ringing)</b> Turn Off or On an extension user ability to set Call Forward with Both Ringing.	0 = Off 1 = On	COS 1 ~ 15 = 1		✓	
20-11-05	<b>Class of Service Options (Hold/Transfer Service) – Call Forwarding with Follow Me</b> Turn Off or On an extension user ability to set Call Forward with Follow Me.	0 = Off 1 = On	COS 1 ~ 15 = 1		✓	
20-11-12	<b>Class of Service Options (Hold/Transfer Service) – Call Forwarding Off Premise (External Call Forwarding)</b> Turn Off or On an extension user ability to set up Call Forwarding Off-Premise at the extension.	0 = Off 1 = On	COS 1 ~ 15 = 0		✓	
20-13-01	<b>Class of Service Options (Supplementary Service) – Long Conversation Alarm</b> Turn Off or On the Warning Tone for Long Conversation (not for single line telephones).	0 = Off 1 = On	COS 1 ~ 15 = 0		✓	
20-13-02	<b>Class of Service Options (Supplementary Service) – Long Conversation Cutoff (Incoming)</b> Turn Off or On an extension user ability to use Long Conversation Cutoff for incoming calls.	0 = Off 1 = On	COS 1 ~ 15 = 0		✓	
20-13-03	<b>Class of Service Options (Supplementary Service) – Long Conversation Cutoff (Outgoing)</b> Turn Off or On an extension user ability to use Long Conversation Cutoff for outgoing calls.	0 = Off 1 = On	COS 1 ~ 15 = 0		✓	

Program Number	Program Name/Description	Input Data	Default	Level		
				1	2	3
20-13-04	<b>Class of Service Options (Supplementary Service) – Call Forward/DND Override (Bypass Call)</b> Turn Off or On an extension user ability to use Call Forwarding/DND Override.	0 = Off 1 = On	COS 1 ~ 15 = 1		✓	
20-13-05	<b>Class of Service Options (Supplementary Service) – Intercom Off-Hook Signaling</b> Turn Off or On an extension ability to send off-hook signals.	0 = Off 1 = On	COS 1 ~ 15 = 1		✓	
20-13-06	<b>Class of Service Options (Supplementary Service) – Automatic Off-Hook Signaling (Automatic Override)</b> Allow a busy extension to Manually (0) or Automatically (1) receive off-hook signals. ➡ <i>This setting is to receive incoming call signaling information during call queuing.</i>	0 = Off 1 = On	COS 1 ~ 15 = 1		✓	
20-13-07	<b>Class of Service Options (Supplementary Service) – Message Waiting</b> Turn Off or On an extension user ability to leave Message Waiting.	0 = Off 1 = On	COS 1 ~ 15 = 1		✓	
20-13-12	<b>Class of Service Options (Supplementary Service) – Room Monitor, Extension Being Monitored</b> Turn Off or On an extension user ability to be monitored by other extensions.	0 = Off 1 = On	COS 1 ~ 15 = 0		✓	
20-13-13	<b>Class of Service Options (Supplementary Service) – Continued Dialing (DTMF) Signal on ICM Call</b> Turn Off or On an extension user ability to use Continued Dialing, which allows DTMF signal sending while talking on extension.	0 = Off 1 = On	COS 1 ~ 15 = 1		✓	
20-13-16	<b>Class of Service Options (Supplementary Service) – Barge-In, Receive</b> Turn Off or On an extension user ability to Barge-In on calls.	0 = Off 1 = On	COS 1 ~ 15 = 0		✓	
20-13-28	<b>Class of Service Options (Supplementary Service) – Allow Class of Service to be Changed</b> Turn Off or On an extension user ability to change COS via Service Code 677.	0 = Off 1 = On	COS 1 ~ 15 = 0		✓	
20-13-35	<b>Class of Service Options (Supplementary Service) – Block Camp On</b> Turn Off or On an extension user ability to block callers from dialing to camp-on.	0 = Off 1 = On	COS 1 ~ 15 = 0		✓	

Program Number	Program Name/Description	Input Data	Default	Level		
				1	2	3
22-02-01	<b>Incoming Call Trunk Setup – Incoming Type</b> Assign the incoming trunk type for each trunk. There is one item for each Mode. When using Trunk-to-Trunk Forwarding the trunk must be set to 0.	0 = Normal 1 = VRS (second dial tone if no VRS installed) 2 = DISA 3 = DID 4 = DIL 5 = E&M Tie line 6 = Delayed VRS 7 = ANI/DNIS 8 = DID(DDI) Mode Switching	0		✓	
22-04-01	<b>Incoming Extension Ring Group Assignment</b> Assign extensions (up to 48) to Ring Groups. Calls ring extensions according to Ring Group programming.	Maximum of eight digits.	Extensions 101 ~ 108 (first eight ports) ring for incoming Ring Group 1 calls. No other extensions ring for incoming Ring Group 1 calls.		✓	
22-07-01	<b>DIL Assignment</b> Assign the destination extension for each DIL incoming trunk (001 ~ 400). ➡ For this selection to work, set Program 22-02-01 to 4 = DIL.	Day/Night Modes (1 ~ 8): Extension Number (maximum of eight digits) Pilot Number	No Setting		✓	
22-08-01	<b>DIL/IRG No Answer Destination</b> For Voice Mail Overflow, enter the Ring Group that unanswered DILs to Voice Mail ring after the DIL Call Waiting time (Program 22-01-04).	0 (No Setting) 001 ~ 100 (Incoming Ring Group) 102 (In-Skin/ External Voice Mail or InMail)	1		✓	
24-02-02	<b>System Options for Transfer – MOH or Ringback on Transferred Calls</b> Enable (0)/Disable (1) MOH on Transfer. If enabled, a transferred caller hears Music on Hold while their call rings the destination extension. If disabled, a transferred caller hears ringback while their call rings the destination extension. For this option to work with voice mail, the transferred call must be an unscreened transfer.	0 = Hold Tone 1 = Ring Back Tone	0		✓	
24-02-03	<b>System Options for Transfer – Delayed Call Forwarding Time</b> Set the time a transferred call waits at an extension forwarded to Voice Mail before routing to the called extension mailbox.	0 ~ 64800 seconds	10		✓	

Program Number	Program Name/Description	Input Data	Default	Level		
				1	2	3
40-07-01	<b>Voice Prompt Language Assignment for VRS</b> Specify the language to be used for the VRS prompts.	1 = US English 2 = UK English 3 = AU English 4 = CA French 5 = Dutch 6 = Mex Spanish 7 = LA Spanish 8 = Italian 9 = German 10 = ES Spanish 11 = Norwegian 12 = ParisFrench 13 = BR Portugue 14 = Japanese 15 = MandChinese 16 = Korean 17 = IB Portugue 18 = Greek 19 = Danish 20 = Swedish 21 = Thai 22 = Taiwan 23 = Flemish 24 = Turkish 25 = Reserved 26 = Russian	1		✓	
45-01-01	<b>Voice Mail Integration Options – Voice Mail Department Group Number</b> Assign which Extension (Department) Group number is assigned as the voice mail group. An entry of 0 means no voice mail is installed.	Department Groups: 0 ~ 64 0 = No Voice Mail	0	✓		
45-01-02	<b>Voice Mail Integration Options – Voice Mail Master Name</b> Enter the Voice Mail master name up to 12 characters.	Maximum of 12 characters.	VOICE MAIL		✓	
45-01-04	<b>Voice Mail Integration Options – Park and Page</b> Turn Off or On the system ability to process the Voice Mail Park and Page (*) commands. You should normally enable this option.	0 = Off 1 = On	1		✓	

Program Number	Program Name/Description	Input Data	Default	Level		
				1	2	3
45-01-05	<b>Voice Mail Integration Options – Message Wait</b> Turn Off or On the system ability to process the Voice Mail Message Wait (#) commands. You should normally <i>enable</i> this option. If enabled, be sure that the programmed Message Notification strings do not contain the code #9 for trunk access. When using an external voice mail and Centrex transfer, this option should be disabled or the service code #3 in Program 11-12-42 must be changed.	0 = Off 1 = On	1		✓	
45-01-06	<b>Voice Mail Integration Options – Record Alert Tone Interval Time</b> Set the time between Voice Mail Conversation Record alerts.	0 ~ 64800 seconds	30		✓	
45-01-14	<b>Voice Mail Integration Options – CCIS Centralized Voice Mail Number</b> Assign the pilot number to Centralized Voice Mail over CCIS Link. Assign this only in the remote switches.	Maximum of eight digits.	No Setting		✓	
45-01-15	<b>Voice Mail Integration Options – Analog Voice Mail Protocol Selection</b> Assign whether Fixed codes or the codes used in Program 45-04 are used for analog voice mail protocol.	0: Fixed 1: Program	0		✓	
45-01-16	<b>Voice Mail Integration Options – Voice Mail FAX Digit Add Assignment</b> Assign up to four digits in front of the station number sent to the SLT port when a call is forwarded.	Maximum of four digits.	No Setting		✓	
45-01-17	<b>Voice Mail Integration Options – Reply Mail Box Number</b> Set whether or not to include the mailbox number in the analog voice mail protocol.	0 = No 1 = Yes	1		✓	
45-01-18	<b>Voice Mail Integration Options – Trunk Number Mapping</b> Assign the digits of trunk number mapping.	2 ~ 3	2		✓	
45-04-01	<b>Voice Mail Digit Add Assignment – Remote Logon (Internal)</b> Define the digits for remote Logon (internal).	Maximum of four digits.	No Setting		✓	
45-04-02	<b>Voice Mail Digit Add Assignment – Direct Logon</b> Define the digits for direct Logon.	Maximum of four digits.	No Setting		✓	
45-04-03	<b>Voice Mail Digit Add Assignment – Transfer Message</b> Define the digits for transfer message.	Maximum of four digits.	No Setting		✓	

Program Number	Program Name/Description	Input Data	Default	Level		
				1	2	3
45-04-04	<b>Voice Mail Digit Add Assignment – Forward-All</b> Define the digits for forward all.	Maximum of four digits.	No Setting		✓	
45-04-05	<b>Voice Mail Digit Add Assignment – Forward-Busy</b> Define the digits for forward busy.	Maximum of four digits.	No Setting		✓	
45-04-06	<b>Voice Mail Digit Add Assignment – Forward RNA</b> Define the digits for forward RNA.	Maximum of four digits.	No Setting		✓	
45-04-07	<b>Voice Mail Digit Add Assignment – Remote Logon</b> Define the digits for remote Logon.	Maximum of four digits.	No Setting		✓	
45-04-08	<b>Voice Mail Digit Add Assignment – Conversation Recording</b> Define the digits for conversation recording.	Maximum of four digits.	No Setting		✓	
45-04-09	<b>Voice Mail Digit Add Assignment – Clear Down String</b> Define the digits for clear down string.	Maximum of four digits.	No Setting		✓	
45-05-01	<b>Voice Mail Send Protocol Signal Without Additional Digits – Remote Log-On Internal</b> Send trunk number and/or station number information if integrating to Voice Mail when Program 45-04-XX is left blank and 45-01-15 is set to Program.	0:Off 1:On	0		✓	
45-05-02	<b>Voice Mail Send Protocol Signal Without Additional Digits – Direct Log-On</b> Send trunk number and/or station number information if integrating to Voice Mail when Program 45-04-XX is left blank and 45-01-15 is set to Program.	0:Off 1:On	0		✓	
45-05-03	<b>Voice Mail Send Protocol Signal Without Additional Digits – Transfer Message/QVM</b> Send trunk number and/or station number information if integrating to Voice Mail when Program 45-04-XX is left blank and 45-01-15 is set to Program.	0:Off 1:On	0		✓	
45-05-04	<b>Voice Mail Send Protocol Signal Without Additional Digits – Forward-All</b> Send trunk number and/or station number information if integrating to Voice Mail when Program 45-04-XX is left blank and 45-01-15 is set to Program.	0:Off 1:On	0		✓	
45-05-05	<b>Voice Mail Send Protocol Signal Without Additional Digits – Forward-Busy</b> Send trunk number and/or station number information if integrating to Voice Mail when Program 45-04-XX is left blank and 45-01-15 is set to Program.	0:Off 1:On	0		✓	



Program Number	Program Name/Description	Input Data	Default	Level		
				1	2	3
45-05-06	<b>Voice Mail Send Protocol Signal Without Additional Digits – Forward RNA</b> Send trunk number and/or station number information if integrating to Voice Mail when Program 45-04-XX is left blank and 45-01-15 is set to Program.	0:Off 1:On	0		✓	
45-05-07	<b>Voice Mail Send Protocol Signal Without Additional Digits – Remote Log-On</b> Send trunk number and/or station number information if integrating to Voice Mail when Program 45-04-XX is left blank and 45-01-15 is set to Program.	0:Off 1:On	0		✓	
45-05-08	<b>Voice Mail Send Protocol Signal Without Additional Digits – Conversation Recording</b> Send trunk number and/or station number information if integrating to Voice Mail when Program 45-04-XX is left blank and 45-01-15 is set to Program.	0:Off 1:On	0		✓	
45-05-09	<b>Voice Mail Send Protocol Signal Without Additional Digits – Clear Down String</b> Send trunk number and/or station number information if integrating to Voice Mail when Program 45-04-XX is left blank and 45-01-15 is set to Program.	0:Off 1:On	0		✓	
80-03-01	<b>DTMF Tone Receiver Setup – Detect Level</b> Define the Detect Level for DTMF Tone Receiver.	0 = 0dBm ~ -25dBm 1 = -5dBm ~ -30dBm 2 = -10dBm ~ -35dBm 3 = -15dBm ~ -40dBm 4 = -20dBm ~ -45dBm 5 = -25dBm ~ -50dBm 6 = -30dBm ~ -55dBm	Type 1 ~ 5 = 0			✓
80-03-02	<b>DTMF Tone Receiver Setup – Start Delay Time</b> Customize the Start delay time for DTMF Tone Receivers.	0 ~ 255 (0.25ms ~ 64ms)	Type 1 ~ 5 = 0			✓

Program Number	Program Name/Description	Input Data	Default	Level		
				1	2	3
80-03-03	<b>DTMF Tone Receiver Setup – Min. Detect Level</b> Define the various minimum detect levels for the DTMF Tone Receiver.	0 ~ 15 detect level 0: -10dBm(0) to -25dBm(15) detect level 1: -15dBm(0) to -30dBm(15) detect level 2: -20dBm(0) to -35dBm(15) detect level 3: -25dBm(0) to -40dBm(15) detect level 4: -30dBm(0) to -45dBm(15) detect level 5: -35dBm(0) to -50dBm(15) detect level 6: -40dBm(0) to -55dBm(15) detect level 7: -45dBm(0) to -60dBm(15) detect level 8: -50dBm(0) to -65dBm(15) detect level 9: -55dBm(0) to -70dBm(15) detect level 10: -60dBm(0) to -75dBm(15) detect level 11: -65dBm(0) to -80dBm(15) detect level 12: -70dBm(0) to -85dBm(15) detect level 13: -75dBm(0) to -90dBm(15) detect level 14: -80dBm(0) to -95dBm(15) detect level 15: -85dBm(0) to -100dBm(15)	Type 1 = 10 (-20dBm) Type 2 ~ 3 = 15 (-25dBm) Type 4 ~ 5 = 10 (-20dBm)			✓

Program Number	Program Name/Description	Input Data	Default	Level		
				1	2	3
80-03-04	<b>DTMF Tone Receiver Setup – Max. Detect Level</b> Define the various maximum detect levels for the DTMF Tone Receiver.	0 ~ 15 detect level 0: 0dBm(0) to -15dBm(15) detect level 1: -5dBm(0) to -20dBm(15) detect level 2: -10dBm(0) to -25dBm(15) detect level 3: -15dBm(0) to -30dBm(15) detect level 4: -20dBm(0) to -35dBm(15) detect level 5: -25dBm(0) to -40dBm(15) detect level 6: -30dBm(0) to -45dBm(15) detect level 7: -35dBm(0) to -50dBm(15) detect level 8: -40dBm(0) to -55dBm(15) detect level 9: -45dBm(0) to -60dBm(15) detect level 10: -50dBm(0) to -65dBm(15) detect level 11: -55dBm(0) to -70dBm(15) detect level 12: -60dBm(0) to -75dBm(15) detect level 13: -65dBm(0) to -80dBm(15) detect level 14: -70dBm(0) to -85dBm(15) detect level 15: -75dBm(0) to -90dBm(15)	Type 1 ~ 5 = 2 (-2dBm)			✓
80-03-05	<b>DTMF Tone Receiver Setup – Forward Twist Level</b> Define the various forward twist levels for the DTMF Tone Receiver.	0 ~ 9 (1dB ~ 10dB)	Type 1 ~ 5 = 5 (6dBm)			✓
80-03-06	<b>DTMF Tone Receiver Setup – Backward Twist Level</b> Define the various backward twist levels for the DTMF Tone Receiver.	0 ~ 9 (1dB ~ 10dB)	Type 1 ~ 5 = 0 (1dBm)			✓

Program Number	Program Name/Description	Input Data	Default	Level		
				1	2	3
80-03-07	<b>DTMF Tone Receiver Setup – ON Detect Time</b> Define the on detect time for the DTMF Tone Receiver.	1 ~ 255 (15+ 15m s~ 3825ms)	<b>Version 1000</b> Type 1 ~ 5 = 1 (30ms)			✓
			<b>Version 3000 or higher</b> Type 1 ~ 5 = 3 (60ms)			
80-03-08	<b>DTMF Tone Receiver Setup – OFF Detect Time</b> Define the off detect time for the DTMF Tone Receiver.	1 ~ 255 (15+ 15ms ~ 3825ms)	<b>Version 1000</b> Type 1 ~ 5 = 1 (30ms)			✓
			<b>Version 3000 or higher</b> Type 1 ~ 5 = 2 (45ms)			
80-04-01	<b>Call Progress Tone Detector Setup – Detection Level</b> Define the detection levels for the Call Progress Tone Detector.	0 = 0dBm ~ -25dBm 1 = -5dBm ~ -30dBm 2 = -10dBm ~ -35dBm 3 = -15dBm ~ -40dBm 4 = -20dBm ~ -45dBm 5 = -25dBm ~ -50dBm 6 = -30dBm ~ -55dBm	default: Type 1 (DT) – 0 (-25dBm) Type 2 (BT) – 0 (-25dBm) Type 3 (RBT) – 0 (-25dBm) Type 4, Type 5 – 0			✓
80-04-02	<b>Call Progress Tone Detector Setup – Min. Detection Level</b> Define the minimum detection levels for the Call Progress Tone Detector.	0 ~ 15 detect level 0: -15dBm (0) to -30dBm(15) detect level 1: -30dBm (0) to -45dBm(15) detect level 2: -40dBm (0) to -55dBm(15)	<b>Version 1000</b> Type 1 (DT) – 15 (-25dBm) Type 2 (BT) – 15 (-25dBm) Type 3 (RBT) – 15 (-25dBm) Type 4, Type 5 – 0			✓
			<b>Version 3000 or higher</b> Type 1 (DT) – 15 (-25dBm) Type 2 (BT) – 15 (-25dBm) Type 3 (RBT) – 15 (-25dBm) Type 4 – 0 Type 5 – 1			

Program Number	Program Name/Description	Input Data	Default	Level		
				1	2	3
80-04-03	<b>Call Progress Tone Detector Setup – S/N Ratio</b> Define the S/N ratio for the Call Progress Tone Detector.	0 ~ 4 (0dB ~ -20dB)	Type 1 (DT) – 4 (-20dB) Type 2 (BT) – 4 (-20dB) Type 3 (RBT) – 4 (-20dB) Type 4, Type 5 – 0			✓
80-04-04	<b>Call Progress Tone Detector Setup – No Tone Time</b> Define the no tone time for the Call Progress Tone Detector.	0 ~ 255 (30 + 30 ~ 7680ms) (0 = not detect) 1 ~ 255 = 60 ~ 7680ms The formula is 30 + 30N. When set to N = 1, it means 30 + 30 * 1 = 60. When set to N=255, it means 30+30*255=7680	Type 1 (DT) – 132 (3990ms) Type 2 (BT) – 132 (3990ms) Type 3 (RBT) – 132 (3990ms) Type 4, Type 5 – 0			✓
80-04-05	<b>Call Progress Tone Detector Setup – Pulse Count</b> Define the pulse count for the Call Progress Tone Detector.	1 ~ 255	Type 1 (DT) – 1 Type 2 (BT) – 1 Type 3 (RBT) – 1 Type 4, Type 5 – 0			✓
80-04-06	<b>Call Progress Tone Detector Setup – ON Minimum Time</b> Define the on minimum time for the Call Progress Tone Detector.	1 ~ 255 (30 + 30 ~ 7680ms)	<b>Version 1000</b> Type 1 (DT) – 9 (300ms) Type 2 (BT) – 12 (300ms) Type 3 (RBT) – 25 (780ms) Type 4, Type 5 – 0  <b>Version 3000 or higher</b> Type 1 (DT) – 45 (300ms) Type 2 (BT) – 12 (300ms) Type 3 (RBT) – 25 (780ms) Type 4 – 0 Type 5 – 5			✓

Program Number	Program Name/Description	Input Data	Default	Level		
				1	2	3
80-04-07	<b>Call Progress Tone Detector Setup – ON Maximum Time</b> Define the on maximum time for the Call Progress Tone Detector.	0 ~ 255 (30 + 30 ~ 7680ms)	<b>Version 1000</b> Type 1 (DT) – 0 Type 2 (BT) – 20 (630ms) [ET] Type 3 (RBT) – 40 1230ms Type 4, Type 5 – 0			
			<b>Version 3000 or higher</b> Type 1 (DT) – 0 Type 2 (BT) – 20 (630ms) [ET] Type 3 (RBT) – 40 1230ms Type 4 – 0 Type 5 – 15			✓
80-04-08	<b>Call Progress Tone Detector Setup – OFF Minimum Time</b> Define the off minimum time for the Call Progress Tone Detector.	1 ~ 255 (30 + 30 ~ 7680ms)	Type 1 (DT) – 1 (60ms) Type 2 (BT) – 12 (300ms) Type 3 (RBT) – 83 (2520ms) Type 4, Type 5 – 0			✓
80-04-09	<b>Call Progress Tone Detector Setup – OFF Maximum Time</b> Define the off maximum time for the Call Progress Tone Detector.	0 ~ 255 (30 + 30 ~ 7680ms)	Type 1 (DT) – 1 (60ms) Type 2 (BT) – 20 (450ms) Type 3 (RBT) – 115 (3480ms) Type 4, Type 5 – 0			✓

## Operation

### Calling your Mailbox

#### To call your mailbox:

##### Multiline Terminal

1. Press your **Voice Mail** key (Program 15-07 or SC 751: 77) or the **Message** key.  
- OR -  
Press **Speaker** and dial the Voice Mail Master Number. After Voice Mail Answers, dial your mailbox number.
  - ◇ *Your mailbox number is normally the same as your extension number. You may optionally dial a co-worker's mailbox - or use this procedure to call your mailbox from a co-worker's telephone.*- OR -  
Press **Speaker** and dial **\*8**.
2. If requested by Voice Mail, enter your security code.
  - ◇ *Ask your Voice Mail system administrator for your security code.*
  - ◇ *Normally, your Message Waiting LED goes out (if applicable). If it continues to flash, you have unanswered Message Waiting requests or a new General Message. Refer to [Checking Messages on page 2-689](#).*

##### Single Line Telephone

1. Lift the handset and dial **\*8**.
  - ◇ *If you are at a co-worker's telephone, you can dial the Voice Mail master number and your mailbox number instead. You can also use this procedure from your own telephone to call a co-worker's mailbox.*
2. If requested by Voice Mail, enter your security code.

### Checking Messages:

1. Press the **Message** key once.
  - ◇ *The voice mail is called.*
  - ◇ *When there are new messages, the Large LED on the telephone flashes red.*
  - ◇ *With this option set, the MSG key can be used as a Voice Mail key for any function [calling voice mail or transfer call a to voice mail (Hold + MSG + Extension Number), etc.].*

## Recording your Call

### To record your active call in your mailbox:

#### Multiline Terminal

1. Press **Voice Mail Record** key (Program 15-07 or SC 751: code 78).
  - ◇ *You hear two beeps and your Record key flashes. The beeps periodically repeat to remind you that you are recording.*
  - ◇ *To stop recording, press the Voice Mail Record key again. You can restart and stop recording as required.*

**- OR -**

1. Press **Hold**.
2. Dial **654**.
  - ◇ *The system automatically reconnects you to your call.*
  - ◇ *To stop recording, place the call on hold then pick the call back up. You can restart and stop recording as required.*

#### Single Line Telephone

1. Hookflash.
2. Dial **654**.
  - ◇ *The system automatically reconnects you to your call.*
  - ◇ *To stop recording, hookflash twice. You can restart and stop recording as required.*



## Voice Mail Message Indication on Line Keys

### Description

Voice Mail Message Indication on Line Keys indicates a new voice mail message on Line Keys or DSS/BLF keys.

#### Conditions

- When a DSS key of an installed extension is pressed when flashing that extension is called.
- You have to use a VM Message key (code 77) to get the indication when there is a new message. It can be used also for installed extensions.
- VM Message key calls the VM and logs into the mail box.
- If a VM Message key for extension A is placed on extension A, the Large LED does not light on extension A for new message indication. Instead the VM Message key flashes green.
- VM message LED is a higher priority then any other status for the DSS/BLF key.
- The enabling or disabling of Voice Mail Indication on BLF enables the station with the message to show up on other telephones. It does not enable/disable stations from seeing the BLF indication.
- Virtual Extension Keys assigned as code \*03 do not support Voice Mail Message Indication on Line Keys.

#### Default Settings

Not allowed

### System Availability

#### Terminals

All Multiline Terminals

#### Required Component(s)

VM (Digital or Analog)

## Related Features

- ➔ [Class of Service](#)
- ➔ [Direct Station Selection \(DSS\) Console](#)
- ➔ [Programmable Function Keys](#)
- ➔ [UM8000 Mail](#)
- ➔ [InMail](#)
- ➔ [Voice Mail Integration \(Analog\)](#)

## Guide to Feature Programming

The **Level 1**, **Level 2** and **Level 3** columns indicate the programs that are assigned when programming this feature in the order they are most commonly used. These levels are used with PCPro and WebPro wizards for feature programming.

- Level 1 – these are the most commonly assigned programs for this feature.
- Level 2 – these are the next most commonly assigned programs for this feature.
- Level 3 – these programs are not often assigned and require an expert level working knowledge of the system to be properly assigned.

Program Number	Program Name/Description	Input Data	Default	Level		
				1	2	3
15-07-01	<b>Programmable Function Keys</b> Assign DSS/BLF function keys on Multiline telephones (code 01 + extension number) or Message Key (Code 77 + mailbox number).	Line Key 1 ~ 48 0 ~ 99 (Normal Function Code 751 by default) *00 ~ *99 (Appearance Function Code) (Service Code 752 by default)	Refer to the Programming Manual for default values.	✓		
20-13-41	<b>Class of Service Options (Supplementary Service) – Voice Mail Message Indication on DSS</b> Turn Off or On the Voice Mail Message Indication for an extension on a DSS console.	0 = Off 1 = On	COS 1 ~ 15 = 0	✓		
30-01-01	<b>DSS Console Operating Mode</b> Set the system DSS consoles mode.	0 = Business Mode 1 = Hotel Mode 2 = Monitor Mode 3 = Business/ Mode	0		✓	
30-02-01	<b>DSS Console Extension Assignment – Extension Number</b> Enter the extension number for the multiline terminal connected with the DSS console (up to eight digits).	Maximum of eight digits.	No Setting	✓		

Program Number	Program Name/Description	Input Data	Default	Level		
				1	2	3
30-03-01	<b>DSS Console Key Assignment</b> Customize DSS console keys to function as DSS keys, Service Code keys, Programmable Function Keys, and One-Touch Calling keys. The key (when defined as a DSS/One-Touch key [code 01] can have any function with up to four digits (e.g., extension number or Service Code). The function information (such as extension number or Service Code) would then be entered as additional data.	Key Number 001 ~ 114 0 ~ 99 (General Functional Level) 97 = Door Box Access key (additional data: 1 ~ 8 Door Box No.) * 00 ~ * 99 (Appearance Functional Level)	Refer to the Programming Manual for default values.	✓		
30-05-02	<b>DSS Console Lamp Table – Busy Extension</b> Define the LED patterns for busy extension functions on the DSS consoles.	0 ~ 7	7 (On)			✓
30-05-03	<b>DSS Console Lamp Table – DND Extension</b> Define the LED patterns for DND extension functions on the DSS consoles.	0 ~ 7	3 (RW)			✓
30-05-04	<b>DSS Console Lamp Table – Agent Busy</b> Define the LED patterns for agent busy functions on the DSS consoles.	0 ~ 7	7 (On)			✓
30-05-05	<b>DSS Console Lamp Table – Out of Schedule ( DSS)</b> Define the LED patterns for out of schedule (/ DSS) functions on the DSS consoles.	0 ~ 7	0 (Off)			✓
30-05-06	<b>DSS Console Lamp Table – Agent Log Out ( DSS)</b> Define the LED patterns for agent log out (/ DSS) functions on the DSS consoles.	0 ~ 7	5 (IL)			v
30-05-07	<b>DSS Console Lamp Table – Agent Log In ( DSS)</b> Define the LED patterns for agent login (/DSS) functions on the DSS consoles.	0 ~ 7	4 (IR)			✓
30-05-08	<b>DSS Console Lamp Table – Agent Emergency ( DSS)</b> Define the LED patterns for agent emergency (/DSS) functions on the DSS consoles.	0 ~ 7	6 (IW)			✓
30-05-09	<b>DSS Console Lamp Table – Hotel Status Code 1 (Hotel DSS)</b> Define the LED patterns for hotel status code 1 (hotel DSS) functions on the DSS consoles.	0 ~ 7	7 (On)			✓
30-05-10	<b>DSS Console Lamp Table – Hotel Status Code 2 (Hotel DSS)</b> Define the LED patterns for hotel status code 2 (hotel DSS) functions on the DSS consoles.	0 ~ 7	1 (FL)			✓
30-05-11	<b>DSS Console Lamp Table – Hotel Status Code 3 (Hotel DSS)</b> Define the LED patterns for hotel status code 3 (hotel DSS) functions on the DSS consoles.	0 ~ 7	2 (WK)			✓

Program Number	Program Name/Description	Input Data	Default	Level		
				1	2	3
30-05-12	<b>DSS Console Lamp Table – Hotel Status Code 4 (Hotel DSS)</b> Define the LED patterns for hotel status code 4 (hotel DSS) functions on the DSS consoles.	0 ~ 7	3 (RW)			✓
30-05-13	<b>DSS Console Lamp Table – Hotel Status Code 5 (Hotel DSS)</b> Define the LED patterns for hotel status code 5 (hotel DSS) functions on the DSS consoles.	0 ~ 7	5 (IL)			✓
30-05-14	<b>DSS Console Lamp Table – Hotel Status Code 6 (Hotel DSS)</b> Define the LED patterns for hotel status code 6 (hotel DSS) functions on the DSS consoles.	0 ~ 7	3 (RW)			✓
30-05-15	<b>DSS Console Lamp Table – Hotel Status Code 7 (Hotel DSS)</b> Define the LED patterns for hotel status code 7 (hotel DSS) functions on the DSS consoles.	0 ~ 7	6 (IW)			✓
30-05-16	<b>DSS Console Lamp Table – Hotel Status Code 8 (Hotel DSS)</b> Define the LED patterns for hotel status code 8 (hotel DSS) functions on the DSS consoles.	0 ~ 7	4 (IR)			✓
30-05-17	<b>DSS Console Lamp Table – Hotel Status Code 9 (Hotel DSS)</b> Define the LED patterns for hotel status code 9 (hotel DSS) functions on the DSS consoles.	0 ~ 7	3 (RW)			✓
30-05-18	<b>DSS Console Lamp Table – Hotel Status Code 0 (Hotel DSS)</b> Define the LED patterns for hotel status code 0 (hotel DSS) functions on the DSS consoles.	0 ~ 7	0 (Off)			✓
30-05-19	<b>DSS Console Lamp Table – Hotel Status Code * (Hotel DSS)</b> Define the LED patterns for hotel status code * (hotel DSS) functions on the DSS consoles.	0 ~ 7	4 (IR)			✓
30-05-20	<b>DSS Console Lamp Table – Hotel Status Code # (Hotel DSS)</b> Define the LED patterns for hotel status code # (hotel DSS) functions on the DSS consoles.	0 ~ 7	5 (IL)			✓
30-05-21	<b>DSS Console Lamp Table – VM Message Indication</b> Define the LED patterns for VM message indication functions on the DSS consoles.	0 ~ 7	3 (RW)			✓

## Operation

### To program a DSS/BLF key on a telephone:

1. Press **Speaker**.
2. Dial **751**.
3. Press the key you want to program.
4. Dial **01**.
5. Dial the number of the extension you want to appear on the key.
6. Press **Hold**.
7. Press **Speaker**.

### To program a VM Message key on a telephone:

1. Press **Speaker**.
2. Dial **751**.
3. Press the key you want to program.
4. Dial **77**.
5. Dial the number of the extension you want to appear on the key.
6. Press **Speaker**.

## Description

Voice Over lets a user interrupt a busy station user that is on another call. With Voice Over, the busy extension user hears an alert tone followed by the voice of the interrupting party. The extension user receiving the Voice Over can respond to the interrupting party without being heard by the original caller. If desired, the user can easily switch between their original caller and the interrupting co-worker. The original caller and the interrupting party can never hear each other.

### EXAMPLE:

Voice Over could help a lawyer waiting for an urgent call. While on a call with another client, the lawyer's paralegal could announce the urgent call as soon as it comes in. The lawyer could then give the paralegal instructions how to handle the situation – all without the original client hearing the conversation.

Both multiline terminal users and 500/2500 set users can initiate and receive a Voice Over.

To enable Voice Over, a multiline terminal can have a function key programmed for Voice Over. In addition to one-touch Voice Over operation, the key shows the Voice Over status as follows:

When the key is . . .	You are . . .
Off	Not using Voice Over
Flashing (Red)	Listening to the interrupting party
On (Green)	Responding to the interrupting party

## Conditions

- While active, Voice Over uses a Conference circuit on a GCD-CP10. Refer to the Conference feature for Conference circuit programming.
- Voice Over can interrupt a trunk call only if the trunk is set up for at least six seconds.
- Do not use Voice Over to a user on speakerphone as the conversation may be heard by the outside party.
- When a multiline terminal user performs Voice Over, the speech path is 1-way from the originator to the destination.
- The Voice Over Access Code can be assigned on a Programmable Function Key.
- An override tone is sent to both calling and called parties. A single line telephone user can receive Voice Over. After a Tone Override is heard, Voice Over can be set.
- When a Programmable Function Key (programmed with the Voice Over Access Code) is pressed, the LED lights while responding to the page.

- When a multiline terminal has a Handsfree Unit programmed, the Voice Over call can be received and answered handsfree.
- When Data Line Security is assigned to a station, the Voice Over to the station is disabled.
- An extension user cannot Voice Over to another extension user in a Conference.
- If you place a call on hold and then Voice Over to a busy extension, the call on hold does not transfer to the busy party when you end the Voice Over.
- A station can receive only one Voice Over at a time.
- A multiline terminal user cannot answer a Voice Over with an internal call on hold.
- An attempt to Voice Over a station can be denied if the station is in DND (Do Not Disturb) Mode, Automatic Redial is activated, during Station Programming, during Incoming Ringing, during Internal/External Paging, during a Conference Call, during a conference call on hold, the terminal is on internal hold, or the terminal has a call on internal hold.
- When a single line telephone is on a call and Voice Over is presented, the single line telephone cannot talk back to the party that originated the Voice Over.
- Voice Over to a single line telephone is not recommended because cross talk is inherent in the side tone of analog telephones.
- Voice Over to a user on speakerphone is not recommended because the conversation may be heard by the outside party.
- Answering a Voice Over requires a uniquely programmed Voice Over key.

### Default Settings

Disabled

## System Availability

### Terminals

All Multiline Terminals and Single Line Telephones

### Required Component(s)

None

## Related Features

- ➔ **Conference**
- ➔ **Off-Hook Signaling**
- ➔ **Programmable Function Keys**

## Guide to Feature Programming

The **Level 1**, **Level 2** and **Level 3** columns indicate the programs that are assigned when programming this feature in the order they are most commonly used. These levels are used with PCPro and WebPro wizards for feature programming.

- Level 1 – these are the most commonly assigned programs for this feature.
- Level 2 – these are the next most commonly assigned programs for this feature.
- Level 3 – these programs are not often assigned and require an expert level working knowledge of the system to be properly assigned.

Program Number	Program Name/Description	Input Data	Default	Level		
				1	2	3
<b>11-12-41</b>	<b>Service Code Setup (for System Access) – Voice Over</b> Set the service code used for the Voice Over feature. ➔ <i>To use Service Code 690 for Voice Over, Program 11-16-08 (Single Digit Service Code Setup – Voice Over) must be undefined.</i>	MLT 0 ~ 9, *, # Maximum of eight digits	690		✓	
<b>11-16-08</b>	<b>Single Digit Service Code Setup – Voice Over</b> Set the Service code used for the Voice Over feature.	0 ~ 9, *, # Maximum of one digit	6		✓	
<b>15-07-01</b>	<b>Programmable Function Keys</b> Assign a function key for Voice Over (code 48).	Line Key 1 ~ 48 0 ~ 99 (Normal Function Code 751 by default) *00 ~ *99 (Appearance Function Code) (Service Code 752 by default)	Refer to the Programming Manual for default values.		✓	
<b>20-06-01</b>	<b>Class of Service for Extensions</b> Assign a Class of Service (1 ~ 15) to an extension.	Day Night/Mode: 1 ~ 8 Class of Service of Extensions (1 ~ 15)	Extension port 101 = Class 15 All other extension port = Class 1	✓		



Program Number	Program Name/Description	Input Data	Default	Level		
				1	2	3
20-13-06	<p><b>Class of Service Options (Supplementary Service) – Automatic Off-Hook Signaling (Automatic Override)</b></p> <p>Allow a busy extension to Manually (0) or Automatically (1) receive off-hook signals.</p> <p>➡ <i>This setting is to receive incoming call signaling information during call queuing.</i></p>	<p>0 = Off 1 = On</p>	COS 1 ~ 15 = 1	✓		
21-01-03	<p><b>System Options for Outgoing Calls – Trunk Interdigit Time (External)</b></p> <p>Program the time an extension must wait before using the Voice Over feature can be used on a call (this time expires before putting a call in a talk state). This time also affects Barge-In.</p>	0 ~ 64800 seconds	5		✓	

## Operation

### To initiate a Voice Over to a busy extension:

- Press Voice Over key (Program 15-07 or SC 751: 48)
  - OR -
  - Dial **6**.
  - OR -
  - Dial **690**.
  - ◇ *You hear an alert tone and the Voice Over key flashes. You can talk to the called party after the alert tone ends.*
  - ◇ *To use Service Code 690 for Voice Over, Program 11-16-08 (Voice Over Service Code) must be undefined.*

### To respond to a Voice Over alert tone to your extension:



*You can respond only if you have a Voice Over key.*

NOTE

- Press the Voice Over key.
  - ◇ *The Voice Over key lights steady (green), and you can talk to the interrupting party.*
  - ◇ *You cannot respond by dialing the Voice Over Service Code (6).*

**To return to your original call:**

1. Press the Voice Over key.
2. Press the Voice Over key again.
  - ◇ *Your Voice Over key flashes red when you are talking to your original call.*
  - ◇ *To switch between your original call and the interrupting party, just keep pressing the Voice Over key.*

## Voice Response System (VRS)

### Description

With appropriate licensing the SV9100 provides the option for the Voice Response System (VRS) which gives the system voice recording and playback ability. The VRS SD card provides up to 100 system messages (General Message, Automated Attendant greetings, messages, and the 900 Preamble).

- General Message** – provides a recorded message to which any user can listen
- Automated Attendant (Operator Assistance)** – answers incoming calls, plays a greeting to the caller and then lets the caller directly dial a system extension
- Messages** – provides announcement and overflow messages for groups
- Transfer to the VRS** – allows any extension user to Transfer their outside call to the VRS
- Voice Prompting Messages** – plays call and feature status messages to users
- 900 Preamble** – alerts callers using 900 lines of the cost and features of the pay-per-call service
- Time, Date and Station Number Check** – lets a multiline terminal extension user quickly hear a recording for the time, date, or the extension number

### VRS Messages

The VRS allows you to record up to 100 VRS messages. You allocate these messages for Automated Attendant greetings, the General Message, messages and the 900 Preamble message. The total storage time for all messages is approximately 400 minutes (four minutes x 100 files). The maximum duration for any message is four minutes – this is not programmable. VRS messages are stored on the system drive, and do not require battery back up.

Any on-premise extension caller can listen, record and erase VRS Messages (unless restricted in programming). DISA and DID callers can listen and record VRS messages (unless restricted in programming).

### General Message

A General Message is a recorded message available to all callers. A General Message typically contains important company information that all employees should hear. To hear the General Message, an employee can go to any multiline terminal and press 4 (for General Message). You can restrict the ability to record the General Message in an extension Class of Service. This allows you to give recording ability to the System Administrator or Communications Manager, for example, but not any other employee. The Message Waiting LED at each telephone flashes when a new General Message is recorded. After the extension user listens to the message, the Message Waiting LED goes out.

## Park and Page

When an extension user is away from their telephone, Park and Page can let them know when they have a call waiting to be answered. The Personal Greeting and Park & Page options can have up to 200 total messages (note that the Park & Page feature uses two messages). To enable Park and Page, the user records a Personal Greeting along with an additional Paging announcement. Park and Page then answers an incoming call and plays the Personal Greeting to the caller. The caller then listens to Music on Hold (if available) while the system broadcasts the recorded Paging announcement. When the extension user hears the Page, they can go to any telephone and use Directed Call Pickup to intercept the call. Refer to [Call Forwarding on page 2-153](#), [Paging, External on page 2-1257](#), [Paging, Internal on page 2-1267](#), and [Park on page 2-1272](#).

## Automated Attendant (Operator Assistance)

Automated Attendant automatically answers outside calls, plays a recorded greeting and then lets the outside callers directly dial system extensions, Department Calling Groups and Voice Mail. Automated Attendant provides immediate answering and routing of outside calls without the need for an operator or dispatcher. Automated Attendant provides:

### ❑ Single Digit Dialing

Single Digit Dialing allows Automated Attendant callers to dial extensions, Department Calling Groups, and Voice Mail by pressing a single digit. For example, your Automated Attendant can greet calls with, *“Thank you for calling. To place an order, dial 1. To check on an existing order, dial 2. To speak with an operator, dial 0.”* You can set up single digit dialing for each VRS Message programmed to answer outside calls via the Automated Attendant. This allows you to set up day/night/holiday greetings or unique greetings for each incoming trunk. (Keep in mind that, with a default system, if you assign destinations to digits 3, 4 and 5, outside callers cannot dial system extensions.)

Security of a communication system is the responsibility of the installer/maintainer and the network providers. However NEC will, of course, be pleased to offer advice on specific queries or issues brought to our attention.

The timer in Program 25-16-01, has been added, per single digit table, which enables the direct dialing of destinations even if a destination or another VRS message has been assigned to a digit. This timer, when set, defines a time that is required to expire after the first digit is dialed before the action assigned to the digit in the single digit table is used. If additional digits arrive before the timer expires, these and possible further digits are used as the direct dial destination.



NOTE

- *The timer (Program 25-16-01) works only when destination is set in Program 25-06-02. If Program 25-06-01 is used (other than 0), single digit attendant works.*
- *If the timer (Program 25-16-01) is set 0, this feature is deactivated. If the timer value is longer than inter-digit timer (Program 21-01-03), the setting of Program 25-16-01 has no effect.*

### ❑ Simultaneous Call Answering

With VRS installed, the Automated Attendant can answer up to 16 calls simultaneously.

**Flexible Routing**

The outside caller can directly dial any system extension, Department Calling Group or Voice Mail. If the caller dials a busy extension, Automated Attendant allows them to dial another extension or wait for the busy extension to become free.

 **Automatic Overflow**

Automatic Overflow can automatically redirect a call if it cannot go through. This can happen if all VRS ports are busy, if the called extension does not answer, or if the caller misdials or waits too long to dial. (This occurs if the caller is using a dial pulse telephone.) When the call overflows, it rings a designated Ring Group or the Voice Mail system.

 **Programmable Automated Attendant Greetings**

You can record a different greeting for each trunk answered by the Automated Attendant. The greetings can be different in the day, at night or on holidays or weekends. You can also have a special greeting if the caller misdials. You record the greetings just the way you want. For example, *“Dial the 3-digit extension number you wish to reach, dial 500 for Sales or dial 600 for Customer Service.”* When assigning and recording Automated Attendant greetings, you can choose among the 100 VRS messages.

## VRS Waiting Message

Using VRS Waiting Message, the system can automatically answer an incoming trunk call first (either a normal trunk or one designated for a department group) to let the outside caller hear a recorded message when the call is not answered in a programmed time. With this feature, the call keeps ringing at the same destination until it is answered or until other programming, takes affect.

This feature can use up to two messages for an incoming call and the duration between the messages is programmable. These messages are repeated and, between these messages, either ring back tone or Music on Hold can be played.

This feature has two different modes:

 **Permanent Mode**

This mode sets the feature using system programming and is available for the following calls:

 Normal Incoming Call

When the call is not answered or a user presses the VRS Waiting Message function key, this feature is initiated. The waiting message is played until other no-answer program (e.g. transfer to another incoming ring group or disconnect) takes affect.

 Designated Call for the Department Group

When a department group receives a call from a DID, DIL, DISA or E&M trunk and all terminals in the group are busy, the call is put in a queue and VRS Waiting Message is also initiated. The waiting message is played until other no-answer program (e.g. transfer to another incoming ring group or disconnect) takes affect or a terminal becomes available to receive the department call.

 **Manual Mode**

This mode can be programmed by pressing the VRS Waiting Message function key from a multiline terminal to set this feature for each incoming ring group. This mode can be used for normal incoming calls only.

The following programs are used to define the VRS Waiting Message feature and the trunk overflow:

- 11-10-20: Service Code Setup (for System Administrator) – VRS - Record/Erase Message
- 15-07: Programmable Function Keys  
Automatic Answer with Delay Message Setup (Function Number 52)



NOTE

*Function Key 52 can be used to enable the VRS Waiting Message feature when Program 22-01-10 is set to 1 (Changed by Manual Operation).*

Automatic Answer with Delay Message Start (Function Number 53)



NOTE

*Function Key 53 can be used to play the VRS Waiting Message immediately when Function Key 53 + the ringing Trunk Appearance Key are pressed.*

- 20-07-13: Class of Service Options (Administrator Level) – VRS Record (VRS Msg Operation)
- 20-15-11: Ring Cycle Setup – VRS Waiting Message Incoming Call
- 22-01-04: System Options for Incoming Calls – DIL No Answer Recall Time
- 22-01-08: System Options for Incoming Calls – DID Pilot Call No Answer Timer
- 22-01-10: System Options for Incoming Calls – VRS Waiting Message Operation
- 22-01-11: System Options for Incoming Calls – VRS Waiting Message Interval Time
- 22-08-01: DIL/IRG No Answer Destination
- 22-14-01~07: VRS Delayed Message for IRG
- 22-15-01~07: VRS Delayed Message for Department Group
- 25-07-02: System Timers for VRS/DISA – VRS/DISA No Answer Time
- 25-07-03: System Timers for VRS/DISA – Disconnect after VRS/DISA retransfer to IRG

## Transfer to the VRS

Any extension user can Transfer their outside call to the VRS. This lets their caller take advantage of the Automated Attendant's extensive routing abilities. To Transfer the call, the user places the call on Hold, dials the unique VRS service code (set up in system programming : default 782), and hangs up.

## Voice Prompting Messages

The VRS feature provides the system with Voice Prompting Messages. These Voice Prompting Messages tell the extension user the status or progress of their call. For example, if a user calls extension 300 when it is busy, they hear, "Station 300 is unavailable, please dial a new station or dial 750 to wait."

The following table shows the available Voice Prompting Messages.

*Table 2-162 Voice Prompting Messages*

Message No.	Message	This message will play when . . .
1-00	<b>This is station</b>	<b>A user dials 6 for the extension number.</b>
1-01	<b>Station</b>	<b>A user dials 6 for the extension number.</b>
1-02	<b>Is busy, for callback dial</b>	<b>A user is calling a busy extension.</b>
1-03	<b>All lines are busy, for callback dial</b>	<b>A user dials 9 or 704 (+ trunk group) and all trunks are busy.</b>
1-04	<b>Please do not disturb</b>	<b>A user calls an extension that has enabled Do Not Disturb.</b>
1-05	<b>Please hold on, all lines are busy, your call will be answered when a line becomes free.</b>	<b>message - refer to the UNIVERGE SV9100 Manual.</b>
1-06	<b>Please hold on, your call is being rerouted</b>	<b>Call Forwarding Off-Premise is rerouting your call.</b>
1-07	<b>The lowest cost line is busy, please wait for the next one.</b>	<b>ARS tries to reroute the user's call and the least costly route is busy.</b>
1-08	<b>The number you have dialed is not in service.</b>	<b>User dials a Service Code that Class of Service prevents.</b>
1-09	<b>You have a message.</b>	<b>An extension user has a Message Waiting to which they have not responded.</b>
1-10	<b>You have a message.</b>	<b>An extension user has a Message Waiting to which they have not responded.</b>
1-11	<b>Your calls have been forwarded.</b>	<b>An extension user has forwarded their calls.</b>
1-12	<b>Vacant number</b>	<b>An extension user has dialed an extension that does not exist.</b>
1-13	<b>Is unavailable</b>	<b>An outside caller dials an extension through the Automated Attendant and the extension is busy.</b>
1-14	<b>Please dial a new station</b>	
1-15	<b>Or dial</b>	
1-16	<b>To wait</b>	
1-17	<b>To leave your number</b>	
1-18	<b>Dial # to call you back at</b>	
1-19	<b>Enter your area code and telephone number</b>	<b>An outside caller dials an extension through the Automated Attendant and the extension is busy.</b>
1-20	<b>Please enter your password</b>	
1-21	<b>Please enter an account code</b>	<b>A user tries to place a trunk call and Forced Account Codes are enabled.</b>

Table 2-162 Voice Prompting Messages (Continued)

Message No.	Message	This message will play when . . .
1-22	<b>Please start recording</b>	A user has dialed the code to record a VRS message.
1-23	<b>Recording finished</b>	A user is recording a VRS message and they have exceeded the maximum allowed recording length.
1-24	<b>Audio file is full</b>	There is no more space available in the VRS for storing messages.
1-25	<b>To listen dial</b>	A user is trying to record a VRS message and the recording already exists.
1-26	<b>To erase dial</b>	
1-27	<b>To re-record dial</b>	
1-28	<b>To save dial</b>	
1-29	<b>To leave a message</b>	
1-30	<b>Just a moment</b>	
1-31	<b>Hello</b>	
1-32	<b>Thank you</b>	
1-33	<b>Good-bye</b>	
2-00	<b>Oh</b>	A user dials 6 for the extension number or 8 for the time.
2-01	<b>Dial</b>	
2-02	<b>Star</b>	
2-03	<b>Pound</b>	
2-04	<b>Zero</b>	
2-05	<b>One</b>	A user dials 6 for the extension number, 8 for the time and date or as part of a spoken code (e.g., 714).
2-06	<b>Two</b>	
2-07	<b>Three</b>	
2-08	<b>Four</b>	
2-09	<b>Five</b>	
2-10	<b>Six</b>	
2-11	<b>Seven</b>	
2-12	<b>Eight</b>	
2-13	<b>Nine</b>	
2-16	<b>Twelve</b>	
2-15	<b>Eleven</b>	



Table 2-162 Voice Prompting Messages (Continued)

Message No.	Message	This message will play when . . .
2-17	<b>Thirteen</b>	
2-18	<b>Fourteen</b>	
2-19	<b>Fifteen</b>	
2-20	<b>Sixteen</b>	
2-21	<b>Seventeen</b>	
2-22	<b>Eighteen</b>	
2-23	<b>Nineteen</b>	
2-24	<b>Twenty</b>	
2-25	<b>Thirty</b>	
2-26	<b>Forty</b>	
2-27	<b>Fifty</b>	
2-28	<b>Sixty</b>	
2-29	<b>Seventy</b>	
2-30	<b>Eighty</b>	
2-31	<b>Ninety</b>	
2-32	<b>Hundred</b>	
2-33	<b>Thousand</b>	
2-43	<b>Message</b>	
2-44	<b>Messages</b>	
2-64	<b>January</b>	
2-65	<b>February</b>	
2-66	<b>March</b>	
2-67	<b>April</b>	
2-68	<b>May</b>	
2-69	<b>June</b>	
2-70	<b>July</b>	
2-71	<b>August</b>	
2-72	<b>September</b>	
2-73	<b>October</b>	
2-74	<b>November</b>	
2-75	<b>December</b>	

Table 2-162 Voice Prompting Messages (Continued)

Message No.	Message	This message will play when . . .
2-76	<b>Sunday</b>	<b>A user dials 8 for the date.</b>
2-77	<b>Monday</b>	
2-78	<b>Tuesday</b>	
2-79	<b>Wednesday</b>	
2-80	<b>Thursday</b>	
2-81	<b>Friday</b>	
2-82	<b>Saturday</b>	
2-83	<b>The date is</b>	<b>A user dials 8 for the date.</b>
3-04	<b>The time is</b>	<b>A user dials 8 for the time.</b>
3-05	<b>AM</b>	
3-06	<b>PM</b>	

### 900 Preamble

If the system has trunks that are part of a 900 (caller paid) service, the VRS can automatically play a recorded message when a user answers the call. This recorded message should describe the 900 service features and cost. The 900 Preamble ensures that the caller is always aware that they have accessed a 900 pay-per-call service. A system user cannot converse with the caller until the preamble message ends. If the caller hangs up before the message completes, they are not charged for the call. If the caller waits for the message to end, they can talk to a system user and call charging begins. The system answers as many 900 calls as there are available VRS ports. If a 900 calls comes in when all VRS ports are busy, the call does not appear on an extension until a VRS port is available.

You can also use the 900 Preamble message to set up an *Auto-Answer with Greeting* application. When a receptionist answers a call, the VRS can play a preamble message such as, “Welcome to ABC Company. How can I help you?” When the caller replies, the receptionist answers, “One moment please,” and quickly extends the call to the desired party. This ensures that all incoming calls are answered quickly, courteously and consistently.

### Conditions

- VRS record time is fixed at four minutes and cannot be changed.
- The Automated Attendant (VRS) can answer up to 16 calls simultaneously.
- If Synchronous Ringing is enabled, the Preamble message cannot be used.
- The maximum number of VRS ports is 16 when the SV9100 is properly licensed.

- When the DISA/VRS Ring Group Transfer (Programs 25-03 and 25-04) is set to 104 (Speed Dial Bin), Speed dial will be treated as an internal call no matter what Program 13-01-01 is set to. If an outside number is needed, the trunk access code must be put into the speed dial bin.
- When Program 25-16-02, is set to 0 = Off (Do not detect DTMF), after playing a VRS greeting, the transfer destination set in Program 25-03-01 is followed.
- Program 25-03-01 is set on a per trunk port base, not Dial-in number base.
- A DISA Password can be detected regardless of Program 25-16-02 setting.
- If an outside caller dials an invalid extension number when connected to the VRS Automated Attendant or calling in on a DISA trunk, the following options are available to route these calls:
  - Extension Number (e.g., operator)
  - F-Route Dial (e.g., outside phone number)

### Default Settings

Disabled

## System Availability

### Terminals

None

### Required Component(s)

- 1001 – SV9100 InMail VRS Port Lic

## Related Features

➔ [Transfer](#)

## Guide to Feature Programming

The **Level 1**, **Level 2** and **Level 3** columns indicate the programs that are assigned when programming this feature in the order they are most commonly used. These levels are used with PCPro and WebPro wizards for feature programming.

- Level 1 – these are the most commonly assigned programs for this feature.
- Level 2 – these are the next most commonly assigned programs for this feature.
- Level 3 – these programs are not often assigned and require an expert level working knowledge of the system to be properly assigned.

Program Number	Program Name/Description	Input Data	Default	Level		
				1	2	3
11-10-20	<b>Service Code Setup (for System Administrator) – VRS - Record/Eraser Message</b> Define the service code to record or erase a VRS message.	MLT, SLT 0 ~ 9, *, # Maximum of eight digits	616		✓	
11-10-21	<b>Service Code Setup (for System Administrator) – VRS - General Message Playback</b> Define the service code to playback the general message.	MLT, SLT 0 ~ 9, *, # Maximum of eight digits	611		✓	
11-10-22	<b>Service Code Setup (for System Administrator) – VRS - Record or Erase General Message</b> Define the service code to record or erase a general message on the VRS.	MLT, SLT 0 ~ 9, *, # Maximum of eight digits	612		✓	
11-12-54	<b>Service Code Setup (for Service Access) – VRS Routing for ANI/DNIS</b> Define the service code to use when setting up ANI/DNIS Routing to the VRS Automated Attendant. Using the Transfer feature, this also allows a call to be transferred to the VRS (default: 782).	MLT, SLT 0 ~ 9, *, # Maximum of eight digits	782		✓	
15-07-01	<b>Programmable Function Keys</b> For the VRS Waiting Message feature, assign the VRS Incoming Call Queuing Setup key (code 52 + ring group #) to manually enable the feature.	Line Key 1 ~ 48 0 ~ 99 (Normal Function Code 751 by default) *00 ~ *99 (Appearance Function Code) (Service Code 752 by default)	Refer to the Programming Manual for default values.	✓		
20-06-01	<b>Class of Service for Extensions</b> Assign a Class of Service (1 ~ 15) to extensions.	Day Night/Mode: 1 ~ 8 Class of Service of Extensions (1 ~ 15)	Extension port 101 = Class 15 All other extension port = Class 1		✓	
20-07-13	<b>Class of Service Options (Administrator Level) – VRS Record (VRS Msg Operation)</b> Turn Off or On an extension user ability to record, listen to, or erase VRS messages.	0 = Off 1 = On	COS 1 ~ 14 = 0 COS 15 = 1	✓		

Program Number	Program Name/Description	Input Data	Default	Level		
				1	2	3
20-07-14	<b>Class of Service Options (Administrator Level) – VRS General Message Play</b> Turn Off or On an extension user ability to dial 4 or Service Code 611 to listen to the General Message.	0 = Off 1 = On	COS 1 ~ 14 = 0 COS 15 = 1	✓		
20-07-15	<b>Class of Service Options (Administrator Level) – VRS General Message Record/Delete</b> Turn Off or On an extension user ability to dial Service Code 612 and record, listen to, or erase the General Message.	0 = Off 1 = On	COS 1 ~ 14 = 0 COS 15 = 1	✓		
20-11-15	<b>Class of Service Options (Hold/Transfer Service) – VRS Personal Greeting (Message Greeting)</b> Turn Off or On an extension user ability to dial Service Code 616 to record, listen to, or erase a Personal Greeting. This option also affects Park and Page.	0 = Off 1 = On	COS 1 ~ 15 = 1		✓	
20-13-23	<b>Class of Service Options (Supplementary Service) – Display the Reason for Transfer</b> Select whether or not an extension should display the reason a call is being transferred to their extension (Call Forward Busy, Call Forward No Answer, DND).	0 = Off 1 = On	COS 1 ~ 15 = 0		✓	
20-15-11	<b>Ring Cycle Setup – VRS Waiting Message Incoming Call</b> Set the ring cycle callers hear when the VRS Waiting Message feature is used.	Ringing Cycle = 1 ~ 13	6			✓
21-01-02	<b>System Options for Outgoing Calls – Intercom Interdigit Time</b> When placing Intercom calls, users must dial each digit during this time.	0 ~ 64800 seconds	10		✓	
22-01-10	<b>System Options for Incoming Calls – VRS Waiting Message Operation</b> Define whether the VRS Waiting Message is Automatically or Manually set.	0 = Enable Always 1 = Change by Manual Operation	0		✓	
22-01-11	<b>System Options for Incoming Calls – VRS Waiting Message Interval Time</b> For VRS Waiting Message, determine the time between VRS messages.	0 ~ 64800 seconds	20		✓	

Program Number	Program Name/Description	Input Data	Default	Level		
				1	2	3
22-02-01	<b>Incoming Call Trunk Setup</b> For each Night Service mode, enter 1 if trunk should be automatically answered by VRS Automated Attendant.	Trunks 1 ~ 400 0 = Normal 1 = VRS (second dial tone if no VRS installed) 2 = DISA 3 = DID 4 = DIL 5 = E&M Tie line 6 = Delayed VRS 7 = ANI/DNIS 8 = DID(DDI) Mode Switching	0		✓	
22-04-01	<b>Incoming Extension Ring Group Assignment</b> Assign extensions (up to 48) to Ring Groups. Calls ring extensions according to Ring Group programming.	Maximum of eight digits.	Extensions 101 ~ 108 (first eight ports) ring for incoming Ring Group 1 calls. No other extensions ring for incoming Ring Group 1 calls.		✓	
22-14-01	<b>VRS Delayed Message for IRG – 1st Delayed Message Start Time</b> For each Ring Group, set the time the system waits before playing the first message. This time is also used for VRS Waiting Message.	0 ~ 64800 seconds	0	✓		
22-14-02	<b>VRS Delayed Message for IRG – 1st Delayed Message Number</b> For each Ring Group, select the message number to be played as the first message (0 ~ 101). This program is also used for VRS Waiting Message.	0 ~ 101 0 = No Message 101 = Fixed Message	0		✓	
22-14-03	<b>VRS Delayed Message for IRG – 1st Delayed Message Sending Count</b> For each Ring Group, set the number of times the first message is played. This program is also used for VRS Waiting Message.	0 ~ 255 (times)	0	✓		
22-14-04	<b>VRS Delayed Message for IRG – 2nd Delayed Message Number</b> For each Ring Group, select the message number to be played as the second message (0 ~ 101). This program is also used for VRS Waiting Message.	0 ~ 101 0 = No Message 101 = Fixed Message	0		✓	
22-14-05	<b>VRS Delayed Message for IRG – 2nd Delayed Message Sending Count</b> For each Ring Group, set the number of times the second message is played. This program is also used for VRS Waiting Message.	0 ~ 255 (times)	0	✓		

Program Number	Program Name/Description	Input Data	Default	Level		
				1	2	3
22-14-06	<b>VRS Delayed Message for IRG – Tone Kind at Message Interval</b> For each Ring Group, determine what the caller hears between messages. This program is also used for VRS Waiting Message.	0 = Ring Back Tone 1 = MOH Tone 2 = BGM Source	0	✓		
22-14-07	<b>VRS Delayed Message for IRG – Disconnect Time After the end of VRS Delayed Message</b> For each Ring Group, set the time the system waits after playing the VRS message before disconnecting the call. To prevent the call from disconnecting, set this option to 0. This program is also used for VRS Waiting Message.	0 = No Disconnect 1 ~ 64800 seconds	60		✓	
22-15-01	<b>VRS Delayed Message for Department Group – 1st Delayed Message Start Time</b> For each Department Group, set the time the system waits before playing the first message. This program is also used for VRS Waiting Message.	0 ~ 64800 seconds	0	✓		
22-15-02	<b>VRS Delayed Message for Department Group – 1st Delayed Message Number</b> For each Department Group, select the message number to be played as the first message (0 ~ 101). This program is also used for VRS Waiting Message.	0 ~ 101 0 = No Message 101 = Fixed Message	0	✓		
22-15-03	<b>VRS Delayed Message for Department Group – 1st Delayed Message Sending Count</b> For each Department Group, set the number of times the first message is played. This program is also used for VRS Waiting Message.	0 ~ 255 (times)	0	✓		
22-15-04	<b>VRS Delayed Message for Department Group – 2nd Delayed Message Number</b> For each Department Group, select the message number to be played as the second message (0 ~ 101). This program is also used for VRS Waiting Message.	0 ~ 101 0 = No Message 101 = Fixed Message	0	✓		
22-15-05	<b>VRS Delayed Message for Department Group – 2nd Delayed Message Sending Count</b> For each Department Group, set the number of times the second message is played. This program is also used for VRS Waiting Message.	0 ~ 255 (times)	0	✓		
22-15-06	<b>VRS Delayed Message for Department Group – Tone Kind at Message Interval</b> For each Department Group, determine what the caller hears between messages. This program is also used for VRS Waiting Message.	0 = Ring Back Tone 1 = MOH Tone 2 = BGM Source	0	✓		

Program Number	Program Name/Description	Input Data	Default	Level		
				1	2	3
22-15-07	<p><b>VRS Delayed Message for Department Group – Disconnect Time After the End of VRS Delayed Message</b></p> <p>For each Department Group, set the time the system waits after playing the VRS message before disconnecting the call. To prevent the call from disconnecting, set this option to 0. This program is also used for VRS Waiting Message.</p>	0 = No Disconnect 1 ~ 64800 seconds	60		✓	
24-02-03	<p><b>System Options for Transfer – Delayed Call Forwarding Time</b></p> <p>Set the time a telephone rings before the call reroutes to the programmed destination.</p>	0 ~ 64800 seconds	10		✓	
25-01-02	<p><b>VRS/DISA Line Basic Data Setup – DISA User ID</b></p> <p>Select whether or not the DISA User ID is to be used.</p>	0 = Off 1 = On	1		✓	
25-01-04	<p><b>VRS/DISA Line Basic Setup – VRS/DISA Transfer Tone</b></p> <p>Select VRS/DISA Transfer Tone as Inbound Tone sent to external caller while the VRS/ DISA call is transferred.</p>	0 = Ring Back Tone 1 = MOH	0		✓	
25-02-01	<p><b>DID/DISA VRS Message</b></p> <p>For each Night Service mode, enter 1 at the Talkie prompt if trunk should be automatically answered by VRS and the message number the caller should hear (1 ~ 101).</p>	0 = No Message 1 = VRS (01 ~ 100 VRS Message Number) 2 = ACI (01 ~ 04 ACI Group Number) 3 = Department Groups (01 ~ 64 Extension Group Number)	0	✓		
25-03-01	<p><b>VRS/DISA Transfer Ring Group With Incorrect Dialing</b></p> <p>Set the destination that Automated Attendant (OPA) calls ring if the OPA caller dials an incorrect extension number. This also sets the options for DISA calls. The system allows Ring Groups or Disconnect.</p>	Ring Groups: 1 ~ 100 Trunk Ports: 001 ~ 400 Day/Night Mode: 1 ~ 8 0 = Disconnect 1 ~ 100 = Incoming Ring Group 101 = DSPDB-VM 102 = In-Skin/External Voice Mail or InMail 104 = Speed Dial Bin (table Program 25-15-01)	0		✓	



Program Number	Program Name/Description	Input Data	Default	Level		
				1	2	3
25-04-01	<p><b>VRS/DISA Transfer Ring Group With No Answer/Busy</b></p> <p>Set the destination that Automated Attendant (OPA) calls ring if the OPA caller dials an extension that does not answer or is busy. This also sets the options for DISA calls. The system allows Ring Groups or Disconnect.</p>	<p>Ring Groups: 1 ~ 100</p> <p>Trunk Ports: 001 ~ 400</p> <p>Day/Night Mode: 1 ~ 8</p> <p>0 = (Disconnect)</p> <p>1 ~ 100 = (Incoming Ring Group)</p> <p>102 = (In-Skin/External Voice Mail or InMail)</p> <p>104 = (Speed Dial table Program 25-15-01).</p>	0		✓	
25-05-01	<p><b>VRS/DISA Error Message Assignment</b></p> <p>For each trunk answered by VRS, enter the VRS message (1 ~ 100) the outside caller hears if they dial incorrectly after answer. If you enter 0, the call reroutes according to Program 25-03 and Program 25-04. Make one entry for each Night Service mode.</p>	0 ~ 100 (0 = No Setting)	0		✓	
25-06-01	<p><b>VRS/DISA One-Digit Code Attendant Setup – Next Attendant Message Number</b></p> <p>Set up single digit dialing for Automated Attendant callers. For each VRS Message programmed to answer outside calls (see Program 25-02-01), specify the digit the Automated Attendant caller dials (1 ~ 9, 0, *, #). (Keep in mind that if you assign destinations to digits 3 and 4, outside callers cannot dial system extensions.)</p>	<p>0 ~ 100 (0 = No Setting)</p> <p>101 = Voice Mail Answers</p> <p>104 = Refer to 25-04: VRS/DISA Transfer Ring Group with No Answer/ Busy</p> <p>105 = Dial the other extension</p> <p>106 = Record VRS</p>	0		✓	
25-06-02	<p><b>VRS/DISA One-Digit Code Attendant Setup – Destination Number</b></p> <p>Set up single digit dialing for Automated Attendant callers. For each VRS Message programmed to answer outside calls (see Program 25-02-01), specify the destination reached (eight digits maximum) when the caller dials the single digit code.</p>	Maximum of eight digits.	No Setting		✓	
25-07-02	<p><b>System Timers for VRS/DISA – VRS/DISA No Answer Time</b></p> <p>If an Automated Attendant caller dials an extension that does not answer, the call waits this time before rerouting to the Ring Group specified in Program 25-03 and Program 25-04. This time also affects unanswered DISA calls.</p>	0 ~ 64800 seconds	0		✓	
25-07-03	<p><b>System Timers for VRS/DISA – Disconnect after VRS/DISA retransfer to IRG</b></p> <p>Set the time for disconnecting a call after it is re-transferred to a ring group by VRS/DISA.</p>	0 ~ 64800 seconds	60		✓	

Program Number	Program Name/Description	Input Data	Default	Level		
				1	2	3
25-08-01	<b>DISA User ID Setup – Password</b> Set up password (six digits).	Dial (Six digits fixed) (0 ~ 9, *, #)	No Setting		✓	
25-13-01	<b>System Option for DISA – VRS Message Access Password</b> Enter the password DISA callers must dial before the system allows them to record, listen to or erase VRS messages.	Six digits fixed (0 ~ 9, *, #)	No Setting		✓	
25-15-01	<b>DISA Transfer Target Setup – DISA Transfer Target Area at Wrong Dial</b> Used to assign a speed dial number when the wrong number is received.	Speed Dial bin number 0 ~ 1999	1999	✓		
25-15-02	<b>DISA Transfer Target Setup – DISA Transfer Target Area at No Answer or Busy</b> Used to assign a speed dial number when a dial tone times-out and the target extension does not answer or is busy.	Speed Dial bin number 0 ~ 1999	1999	✓		
25-16-01	<b>DID/DISA Talkie Base Setup – Single Digit Timer</b> Assign a timer, per single digit table, required to expire before the allocated single digit entry is applied.	0 ~ 64800 (0 = No Setting)	0		✓	
25-16-02	<b>DID/DISA Talkie Base Setup – DTMF Detect</b> <b>1 = On</b> setting detects DTMF signal during sending VRS message for DID/DISA call. <b>0 = Off</b> setting does not detect DTMF signal during sending VRS message for DID/DISA call.	0 = Off 1 = On	1		✓	
25-17-01	<b>VRS/DISA Attendant Message Service Setup – Transfer Ring Group at Wrong Dialing</b> Set the transfer destination for VRS, DID, DISA and DID mode switching Trunk. The destination can be a Ring Group, Voice Mail or Speed dial.	Attendant Message Number (1~100) 0 = Refer PRG 25-03 1 ~ 100 = Incoming Ring Group 102 = In-Skin/External Voice Mail or InMail 104 = Speed Dial Bin (Program 25-17-03)	0	✓		
25-17-02	<b>VRS/DISA Attendant Message Service Setup – Transfer Ring Group at No Answer/Busy</b> Set the transfer destination for VRS, DID, DISA and DID mode switching Trunk. The destination can be a Ring Group or Voice Mail and Speed dial.	Attendant Message Number (1~100) 0 = Refer PRG 25-04 1 ~ 100 = Incoming Ring Group 102 = In-Skin/External Voice Mail or InMail 104 = Speed Dial Bin (Program 25-17-04)	0	✓		
25-17-03	<b>VRS/DISA Attendant Message Service Setup – Transfer Target Area at Wrong Dialing</b> Assign a speed dial bin target number for wrong dialing/Dial tone timeout.	0 ~ 9999	9999	✓		

Program Number	Program Name/Description	Input Data	Default	Level		
				1	2	3
25-17-04	<b>VRS/DISA Attendant Message Service Setup – Transfer Target Area at No Answer or Busy</b> Assign a speed dial bin target number for the target extension no answer or busy.	0 ~ 9999	9999	✓		
25-18-01	<b>VRS/DISA Attendant Message Timer Setup – Dial Tone</b> After answering a VRS/DISA trunk, the system waits this time for the caller to dial the first digit.	0 ~ 64800	10	✓		
25-18-02	<b>VRS/DISA Attendant Message Timer Setup – No Answer Time</b> A VRS/DISA caller can ring an extension for this time before the system sets the call as a Ring No Answer.	0 ~ 64800	0	✓		
25-18-03	<b>VRS/DISA Attendant Message Timer Setup – Disconnect After VRS/DISA Retransfer to IRG</b> From VRS/DISA trunk, when the call may go to Incoming Ring Group (IRG) or speed dial of Program 25-17-02. This setting determines the time the call is ringing in the IRG or speed dial.	0 ~ 64800	60	✓		
31-02-01	<b>Internal Paging Group Assignment – Internal Paging Group Number</b> Assign extensions to Internal Paging Groups (i.e., Page Zones).	0 ~ 64 (0 = No Setting)	0 for IP Station 1 for TDM Station		✓	
31-02-02	<b>Internal Paging Group Assignment – Internal All Call Paging Receiving</b> Allow/Prevent All Call Internal Paging for each extension. If allowed, extension can place and receive All Call Internal Paging announcements. If prevented, extensions can make only (not receive) All Call Internal Paging announcements. If combined, Paging zones should be restricted as well. Change the internal page zone group in Program 31-07-01 to 0.	0 = Off 1 = On	0		✓	

Program Number	Program Name/Description	Input Data	Default	Level			
				1	2	3	
31-04-01	<p><b>External Paging Zone Group – Paging Group Number</b></p> <p>Assign each External Paging zone to an External Paging group.</p>	0 ~ 8 (0 = No Setting)	<p>Speaker 1 [PGD(2)-U10] = 1 (Group 1)</p> <p>Speaker 2 [PGD(2)-U10] = 2 (Group 2)</p> <p>Speaker 3 [PGD(2)-U10] = 3 (Group 3)</p> <p>Speaker 4 [PGD(2)-U10] = 4 (Group 4)</p> <p>Speaker 5 [PGD(2)-U10] = 5 (Group 5)</p> <p>Speaker 6 [PGD(2)-U10] = 6 (Group 6)</p> <p>Speaker 7 [PGD(2)-U10] = 7 (Group 7)</p> <p>Speaker 8 [PGD(2)-U10] = 8 (Group 8)</p> <p>Speaker 9 (GCD-CP10) = 1 (Group 1)</p>			✓	
31-07-01	<p><b>Combined Paging Assignments</b></p> <p>Assign an External Paging Group (0 ~ 8) to an Internal Paging Zone for Combined Paging. When an extension user makes a Combined Page, they simultaneously broadcast into both the External and Internal Zone.</p>	0 ~ 64 (0 = All internal paging)	1		✓		

Program Number	Program Name/Description	Input Data	Default	Level		
				1	2	3
40-07-01	<p><b>Voice Prompt Language Assignment for VRS</b></p> <p>Select the language to be used for the VRS. Although the system allows this option to be changed in programming, the language changes only if the SD card has the firmware which provides the newly selected language.</p>	1 = US English 2 = UK English 3 = AU English 4 = CA French 5 = Dutch 6 = Mex Spanish 7 = LA Spanish 8 = Italian 9 = German 10 = ES Spanish 11 = Norwegian 12 = ParisFrench 13 = BR Portugue 14 = Japanese 15 = MandChinese 16 = Korean 17 = IB Portugue 18 = Greek 19 = Danish 20 = Swedish 21 = Thai 22 = Taiwan 23 = Flemish 24 = Turkish 25 = Reserved 26 = Russian	1		✓	
40-10-01	<p><b>Voice Announcement Service Option – VRS Fixed Message</b></p> <p>Enable/Disable the system ability to play the fixed VRS messages (such as “You have a message.”).</p>	0 = Not Used 1 = Used	0	✓		
40-10-02	<p><b>Voice Announcement Service Option – General Message Number</b></p> <p>Enter the number of the VRS message you want to use for the General Message (01~100). The message you select should not be used as a VRS message.</p>	0 ~ 100 (0=No General Message Service)	0		✓	
40-10-03	<p><b>Voice Announcement Service Option – VRS No Answer Destination</b></p> <p>Assign the transferred Ring Group when the VRS is unanswered after Call Forwarding with Personal Greeting Message.</p>	0 ~ 100 (Incoming Ring Group Number)	0 (No Setting)		✓	
40-10-04	<p><b>Voice Announcement Service Option – VRS No Answer Time</b></p> <p>If an extension has Personal Greeting enabled and all VRS ports are busy, a DIL or DISA call to the extension waits this time for a VRS port to become free.</p>	0 ~ 64800 seconds	0		✓	

Program Number	Program Name/Description	Input Data	Default	Level		
				1	2	3
40-10-05	<b>Voice Announcement Service Option – Park and Page Repeat Timer (VRS Msg Resend)</b> If a Park and Page is not picked up during this time, the Paging announcement repeats.	0 ~ 64800 seconds	0		✓	
40-10-06	<b>Voice Announcement Service Option – Set VRS Message for Private Call Refuse (VRS Msg Private Call)</b> Assign the VRS Message number used as Private Call Refuse. When Fixed message is set, VRS message guidance is: Service finished. Disconnect the line, please.	0 ~ 101 (0 = No message) (101 = Fixed message)	0		✓	
40-10-07	<b>Voice Announcement Service Option – Set VRS Message for Caller ID Refuse (VRS Msg CID)</b> Assign the VRS Message number used as Caller ID Refuse. When Fixed Message is set, VRS message guidance is: Service finished. Disconnect the line, please.	0 ~ 101 (0 = No message) (101 = Fixed message)	0		✓	
40-11-01	<b>Preamble Message Assignment</b> Assign the VRS Message number used as the Preamble Message for each trunk. When the extension user answers the incoming call, the assigned VRS message is sent to the outside caller.	0 ~ 100 (0 = No Service)	0			✓
47-03-02	<b>SV9100 InMail Group Mailbox Options – Mailbox Number</b> The Group Mailbox Number is the same as the Department Group master (pilot) number. Select the Department Group master (pilot) number associated with the Master Mailbox you are programming.	Digits (eight maximum, using 0 ~ 9) No Setting (entered by pressing <b>Hold</b> )	No Setting		✓	

## Operation

### VRS Messages

**To record a VRS message:**

1. Press **Speaker** or lift the handset.  
- OR -  
At a single line telephone, lift the handset.
2. Dial **616**.
3. Dial **7 (Record)**.
4. Dial the VRS message number you want to record (01~100).

5. When you hear, "Please start recording" followed by a beep, record your message.
6. Press # to end recording.  
- OR -  
Hang up to save the message.

**To listen to a previously recorded VRS message:**

1. Press **Speaker** or lift the handset.  
- OR -  
At a single line telephone, lift the handset.
2. Dial **616**.
3. Dial **5** (Listen).
4. Dial the VRS message number to which you want to listen (01~100).  
◇ *You hear the previously recorded message. If you hear a beep instead, no previous message is recorded.*
5. Press # to hear the message again.  
- OR -  
To hear another message, dial 5 and then enter the message number (01~100).  
- OR -  
Hang up.

**To erase a previously recorded VRS message:**

1. Press **Speaker** or lift the handset.  
- OR -  
At a single line telephone, lift the handset.
2. Dial **616**.
3. Dial **3** (Erase).
4. Dial the number of the VRS message you want to erase (01~100).
5. Press **Hold** (multiline terminal only) to cancel the procedure without erasing (and return to step 3).  
- OR -  
Hang up to erase the message.

**To record, listen to or erase a VRS message if you call in using DISA:**

1. Place call to the system.
  - ◇ *You hear dial tone.*
2. After the system answers, dial the DISA password (normally 000000).
  - ◇ *You hear dial tone.*
3. Dial **616** and the VRS password.
4. Dial the function you want.
  - 7 = Record**
  - 5 = Listen**
  - 3 = Erase**
5. Dial the message number (01~100), record the message and press **#** to end recording.
  - ◇ *If you dialed 7 to record, you can dial **#** to listen to the message you just recorded.*
  - ◇ *If you dialed 5 to listen, you can dial 5 and the message number to hear it again or if you want to Record, listen to or erase another message, go back to step 4.*

**General Message****To listen to the General Message:**Multiline Terminal Only

*Your Message Waiting LED flashes when there is a new General Message. A voice message periodically reminds you.*

1. Do not lift the handset or press **Speaker**.
2. Dial **4 (General)**.
  - OR -
1. Lift the handset and dial **611**.
  - ◇ *You hear the General Message.*
  - ◇ *Normally, your MW LED goes out. If it continues to flash, you have unanswered Message Waiting requests or new messages in your Voice Mail mailbox.*

**To record, listen to or erase the General Message:**

1. Press **Speaker** or lift the handset.
  - OR -At single line telephone, lift the handset.
2. Dial **612**.



3. Dial the function you want.

**7 = Record**

**5 = Listen**

**3 = Erase**

◇ *If you dialed 7 to record, press # to end the recording.*

◇ *If you dialed 5 to listen, you can dial 5 to listen to the message again.*

◇ *To Record the General Message again, go back to step 1.*

◇ *If you dialed 3 to erase the General Message, you must go to step 4 (hang up). To cancel without erasing on a multiline terminal, press HOLD instead and go back to step 1.*

4. Hang up when you are done.

### 900 Preamble

#### To answer a 900 Preamble call:

1. Answer the ringing call.

◇ *The line key or Call Appearance (CAP) key turns solid red as the system plays the preamble to the caller.*

2. When you hear two beeps and the line key turns green, converse with the caller.

## Voice Response System (VRS) Upload Download Audio

### Description

The Voice Response System (VRS) Upload Download Audio feature allows the upload of VRS greetings up to 1MB in size, recorded on a PC or professionally, to any valid VRS message in the system. It also allows users to listen to and delete VRS messages from callers. Access to the InMail/VRS drive is via the HTML User Pro (Web Pro).

The User Admin (UA Mode) can change Routing Mailbox greetings for the following Routing mailbox types: Instruction (Call Routing), Announcement and Group.

### Audio Prompt Format

In order for uploaded greetings to properly play on the VRS InMail CF they must be in the proper format. Audio files not recorded in the proper format may not playback on the VRS/InMail CF. The proper format is:

Bit Rate	64kbps
Sampling Size	8 bits
Channel	1 (Mono)
Sampling Rate	8 KHz
Audio Format	CCiTT u-law

### User Pro Access

There are two different User Pro logins available to make changes to audio files on the InMail/VRS CF, but only one allows changes to be made to VRS messages. To login, open an Internet browser and enter the IP of the SV9100 LAN port in the address line. At default, the IP address is 192.168.0.10.

**User Admin Mode (UA Mode):** This mode allows the user admin to access any telephone and mailbox in the system. This mode must be used to change VRS and Routing Mailbox greetings. At default the login ID is USER1 and the password is 1111.

**User Mode (UB Mode):** This mode allows a user to access only their own telephone and mailbox when logged in. They will not be able to change any other telephone, mailbox, VRS or Routing Mailbox. At default the login ID is the "Extension Number" and the password is 1111.

The following details the page layout diagram of the two different User Pro login IDs:

Figure 2-116 VRS User Pro Login Diagram

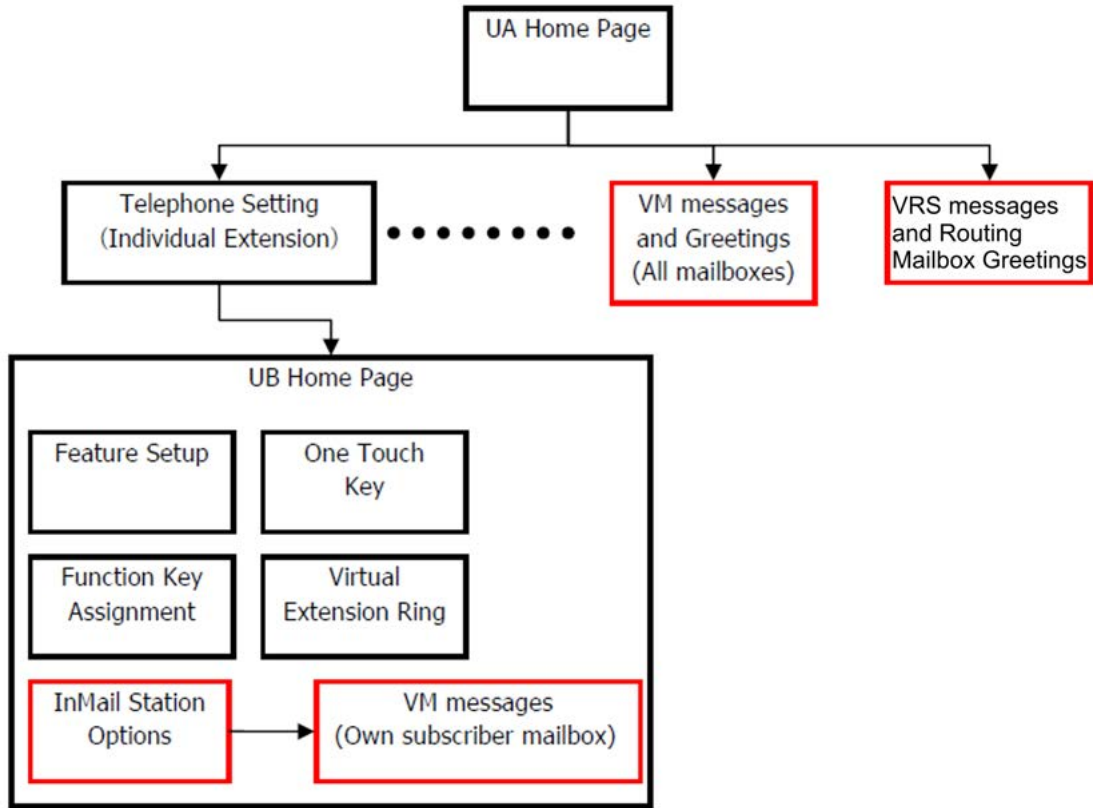

### Message Name Format

Downloaded messages are automatically assigned a name by the SV9100. This name includes the mailbox number the message was left in, type of message, the message number and the date and time to the second the message was left. [Table 2-163 Default Incoming Ringing Tone](#) shows how to interpret the message name to determine this information.

Table 2-163 Default Incoming Ringing Tone

File Name Format	BTNNN_YYYYMMDD_HHMMSS.wav (maximum 32 characters)
B	Mailbox number (maximum eight digits) or VRS for the VRS message
T	Message Type + : Greeting or VRS message - : Recorded message
NNN	Message number (three digits)

Table 2-163 Default Incoming Ringing Tone (Continued)

File Name Format	BTNNN_YYYYMMDD_HHMMSS.wav (maximum 32 characters)
YYYY	<b>Year</b>
MM	<b>Month (1~12)</b>
DD	<b>Date (1~31)</b>
HH	<b>Hour (00~23)</b>
MM	<b>Minute (00~59)</b>
SS	<b>Second (00~59)</b>

## Conditions

- Uploading audio files to any type of Call Routing box and Group mailboxes is supported. Auto attendant and group mailbox greetings can be uploaded or deleted using End User WebPro interface with the UA login.
- VRS and InMail messages are recorded in an ADPCM format which may not be easily opened on the support PC.
- It is not possible to upload/download/delete multiple files simultaneously.
- The mailbox will be inaccessible from the telephone under these conditions:
  - ❑ Mailbox XXX will not be accessible when opening the telephone setup screen of extension XXX by UA or UB mode in User Pro.
  - ❑ Mailbox XXX will not be accessible when selecting the extension XXX on the file upload/download screen of UA mode User Pro.
  - ❑ Mailbox XXX will be inaccessible when logging in the UB mode User Pro for extension XXX.
- While uploading an audio file via User Pro the greeting is not accessible by telephone.
- When downloading/deleting an audio file via User Pro, the file is not accessible by another User Pro session or from the telephone.
- This feature is only supported using a LAN connection.
- When uploading an audio file the extension will be checked whether it is WAV or not. However, the format of the uploaded file will not be checked. If the uploaded file is not in the proper format it may not playback properly.
- When a mailbox has a new message and the message is deleted using the User Pro interface, the MWI of the mailbox will NOT be cancelled.
- The largest allowed upload file size is approximately 1MB. Files larger than this cannot be uploaded.
- There is no size limitation when downloading audio files.

- User Pro does not check the uploaded file for correct naming format (i.e., BTNNN\_YYYYMMDD\_HHMMSS.wav). The file name will be automatically changed when the file is written in the CF.
- The actual file name of the messages is not displayed in User Pro. The message number, modified date and file size are displayed instead. If there is no message file, “-” will be displayed and the download/delete icon will not be displayed.
- The User Pro message page does not refresh automatically, to see new messages the page must be refreshed. For instance, if a new message is received via regular operation on the system while a user is viewing the upload/download screen, the new message is not shown until the page is reloaded by clicking the  icon.
- At default, Microsoft Windows will automatically open and play the downloaded WAV. To make **Open** or **Save** selectable, the following settings are required:
  - Windows XP
    1. Select **Control Panel** then **Folder Options**.
    2. Click on the **Files** tab.
    3. Select the **WAV** extension from the list, then click **Advanced**.
    4. Check **Confirm to open the file after download**, then click **OK**.
    5. Close the folder option by clicking **OK** again.
  - Windows Vista: It is not possible to change the save to folder option. The downloaded file is automatically opened for playback.
- With Version 4000 or higher software, UserPro displays the play time of the VRS audio file.

## Default Settings

None

## System Availability

### Terminals

All Terminals

### Required Component(s)

- 0411 – SV9100 Version Lic (R1)
- 0300 – SV9100 Resource Lic
- 1001 – SV9100 InMail VRS Port Lic

## Related Features

### ↳ Voice Response System (VRS)

## Guide to Feature Programming

The **Level 1**, **Level 2** and **Level 3** columns indicate the programs that are assigned when programming this feature in the order they are most commonly used. These levels are used with PCPro and WebPro wizards for feature programming.

- Level 1 – these are the most commonly assigned programs for this feature.
- Level 2 – these are the next most commonly assigned programs for this feature.
- Level 3 – these programs are not often assigned and require an expert level working knowledge of the system to be properly assigned.

Program Number	Program Name/Description	Input Data	Default	Level		
				1	2	3
90-02-01	<b>Programming Password Setup – User Name</b> Set the system passwords.	Maximum of 10 characters.	Refer to the Programming Manual for default values.		✓	
90-02-02	<b>Programming Password Setup – Password</b> Configure the administrator accounts that are used when connecting to the KTS via PCPro/ WebPro. If using PCPro, these are the accounts that are used to <i>connect</i> . If using WebPro, these are the accounts that are used to login.	Maximum of eight digits.	Refer to the Programming Manual for default values.		✓	
90-02-03	<b>Programming Password Setup – User Level</b> Set the system password user levels.	0 = Prohibited User 1 = MF (Manufacturer Level) 2 = IN (Installer Level) 3 = SA (System Administrator Level 1) 4 = SB (System Administrator Level 2) 5 = UA (User Programming Level 1)	Refer to the Programming Manual for default values.		✓	

## Troubleshooting

The table below shows possible Error messages and Causes:

Table 2-164 Error Messages and Causes

Error Message	Cause
Mailbox XXX does not exist. (XXX = mailbox number)	The mailbox does not exist
The mailbox is being used by another session	When the mailbox is being used by another session, either PC or telephone.
There is no available space in the SD.	When there is no available space in the SD.
The file is being used by another session. Please try again later.	When the file to be downloaded is being used by another session, either PC or telephone.
The selected file has already been deleted.	When the file selected for download has already been deleted.
The file is being used by another session. Please try again later.	When the file selected for deletion is being used by another session.
The selected file has already been deleted.	When the file selected for deletion has already been deleted.
Cannot upload the file since the original file is being used by another session. Please try again later.	When the file to be replaced is being used when trying to upload the replacement.

## Operation

### Changing VRS Messages using User Admin Mode (UA)

Audio files up to 1MB may be uploaded to the SV9100 for VRS messages. All 100 VRS messages can be uploaded or deleted. The messages can be used on all VRS features: General Message, Automated Attendant greetings, messages and the 900 Preamble.

In order for uploaded messages to play they must be in the proper format. Audio files not recorded in the proper format may not playback. The proper format is:

Bit Rate	64kbps
Sampling Size	8 bits
Channel	1 (Mono)
Sampling Rate	8 KHz
Audio Format	CCiTT u-law

- To login, open an Internet browser and enter the IP of the SV9100 LAN port in the address line. At default, the IP address is 192.168.0.10.
- At the login screen enter username = USER1 and password = 1111.
- You will then see the main menu, click on the VRS Audio Up/Download icon.

- 4. There can be up to 100 VRS messages and you may need to scroll through several pages or jump to get to the desired message number.
  - ◇ *The message numbers correspond to the same message number when accessed via the telephone. Message 1 is 001, message 2 is 002 and message 3 is 003, etc.*
- 5. To delete a message, click on the red X to the right of the appropriate message.
- 6. To Upload a message:
  - Under Message No, enter the message number to be replaced.
  - Browse to find the location where the greeting file is stored.
  - Click on the upload icon to the right of the selected file name.
  - Depending on file size and LAN speed, it may take a minute to upload the greeting.
  - The uploaded message will appear in the assigned location.



## Voice Response System (VRS) – Call Forwarding – Park and Page

### Description

When an extension user is away from their phone, VRS Park and Page can let them know when they have a call waiting to be answered. The Personal Greeting and Park & Page options can have up to 200 messages total (note that the Park & Page feature uses two messages). To enable VRS Park and Page, the user records a Personal Greeting along with an additional Paging announcement. VRS Park and Page then answers an incoming call and plays the Personal Greeting to the caller. The caller then listens to Music on Hold (if available) while the system broadcasts the recorded Paging announcement. When the extension user hears the Page, they can go to any telephone and use Directed Call Pickup to intercept the call.

For example, John Smith could record a Personal Greeting that says:

“Hello, this is John Smith. I am away from my phone right now but please hold on while I am automatically paged.”

The recorded Paging announcement could say:

“John Smith, you have a call waiting on your line.”

The incoming caller hears the first message and listens to Music on Hold while the system broadcasts the second message. John Smith could then walk to any phone and pick up his call. If John doesn't pick up the call, the Page periodically repeats.

VRS Park and Page follows the rules for Personal Greeting for All Calls, immediately rerouted. This means that Park and Page activates for ringing Intercom calls, DID calls and DISA calls. It also activates for calls transferred from the Automated Attendant. Additionally, calls from the Automated Attendant follow Automatic Overflow routing if not picked up. Park and Page activates for transferred outside calls but does not play the Personal Greeting to the caller. If a call comes in when the specified Page zone is busy, the system broadcasts the announcement when the zone becomes free.

### Conditions

- VRS Park and Page announcements only repeat once.
- Voice Announcement (VAU) recording time is fixed at two minutes and cannot be changed.
- While VRS Park and Page is enabled, only one DID call at a time can be processed. Subsequent callers hear a busy tone.

### Default Settings

- VRS Park and Page is available at default for internal paging access code 701, zone 1.
- Use access code 713. See feature Operation. Set Program 40-10-01 for VRS guidance message.

## System Availability

### Terminals

None

### Required Component(s)

- 0411 – SV9100 Version Lic (R1)
- 0300 – SV9100 Resource Lic
- 1001 – SV9100 InMail VRS Port Lic

## Related Features

- ➔ **Analog Communications Interface (ACI)**
- ➔ **Music on Hold**

## Guide to Feature Programming

The **Level 1**, **Level 2** and **Level 3** columns indicate the programs that are assigned when programming this feature in the order they are most commonly used. These levels are used with PCPro and WebPro wizards for feature programming.

- Level 1 – these are the most commonly assigned programs for this feature.
- Level 2 – these are the next most commonly assigned programs for this feature.
- Level 3 – these programs are not often assigned and require an expert level working knowledge of the system to be properly assigned.

Program Number	Program Name/Description	Input Data	Default	Level		
				1	2	3
11-11-58	<b>Service Code Setup (for Setup/Entry Operation) – Call Forward with Personal Greeting</b> Call forward with Personal greeting VRS. Service code setup.	MLT, SLT 0 ~ 9, *, # Maximum of eight digits	713		✓	
11-12-19	<b>Service Code Setup (for Service Access) – Internal Group Paging</b> Service code setup.	MLT, SLT 0 ~ 9, *, # Maximum of eight digits	701		✓	

Program Number	Program Name/Description	Input Data	Default	Level		
				1	2	3
11-12-20	<b>Service Code Setup (for Service Access) – External Paging</b> External paging access code. Service code setup.	MLT, SLT 0 ~ 9, *, # Maximum of eight digits	703		✓	
11-12-24	<b>Service Code Setup (for Service Access) – Combined Paging</b> Combined paging, internal/external access code. Service code setup.	MLT, SLT 0 ~ 9, *, # Maximum of eight digits	*1		✓	
20-06-01	<b>Class of Service for Extensions</b> Assign a Class of Service (1 ~ 15) to extensions.	Day Night/Mode: 1 ~ 8 Class of Service of Extensions (1 ~ 15)	Extension port 101 = Class 15 All other extension port = Class 1	✓		
31-02-01	<b>Internal Paging Group Assignment – Internal Paging Group Number</b> Assign extensions to Internal Paging Groups (i.e., Page Zones). The system allows up to 64 Internal Paging Groups. An extension can be in only one Internal Paging Group.	0 ~ 64 (0 = No Setting)	0 for IP Station 1 for TDM Station	✓		
31-03-01	<b>Internal Paging Group Settings – Internal Paging Group Name</b> Assign name to Internal Paging Groups (i.e., Page Zones). The system shows the name you program on the telephone displays.	Maximum of 12 characters.	Refer to the Programming Manual for default values.	✓		
31-04-01	<b>External Paging Zone Group – Paging Group Number</b> Assign each External Paging Speaker to an External Paging Zone.	0 ~ 8 (0 = No Setting)	Speaker 1 [PGD(2)-U10] = 1 (Group 1) Speaker 2 [PGD(2)-U10] = 2 (Group 2) Speaker 3 [PGD(2)-U10] = 3 (Group 3) Speaker 4 [PGD(2)-U10] = 4 (Group 4) Speaker 5 [PGD(2)-U10] = 5 (Group 5) Speaker 6 [PGD(2)-U10] = 6 (Group 6) Speaker 7 [PGD(2)-U10] = 7 (Group 7) Speaker 8 [PGD(2)-U10] = 8 (Group 8) Speaker 9 (GCD-CP10) = 1 (Group 1)	✓		

Program Number	Program Name/Description	Input Data	Default	Level		
				1	2	3
31-06-01	<b>External Speaker Control – Broadcast Splash Tone Before Paging (Paging Start Tone)</b> Enable/Disable splash tone before Paging over an external zone. If enabled, the system broadcasts a splash tone before the External Paging announcement.	0 = No Tone (None) 1 = Splash Tone 2 = Chime Tone	2	✓		
31-06-02	<b>External Speaker Control – Broadcast Splash Tone After Paging (Paging End Time)</b> Enable/Disable splash tone after Paging over an external zone. If enabled, the system broadcasts a splash tone at the end of an External Paging announcement.	0 = No Tone (None) 1 = Splash Tone 2 = Chime Tone	2	✓		
40-10-01	<b>Voice Announcement Service Option – VRS Fixed Message</b> Enable/Disable the system ability to play the fixed VRS messages (such as, You have a message).	0= Not Used 1= Used	0	✓		
40-10-05	<b>Voice Announcement Service Option – Park and Page Repeat Timer (VRS Msg Resend)</b> If a Park and Page is not picked up in this time, the Paging announcement repeats.	0 ~ 64800 seconds	0	✓		

## Operation

### To have the system page you when you have a call:

1. Press **Speaker** (or lift the handset at the single line telephone) and dial **713**.
2. When you hear, "Please start recording," record your Personal Greeting.
  - ◇ *If you already have Park and Page or Personal Greeting set up, you can dial:*
    - 3 to erase (the optionally HOLD to cancel the erase)*
    - 5 to listen (then # again to listen again)*
    - 7 to record again*
3. Dial **#7**.
4. When you hear, "Please start recording," record your page and dial **#** when the announcement is complete.
  - ◇ *A paging chime overrides the first four seconds of an announcement. Allow a delay in announcement recording for chime time.*
5. Dial the Page Zone that should broadcast your announcement.
  - For example, for Internal Zone 1 dial 701 + 1, or for Combined Paging Zone, 1 dial \*1 + 1.*
6. Dial the Park and Page type:
  - 2 = All Calls**

**3** = Outside Calls Only

7. Press **Speaker** to hang up (or go on-hook at the single line telephone).

#### To pick up your Park and Page:

1. Press **Speaker** (or lift the handset at the single line telephone).
2. Dial **\*\*** + your extension number.

#### To cancel your Park and Page:

1. Press **Speaker** (or lift the handset at the single line telephone).
2. Dial **713 + 3**.
3. Press **Speaker** to hang up (or go on-hook at the single line telephone).

## Volume Controls

### Description

Each multiline terminal user can control the volume of incoming ringing, splash tone, Paging, Background Music, Handsfree and your handset. Multiline terminals consolidate all adjustments into the volume buttons. Press the VOLUME ▲ or VOLUME ▼ to adjust the volume level for whichever feature is active (outside call, ICM, ICM ringing, paging, etc.). Press these keys when the telephone is idle to adjust the contrast level of the telephone display. The users should set the volumes for their most comfortable levels.

### Conditions

- The contrast is not adjustable when the telephone has background music enabled.
- Multiline terminal users can press the Speaker key and dial Code 729 to further increase station ring volume.
- Headset volume, off-hook ringing volume, station ringing volume, and speaker volume adjustments are determined by Program 15-02-27.
- The LCD of the SV9100 terminals provide a volume bar indication while adjusting the following volumes or controls:
  - Speaker Volume
  - Handset/Headset Volume
  - Background Music (BGM) Volume
  - Ring Volume/Off-Hook Ring Volume
  - LCD Contrast
- With the SV9100, the handset/speaker volume for intercom calls or outside calls can be adjusted.

### Default Settings

Enabled

### System Availability

#### Terminals

All Multiline Terminals

Required Component(s)

None

Related Features

- ↳ [Off-Hook Signaling](#)
- ↳ [SV9100 Terminals](#)

Guide to Feature Programming

The **Level 1**, **Level 2** and **Level 3** columns indicate the programs that are assigned when programming this feature in the order they are most commonly used. These levels are used with PCPro and WebPro wizards for feature programming.

- Level 1 – these are the most commonly assigned programs for this feature.
- Level 2 – these are the next most commonly assigned programs for this feature.
- Level 3 – these programs are not often assigned and require an expert level working knowledge of the system to be properly assigned.

Program Number	Program Name	Description/Comments	Assigned Data	Level		
				1	2	3
15-02-27	<b>Multiline Telephone Basic Data Setup – Handset Volume</b> Determine how an extension handset volume is set after it is adjusted during a call. When 1 is assigned, and a user sets the volume to maximum, it is reset to a level to meet FCC standards when the user hangs up.	0 = Back to Default (Back) 1 = Stay at previous level (Stay)	1		✓	

Operation

To adjust the volume of incoming ringing and splash tone:

1. If the telephone is idle, press **Speaker** and dial **729**. If the telephone is ringing, skip to Step 2.
2. Press VOLUME ▲ or VOLUME ▼.

**To adjust the volume of ringing incoming Paging announcements, Handsfree, the handset or Background Music:**

1. Press VOLUME ▲ or VOLUME ▼ .
  - ◇ *The feature must be active to change the volume. Press the volume keys when the telephone is idle to adjust the display contrast.*



## Warning Tone for Long Conversation



### Description

The system can broadcast warning tones to a trunk caller, warning the caller that he has been on the call too long. If he chooses, the caller can disregard the tones and continue talking. The outside caller does not hear the warning tones. Warning tones do not occur for Intercom calls and most incoming trunk calls. DISA trunks can also have warning tones. Warning tones are not available to analog single line telephone (SLT) users.

There are two warning tones: Alarm Tone 1 and Alarm Tone 2. Alarm Tone 1 is the first set of tones that occur after the user initially places a trunk call. Alarm Tone 2 broadcasts periodically after Alarm Tone 1 as a continued reminder. Each alarm tone consists of three short beeps.

If programmed, DISA calls are disconnected unless the continue code is entered by the user. With the Long Conversation Cutoff feature, incoming or outgoing central office calls can also be disconnected.

### Warning Tone for DISA Callers

For DISA callers, with this feature enabled, the warning tone timer begins when an incoming DISA call places an outgoing call and either the inter-digit timer expires or the outgoing call is answered.

If an outside call is transferred to forwarded off-premise using an outside trunk, the warning tone timer begins immediately. This occurs only if either trunk involved in the call is programmed for this feature (Program 14-01-17). When transferring a trunk call off-premise, Program 14-01-13 must be enabled (set to 1).

### Conditions

- Warning Tone for Long Conversation does not occur for incoming trunk calls.
- Warning Tone for Long Conversation occurs for all outgoing trunk calls, regardless of how they are placed or other outgoing restrictions.
- Warning Tone for Long Conversation can be enabled for DISA calls.
- Warning Tone for Long Conversation does not occur for Intercom calls.
- Warning Tone for Long Conversation can be used with the Long Conversation Cutoff feature for outgoing calls.
- Warning Tone is presented on a single line telephone in the ear piece.

## Default Setting

Disabled

## Related Features

- [Central Office Calls, Answering](#)
- [Central Office Calls, Placing](#)
- [Code Restriction](#)
- [Direct Inward System Access \(DISA\)](#)
- [Intercom](#)
- [Long Conversation Cutoff](#)
- [Single Line Telephones, Analog 500/2500 Sets](#)

## Guide to Feature Programming

The **Level 1**, **Level 2** and **Level 3** columns indicate the programs that are assigned when programming this feature in the order they are most commonly used. These levels are used with PCPro and WebPro wizards for feature programming.

- Level 1 – these are the most commonly assigned programs for this feature.
- Level 2 – these are the next most commonly assigned programs for this feature.
- Level 3 – these programs are not often assigned and require an expert level working knowledge of the system to be properly assigned.

Program Number	Program Name/Description	Input Data	Default	Level		
				1	2	3
14-01-17	<b>Basic Trunk Data Setup – Trunk to Trunk Warning Tone for Long Conversation Alarm</b> Determine whether DISA callers should hear the Warning Tone for Long Conversations.	0 = Disable 1 = Enable	0	✓		
14-01-25	<b>Basic Trunk Data Setup – Continued/ Discontinued Trunk-to-Trunk Conversation</b> When Program 24-02-10 is set to disconnect a trunk after the defined time, determine whether or not a user can use the continue/discontinued code.	0 = Disable 1 = Enable	0	✓		

Program Number	Program Name/Description	Input Data	Default	Level		
				1	2	3
20-06-01	<b>Class of Service for Extensions</b> Assign a Class of Service (1 ~ 15) to an extension.	Day Night/Mode: 1 ~ 8 Class of Service of Extensions (1 ~ 15)	Extension port 101 = Class 15 All other extension port = Class 1	✓		
20-13-01	<b>Class of Service Options (Supplementary Service) – Long Conversation Alarm</b> Turn Off or On the Warning Tone for Long Conversation (not for single line telephones).	0 = Off 1 = On	COS 1 ~ 15 = 0	✓		
20-21-01	<b>System Options for Long Conversation – Long Conversation Alarm 1</b> After a user places a trunk call, the system sends the first warning tone to their extension after this time.	0 ~ 64800 seconds	170		✓	
20-21-02	<b>System Options for Long Conversation – Long Conversation Alarm 2</b> After hearing the first warning tone, the system sends additional warning tones after this time. The warning tones continue, spaced by this time, until the user hangs up.	0 ~ 64800 seconds	180		✓	
20-28-01	<b>Trunk to Trunk Conversation – Conversation Continue Code</b> Input the code that can be dialed to continue the conversation after the Trunk-to-Trunk Release Warning Tone is heard.	0 ~ 9, #, *	No Setting	✓		
20-28-02	<b>Trunk to Trunk Conversation – Conversation Disconnect Code</b> Input the code that can be dialed to disconnect the conversation after the Trunk-to-Trunk Release Warning Tone is heard.	0 ~ 9, #, *	No Setting	✓		
20-28-03	<b>Trunk to Trunk Conversation – Conversation Continue Time</b> When Program 14-01-25 is enabled, determine the time a call is extended when the user dials the Continue code defined in Program 20-28-01.	0 ~ 64800 seconds	0	✓		
21-01-01	<b>System Options for Outgoing Calls – Seizure Trunk Line Mode</b> Select the trunk based on the Trunk Route Priority (0) or based on the trunk that has not been used in the longest time (1).	0 = Priority Route 1 = Circular Route	0		✓	
21-01-03	<b>System Options for Outgoing Calls – Trunk Interdigit Time (External)</b> The system waits for this time to expire before placing the call in a talk state (Call Timer starts after time expires. Voice Over and Barge-In are not allowed until after time expires).	0 ~ 64800 seconds	5		✓	

Program Number	Program Name/Description	Input Data	Default	Level		
				1	2	3
25-07-07	<b>System Timers for VRS/DISA – Long Conversation Warning Tone Time</b> Determine the time a DISA caller or any trunk-to-trunk (Such as Tandem Trunking) conversation can talk before the Long Conversation tone is heard.	0 ~ 64800 seconds	3600		✓	
25-07-08	<b>System Timers for VRS/DISA – Long Conversation Disconnect Time</b> Determine the time the system waits before disconnecting a DISA caller or any trunk-to-trunk (Such as Tandem Trunking) conversation call after the Long Conversation tone is heard.	0 ~ 64800 seconds	10		✓	

## Operation

Warning Tone for Long Conversation is automatic if programmed.

### Warning Tone for Long Conversation for DISA Callers:

1. A DISA caller dials into the system and places a call.
2. After the Warning Tone is heard, **To continue the call** the DISA caller can press the programmed Continue Code.

- OR -

**To disconnect the call**, the DISA caller can press the programmed Disconnect Code.

*Wireless DECT (SIP)*

Description

The Wireless DECT (SIP) (Digital Enhanced Cordless Telecommunication) system allows using DECT 6.0 DECT (SIP) handsets. These handsets provide the freedom and convenience of a wireless telephone but also allow access to features provided by the UNIVERGE SV9100 system.

The number of Wireless DECT (SIP) handsets supported by the UNIVERGE SV9100 is dependent on the number of SIP Client licenses.

[Table 2-165 Supported Wireless DECT \(SIP\) Features](#) lists the SV9100 features supported on the Wireless DECT (SIP).

*Table 2-165 Supported Wireless DECT (SIP) Features*

Feature Name	SIP DECT	Comments SIP DECT
Account Code - Forced/Verified/Unverified	Yes	
Account Code Entry	Yes	
Alarm	No	
Alarm Reports	No	
Alphanumeric Display	Yes	IP DECT Handsets have Alphanumeric Display and are backlit. However, the display is not updated with CPU messages
Analog Communications Interface (ACI)	No	
Ancillary Device Connection	No	
Answer Hold	No	
Answer Key	No	
Attendant Call Queuing	No	
Automatic Release	Yes	
Automatic Route Selection (ARS)	Yes	
Background Music	No	
Barge-In	No	
Battery Backup – System Memory	N/A	
Battery Backup – System Power	N/A	
Call Appearance (CAP) Keys	No	
Call Arrival (CAR) Keys	No	
Call Duration Timer	Yes	SIP DECT handset timer not system timer.
Call Forwarding – Centrex	Yes	

Table 2-165 Supported Wireless DECT (SIP) Features (Continued)

Feature Name	SIP DECT	Comments SIP DECT
Call Forwarding	Yes	Must be programmed in 24-09 or through feature code in handset.
Call Forwarding with Follow Me	No	
Call Forwarding, Off-Premise	Yes	
Call Forwarding/Do Not Disturb Override	Yes	
Call Monitoring	No	
Call Redirect	No	
Call Waiting/Camp-On	Yes	Can only set Camp-On to IP DECT handset from softkey menu of multiline terminal, not with access codes.
Callback	No	
Caller ID Call Return	N/A	
Caller ID	Yes	Only on ISDN or SIP Trunks. Analog Caller ID is not supported.
Central Office Calls, Answering	Yes	
Central Office Calls, Placing	Yes	
Class of Service	Yes	
Clock/Calendar Display	No	
CO Message Waiting Indication	No	
Code Restriction	Yes	
Code Restriction Override	Yes	
Code Restriction, Dial Block	Yes	
Computer Telephony Integration (CTI) Applications	No	
Conference	No	
Conference, Voice Call/Privacy Release	No	
Contact Center	No	
Cordless Telephone Connection	No	
Data Line Security	Yes	Barge-In is not supported.
Delayed Ringing	No	
Department Calling	No	
Department Step Calling	Yes	
Dial Pad Confirmation Tone	No	
Dial Tone Detection	No	
Dialing Number Preview	Yes	
Direct Inward Dialing (DID)	Yes	

Table 2-165 Supported Wireless DECT (SIP) Features (Continued)

Feature Name	SIP DECT	Comments SIP DECT
Direct Inward Line (DIL)	Yes	
Direct Inward System Access (DISA)	Yes	
Direct Station Selection (DSS) Console	No	
Directed Call Pickup	Yes	
Directory Dialing	No	
Distinctive Ringing, Tones and Flash Patterns	No	
Do Not Disturb	No	
Do Not Disturb/Call Forward Override	Yes	
Door Box	Yes	Door Box will not ring IP DECT handset. IP DECT handset can call doorbox, but cannot activate the relay.
Drop Key	No	
D <sup>term</sup> Handset Cordless	No	
D <sup>term</sup> IP Gateway System	No	
E911 Compatibility	Yes	
Facsimile CO Branch Connection	No	
Flash	Yes	
Flexible System Numbering	Yes	SIP DECT numbering controlled through IP DECT Manager application.
Flexible Timeouts	Yes	
Forced Trunk Disconnect	No	
Group Call Pickup	Yes	
Group Listen	No	
Handset Mute	Yes	
Handsfree and Monitor	Yes	Handsfree is supported by handset.
Handsfree Answerback/Forced Intercom Ringing	No	
Headset Operation	Yes	
Hold	Yes	
Hotel/Motel	No	
Hotline	Yes	Handset can be a hotline destination, but cannot originate a hotline call.
Howler Tone Service	No	
InMail	Yes	
Intercom	Yes	
Intercom Off-Hook Signaling	Yes	

Table 2-165 Supported Wireless DECT (SIP) Features (Continued)

Feature Name	SIP DECT	Comments SIP DECT
IP Multiline Station (SIP)	No	
IP Trunk – (SIP) Session Initiation Protocol	Yes	
IP Trunk – H.323	No	
ISDN Compatibility	Yes	
K-CCIS – IP	Yes	
K-CCIS – T1	Yes	
Last Number Redial	No	Redial built in.
Line Preference	No	
Long Conversation Cutoff	Yes	
Meet Me Conference	No	
Meet Me Paging	Yes	
Meet Me Paging Transfer	Yes	
Memo Dial	No	Internal phone book. Capacity varies with handset model.
Message Waiting	Yes	Only VM Message Waiting can be received.
Message Waiting Answer	Yes	
Microphone Cutoff	Yes	Handset has mute function.
Multiple Trunk Types	Yes	
Music on Hold	Yes	
Name Storing	No	
NEC Communications Analyst	Yes	
NEC Interactive Voice Response	No	
Night Service	No	
Off-Hook Signaling	Yes	
Off-Hook Signaling Override	Yes	
One-Touch Calling	No	
Operator	Yes	
(OPX) Off-Premise Extension	No	
Paging, External	Yes	IP DECT handset can only initiate a page, it cannot receive a page or display page information.
Paging, Internal	Yes	IP DECT handset can only initiate a page, it cannot receive a page or display page information.
Park	No	
PBX Compatibility	Yes	



Table 2-165 Supported Wireless DECT (SIP) Features (Continued)

Feature Name	SIP DECT	Comments SIP DECT
PC Programming	Yes	IP stations can be programmed from PCPro for IP duplication.
Power Failure Transfer	No	
Prime Line Selection	Yes	
Private Line	Yes	
Programmable Function Keys	No	
Programming from a Multiline Terminal	N/A	
Pulse to Tone Conversion	No	
Redial Function	No	Handset has redial list.
Quick Transfer to Voice Mail	Yes	MLTs can q/t to the SIP DECT VM, but SIP DECT handset cannot execute Q/T.
Remote (System) Upgrade	N/A	
Repeat Redial	No	
Resident System Program	N/A	
Reverse Voice Over	No	
Ring Groups	Yes	
Ringdown Extension, Internal/External	Yes	IP DECT handset can only be the ringdown destination. It cannot initiate ringdown.
Room Monitor	No	
Save Number Dialed	No	Handsets have own phone book and redial lists
Secondary Incoming Extension	No	
Secretary Call (Buzzer)	No	
Secretary Call Pickup	No	
Selectable Display Messaging	No	
Selectable Ring Tones	Yes	Ring tones are selectable at the handset level, specific to the type of call.
Serial Call	No	
Single Line Telephones, Analog 500/2500 Sets	No	
Softkeys	No	All keys are fixed in C124 handset.
Speed Dial - System/Group/Station	No	
Station Hunt	No	
Station Message Detail Recording	Yes	
Station Name Assignment – User Programmable	Yes	Handset name can be programmed in the handset (it does not show the name in Program 15-01-01), but will not display back to IPK II callers.

Table 2-165 Supported Wireless DECT (SIP) Features (Continued)

Feature Name	SIP DECT	Comments SIP DECT
Station Relocation	No	
Step Call	Yes	
SV9100 PoE Gigabit Switch	No	
SV9100 UC Suite	No	
SV9100 Terminals	No	
Synchronous Ringing	Yes	
T1 Trunking (with ANI/DNIS Compatibility)	Yes	
Tandem Ringing	No	
Tandem Trunking (Unsupervised Conference)	Yes	Only Tandem Trunking on hangup is supported with IP DECT.
TAPI Compatibility	No	
Tone Override	No	
Traffic Reports	No	
Transfer	Yes	
Trunk Group Routing	Yes	
Trunk Groups	Yes	
Trunk Queuing/Camp-On	No	
UM8000 Mail	No	
Uniform Call Distribution (UCD)	No	
Uniform Numbering Network	Yes	
Universal Slots	N/A	
User Programming Ability	Yes	Limited user customization available.
Virtual Extensions	No	
Voice Call & Signal Switching	Yes	Can only send voice/signal switch, not receive.
Voice Mail Integration (Analog)	Yes	
Voice Mail Message Indication on Line Keys	No	
Voice Over	No	
Voice Over Internet Protocol (VoIP)	Yes	By nature, this is a SIP device.
Voice Response System (VRS)	N/A	
Voice Response System (VRS) – Call Forwarding – Park and Page	Yes	
Volume Controls	Yes	
Warning Tone for Long Conversation	Yes	
Wireless – DECT	No	

Components of the Wireless DECT (SIP) system include the following:

**NEC C124 SIP DECT Handset**

The handset has the following features:

- Alphanumeric Display with Backlight
- LED Indication for Incoming Calls
- Telephone Book with 40 entries  
While idle, dial the number to be stored, then press > and OK. Enter the name associated with the number using the dial pad, and press OK.
- Silent Mode (mute all sounds)
- Redial Function (last 10 numbers)  
Press ▲ and continue to press ▼ to scroll through the numbers. Press Hook key to dial a number.
- Programming Pause  
A long press on # adds a pause to pre-dial or phone book numbers.
- Adjustable Volume  
Ring volume can be adjusted using ▲ and ▼ on the handset.
- Key Lock  
Press OK and \* to lock the dial pad.
- Ten Different Ring Tones  
Ring tones can be selected in the tone setup menu and press OK.
- Microphone Mute  
Press ⊗ while the telephone is off-hook to mute the microphone.
- Caller ID Presentation
- Headset Connection
- R-Key for Transfer and Special Services  
When off-hook, press R to Recall, transfer.

**Display Enhancements**

The SIP DECT handset can now receive the calling party name on an incoming internal/external call. The priority for the display is as follows:

If calling from a standard SIP terminal:

1. Program 15-05-04 nick name.
2. Program 15-01-01 extension name.
3. Calling name from originating standard SIP caller.
4. Extension number.

If calling from an SLT, DT300 (including virtual extensions) or a DT700:

1. Program 15-01-01 Extension name.
2. Extension number.

If calling from a trunk, (i.e. SIP trunk, ISDN, Analog C.O.):

1. Calling party name of incoming trunk. (Caller ID information).
2. Program13-04-02 abbreviated dial Name (with matching caller ID).
3. Calling party number.

For trunks, new Program 15-05-40 controls what is displayed and has the following options:

1. Both Name and Number.
2. Name only.
3. Number only.
4. None.

If calling from Voice Mail:

1. Program 45-01-02 Voice Mail master Name.
2. Program 45-01-09 Centralized Voice Mail Master name.
3. Program 15-01-01 Calling station information (Voicemail extension).

## Conditions

- Program 15-05-17 is no longer used.
- Program 32-04-01 Door Phone Name is not supported.
- Hold recall will not display calling name.
- Transfer recall will not display calling name.
- Alarm is not supported.
- Call forward from trunk is not supported.
- The system has the ability to receive DTMF information in SIP INFO messages sent by Standard SIP Terminals. This allows the SIP Terminal to initiate features during a ringing state such as Camp-On and Message Waiting.

NEC G955 SIP DECT Handset

Features	Description	
Call Handling Features	<ul style="list-style-type: none"> <li>○ Automatic Call answer</li> <li>○ Caller log</li> <li>○ CLI (name and number support): when available in a directory presented by name</li> <li>○ Last number redial</li> <li>○ Recall/hold (inquiry)</li> <li>○ Standby time: 120 hours</li> </ul>	<ul style="list-style-type: none"> <li>○ Call reject option</li> <li>○ Caller filter</li> <li>○ Crystal clear speech and seamless handover</li> <li>○ On-hook number preparation</li> <li>○ Silent charging</li> <li>○ Talk time: 12 hours</li> </ul>
Directory	<ul style="list-style-type: none"> <li>○ Phone book multiple numbers per contact</li> </ul>	<ul style="list-style-type: none"> <li>○ Personal phone book</li> </ul>
Display	<ul style="list-style-type: none"> <li>○ Color Graphic TFT display 160 X 128 pixels (262k)</li> </ul>	<ul style="list-style-type: none"> <li>○ Illuminated display: Incoming calls and messages</li> </ul>
Headset	<ul style="list-style-type: none"> <li>○ Headset support</li> </ul>	<ul style="list-style-type: none"> <li>○ Bluetooth headset support: via additional Bluetooth module</li> </ul>
Keys	<ul style="list-style-type: none"> <li>○ Function and keypad keys: 24 keys with 12 keypad keys (0~9, *, #), with text mode support</li> <li>○ Recall or inquiry key</li> <li>○ Menu navigation keys: programmable short keys, up, down, left, right</li> <li>○ Power On/Off key</li> </ul>	<ul style="list-style-type: none"> <li>○ On and off-hook key: 2 separate keys</li> <li>○ Increase and decrease volume</li> <li>○ OK/confirm key</li> <li>○ Programmable softkeys (2 keys menu dependent function)</li> <li>○ Keypad lock</li> </ul>
Localization	<ul style="list-style-type: none"> <li>○ Multiple supported languages: 13</li> </ul>	<ul style="list-style-type: none"> <li>○ Triple frequency band</li> </ul>
Menu	<ul style="list-style-type: none"> <li>○ Easy menu programming</li> </ul>	
Mobility/Other	<ul style="list-style-type: none"> <li>○ Multiple subscriptions DECT systems: 8 DECT systems</li> </ul>	
Sound/Audio	<ul style="list-style-type: none"> <li>○ Adjustable ringer volume</li> <li>○ Loudspeaker mode/hands free</li> <li>○ Adjustable earpiece/loudspeaker volume</li> </ul>	<ul style="list-style-type: none"> <li>○ Microphone mute</li> <li>○ Silent ring support</li> </ul>
Security	<ul style="list-style-type: none"> <li>○ Automatic encryption for secure calls</li> </ul>	
Service/Maintenance	<ul style="list-style-type: none"> <li>○ Software upgrading via air interface</li> <li>○ Easy subscription to another handset: by transferring memory card to another handset</li> </ul>	<ul style="list-style-type: none"> <li>○ Backup of local data storage: via additional 64k memory card</li> </ul>
User Data	<ul style="list-style-type: none"> <li>○ Internal memory: for storage of local data</li> <li>○ Storage of local user data: personal phone book, caller log, caller filter and calender entries</li> </ul>	<ul style="list-style-type: none"> <li>○ Memory card: the storage capacity can be doubled by adding a memory card. The memory card also contains the subscription information</li> </ul>
User Interface	<ul style="list-style-type: none"> <li>○ Visible indicators: Icon driven menu</li> <li>○ Distinctive melodies for messages and priorities</li> <li>○ Status line indicators in the display</li> </ul>	<ul style="list-style-type: none"> <li>○ Ringer tones/melodies: 20 distinctive melodies for external, internal calls</li> <li>○ Audible indicators are user selectable</li> </ul>

- 12 simultaneous calls can be made per DECT Access Point.
- When the Wireless DECT (SIP) telephone does not respond to an incoming call within 12 seconds because it is out of area, the originator hears a busy tone.
- The Out of Area Timer is fixed at eight seconds (Program 20-22-05).
- The maximum number of Wireless DECT (SIP) handsets is 255.
- The maximum number of DAPs is 256.

- Wireless DECT (SIP) is not supported with .
- Off hook signaling is supported with Wireless DECT (SIP) telephones.
- When replacing the batteries in a C124, G355 or G955 handset, it is necessary to place the handset on the charger for 10 seconds in order to update the battery status indicator.
- NAT or NAPT is only supported on the DT700 series phones. NAT or NAPT is not supported on the ML440, the Wireless DECT (SIP) or Softphone.
- The DECT Access Point Configurator does not support Windows 10.

# Off-Hook Signaling

## Description

This feature enables the display of off-hook signaling on an IP DECT terminal while talking with the 1st call.

Figure 2-117 IP DECT – 2nd Indication

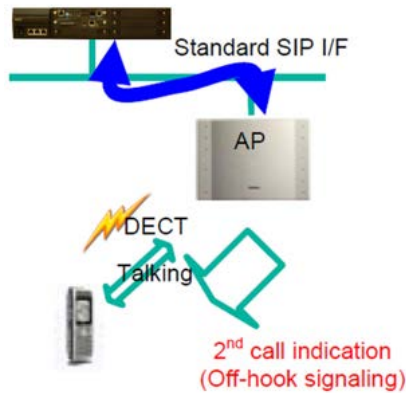

## Conditions

- Multiple call appearance and call waiting indication must be turned on for the SIP DECT system using the IP DECT configurator **V 5.0.1.4 or higher**.
- Program 20-13-54 must be turned on for the class of service the DECT telephone is in.
- If Program 20-13-06 is set on, IP DECT receives an off-hook signaling automatically. If Program 20-13-06 is set off, the 2nd caller hears a busy tone. If the override code is dialed (Program 11-12-03 SC 709) and overrides SC (Program 11-12-03), then the IP DECT receives off-hook signals manually.
- Off-hook signaling is supported from an extension, voicemail and trunk call.
- If a SIP DECT extension is talking to a voice mail port, the system does not send an off-hook signal. Once the SIP DECT disconnects from voice mail, SIP DECT can answer the 2nd call.
- If the 1st call is an extension and the 2nd call is a voice mail, IP DECT answers the 2nd call by pressing the \* button, but can not go back to the 1st call by pressing the \* button. To reconnect to the 1st call again, IP DECT has to disconnect the 2nd call and wait for recall of the 1st call.
- With SV9100 software and GPZ-IPLE daughter board installed, half duplex connections are not supported. For troubleshooting purposes, a managed switch capable of port mirroring is required to capture packet data from the SV9100 IPLE Ethernet port.

## Caller ID Display After a Call Transfer

### Description

Previously in case of screened transfer, if a call was from a trunk line or legacy terminal, etc, the transferrer's calling party number was displayed in IP DECT. In case of an unscreened transfer, the calling party number from where the call was transferred is displayed on the IP DECT.

This feature enables the IP DECT terminal to display the calling party number of the original caller (Transferee) when making a screened or unscreened transfer to an IP DECT terminal.

Figure 2-118 IP DECT – Caller ID Display

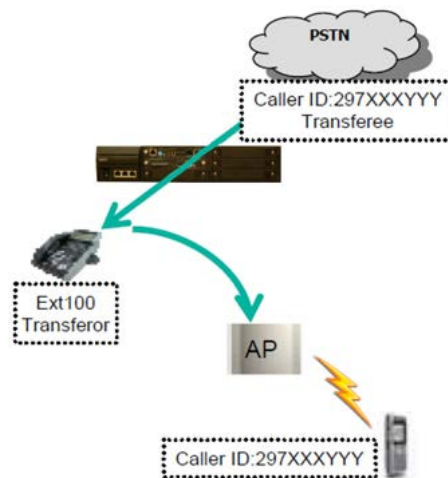

### Conditions

- Calling party name is not supported in this feature.
- In case of a screened transfer, when the transfer is made, IP DECT shows the calling party number of the original caller (Transferee) after answering the call.
- In case of an unscreened transfer, when the transfer is made, IP DECT shows the calling party number of the original caller (Transferee) before (and after) answering the call.
- With SV9100 software and GPZ-IPLE daughter board installed, half duplex connections are not supported. For troubleshooting purposes, a managed switch capable of port mirroring is required to capture packet data from the SV9100 IPLE Ethernet port.



## Out of Range Call Warning Notification

### Description

With SV9100 software, it is possible to determine when a SIP-Dect terminal is Out of Range or powered off. When an internal caller calls the Out of Range SIP terminal, either a lock out tone or call forwarding can be performed. When the Out of Range timer (Program 24-02-15) expires, CFW is performed when Program 24-09-01 is set to 2-5 and the dial is set to the suitable place of Program 24-09-02~24-09-05. If CFW is not set, the calling terminal hears a Lock-out tone and the following Out of Range notice is displayed on the originators LCD.

Figure 2-119 Out of Range Example

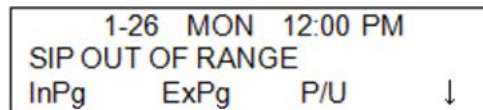

### Conditions

- When a call comes into an idle SIP terminal which has not been recognized as out of range, the system waits for the timer in Program24-02-15 (default 4 sec) to expire to determine if the terminal is Out of Range state or not.
- Out of Range transfer works against the SIP terminal in an Out of Range state when Program 24-09-01 is set to a value between 2 and 5 (2: No Answer, 3: Immediate, 4: Busy/ No Answer or 5: Busy). In case of a value of 0 or 1 (0: None or 1: Both), Out of Range transfer does not work.
- When the SIP terminal starts ringing and then moves to out of range, the terminal keeps ringing because the terminal is no longer under the control of the system. In this case the Out of Range transfer is not applied.
- Out of Range Transfer is only applied to calls that ring directly to the SIP Terminal. Group Calls, Paging, and Call Forward Both Ring are not supported.
- In case of Ring Transfer to the SIP terminal Out of Range transfer is not applied. It follows No Answer timer in Program 24-02-03.
- In case of internal call from other standard SIP terminal, lock-out tone is not applied. Caller hears a busy tone.

### Default Settings

Enabled

## System Availability

### Terminals

- NEC C124 SIP DECT Handset
- NEC G955 SIP DECT Handset
- IP DECT
  - ◇ Standard SIP terminals have not been evaluated with this feature.

### Required Component(s)

- NEC DECT Access Point AP200S
- NEC SIP DECT Handset - NEC C124/G955
- 0411 – SV9100 Version Lic (R1)
- 0300 – SV9100 Resource Lic
- 5103 – SV9100 IP Resource Lic
- 5111 – SV9100 IP Phone Lic

## Related Features

- ➔ **Caller ID**
- ➔ **Off-Hook Signaling**
- ➔ **Transfer**
- ➔ **Wireless DECT (SIP)**

## Guide to Feature Programming

The **Level 1**, **Level 2** and **Level 3** columns indicate the programs that are assigned when programming this feature in the order they are most commonly used. These levels are used with PCPro and WebPro wizards for feature programming.

- Level 1 – these are the most commonly assigned programs for this feature.
- Level 2 – these are the next most commonly assigned programs for this feature.
- Level 3 – these programs are not often assigned and require an expert level working knowledge of the system to be properly assigned.

VoIP Settings:

Program Number	Program Name/Description	Input Data	Default	Level		
				1	2	3
10-12-03	<b>GCD-CP10 Network Setup – Default Gateway</b> Assign the default gateway IP address for the GCD-CP10.	0.0.0.0 ~ 126.255.255.254 128.0.0.1 ~ 191.255.255.254 192.0.0.1 ~ 223.255.255.254	0.0.0.0	✓		
10-12-09	<b>GCD-CP10 Network Setup – IP Address</b> Set IP address for GPZ-IPLE.	0.0.0.0 ~ 126.255.255.254 128.0.0.1 ~ 191.255.255.254 192.0.0.1 ~ 223.255.255.254	172.16.0.10	✓		
10-12-10	<b>GCD-CP10 Network Setup – Subnet Mask</b> Define the Media Gateway Subnet Mask Address.	128.0.0.0   192.0.0.0   224.0.0.0  240.0.0.0   248.0.0.0   252.0.0.0  254.0.0.0   255.0.0.0  255.128.0.0   255.192.0.0  255.224.0.0   255.240.0.0  255.248.0.0   255.252.0.0  255.254.0.0   255.255.0.0  255.255.128.0   255.255.192.0  255.255.224.0   255.255.240.0  255.255.248.0   255.255.252.0  255.255.254.0   255.255.255.0  255.255.255.128  255.255.255.192  255.255.255.224  255.255.255.240  255.255.255.248  255.255.255.252  255.255.255.254  255.255.255.255	255.255.0.0		✓	
10-19-01	<b>VoIP DSP Resource Selection</b> Select type of VoIP ETU DSP Resource. This program setting has no affect on the terminal/trunk port assignment or usage.	0 = Common use for both IP extensions and trunks 1 = IP Extension 2 = SIP Trunk 3 = CCIS/Networking 4 = Use for NetLink 5 = Blocked 6 = Common without Unicast Paging 7 = Multicast Paging 8 = Unicast Paging	Resource 1 = 1 Resource 2 ~ 256 = 0	✓		
15-05-50	<b>IP Telephone Terminal Basic Data Setup – Peer to Peer Mode</b> On a per station basis enable or disable Peer to Peer mode.	0 = Disable 1 = Enable	1	✓		
84-06-01	<b>PVA Data Setting – RTP Port Number</b> Define the Media Gateway starting RTP Port Number.	0 ~ 65535	10020		✓	
84-06-02	<b>PVA Data Setting – RTCP Port Number</b> Define the Media Gateway Starting RTCP Port Number. The RTCP Port Number has to be the (RTP port number + 1).	RTP Port Number + 1	10021		✓	

Program Number	Program Name/Description	Input Data	Default	Level		
				1	2	3
84-06-04	<b>PVA Data Setting – Fract Lost Threshold</b> Define the fractional lost threshold. This data is sent to the GCD-CP10 if the value exceeds the defined value.	0 ~ 100%	0		✓	
84-06-05	<b>PVA Data Setting – Packets Lost Threshold</b> Define the packets lost threshold. This data is sent to the GCD-CP10 when the value exceeds the defined value.	0 ~ 16777215	0		✓	
84-06-07	<b>PVA Data Setting – Jitter Threshold</b> Define the Jitter Threshold. This data is sent to the GCD-CP10 when the value exceeds the defined value.	0 ~ 4294967295 seconds	0		✓	
84-06-09	<b>PVA Data Setting – Delay LSR Threshold</b> Define the Delay LSR threshold. This data is sent to the GCD-CP10 when the value exceeds the defined value.	0 ~ 4294967295 seconds	0		✓	

**VoIP ToS Setup:**



*The UNIVERGE SV9100 supports Quality of Service (QoS) Marking for the Session Initiation Protocol (SIP).*

Program Number	Program Name/Description	Input Data	Default	Level		
				1	2	3
84-10-01	<b>ToS Setup – ToS Mode</b> When Input Data is set to 1, Item No. 07 is invalid. When Data is set to 2, Items No. 02 ~ 06 are invalid.	0 = Disable (Invalid) 1 = IP Precedence 2 = Diffserv	0		✓	

**IP Extension Numbering:**

Program Number	Program Name/Description	Input Data	Default	Level		
				1	2	3
11-02-01	<b>Extension Numbering</b> Define the IP Phone extension number.	Dial (maximum of eight digits).	1 101 2 102 3 103 ~ ~ 99 199 100 3101 ~ ~ 960 3961	✓		

**SIP Extension CODEC Information:**

Program Number	Program Name/Description	Input Data	Default	Level		
				1	2	3
84-19-01	<b>SIP Extension CODEC Information Basic Setup – Number of G.711 Audio Frames</b> Define the G.711 audio Frame Size.	1 ~ 4 1 = 10ms 2 = 20ms 3 = 30ms 4 = 40ms	2		✓	
84-19-02	<b>SIP Extension CODEC Information Basic Setup – G.711 Voice Activity Detection Mode</b> Enable/Disable Voice Activity Detection for G.711.	0 = Disable 1 = Enable	0		✓	
84-19-03	<b>SIP Extension CODEC Information Basic Setup – G.711 Type</b> Define the G.711 Type – $\mu$ -law is recommended when in USA.	0 = A-law 1 = $\mu$ -law	1		✓	
84-19-04	<b>SIP Extension CODEC Information Basic Setup – G.711 Jitter Buffer (min)</b> Define G.711 Jitter Buffer minimum accepted value.	0 ~ 300ms	20		✓	
84-19-05	<b>SIP Extension CODEC Information Basic Setup – G.711 Jitter Buffer (average)</b> Define G.711 Jitter Buffer average accepted value.	0 ~ 300ms	40		✓	
84-19-06	<b>SIP Extension CODEC Information Basic Setup – G.711 Jitter Buffer (max)</b> Define G.711 Jitter Buffer maximum accepted value.	0 ~ 300ms	80		✓	
84-19-07	<b>SIP Extension CODEC Information Basic Setup – Number of G.729 Audio Frames</b> Define the G.729 audio Frame Size.	1 ~ 6 1 = 10ms 2 = 20ms 3 = 30ms 4 = 40ms 5 = 50ms 6 = 60ms	2		✓	
84-19-08	<b>SIP Extension CODEC Information Basic Setup – G.729 Voice Activity Detection Mode</b> Enable/Disable Voice Activity Detection for G.729.	0 = Disable 1 = Enable	0		✓	
84-19-09	<b>SIP Extension CODEC Information Basic Setup – G.729 Jitter Buffer (min)</b> Define G.729 Jitter Buffer minimum accepted value.	0 ~ 300ms	20		✓	
84-19-10	<b>SIP Extension CODEC Information Basic Setup – G.729 Jitter Buffer (average)</b> Define G.729 Jitter Buffer average accepted value.	0 ~ 300ms	40		✓	

Program Number	Program Name/Description	Input Data	Default	Level		
				1	2	3
84-19-11	<b>SIP Extension CODEC Information Basic Setup – G.729 Jitter Buffer (max)</b> Define G.729 Jitter Buffer maximum accepted value.	0 ~ 300ms	80		✓	
84-19-17	<b>SIP Extension CODEC Information Basic Setup – Jitter Buffer Mode</b> Define the Jitter Buffer mode.	1 = Static 3 = Self Adjusting	3		✓	
84-19-18	<b>SIP Extension CODEC Information Basic Setup – VAD Threshold</b> Define the VAD Threshold. Consult the UNIVERGE SV9100 Programming Manual for Threshold scale to set acceptable values.	0 ~ 30 dB	20		✓	
84-19-28	<b>SIP Extension CODEC Information Basic Setup – Audio Capability Priority</b> Define Audio Capability Priority.	0 = G.711_PT 2 = G.729_PT 3 = G.722 4 = G.726 5 = Not Used	0		✓	
84-19-33	<b>SIP Extension IP CODEC Information Basic Setup – Number of G.722 Audio Frames</b> Define the number of Audio Frames for G.722 CODEC.	1 ~ 4 1 = 10ms 2 = 20ms 3 = 30ms 4 = 40ms	3		✓	
84-19-35	<b>SIP Extension IP CODEC Information Basic Setup – G.722 Jitter Buffer (min)</b> Define the minimum setting for the G.722 Jitter Buffer.	0 ~ 300ms	30		✓	
84-19-36	<b>SIP Extension IP CODEC Information Basic Setup – G.722 Jitter Buffer (Average)</b> Define the average setting for the G.722 Jitter Buffer.	0 ~ 300ms	60		✓	
84-19-37	<b>SIP Extension IP CODEC Information Basic Setup – G.722 Jitter Buffer (Max)</b> Define the maximum setting for the G.722 Jitter Buffer.	0 ~ 300ms	120		✓	
84-19-38	<b>SIP Extension IP CODEC Information Basic Setup – Number of G.726 Audio Frames</b> Define the number of G.726 Audio Frames.	1 ~ 4 1 = 10ms 2 = 20ms 3 = 30ms 4 = 40ms	3		✓	
84-19-39	<b>SIP Extension IP CODEC Information Basic Setup – G.726 Voice Activity Detection Mode</b> Enable/Disable the G.726 Voice Activity Detection Mode.	0 = Disable 1 = Enable	0		✓	

Program Number	Program Name/Description	Input Data	Default	Level		
				1	2	3
84-19-40	<b>SIP Extension IP CODEC Information Basic Setup – G.726 Jitter Buffer (min)</b> Define the minimum setting for the G.726 Jitter Buffer.	0 ~ 300ms	30		✓	
84-19-41	<b>SIP Extension IP CODEC Information Basic Setup – G.726 Jitter Buffer (Average)</b> Define the average setting for the G.726 Jitter Buffer.	0 ~ 300ms	60		✓	
84-19-42	<b>SIP Extension IP CODEC Information Basic Setup – G.726 Jitter Buffer (Max)</b> Define the maximum setting for the G.726 Jitter Buffer.	0 ~ 300ms	120		✓	

**SIP Extension Basic Information Setup:**

Program Number	Program Name/Description	Input Data	Default	Level		
				1	2	3
84-20-01	<b>SIP Extension Basic Information Setup – Registrar/Proxy Port</b> Define SIP station Proxy Port.	1 ~ 65535	5070		✓	
84-20-02	<b>SIP Extension Basic Information Setup – Session Timer Value</b> Define the periodic refresh time that allows both user agents and proxies to determine if the SIP session is still active.	0 ~ 65535 seconds	180		✓	
84-20-03	<b>SIP Extension Basic Information Setup – Minimum Session Timer Value</b> Define the minimum allowed value for the SIP session timer.	0 ~ 65535 seconds	180		✓	
84-20-04	<b>SIP Extension Basic Information Setup – Called Party Info</b> Define the SIP Extension presented Caller ID information.	0 = Request URI 1 = To Header	0		✓	
84-20-05	<b>SIP Extension Basic Information Setup – Expire Value of Invite</b> Define the time out response value for SIP invite.	0 ~ 256 seconds	180		✓	
84-26-01	<b>IPL Basic Setup – IP Address</b> Assign the IP address for the DSP on the GPZ-IPLE.	xxx.xxx.xxx.xxx	Slot 1 = 172.16.0.20	✓		
84-26-02	<b>IPL Basic Setup – RTP Port Number</b> Assign the RTP port number to be used for each DSP on the GPZ-IPLE. ➡ Only even numbered ports are supported.	0 ~ 65534	VoIP GW1 = 10020		✓	

Program Number	Program Name/Description	Input Data	Default	Level		
				1	2	3
84-26-03	<b>IPL Basic Setup – RTCP Port Number (RTP Port Number + 1)</b> Assign the RTCP port number to be used for each DSP on the GPZ-IPLE.	0 ~ 65534	VoIP GW1 = 10021		✓	

**IP Phone Configuration:**

Program Number	Program Name/Description	Input Data	Default	Level		
				1	2	3
15-01-01	<b>Basic Extension Data Setup – Extension Name</b> Define the extension/virtual extension name.	Maximum of 12 characters.	STA 101 = Ext 101 STA 102 = Ext 102, etc.	✓		
15-05-02	<b>IP Telephone Terminal Basic Data Setup – IP Phone Fixed Port Assignment</b> MAC Address of registered MLT SIP phone is stored and/or can input the MAC address of an MLT SIP phone so when it comes online it is provided with the extension which the MAC address matches.	MAC address 00-00-00-00-00-00 to FF-FF-FF-FF-FF-FF	00-00-00-00-00-00	✓		
15-05-07	<b>IP Telephone Terminal Basic Data Setup – Using IP Address</b> Review the registered IP Phones IP Address [Informational Only].	0.0.0.0 ~ 255.255.255.255	0.0.0.0	✓		
15-05-15	<b>IP Telephone Terminal Basic Data Setup – CODEC Type</b> Assign the registered IP Phone Codec type of the MLT SIP – Reference Program 84-11 Dterm IP Codec Basic Information.	1-Type 1 2-Type 2 3-Type 3 4-Type 4 5-Type 5	1	✓		
15-05-16	<b>Authentication Password</b> Assign the authentication password for SIP single line telephones.	Maximum of 24 characters.	No Setting	✓		
15-05-18	<b>IP Telephone Terminal Basic Data Setup – IP Duplication Allowed Group</b> For an adapter that has one IP address coming into it but multiple extensions off of it. Enable this option for all extensions in the group so the CPU knows that the one IP Address is assigned to multiple extensions.	0 = Disable 1 = Enable	0	✓		
15-05-40	<b>IP Telephone Terminal Basic Data Setup – Calling Name Display Info via Trunk for Standard SIP</b> Sets the incoming calling name display type on a standard SIP terminal. Trunk name is the first priority and abbreviated (SPD) name is second priority.	0 = Both name and number 1 = Name only 2 = Number only 3 = None	0		✓	



Program Number	Program Name/Description	Input Data	Default	Level		
				1	2	3
15-05-49	<b>IP Telephone Terminal Basic Data Setup – Receiving SIP INFO</b> Select whether or not system can receive DTMF from standard SIP phone via SIP INFO message.	0 = Disable 1 = Allowed any time 2 = Allowed while RTP is not available	1		✓	

**Off-Hook Signaling:**

Program Number	Program Name/Description	Input Data	Default	Level		
				1	2	3
11-12-03	<b>Service Code Setup (for Service Access) – Override (Off-Hook Signaling)</b> Customize the override (off-hook signaling) used for service access.	MLT, SLT 0 ~ 9, *, # Maximum of eight digits	709	✓		
20-09-01	<b>Class of Service Options (Incoming Call Service) – Second Call for DID/DISA/DIL/ E&amp;M Override</b> Turn Off or On the extension ability to receive a second call from a DID, DISA, DIL, or tie line caller. ➡ <i>With this option set to 1, the destination extension must be busy for a second DNIS caller to ring through. If the destination extension does not have a trunk or CAP key available for the second call and a previous call is ringing the extension but has not yet been answered, the second caller hears busy regardless of this program setting.</i>	0 = Off 1 = On	COS 1 ~ 15 = 1		✓	
20-09-07	<b>Class of Service Options (Incoming Call Service) – Call Queuing</b> Turn Off or On an extension user ability to have calls queued if a call rings the extension when it is busy. ➡ <i>Program 20-13-06 must be set to 0 (Off) for this feature to work.</i>	0 = Off 1 = On	COS 1 ~ 15 = 1		✓	
20-13-05	<b>Class of Service Options (Supplementary Service) – Intercom Off-Hook Signaling</b> Turn Off or On an extension ability to send off-hook signals. ➡ <i>This setting functions with Programs 20-09-07 and 20-13-06 disabled.</i>	0 = Off 1 = On	COS 1 ~ 15 = 1		✓	
20-13-06	<b>Class of Service Options (Supplementary Service) – Automatic Off-Hook Signaling (Automatic Override)</b> Allows a busy extension to Manually (0) or Automatically (1) receive off-hook signals. ➡ <i>This setting is to receive incoming call signaling information during call queuing.</i>	0 = Off 1 = On	COS 1 ~ 15 = 1		✓	

Program Number	Program Name/Description	Input Data	Default	Level		
				1	2	3
20-13-54	<b>Class of Service Options (Supplementary Service) – Call Waiting for Standard SIP Terminal</b> Set up Call waiting (Off-hook Signaling) for Standard SIP terminal. When setting this Program to enable, Program 20-13-05, 20-13-06 and Program 20-09-01, 20-09-07 also need to be set to Enable.	0 = Disable 1 = Enable	0		✓	
20-17-01	<b>Operator Extension – Operator’s Extension Number</b> Define the extension numbers which are to be used by operators.	Maximum of eight digits.	ext. 101		✓	

**Caller ID Display After a Call Transfer:**

Program Number	Program Name/Description	Input Data	Default	Level		
				1	2	3
20-06-01	<b>Class of Service for Extensions</b> Assign a Class of Service (1 ~ 15) to an extension.	Day Night/Mode: 1 ~ 8 Class of Service of Extensions (1 ~ 15)	Extension port 101 = Class 15 All other extension port = Class 1		✓	
20-11-06	<b>Class of Service Options (Hold/Transfer Service) – Unscreened Transfer (Ring Inward Transfer)</b> Turn Off or On an extension user ability to use Unscreened Transfer.	0 = Off 1 = On	COS 1 ~ 15 = 1		✓	
24-02-15	<b>System Options for Transfer – SIP Out of Range Timer</b> When not receiving any response within this timer setting, system determines SIP terminal is out of range. When set to 0, timer is invalid.	0 ~ 30 seconds	4	✓		
24-09-01	<b>Call Forward Split Settings – Call Forwarding Type</b> Type of Call Forwarding	0 = Call Forwarding Off 1 = Call Forwarding with both ring 2 = Call Forwarding when no answer 3 = Call Forwarding all calls 4 = Call Forwarding busy or no answer 5 = Call Forwarding when busy	0	✓		

Program Number	Program Name/Description	Input Data	Default	Level		
				1	2	3
24-09-02	<b>Call Forward Split Settings – CO Call Forwarding Destination for Both Ring, All Call, No Answer</b> Assign CO Call Forwarding Destination for ring, all call and no answer.	Maximum of 24 digits (0 ~ 9, *, #, @, P, R) @ = Wait for Answer Supervision - ISDN trunks only P = Pause - Analog Trunk Only R = Hook flash - Analog Trunk Only	No Setting		✓	
24-09-03	<b>Call Forward Split Settings – Interim Call Forwarding Destination for Both Ring, All Call, No Answer</b> Assign Intercom Call Forwarding Destination for ring, all call and no answer.	Maximum of 24 digits (0 ~ 9, *, #, @, P, R) @ = Wait for Answer Supervision - ISDN trunks only P = Pause - Analog Trunk Only R = Hook flash - Analog Trunk Only	No Setting		✓	
24-09-04	<b>Call Forward Split Settings – CO Call Forwarding Busy Destination</b> Assign CO Call Forwarding for busy destinations.	Maximum of 24 digits (0 ~ 9, *, #, @, P, R) @ = Wait for Answer Supervision - ISDN trunks only P = Pause - Analog Trunk Only R = Hook flash - Analog Trunk Only	No Setting		✓	
24-09-05	<b>Call Forward Split Settings – Intercom Call Forwarding Busy Destination</b> Assign Intercom Call Forwarding for busy destinations.	Maximum of 24 digits (0 ~ 9, *, #, @, P, R) @ = Wait for Answer Supervision - ISDN trunks only P = Pause - Analog Trunk Only R = Hook flash - Analog Trunk Only	No Setting		✓	
80-01-01 (16)	<b>Service Tone Setup – Lockout Tone</b> Lock Out Tone Repeat Count.	Value 0 ~ 255	Refer to the Programming Manual for default values.			✓

**Out of Range Call Warning Notification:**

Program Number	Program Name/Description	Input Data	Default	Level		
				1	2	3
24-02-15	<b>System Options for Transfer – SIP Out of Range Timer</b> When not receiving any response within this timer setting, system determines SIP terminal is out of range. When set to 0, timer is invalid.	0 ~ 30 seconds	4	✓		

Program Number	Program Name/Description	Input Data	Default	Level		
				1	2	3
24-09-01	<b>Call Forward Split Settings – Call Forwarding Type</b> Type of Call Forwarding.	0 = Call Forwarding Off 1 = Call Forwarding with both ring 2 = Call Forwarding when no answer 3 = Call Forwarding all calls 4 = Call Forwarding busy or no answer 5 = Call Forwarding when busy	0		✓	
24-09-02	<b>Call Forward Split Settings – CO Call Forwarding Destination for Both Ring, All Call, No Answer</b> Assign CO Call Forwarding Destination for ring, all call and no answer.	Maximum of 24 digits (0 ~ 9, *, #, @, P, R) @ = Wait for Answer Supervision - ISDN trunks only P = Pause - Analog Trunk Only R = Hook flash - Analog Trunk Only	No Setting			✓
24-09-03	<b>Call Forward Split Settings – Interim Call Forwarding Destination for Both Ring, All Call, No Answer</b> Assign Intercom Call Forwarding Destination for ring, all call and no answer.	Maximum of 24 digits (0 ~ 9, *, #, @, P, R) @ = Wait for Answer Supervision - ISDN trunks only P = Pause - Analog Trunk Only R = Hook flash - Analog Trunk Only	No Setting			✓
24-09-04	<b>Call Forward Split Settings – CO Call Forwarding Busy Destination</b> Assign CO Call Forwarding for busy destinations.	Maximum of 24 digits (0 ~ 9, *, #, @, P, R) @ = Wait for Answer Supervision - ISDN trunks only P = Pause - Analog Trunk Only R = Hook flash - Analog Trunk Only	No Setting			✓
24-09-05	<b>Call Forward Split Settings – Intercom Call Forwarding Busy Destination</b> Assign Intercom Call Forwarding for busy destinations.	Maximum of 24 digits (0 ~ 9, *, #, @, P, R) @ = Wait for Answer Supervision - ISDN trunks only P = Pause - Analog Trunk Only R = Hook flash - Analog Trunk Only	No Setting			✓
80-01-01 (16)	<b>Service Tone Setup – Lockout Tone</b> Lock Out Tone Repeat Count.	Value 0 ~ 255	Refer to the Programming Manual for default values.			✓

## Operation

### Placing an outside call with pre-dial:

1. Dial **9**.

2. Press and hold the # key to insert a pause (–), if necessary.
3. Dial the outside number.
4. Press the  key (On-Hook/Off-Hook).



*For more information on the Wireless DECT (SIP) feature, refer to the NEC SIP DECT Solutions Manuals.*

## Off-hook Signaling

### To answer off-hook signaling (2nd call) and answer hold recall of 1st call:



- *Program 20-13-54 is set to Enable.*
- *Program 20-13-06 is set to Automatically*

1. From ext 100 call IP DECT 200 (1st call).
2. Answer on IP DECT 200 and talk with ext 100.
3. From ext 101 Call IP DECT (2nd call).
4. IP DECT receives off-hook signal.
5. Press the \* button on the IP DECT. Hold the 1st call and answer the 2nd call.
6. Talk with ext 101.
7. Use on-hook on the IP DECT to disconnect ext 101.
8. Hold Recall occurs and seizes the 1st call (On hold) on the IP DECT.
9. Talk with ext 100.

### To toggle between the 1st call and off-hook signaling (2nd call):



- *Program 20-13-54 is set to Enable.*
- *Program 20-13-06 is set to Automatically.*

1. From ext 100 call IP DECT 200 (1st call).
2. Answer on IP DECT 200 and talk with ext 100.
3. From ext 101 Call IP DECT (2nd call).
4. IP DECT receives off-hook signal.
5. Press the \* button on the IP DECT. Hold the 1st call and answer the 2nd call.
6. Talk with ext 101.
7. Press the \* button on the IP DECT. Hold the 2nd call and retrieve the 1st call (On hold).
8. Talk with ext 100.

### To answer off-hook signaling (2nd call) and 2nd caller disconnect the call:



- *Program 20-13-54 is set to Enable.*
- *Program 20-13-06 is set to Automatically*

1. From ext 100 call IP DECT 200 (1st call).
2. Answer on IP DECT 200 and talk with ext 100.
3. From ext 101 Call IP DECT (2nd call).
4. IP DECT receives off-hook signal.
5. Press the \* button on the IP DECT. Hold the 1st call and answer the 2nd call.
6. Talk with ext 101.
7. Use on-hook on ext 101. A busy tone is heard on the IP DECT.
8. Press the \* button on the IP DECT and retrieve the 1st call (On hold).
9. Talk with ext 100.

### Caller ID Display After a Call Transfer

#### To make screened transfer to IP DECT of trunk call:

Transferee : Caller ID:297XXXYYY  
 Transferrer : Multi line, Ext 100  
 Transfer target : IP DECT, Ext 200

1. Place a call to ext 100 from outside party 297XXXYYY.
2. Answer incoming call at ext 100 and press the **Transfer** button.
3. Dial 200 to call an IP DECT.
4. Announce the call and press the **Transfer** button or hang up ext 100.
5. Calling party number "297XXXYYY" is displayed on the IP DECT.

#### To make unscreened transfer to IP DECT of trunk call:

Transferee : Caller ID:297XXXYYY  
 Transferrer : Multi line, Ext 100  
 Transfer target : IP DECT, Ext 200

1. Place a call to ext 100 from outside party 297XXXYYY.
2. Answer incoming call at ext 100 and press the **Transfer** button.
3. Dial 200 to call an IP DECT.
4. Press the **Transfer** button or hang up ext 100.
5. The IP DECT rings and calling party number "297XXXYYY" is displayed on the IP DECT.

## SECTION 1 ABOUT THIS CHAPTER

The charts in this chapter provide a list of the Service Codes, Function Key Codes, and System Number Plan/Capacities. The service codes and function codes are listed by number and by feature in separate charts for ease of use.

## SECTION 2 SIMPLIFYING MULTILINE TERMINAL OPERATIONS WITH ONE-TOUCH KEY OPERATION

A multiline terminal user can access many features through Service Codes (e.g., Service Code **#9** to access a specific trunk). To streamline the operation of their telephone, a multiline terminal user can store these codes under One-Touch Keys. This provides one-button operation for almost any feature. To find out more, turn to the One-Touch Calling feature.

When reading an instruction using programmable keys, you will see a notation similar to (**PRG 15-07 or SC 7nn**). This means that the key requires function code nnn, and you can program this code through Program 15-07 or by dialing Service Code 751 or 752. Refer to the Programmable Function Keys feature for more information.

## SECTION 3 USING HANDSFREE

The manual assumes each extension has Automatic Handsfree. This lets a user just press a line key or Speaker Key to answer or place a call. For extensions without Automatic Handsfree, the user must:

- Lift the handset or press **Speaker** for intercom dial tone.
- Lift the handset or press **Speaker**, then press a line key for trunk dial tone.

Table 3-1 Post Dialing Service Codes – Single Digit Post Dialing Codes

Code	For this feature. . .	When you are. . .
1	Handsfree Answerback / Forced intercom Ringing	Changing the signaling mode of your outgoing Intercom call
2	Department Step Calling	Cycling to the next member of a Department Calling Group
3~5	Not used	
6	Voice Over	Sending a Voice Over to a busy extension after hearing Busy/Ring tone
7	Barge-In	Barge into another station's active call
8	Voice Mail	Leaving a message in a co-worker's mailbox after calling their busy or unanswered extension
0	Message Waiting	Leaving a Message Waiting at a co-worker's busy or unanswered extension
#	Call Waiting / Camp-On / Callback / Trunk Queuing	Call Waiting / Camp-On / Callback / Trunk Queuing
*	Off-Hook Signaling	Sending off-hook signal tones to a busy extension



Table 3-2 Service Codes by Number

Dial this Service Code. . . <sup>1</sup>	When you . . .	For this feature. . .	Also see Function Key. . .
* + Enter Account Code + *	Enter an Account Code.	Account Codes	-
**	Pick up a call ringing or waiting at another extension.	Directed Call Pickup Voice Response System (VRS)	-
*#	Pick up a call ringing an extension in your pickup group (except Ring Group calls).	Group Call Pickup	24
*0	Answer a Message Waiting request.	Message Waiting	38
*06	Set the Automatic Transfer for each trunk line.	Transfer	-
*07	Cancel the Automatic Transfer for each trunk line.	Transfer	-
*08	Set the Destination for Automatic Trunk Transfer.	Transfer	-
*1 + Paging Group Number	Make a Combined Page.	Paging	-
+ 0	Cancel Call Forwarding.	Call Forwarding	16
*2 + 1 + Type (2~4)	Activate Personal Answering Machine Emulation.	Voice Mail (Personal Answering Machine Emulation)	16
*2 + 2 + Destination + Type (2~4)	Activate Call Forwarding when Busy/Not Answered.	Call Forwarding	13
*2 + 3 + Destination + Type (2~4)	Activate Call Forward Follow Me at the destination extension.	Call Forwarding with Follow Me	15
*2 + 4 + Destination + Type (2~4)	Activate Call Forwarding Immediate.	Call Forwarding	10
*2 + 6 + Destination + Type (2~4)	Activate Call Forwarding when Unanswered (delayed).	Call Forwarding	12
*2 + 7 + Destination + Type (2~4)	Activate Call Forwarding (Both Ringing).	Call Forwarding	14
*3 (After + 001~400 + busy)	Disconnect a call in progress on a trunk.	Forced Trunk Disconnect	-
*4 + 3 + Message (01~20), or + 3 + Hang up to cancel	Activate or cancel Selectable Display Messaging.	Selectable Display Messaging	17

<sup>1</sup> Except where indicated, dial Service Code from Intercom dial tone (e.g., press idle Speaker first).

Table 3-2 Service Codes by Number (Continued)

Dial this Service Code. . . <sup>1</sup>	When you . . .	For this feature. . .	Also see Function Key. . .
*4 + 6 + Trunk access code + Outside number, or + 6 + Hold + Hang up to cancel	Forward your calls to an off-premise telephone number.	Call Forwarding Off-Premise	17
+ 7 + Record message + # + Condition (2, 4, 6 or 7) + Destination + Type (2 or 3) or + 7 + 3 to cancel	Record, listen to or erase a Personal Greeting or Park and Page.	Voice Response System (VRS) (Personal Greeting)	17
*5	Log out of or in to a group.	Contact Center	*10
*6 + Orbit (01~64)	Pick up a call parked in a system Park orbit (01~64).	Park	*04 + orbit
*8	Call your mailbox.	Voice Mail	77
#*#*	Enter system programming mode.	System Programming Password Protection	-
#*#9	Back up system data.	Maintenance	-
Hookflash + ## + Enter Account Code + Hookflash	Enter an Account Code at a single line telephone.	Account Codes	-
#0	Use Universal Answer Code to pick up a call ringing over the paging system.	Central Office Calls, Answering	-
Hookflash + #1 + extension + hookflash twice	Activate Conference from a Single Line (500/2500) Telephone.	Conference	-
#2 + bin	Dial a Common Speed Dialing number.	Speed Dialing	27
#3	Flash a trunk from an single line telephone.	Flash	-
#4 + bin	Dial a group Speed Dialing number.	Speed Dialing	28
#5	Use Last Number Redial.	Last Number Redial	-
*6 + orbit (01~64)	Park a call in a system Park orbit (1~8, 01~32 or 01~64).	Park	*04 + orbit (1~64)
#7	Use Personal Speed dialing.	Speed Dialing	-
#8	Set up an Unsupervised Conference.	Tandem Trunking (Unsupervised Conference)	-
#9 + 001 -400	Place a call over a specific trunk.	Central Office Calls, Placing	*01 + trunk (001~400)

<sup>1</sup> Except where indicated, dial Service Code from Intercom dial tone (e.g., press idle Speaker first).

Table 3-2 Service Codes by Number (Continued)

Dial this Service Code. . . <sup>1</sup>	When you . . .	For this feature. . .	Also see Function Key. . .
0 (Off-Hook)	Leave a Message Waiting at a co-worker's busy or unanswered extension.	Message Waiting	35
1 (Off-Hook)	Change the signaling mode of your outgoing Intercom call.	Handsfree Answerback/Forced Intercom Ringing	-
4 (On-Hook)	Listen to the General Message.	Voice Response System (VRS)	-
6 (On-Hook)	Check an extension number.	Voice Response System (VRS)	-
8 (On-Hook)	Listen for the time.	Voice Response System (VRS)	-
9	Place a call using ARS or Trunk Group Routing.	Automatic Route Selection Trunk Group Routing	*02
600 + code + 0	Use Dial Block.	Toll Restriction, Dial Block	-
601 + code + 0	Aa a supervisor use Dial Block.	Toll Restriction, Dial Block	-
602 + Group number (1~8 or 01~64)	Set Automatic Transfer Setup for each extension group.	Transfer	-
603 + Group number (1~8 or 01~64)	Cancel Automatic Transfer Setup.	Transfer	-
604 + Group number (1~8 or 01~64) + mode + extension	Set the destination for Automatic Transfer Setup for each extension group.	Transfer	-
605 + Group number (1~8 or 01~64)	Set Delayed Transfer for each extension group.	Transfer	-
606 + Group number (1~8 or 01~64)	Cancel Delayed Transfer.	Transfer	-
607 + Group number (1~8 or 01~64)	Set up DND for each extension group.	Transfer	-
608 + Group number (1~8 or 01~64)	Cancel DND for each extension group.	Transfer	-
611	Use an SLT to listen the General Message.	Voice Response System (VRS)	-
612 + 3 to erase, 5 to listen or 7 to record	Record, listen to or erase the General Message.	Voice Response System (VRS)	-

<sup>1</sup> Except where indicated, dial Service Code from Intercom dial tone (e.g., press idle Speaker first).

Table 3-2 Service Codes by Number (Continued)

Dial this Service Code. . . <sup>1</sup>	When you . . .	For this feature. . .	Also see Function Key. . .
616 + 3 to erase, 5 to listen or 7 to record	Record, listen to or erase a VRS Message.	Voice Response System (VRS)	-
618	Use Night Mode Switch for other group.	Night Answer	
620	Use Common Cancel Service Code.	TBD	-
621	Print the SMDR Extension Accumulated printout.	Station Message Detail Recording (SMDR)	-
622	Print the SMDR Group Accumulated printout.	Station Message Detail Recording (SMDR)	-
623	Print the SMDR Account Code Accumulated printout.	Station Message Detail Recording (SMDR)	-
782	Transfer a call to the VRS This can also be used for routing ANI/DNIS to the VRS.	Transfer	-
627	Enable DND at a room telephone.	Hotel/Motel (Do Not Disturb)	-
628	Cancel DND at a room telephone.	Hotel/Motel (Do Not Disturb)	-
629	Enable DND for another room telephone.	Hotel/Motel (Do Not Disturb)	-
630	Cancel DND at another room telephone.	Hotel/Motel (Wake Up Call)	-
631	Set up a Wake Up call for your own room telephone.	Hotel/Motel (Wake Up Call)	-
632	Cancel a Wake Up Call for your room telephone.	Hotel/Motel (Wake Up Call)	-
633	Set a Wake Up Call for another guest room telephone.	Hotel/Motel (Wake Up Call)	-
634	Cancel a Wake Up Call for another guest room telephone.	Hotel/Motel (Wake Up Call)	-
635	Enable Room to Room Call Restriction for a guest room telephone.	Hotel/Motel (Room to Room Call Restriction)	-
636	Disable Room to Room Call Restriction for a guest room telephone.	Hotel/Motel (Room to Room Call Restriction)	-

<sup>1</sup> Except where indicated, dial Service Code from Intercom dial tone (e.g., press idle Speaker first).

Table 3-2 Service Codes by Number (Continued)

Dial this Service Code. . . <sup>1</sup>	When you . . .	For this feature. . .	Also see Function Key. . .
<sup>1</sup> Except where indicated, dial Service Code from Intercom dial tone (e.g., press idle Speaker first).			
637	Change a room telephone Toll Restriction (When Checked In) level.	Hotel/Motel (Toll Restriction When Checked In)	-
638	Set a room as checked in.	Hotel/Motel (Room Status)	-
639	Set a room as checked out.	Hotel/Motel (Room Status)	-
641	Set a room status from another telephone.	Hotel/Motel (Room Status)	-
642	Request a Room Status Printout.	Hotel/Motel (Room Status Printouts)	-
645 + trunk # + 1 (block) 645 + trunk # + 0 (enable)	Block/busy out outbound usage on a trunk with Trunk Port Disable.	Central Office Calls, Placing	-
650 + 0 (install) or 1 (remove)	Log in (0) or log out (1) for your Department Calling Group.	Department Calling	
654	Enable Conversation Record at an SLT.	Voice Mail	-
655	Log out of or in to a Group from a single line telephone.	()	-
656	Activate Work Time from an SLT.	Automatic Call Distribution ()	*17
657	Cancel Work Time from an SLT.	Automatic Call Distribution ()	*17
658	Activate Rest Mode from an SLT.	Automatic Call Distribution ()	*13
659	Cancel Rest Mode from an SLT.	Automatic Call Distribution ()	*13
Hookflash + 160	Record for an SLT.	Automatic Call Distribution ()	-
663 + 6-digit code + line + telephone number	Override Toll Restriction.	Toll Restriction	-
667	Log an agent into their Group.	Automatic Call Distribution ()	-
668	Log an agent out of their Group.	Automatic Call Distribution ()	-
669	Are a supervisor assigning an agent into another Group or changing an agent's status.	Automatic Call Distribution ()	-

Table 3-2 Service Codes by Number (Continued)

Dial this Service Code. . . <sup>1</sup>	When you . . .	For this feature. . .	Also see Function Key. . .
670 + Group	Change your Group assignment.	Automatic Call Distribution ( )	-
672 + Line number (001~400)	Answer a call on a specific trunk.	Central Office Calls, Answering Hold	-
675	Monitor a room telephone.	Hotel/Motel (Room Monitor)	-
677	Change the COS of another extension. Must be allowed in Program 20-13-28.	Class of Service	-
678 + 0~9	Change the language of a display telephone.	Alphanumeric Display / Maintenance	-
679 + 1 (set) or 0 (cancel)	Change the ability for a second call with DID/DISA/DIL.	Central Office Calls, Answering	-
689	Transfer a Wireless DECT (SIP) call when out of range.	Wireless DECT (SIP)	-
700 + extension # + enter name + Hold	Program extension names.	Name Storing	55
701 + zone (1~9 or 01~64) 801 + zone (0 or 00)	Make an Internal Zone Page. Make an All Call Internal Page.	Paging, Internal	21 + zone 22
702 + Door Box (1~4 or 1~8)	Place a call to a Door Box.	Door Box	-
703 + zone (1~4 or 1~8) 803 + zone (0)	Make an External Zone page. Make an External All Call page.	External Paging	19 + zone 20
704 + trunk group (1~8 or 1~9 or 001~100)	Place an outside call over a trunk group.	Central Office Calls, Placing	*02 + group
707	Override Do Not Disturb or Call Forwarding.	Call Forwarding Do Not Disturb	37
708	Step through a Department Group.	Department Step Calling	36
709	Send a Call Waiting tone to a busy extension.	Call Waiting	33
710	Break into another extension call.	Barge-In	-
711 + 1 (ICM) or 2 (TRK) + tone (1~8)	Listen to the incoming ring choices.	Selectable Ring Tones	-
712	Change the signal type for calling an extension.	Intercom	-

<sup>1</sup> Except where indicated, dial Service Code from Intercom dial tone (e.g., press idle Speaker first).

Table 3-2 Service Codes by Number (Continued)

Dial this Service Code. . . <sup>1</sup>	When you . . .	For this feature. . .	Also see Function Key. . .
715	Save a number (from SLT) or dial a saved number	Save Number Dialed	30
718 + 1 718 + 2 718 + 3 718 + 4 718 + 5 718 + 6 718 + 7 718 + 8	Activate Day 1 Mode. Activate Night 1 Mode. Activate Midnight 1 Mode. Activate Rest 1 Mode. Activate Day 2 Mode. Activate Night 2 Mode. Activate Midnight 2 Mode. Activate Rest 2 Mode.	Night Service	09 + 1 09 + 2 09 + 3 09 + 4 09 + 5 09 + 6 09 + 7 09 + 8
720 + 1 (ICM) or 2 (TRK) + tone (1~8)	Change your extension incoming ring tones.	Selectable Ring Tones	-
721	Enable Handsfree Answerback for incoming Intercom calls.	Handsfree Answerback/Forced Intercom Ringing	-
722	Call off-premise with a Door Box.	Call Forwarding, Off-Premise Door Box	54
723	Enable Forced Ringing for incoming Intercom calls.	Handsfree Answerback/Forced Intercom ringing	-
724	Enable/disable Dial Pad Confirmation Tone.	Dialing Pad Confirmation tone	-
725	Turn Background Music on and off.	Background Music	04
727 + 1 or 2 + time, or 727 + 1 or 2 + 9999 to cancel	Check, set or cancel an alarm.	Alarm	-
728 + hour + minutes	Set the system Time.	Time and Date Clock/Calendar Display	-
729	Check or change ring volume.	Volume Control	-
730	Use Remote maintenance.	-	-
732	Place a call on Group Hold.	Hold	-
740	Access the internal modem on the GCD-CP10.	-	-
747 + 0 (Cancel) 1 (Trk calls) 2 (Paging, ICM, Call Forward and transfers) 3 (All calls) 4 (Call Forwards)	Activate Do Not Disturb.	Do Not Disturb	03

<sup>1</sup> Except where indicated, dial Service Code from Intercom dial tone (e.g., press idle Speaker first).

Table 3-2 Service Codes by Number (Continued)

Dial this Service Code. . . <sup>1</sup>	When you . . .	For this feature. . .	Also see Function Key. . .
749	Place a call on Exclusive Hold at an SLT.	Hold	-
750	Camp On to an extension when calling into the system through the VRS.	Voice Response System (VRS)	35
751 + key + code	Change the function of a programmable key using 751 service code.	Programmable Function Keys	-
752 + key + code	Change the function of a programmable key using 752 service code.	One-Touch Serial Operation	-
753 + bin + number + Hold + Name + Hold to store	Store Common Abbreviated Dialing numbers.	Abbreviated Dialing	-
754 + bin + number + Hold + Name + Hold to store	Store Group Abbreviated Dialing numbers.	Abbreviated Dialing	-
755 + One Touch key + code	Program a One-Touch Key or Personal Speed Dial.	One-Touch Dialing	-
756	Answer a call ringing a telephone in your pickup group (except Ring Group calls).	Group Call Pickup	-
757	Park a call or pick up a parked call at an extension.	Park	-
759	Retrieve a call from Exclusive Hold at an SLT.	Hold	-
760	Use DID Access Code.	Automatic Call Distribution ( )	-
762	Pick up a call from Group Hold.	Hold	-
763	Join a Meet Me Conference or Meet Me Page on an Internal Paging Zone (if your extension is in the group called).	Meet Me Conference Meet Me Paging	23 or 32
764 + zone paged (0~9 or 00~64)	Join a Meet Me Conference or Meet Me Page if your extension is not in the group paged.	Meet Me Paging	23 or 32
765 + zone (0~8)	Join a Meet Me Conference or Meet Me Page on an External Paging Zone.	Meet Me Conference Meet Me Paging	23 or 32

<sup>1</sup> Except where indicated, dial Service Code from Intercom dial tone (e.g., press idle Speaker first).



Table 3-2 Service Codes by Number (Continued)

Dial this Service Code. . . <sup>1</sup>	When you . . .	For this feature. . .	Also see Function Key. . .
768 + pickup group (1~8 or 1~9 or 01~64)	Answer a call ringing a telephone in another pickup group (except Ring Group calls).	Group Call Pickup	26 + group
769	Answer a call ringing a telephone in another pickup group if you do not know the group number (except Ring Group Calls).	Group Call Pickup	25
770	Cancel a Callback request.	Callback	-
771 + ext	Cancel Messages Waiting you left at a specific extension.	Message Waiting	-
773	Cancel all Messages Waiting you have left at other extensions.	Message Waiting	-
775 + pswd (0000) + place outside call	Temporarily override an extension Toll Restriction.	Toll Restriction Override	-
776	Clear number saved by Last Number Redial.	Last Number Redial	-
780 + Relay (0~8)	Use the General Purpose Relay.	Paging, External Night Service	51
781 + 00 (no tone), 01 (general) or 02 (holiday)	Change the Music on Hold Tone.	Music on Hold	-
782	Route ANI/DNIS to the VRS. It can also be used to transfer to VRS.	Transfer Voice Response Service (VRS)	-
783	Enable the data communication auto-answer mode.	Data Communications	-
784	Access the VRS.	Voice Response Service (VRS)	-
785	Clear the number saved by Save Number Redial.	Save Number Redial	-
790	Use Voice Over after calling a busy extension.	Voice Over	48
794	Split between two calls on an SLT.	Call Waiting	-
799	Test Callback operation for an SLT.	Callback	-

<sup>1</sup> Except where indicated, dial Service Code from Intercom dial tone (e.g., press idle Speaker first).

Table 3-3 Service Codes by Feature

For this feature...	Dial this Service Code... <sup>1</sup>	When you ...	Also see Function Key...
Speed Dialing	753 + bin + number + Hold + Name + Hold to store	Store System Speed Dialing numbers.	-
	754 + bin + number + Hold + Name + Hold to store	Store Group Speed Dialing numbers.	-
	#2 + bin	Dial a System Speed Dialing number.	27
	#4 + bin	Dial a Group Speed Dialing number.	28
	#7 + bin	Use Personal Speed Dialing.	-
Account Codes	* + Enter Account code + *	Enter an Account Code.	-
	Hookflash + ## + Enter account code + Hookflash	Enter an Account Code at an SLT.	-
Alarm	727 + 1 or 2 + time, or 727 + 1 or 2 + 9999 to cancel	Check, set or cancel an alarm.	-
Alphanumeric Display	678 + 0~9	Select the language used on display multiline terminals.	-
Wireless DECT (SIP)	689	Transfer a Wireless DECT (SIP) call when out of range.	-
Automatic Call Distribution ()	*5	Log out of or in to a Group.	*10
	655	Log out of or in to a Group from an SLT.	
	656	Activate Work Time from an SLT.	*17
	657	Cancel Work Time from an SLT.	*17
	658	Activate Rest Mode from an SLT.	*13
	659	Cancel Rest Mode from an SLT.	*13
	Hookflash + 660	Use Recording with an SLT.	-
	667	Allow a Agent to log into a group.	-
	668	Allow a Agent to log out of a group.	-
	669	Allow a supervisor to change agent's status.	-
	670 + Group	Change your Group assignment.	-
Automatic Route Selection or Trunk Group Routing	9	Place a call using Trunk Group. Route an Automatic Route Selection.	*02
Background Music	725	Turn Background Music on or off.	04

<sup>1</sup> Except where indicated, dial Service Code from intercom dial tone (e.g., press idle Speaker first).

Table 3-3 Service Codes by Feature (Continued)

For this feature...	Dial this Service Code... <sup>1</sup>	When you ...	Also see Function Key...
Call Forwarding	745	Set/Cancel Call Forwarding (Both Ringing).	14
	742	Set/Cancel Call Forwarding when Busy.	11
	744	Set/Cancel Call Forwarding when Busy/ No Answer.	13
	743	Set/Cancel Call Forwarding No Answer.	12
	746	Set/Cancel Call Forwarding Follow Me.	15
	741	Set/Cancel Call Forwarding Immediate.	10
Call Forwarding, Off-Premise Door Box	722	Call off-premise with a Door Box.	54
Call Forwarding/Do Not Disturb Override	707	Override an extension Call Forward or DND setting.	37
Call Waiting / Camp-On	794	Split (switch) between calls on an SLT.	-
	770	Cancel a Callback request.	-
	799	Test Callback operation for an SLT.	-
Callback / Camp-On / Trunk Queuing	#	Camp On or leave a Callback for a busy extension or trunk.	35
	770	Cancel a Callback request.	-
	799	Test Callback operation for an SLT.	-
Central Office Calls, Answering / Hold	#0	Use Universal Answer to pick up a call ringing over the paging system.	-
	672 + Line number (001~400)	Answer a call on a specific trunk.	-
	679 + 1 (set) or 0 (cancel)	Change the ability for a second call with DID/DISA/DIL.	-
Central Office Calls, Placing	#9 + 001~400	Place a call over a specific trunk.	*01 + trunk (001-400)
	645 + trunk # + 1 (block) 145 + trunk # + 0 (enable)	Block/busy out outbound usage on a trunk with Trunk Port Disable.	-
	704 + trunk group (1~9 or 001~100)	Place an outside call over a trunk group.	*02 + group
Class of Service	677	Change the COS of another extension. Must be allowed in Program 20-13-28.	-

<sup>1</sup> Except where indicated, dial Service Code from intercom dial tone (e.g., press idle Speaker first).

Table 3-3 Service Codes by Feature (Continued)

For this feature...	Dial this Service Code... <sup>1</sup>	When you ...	Also see Function Key...
Conference	Hookflash + #1 + extension + hookflash twice	Activate Conference from a Single Line (500/2500) Telephone.	07
Data Communications	783	Enable the data connection auto-answer mode.	-
	784	Disconnect an active data call.	-
Department Calling	650 + 0 (install) or 1 (remove)	Log in (0) or log out (1) for your Department Calling Group.	46
Department Step Calling	#	Step Call through a Department Group.	36
Dial Pad Confirmation Tone	724	Enable/disable Dial Pad Confirmation Tone.	-
Directed Call Pickup	** + ext.	Pick up a call ringing or waiting at an extension.	-
Do Not Disturb	747 + 0 (Cancel) 1 (Trk calls) 2 (Paging, ICM, Call Forwards, and Transfers) 3 (All calls) 4 (Call Forwards)	Activate Do Not Disturb.	03
Door Box	702 + Door Box (1~4 or 1~8)	Place a call to a door Box.	-
	722	Forward a Door Box off-premise.	-
E911	786	Turn off the E911 alarm.	-
Flash	#3	Flash a trunk from an SLT.	-
Forced Trunk Disconnect	* 3 (after #9 + 1~8 or 001~400 + busy)	Disconnect a call in progress on a trunk.	-
Group Call Pickup	756	Pick up a call ringing an extension in your own pickup group (except Ring Group calls).	24
	768 + pickup group (1~8 or 1~9 or 01~64)	Answer a call ringing a telephone in another pickup group.	26 + group
	769	Answer a call ringing a telephone in another pickup group if you do not know the group number (except Ring Group calls).	25

<sup>1</sup> Except where indicated, dial Service Code from intercom dial tone (e.g., press idle Speaker first).

Table 3-3 Service Codes by Feature (Continued)

For this feature...	Dial this Service Code... <sup>1</sup>	When you ...	Also see Function Key...
Handsfree Answerback/Forced Intercom Ringing	1 (Off-Hook)	Change the signaling mode of your outgoing Intercom call.	-
	721	Enable Handsfree Answerback for incoming Intercom calls.	-
	723	Enable Forced Ringing for incoming Intercom calls.	-
Hold	732	Placing a call on Group Hold.	-
	749	Place a call on Exclusive Hold at an SLT.	-
	759	Retrieve a call from Exclusive Hold at a 2-Button telephone.	-
	762	Pick up a call from Group Hold.	-
Hotel/Motel (Do Not Disturb)	627	Enable DND at a room telephone.	-
Hotel/Motel (Do Not Disturb)	628	Cancel DND at a room telephone.	-
Hotel/Motel (Do Not Disturb)	629	Enable DND for another room telephone.	-
Hotel/Motel (Do Not disturb)	630	Cancel DND at another room telephone.	-
Hotel/Motel	675	Monitor a room telephone.	-
Hotel/Motel (Wake Up Call)	631	Set a Wake Up Call for your room telephone.	-
Hotel/Motel (Wake Up Call)	632	Cancel a Wake Up Call for your room telephone.	-
Hotel/Motel (Wake Up Call)	633	Set a Wake Up Call for another guest room telephone.	-
Hotel/Motel (Wake Up Call)	634	Cancel a wake Up Call for another guest room telephone.	-
Hotel/Motel (Room to Room Call Restriction)	635	Enable Room to Room Call Restriction for a guest room telephone.	-
Hotel/Motel (Room to Room Call Restriction)	636	Disable Room to Room Call Restriction for a guest room	-
Hotel/Motel (Toll restriction [When Checked In])	637	Change a room telephone Toll Restriction (When Checked In) level.	-

<sup>1</sup> Except where indicated, dial Service Code from intercom dial tone (e.g., press idle Speaker first).

Table 3-3 Service Codes by Feature (Continued)

For this feature...	Dial this Service Code... <sup>1</sup>	When you ...	Also see Function Key...
Hotel/Motel (Room Status)	638	Set a room as checked in.	-
Hotel/Motel (Room Status)	639	Set room as checked out.	-
Hotel/Motel (Room Status)	641	Set a room as available (clean) from another telephone.	-
Hotel/Motel (Room Status Printouts)	642	Request a Room Status Printout.	-
Last Number Redial	#5	Use Last Number Redial.	-
	776	Clear number saved by Last Number Redial.	-
Maintenance	# * # 9	Back up system data.	-
	678 + 0~9	Display the language the telephone is using.	-
Meet Me Conference Meet Me Paging	763	Join a Meet Me Conference or Meet Me Page on an Internal Paging Zone (if your extension is in the group called).	23 (Meet Me Paging) or 32 (Meet Me Conference)
	764 + zone paged (0~9 or 00~64)	Join a Meet Me Conference or Meet Me Page if your extension is not in the group paged.	-
	765 + zone (0~8)	Join a Meet Me conference or Meet Me Page on an External Paging Zone.	-
Message Waiting	0 (Off-Hook)	Leave a Message Waiting at a co-worker's busy or unanswered extension.	38
	*0	Answer a Message Waiting request.	38
	771 + ext	Cancel Messages Waiting you have left at a specific extension.	-
	773	Cancel all Messages Waiting you have left at other extensions.	-
Music on Hold	781 + 00 (no tone), 01 (general) or 02 (holiday)	Change the Music on Hold Tone.	-
Name Storing	700 + enter name + Hold	Program extension names.	55

<sup>1</sup> Except where indicated, dial Service Code from intercom dial tone (e.g., press idle Speaker first).

Table 3-3 Service Codes by Feature (Continued)

For this feature...	Dial this Service Code... <sup>1</sup>	When you ...	Also see Function Key...
Night Service	618	Use Night Mode Switching for other group.	-
	718 + 1 718 + 2 718 + 3 718 + 4 718 + 5 718 + 6 718 + 7 718 + 8	Activate Day 1 Mode. Activate Night 1 Mode. Activate Midnight 1 Mode. Activate Rest 1 Mode. Activate Day 2 Mode. Activate Night 2 Mode. Activate Midnight 2 Mode. Activate Rest 2 Mode.	09 + 1 09 + 2 09 + 3 09 + 4 09 + 5 09 + 6 09 + 7 09 + 8
Off-Hook Signaling	* (Off-Hook) or 709	Send off-hook signal tones to a busy extension.	33
One-Touch Dialing	755 + One-Touch key + code	Program a One-Touch Key or Personal Speed Dial.	-
Paging, Combined	*1 + Zone (1~8) *1 + Zone (0)	Make a combined zone page. Make a combined All Call page.	19 + zone 20
Paging, External	703 + zone (1~8) 703 + zone (0)	Make an external zone page. Make an external All Call page.	19 + zone 20
Paging, External Night Service	780 + relay number (0~8)	Activate the general purpose relay.	51
Paging, Internal	701 + zone (1~8, 1~9 or 01~64) 701 + zone (0 or 00)	Make an Internal Zone Page. Make an internal All Call Page.	21 + zone or 22
Park	#6 + orbit (01~64)	Park a call in a system Park orbit (01~64).	*04 + orbit
	*6 + orbit (01~64)	Pick up a call parked in a system Park orbit (01~64).	*04 + orbit
	757	Park a call or pick up a parked call at an extension.	-
Programmable Function Keys	751 + key + code	Change the function of a programmable key using 751 service code.	-
	752 + key + code	Change the function of a programmable key using 752 service codes.	-
Save Number Dialed	715	Save a number (from SLT) or dial a saved number.	30
	785	Clear the number saved by Save Number Redial number.	-

<sup>1</sup> Except where indicated, dial Service Code from intercom dial tone (e.g., press idle Speaker first).

Table 3-3 Service Codes by Feature (Continued)

For this feature...	Dial this Service Code... <sup>1</sup>	When you ...	Also see Function Key...
Selectable Display Messaging	*4 + 3 + message (01~20), or *4 + 3 + Hang up to cancel	Activate or Cancel Selectable Display Messaging.	17
Selectable Ring Tones	711 + 1 (ICM) or 2 (Trk) + tone (1~8)	Listen to the incoming ring choices.	-
	720 + 1 (ICM) + 2 (Trk) + tone (1~8)	Change your extension incoming ring tones.	-
System Programming Password Protection	# * # *	Enter system programming mode.	-
Station Message Detail Recording	621	Print the SMDR Extension Accumulated printout.	-
	622	Print the SMDR Group Accumulated printout.	-
	623	Print the SMDR Account Code Accumulated printout.	-
Tandem Trunking (Unsupervised Conference)	#8	Set up an Unsupervised Conference.	06
Time and Date Clock/Calendar Display	728 + hour + minutes	Set the system Time.	-
Toll Restriction, Dial Block	600 + code + 0	Use Dial Block.	-
	601 + code + 0	As a supervisor use Dial Block.	-
Toll Restriction Override	775 + pswd (0000) + place outside call	Temporarily override an extension Toll Restriction.	-
	663 + digit code + line + telephone number	Override Toll Restriction.	-

<sup>1</sup> Except where indicated, dial Service Code from intercom dial tone (e.g., press idle Speaker first).



Table 3-3 Service Codes by Feature (Continued)

For this feature...	Dial this Service Code... <sup>1</sup>	When you ...	Also see Function Key...
Transfer	733	Set the Automatic Transfer for each trunk line.	-
	734	Cancel the Automatic Transfer for each trunk line.	-
	735	Set the Destination for Automatic Trunk Transfer.	-
	602 + Group number (1~8 or 01~64)	Set Automatic Transfer Setup for each extension group.	-
	603+ Group number (1~8 or 01~64)	Cancel Automatic Transfer Setup	-
	604 + Group number (1~8 or 01~64) + mode + extension	Set the destination for Automatic Transfer Setup for each extension group.	-
	605 + Group number (1~8 or 01~64)	Set Delayed Transfer for each extension group.	-
Transfer (continued)	606 + Group number (1~8 or 01~64)	Cancel Delayed Transfer.	-
	607 + Group number (1~8 or 01~64)	Set up DND for each extension group.	-
	608 + Group number (1~8 or 01~64)	Cancel DND for each extension group.	-
	624 + Extension number	Transfer a call into an existing call.	-
	782	Transfer a call to the VRS. This can be used also to route ANI/DNIS to the VRS.	-
Trunk Group Routing or Automatic Route Selection	9	Place a call using Trunk Group Routing or Automatic Route Selection.	*02
Trunk Queuing	*8	Call your mailbox.	67
	654	Enable Conversation Record at an SLT.	-
	# (Off-Hook)	Camp on to or leave a Callback at a busy trunk.	35
Voice Mail	8 (Off-Hook)	Leave a message in a co-worker's mailbox after callback their busy or unanswered extension.	-
	*8	Call your mailbox.	77
	654	Enable Conversation Record at an SLT.	-

<sup>1</sup> Except where indicated, dial Service Code from intercom dial tone (e.g., press idle Speaker first).

Table 3-3 Service Codes by Feature (Continued)

For this feature...	Dial this Service Code... <sup>1</sup>	When you ...	Also see Function Key...
Voice Over	6 (Off-Hook)	Send a Voice Over to a busy extension after hearing Busy/Ring tone.	48
Voice Response System (VRS)	** + ringing ext.	Pick up a call ringing another extension for Directed Call Pickup or VRS Park and Page.	-
	616 + 7 + Record message + # + Condition (2, 4,6 or 7) + Destination + Type (2 or 3) or 616 + 7 + 3 to cancel	Record, listen to or erase a Personal Greeting or Park and Page.	17
	4 (On-Hook)	Listen to the General Message.	-
	6 (On-Hook)	Check an extension number.	-
	8 (On-Hook)	Listen for the time.	-
	611	Use SLT to listen to the General Message.	-
	612 + 3 to erase, 5 to listen or 7 to record	Record, listen to or erase the General Message.	-
	616 + 3 to erase, 5 to listen or 7 to record	Record, listen to or erase a VRS Message.	-
	750	Camp On to an extension when calling into the system through the VRS.	-
	782	Transfer a call to the VRS. This can be used also to route ANI/DNIS to the VRS.	-
	784	Access the VRS.	-
Volume Control	729	Check or change ring volume.	-
Common Canceling Service Code	620	Use Common Canceling Service Code.	-

<sup>1</sup> Except where indicated, dial Service Code from intercom dial tone (e.g., press idle Speaker first).

Table 3-4 Function Key Codes by Feature

To program a key, press Speaker, dial 751 (for 2-digit codes) or 752 (for 3-digit codes), press the key and enter the code (e.g., 48 for Voice Over).

For this feature...	Use this key...	When you ...	Key Lamp Status	Also See Svc Code
Speed Dialing	<b>Code:</b> 27 <b>Operation:</b> Press key + bin + Line or Speaker key	Dial a stored System Speed Dialing number.	None	#2 + bin
	<b>Code:</b> 28 <b>Operation:</b> Press key + bin + Line or Speaker key	Dial a stored Group Speed Dialing number.	None	# 4 + bin
Account Codes	<b>Code:</b> 50 <b>Operation:</b> Press key + Dial Account Code	Enter Account Codes.	None	*
Automatic Call Distribution ( )	<b>Code:</b> *10 <b>Operation:</b> Press key to log in Press key + 1 to log out or 0 to cancel	Basic Operation Log in or out of a Group.	On red when logged in Off when logged out	-
	<b>Code:</b> *12 <b>Operation:</b> Press key	Emergency Call Place or receive an Emergency Call.	On while calling your supervisor or after being answered by your supervisor Flashing fast at the supervisor while ringing	-
	<b>Code:</b> *13 <b>Operation:</b> Press key	Rest Mode Enable/disable Rest Mode.	On red when Rest Mode enabled Off when Rest Mode disabled	-
	<b>Code:</b> *14 <b>Operation:</b> Press key + Press 1 (Yes) or 2 (No)	Out of Service Take a Group out of Service (for Group Supervisors only), or Take all Groups out of service (for System Supervisors only).	On red when the group is out of service.	-
	<b>Code:</b> *15 <b>Operation:</b> Call busy agent + Press key	Terminal Monitor Monitor a Agent's conversation.	On red while monitoring Off when not monitoring	-

Table 3-4 Function Key Codes by Feature (Continued)

To program a key, press Speaker, dial 751 (for 2-digit codes) or 752 (for 3-digit codes), press the key and enter the code (e.g., 48 for Voice Over).

For this feature...	Use this key...	When you ...	Key Lamp Status	Also See Svc Code
Automatic Call Distribution () (cont.)	<b>Code: *16</b> <b>Operation:</b> Press key to put agent on hold. Press key again + 1 to hang up agent or 0 to bring agent back into call.	Switch (split) between a Agent and their outside caller after answering an emergency call.	On red while the agent is on hold	-
	<b>Code: *17</b> <b>Operation:</b> Press key	Working Time Enable/disable Work Time.	On when Work Time enabled, Flashing while on a call if Auto Work Time enabled Off when Work Time disabled	-
	<b>Code: *18 + Group</b> <b>Operation:</b> Press key	Overflow Control Overflow calls to another group.	On when enabled, Slow flash when disabled	-
	<b>Code: *19</b> <b>Operation:</b> Press key while on-hook + Vol Up or Vol Down to scroll	Queue Status Check When in a group, check the status of the queue groups.	None	-
Background Music	<b>Code: 04</b> <b>Operation:</b> Press key	Turn Background Music on or off.	None	725
Barge-In	<b>Code: 34</b> <b>Operation:</b> Call ext + Press key	Barge-In on a co-worker's conversation.	None	710
Call Arrival (CAR) Key	<b>Code: *03 + ext.</b> <b>Operation:</b> Press key	Place or answer a call to your co-worker's extension.	Slow Flash red when ringing, On red when busy	-
Call Forwarding, Both Ring	<b>Code: 14</b> <b>Operation:</b> Press key + Dest. Extension	Call Forward Both Ring to extension.	Slowly flashes red	745
Call Forwarding, Busy	<b>Code: 11</b> <b>Operation:</b> Press key + Dest. Extension	Call Forward Busy to extension or Voice Mail.	Slowly flashes red	742
Call Forwarding, Busy/No Answer	<b>Code: 13</b> <b>Operation:</b> Press key + Dest. Extension	Call Forward Busy/No Answer to extension or Voice Mail.	Slowly flashes red	744
Call Forwarding, External by Door Box	<b>Code: 54</b> <b>Operation:</b> Press key + Dest. Number	Externally Call Forward Door Box calls.	Slowly flashes red	722

Table 3-4 Function Key Codes by Feature (Continued)

To program a key, press Speaker, dial 751 (for 2-digit codes) or 752 (for 3-digit codes), press the key and enter the code (e.g., 48 for Voice Over).

For this feature...	Use this key...	When you ...	Key Lamp Status	Also See Svc Code
Call Forwarding, Follow Me	<b>Code:</b> 15 <b>Operation:</b> Press key + Dest. Extension	Call Forward Follow Me to extension or Voice Mail.	Slowly flashes red	746
Call Forwarding, Immediate	<b>Code:</b> 10 <b>Operation:</b> Press key + Dest. Extension	Call Forward Immediate to extension or Voice Mail.	Slowly flashes red	741
Call Forwarding, No Answer	<b>Code:</b> 12 <b>Operation:</b> Press key + Dest. Extension	Call Forward No Answer to extension or Voice Mail.	Slowly flashes red	743
Call Forwarding / Do Not Disturb Override	<b>Code:</b> 37 <b>Operation:</b> Call extension + Press key	Override an extension Call Forwarding or Do Not Disturb.	None	707
Callback / Camp-On/ Trunk Queuing	<b>Code:</b> 35 <b>Operation:</b> Call busy extension or access busy trunk + Press key	Leave a Call back request at a busy extension, Camp On to a busy extension, or Queue for a busy trunk.	On red when activated	#
Call Redirect	<b>Code:</b> 49 + extension or voice mail <b>Operation:</b> Press key	Redirect a ringing call to the predefined destination.	On red when activated	-
Central Office Calls	<b>Code:</b> *01 + Trunk number (001~400) <b>Operation:</b> Press key	Press a line key to place or answer a trunk call (where trunks are 001~400).	On green when seized, on red when in use (by other party), Slow Flash green when ringing, Hold flash when on Hold	#9
Conference	<b>Code:</b> 07 <b>Operation:</b> Set up call + Press key + set up call to add + Press key twice	Set up a Conference or a Meet Me Conference.	On red during setup	#1
Department Calling	<b>Code:</b> 46 <b>Operation:</b> Press Key	Log in or log out of your Department Calling Group.	On when removed, Off when installed	650
Department Step Calling	<b>Code:</b> 36 <b>Operation:</b> Dial busy ext + Press key	Step Call through a Department Group for an idle member.	None	2
Direct Station Selection / One-Touch Calling	<b>Code:</b> 01 <b>Operation:</b> Press key + dest. ext. or outside tel. # + Hold	Call an extension or outside number using a DSS key.	Off = extension idle On = extension busy Flashing = DND	-

Table 3-4 Function Key Codes by Feature (Continued)

To program a key, press Speaker, dial 751 (for 2-digit codes) or 752 (for 3-digit codes), press the key and enter the code (e.g., 48 for Voice Over).

For this feature...	Use this key...	When you ...	Key Lamp Status	Also See Svc Code
Do Not Disturb	<b>Code:</b> 03 <b>Operation:</b> Press key + code (0~4)	Set your telephone in DND.	DND key on red	747
Do Not Disturb/Call Forward Override	<b>Code:</b> 37 <b>Operation:</b> Press key	Call an extension which is in DND or Call Forwarded.	None	707
General Purpose Relay	<b>Code:</b> 51 + relay number <b>Operation:</b> Press key	Activate the general purpose relay.	On when active	780
Group Call Pickup	<b>Code:</b> 24 <b>Operation:</b> Speaker key + Press key	Answer a call ringing another telephone in your Pickup Group.	None	**#
	<b>Code:</b> 25 <b>Operation:</b> Speaker key + Press key	Answer a call ringing a telephone in another Pickup Group – if you do not know the group number.	None	769
	<b>Code:</b> 26 + Pickup Group (1~8 or 1~9 or 01~64) <b>Operation:</b> Speaker key + Press key + Pkup Group	Answer a call ringing a telephone in a specific Pickup Group.	None	768
Handset Cutoff	<b>Code:</b> 40 <b>Operation:</b> Press key	Cut off the handset transmission while on a call.	On when feature active (no transmission on handset)	-
Hotline	<b>Code:</b> 01 + dest. ext <b>Operation:</b> Press key	Place a call to your Hotline partner.	Full BLF (red) for covered ext.	-
Headset Operation	<b>Code:</b> 05 <b>Operation:</b> Press key	Enable or disable Headset Operation.	On red when activated	688
Hold	<b>Code:</b> 44 <b>Operation:</b> Place or answer call + Press key	Put a call on System Hold (if your telephone Hold key is reassigned).	None	-
	<b>Code:</b> 45 <b>Operation:</b> Place or answer call + Press key	Put a call on Exclusive Hold.	None	-
Meet Me Conference (Also see Conference)	<b>Code:</b> 32 <b>Operation:</b> Press key	Join a Meet Me Conference.	None	763 or 764

Table 3-4 Function Key Codes by Feature (Continued)

To program a key, press Speaker, dial 751 (for 2-digit codes) or 752 (for 3-digit codes), press the key and enter the code (e.g., 48 for Voice Over).

For this feature...	Use this key...	When you ...	Key Lamp Status	Also See Svc Code
Memo Dial	<p><b>Code:</b> 31</p> <p><b>Operation:</b>  <u>Store:</u> While on call, press key + number to store  <u>Use:</u> Press Key + Call or line  <u>Erase:</u> Speaker key + Press key</p>	Store, use or check a Memo dial number.	None	-
Message Waiting	<p><b>Code:</b> 38</p> <p><b>Operation:</b> Leave message: Call ext + Press key OR Answer message: Press key</p>	Answer/Leave a Message Waiting.	None	*0
Microphone Cutoff	<p><b>Code:</b> 02</p> <p><b>Operation:</b> Set up call + Press key</p>	Use Microphone Cutoff.	On red when activated	-
Call Arrival (CAR) Keys	<p><b>Code:</b> *03 + ext. or dept group</p> <p><b>Operation:</b> Press key</p>	Place or answer a call to your virtual (phantom) extension.	Slow Flash red when ringing, On red when busy	-
Name Storing	<p><b>Code:</b> 55</p> <p><b>Operation:</b> Press key + ext ## + name + Hold</p>	Enter a name for the extension to be displayed on telephones.	None	700
Networking	<p><b>Code:</b> *06 + network (01~50)</p> <p><b>Operation:</b> Press key</p>	Access a networked trunk.	None	-
Night Service	<p><b>Code:</b> 09 + mode (1~4 or 1~8)</p> <p><b>Operation:</b> Press key</p>	Activate the Day/Night Mode.	On red when activated	718 + 0
Off-Hook Signaling	<p><b>Code:</b> 33</p> <p><b>Operation:</b> Call ext. and receive busy + Press key</p>	Signal a busy extension.	None	7
Paging, External	<p><b>Code:</b> 19 + zone (1~8)</p> <p><b>Operation:</b> Press Key</p>	Make an external zone page.	On red when activated	703 + zone
	<p><b>Code:</b> 20</p> <p><b>Operation:</b> Press key</p>	Make an external All Call page.	On red when activated	703 + 0

Table 3-4 Function Key Codes by Feature (Continued)

To program a key, press Speaker, dial 751 (for 2-digit codes) or 752 (for 3-digit codes), press the key and enter the code (e.g., 48 for Voice Over).

For this feature...	Use this key...	When you ...	Key Lamp Status	Also See Svc Code
Paging, Internal	<b>Code:</b> 21 + zone (1~8, 1~9 or 01~64) <b>Operation:</b> Press key	Broadcast to an Internal Paging Zone.	On red when activated	701 + zone
	<b>Code:</b> 2 <b>Operation:</b> Press key	Broadcast to all Internal Paging zones.	On red when activated	701 + 0 or 00
Park	<b>Code:</b> *04 + orbit (1~9 or 01~64) <b>Operation:</b> Place or answer call + Press key	Place a call into or retrieve a call from a Park Orbit.	Fast flash when orbit is busy (green at originator, red at others)	#6 (Park) *6 (pickup)
Repeat Redial	<b>Code:</b> 29 <b>Operation:</b> Place call and press key	Activate Repeat Redial while on a call.	Fast Flash while system waits to redial	-
Reverse Voice Over	<b>Code:</b> 47 + dest. ext. <b>Operation:</b> Press and hold key	Initiate Reverse Voice Over.	Full BLF red	-
Room Monitor	<b>Code:</b> 39 <b>Operation:</b> Press key at destination & source + ext	Activate Room Monitor.	Dest. Fast Flash red, Source Hold Flash red	-
Save Number Dialed	<b>Code:</b> 30 <b>Operation:</b> <u>Save:</u> Place call + Press key <u>Redial:</u> Line or Speaker key + Press key	Save, redial or check saved number.	None	-
Secretary Call (Buzzer)	<b>Code:</b> 41 + sec. ext <b>Operation:</b> Press key	Call your secretary (using the buzzer).	On red at source Fast Flash red at destination	-
Secretary Call Pickup	<b>Code:</b> 42 + boss ext <b>Operation:</b> Press key	As a secretary pick up a call ringing your boss's extension.	On red when activated	-
Selectable Display Messaging	<b>Code:</b> 18 <b>Operation:</b> Press key + additional data if needed	Set up Call Forwarding Off-Premise, Selectable Display Messaging, VRS Park and Page and VRS Personal Greeting.	Flashes red when activated	-
Serial Call	<b>Code:</b> 43 <b>Operation:</b> Trk call + Hold + ext + Press key	Place a Serial Call to a co-worker.	None	-
Step Call	<b>Code:</b> 36 <b>Operation:</b> Press key	Step through a department group.	None	#



Table 3-4 Function Key Codes by Feature (Continued)

To program a key, press Speaker, dial 751 (for 2-digit codes) or 752 (for 3-digit codes), press the key and enter the code (e.g., 48 for Voice Over).

For this feature...	Use this key...	When you ...	Key Lamp Status	Also See Svc Code
Transfer	<b>Code:</b> 06 <b>Operation:</b> Establish call + Hold + Ext + Press key	Transfer a call.	None	-
Trunk Group Routing	<b>Code:</b> *05 <b>Operation:</b> Press key	Access a trunk using Trunk Group Routing.	On red when active	9
Trunk Groups	<b>Code:</b> *02 + TRK group (1~9 or 001~100) <b>Operation:</b> Press key	Use a trunk group key to access a Trunk Group.	On red when active	704
Trunk Queuing	<b>Code:</b> 35 <b>Operation:</b> Hear busy tone for Trk + Press key	Camp On or Queue for a trunk.	On red while camped on	-
Voice Response System (VRS) (Park and Page) (Personal Greeting)	<b>Code:</b> 17 <b>Operation:</b> Press key + device type code + requested data (depends on device selected).	Set up Call Forwarding Off-Premise, Selectable Display Messaging, VRS Park and Page or VRS Personal Greeting.	Flashes red	*4
Voice Mail	<b>Code:</b> 83 + code (0~4) <b>Operation:</b> Press key	Use Voice Mail Service.	Flashes slowly when monitoring	-
	<b>Code:</b> 77 + extension or Message Center number <b>Operation:</b> Press key	Call Voice Mail or leave a message.	Flashes green on your key for your messages or flashes red for the Message Center	*8 or 8
	<b>Code:</b> 78 + 0 <b>Operation:</b> Set up call + Press key	Use Voice Mail Record.	Slow Flash red when active	-
Voice Over	<b>Code:</b> 48 <b>Operation:</b> Hear Off-Hook Signaling tone + Press key	Initiate or respond to Voice Over.	On red when responding Hold Flash red when listening	6

Table 3-5 Function Key Codes by Number

To program a key, press Speaker, dial 751 (for 2-digit codes) or 752 (for 3-digit codes), press the key and enter the code (e.g., 48 for Voice Over).

Use this key...	For this feature...	When you ...	Key Lamp Status	Also see Svc Code
<b>Code:</b> 01 + dest. ext. or outside tel # + Hold <b>Operation:</b> Press key	Direct Station Selection, Hotline, One-Touch Calling	Call an extension or outside number using a DSS key.	Off = extension idle On = extension busy Flashing = DND	-
<b>Code:</b> 02 <b>Operation:</b> Set up call + Press key	Microphone Cutoff	Use Microphone Cutoff.	On red when activated	-
<b>Code:</b> 03 <b>Operation:</b> Press key	Do Not Disturb	Activate DND.	On red when activated	747
<b>Code:</b> 04 <b>Operation:</b> Press key	Background Music	Turn BGM on or off.	On red when activated	725
<b>Code:</b> 05 <b>Operation:</b> Press key	Headset Operation	Enable or disable Headset Operation.	On red when activated	734
<b>Code:</b> 06 <b>Operation:</b> Establish call + Hold + Ext + Press key	Transfer	Transfer a call.	None	-
<b>Code:</b> 07 <b>Operation:</b> Set up call + Press key + set up call to add + Press key twice	Conference	Set up a conference or a Meet Me Conference.	On red during setup	#1
<b>Code:</b> 08 <b>Operation:</b> Press key	Incoming Caller ID List	List incoming caller ID to extension.	Flashing when new log created On in call log	-
<b>Code:</b> 09 + mode (1~4 or 1~8) <b>Operation:</b> Press key	Night Service	Activate the Day/Night Mode.	On red when activated	718 + mode (1~4 or 1~8)
<b>Code:</b> 10 <b>Operation:</b> Press key + Dest. Ext.	Call Forwarding, Immediate	Call Forward to extension or Voice Mail.	Slowly flashes red	741
<b>Code:</b> 11 <b>Operation:</b> Press key + Dest. Ext.	Call Forwarding, Busy	Call Forward to extension or Voice Mail.	Slowly flashes red	742
<b>Code:</b> 12 <b>Operation:</b> Press key + Dest. Ext.	Call Forwarding, No Answer	Call Forward to extension or Voice Mail.	Slowly flashes red	743

Table 3-5 Function Key Codes by Number (Continued)

To program a key, press Speaker, dial 751 (for 2-digit codes) or 752 (for 3-digit codes), press the key and enter the code (e.g., 48 for Voice Over).

Use this key...	For this feature...	When you ...	Key Lamp Status	Also see Svc Code
<b>Code:</b> 13 <b>Operation:</b> Press key + Dest. Ext.	Call Forwarding, Busy/No Answer	Call Forward to extension or Voice Mail.	Slowly flashes red	744
<b>Code:</b> 14 <b>Operation:</b> Press key + Dest. Ext.	Call Forwarding, Both Ring	Call Forward to extension.	Slowly flashes red	745
<b>Code:</b> 15 <b>Operation:</b> Press key + Dest. Ext.	Call Forwarding, Follow Me	Call Forward to extension or Voice Mail.	Slowly flashes red	746
<b>Code:</b> 19 + zone (1~8) <b>Operation:</b> Press key	Paging, External	Broadcast to an External Paging Zone.	On red when activated	703 + zone
<b>Code:</b> 20 <b>Operation:</b> Press key	Paging, External	Broadcast to all External Paging Zones.	On red when activated	703 + 0
<b>Code:</b> 21 + zone (1~8, 1~9 or 01~32) <b>Operation:</b> Press Key	Paging, Internal	Broadcast to an Internal Paging Zone.	On red when activated	701 + zone
<b>Code:</b> 22 <b>Operation:</b> Press key	Paging, Internal	Broadcast to all Internal Paging Zone.	On red when activated	701 + 0 or 00
<b>Code:</b> 23 <b>Operation:</b> Press key	Meet Me Paging	Join a Meet Me Page.	None	763, 764, or 765
<b>Code:</b> 24 <b>Operation:</b> Speaker key + Press Key	Group Call Pickup	Answer a call ringing another telephone in your Pickup Group.	None	<b>*#</b>
<b>Code:</b> 25 <b>Operation:</b> Speaker key + Press key	Group Call Pickup	Answer a call ringing a telephone in another Pickup Group – if you do not know the group number.	None	769
<b>Code:</b> 26 + Pickup Group (1~8 or 1~9 or 01~64) <b>Operation:</b> Speaker key + Press key + Pickup Group	Group Call Pickup	Answer a call ringing a telephone in a specific Pickup Group.	None	768

Table 3-5 Function Key Codes by Number (Continued)

To program a key, press Speaker, dial 751 (for 2-digit codes) or 752 (for 3-digit codes), press the key and enter the code (e.g., 48 for Voice Over).

Use this key...	For this feature...	When you ...	Key Lamp Status	Also see Svc Code
<b>Code: 27</b> <b>Operation:</b> Press key + bin + Line or Speaker key	Speed Dialing	Dial a stored System Speed Dialing number.	None	#2 + bin
<b>Code: 28</b> <b>Operation:</b> Press key + bin + Line or Speaker key		Dial a stored Group Speed Dialing number.	None	#4 + bin
<b>Code: 29</b> <b>Operation:</b> Place call + Press key	Repeat Redial	Activate repeat redial while on a call.	Fast Flash while system waits to redial	-
<b>Code: 30</b> <b>Operation:</b> <u>Save:</u> Place call + Press key <u>Redial:</u> Line or Speaker key + Press key	Save Number Dialed	Save, redial or check a saved number.	None	715
<b>Code: 31</b> <b>Operation:</b> <u>Store:</u> While on call, Press key + number to store <u>Use:</u> Press key + Speaker key or line <u>Erase:</u> Speaker key + Press key	Memo Dial	Store, use or check a Memo Dial number.	None	-
<b>Code: 33</b> <b>Operation:</b> Call ext. and receive busy + Press key	Off-Hook Signaling	Signal a busy extension.	None	709
<b>Code: 34</b> <b>Operation:</b> Call ext + Press key	Barge-In	Barge-In on a co-worker's conversation.	None	710
<b>Code: 35</b> <b>Operation:</b> Call busy extension or access busy trunk + Press key	Callback / Camp-On / Trunk Queuing	Leave a Callback request at a busy extension, Camping On to a busy extension, or Queue for a busy trunk.	On red when activated	750
<b>Code: 36</b> <b>Operation:</b> Dial busy ext + Press key	Department Step Calling	Step Call through a Department Group for an idle member.	None	708

Table 3-5 Function Key Codes by Number (Continued)

To program a key, press Speaker, dial 751 (for 2-digit codes) or 752 (for 3-digit codes), press the key and enter the code (e.g., 48 for Voice Over).

Use this key...	For this feature...	When you ...	Key Lamp Status	Also see Svc Code
<b>Code:</b> 37 <b>Operation:</b> Call extension + Press key	Call Forwarding / Do Not Disturb Override	Override an extension Call Forwarding or Do Not Disturb.	On red when activated	707
<b>Code:</b> 38 <b>Operation:</b> Leave message: Call ext + Press key OR Answer message: Press key	Message Waiting	Answer/Leave a Message Waiting.	None	*0 or 0
<b>Code:</b> 39 <b>Operation:</b> Press key at destination and source + ext	Room Monitor	Activate Room Monitor.	Fast Flash red at destination, Hold Flash red at source	-
<b>Code:</b> 40 <b>Operation:</b> Press key	Handset Cutoff	Cut off the handset transmission while on a call.	On when feature active (no transmission on handset)	-
<b>Code:</b> 41 + sec. ext. <b>Operation:</b> Press key	Secretary Call	Call your secretary (using the buzzer).	On red at source Fast Flash red at destination	-
<b>Code:</b> 42 + boss ext. <b>Operation:</b> Press key		As a secretary pick up a call ringing your boss's extension.	On red when activated	-
<b>Code:</b> 43 <b>Operation:</b> TRK call + Hold + ext + Press key	Serial Call	Place a Serial Call to a co-worker.	None	-
<b>Code:</b> 44 <b>Operation:</b> Place or answer call + Press key	Hold	Put a call on System Hold (if hold key is reassigned).	None	-
<b>Code:</b> 45 <b>Operation:</b> Place or answer call + Press key		Put a call on Exclusive Hold.	None	-
<b>Code:</b> 46 <b>Operation:</b> Press key	Department Calling	Log in or log out of your Department Calling Group.	On when removed, Off when installed	650
<b>Code:</b> 47 + dest. ext. <b>Operation:</b> Press and hold key	Reverse Voice Over	Initiate Reverse Voice Over.	Full BLF red	-

Table 3-5 Function Key Codes by Number (Continued)

To program a key, press Speaker, dial 751 (for 2-digit codes) or 752 (for 3-digit codes), press the key and enter the code (e.g., 48 for Voice Over).

Use this key...	For this feature...	When you ...	Key Lamp Status	Also see Svc Code
<b>Code:</b> 48 <b>Operation:</b> Hear Off-Hook Signaling tones + Press key	Voice Over	Initiate or respond to Voice Over.	On red when responding Hold Flash red when listening	690
<b>Code:</b> 49 + ext or voice mail number <b>Operation:</b> Press key	Call Redirect	Redirect an incoming call to an extension or voice mail.	On red when activated Flashes when in DND/Call Forward	-
<b>Code:</b> 50 <b>Operation:</b> Press key	Account Codes	Enter Account Codes.	None	* or ##
<b>Code:</b> 51 + relay number <b>Operation:</b> Press key	General Purpose Relay	Activate the general purpose relay.	On when active	780
<b>Code:</b> 55 <b>Operation:</b> Do not Lift the handset + Press key + Enter extension number + Enter name + Press Hold	Name Storing	Change the name displayed on your display telephone.	None	700
<b>Code:</b> 83 + 0~4 <b>Operation:</b> Press key	Voice Mail	Use Voice Mail Service.	Flashes slowly when monitoring	-
<b>Code:</b> 77 + extension or Message Center number <b>Operation:</b> Press key		Call Voice Mail or leave a message.	Flashes green on your key for your messages or flashes red for the Message Center	*8 or 8
<b>Code:</b> 78 + Conversation Record <b>Operation:</b> Press key		Use Conversation Record.	Flashes red when recording	-
<b>Code:</b> *01 + Trunk number (001~400) <b>Operation:</b> Press key	Central Office Calls	Press a line key to place or answer a trunk call (where trunks are 001~400).	On green when seized, on red when in use (by other party), Slow Flash green when ringing, Hold flash when on Hold	#9
<b>Code:</b> *02 + TRK group (1~9 or 001~100) <b>Operation:</b> Press key	Trunk Groups	Use a trunk group key to access a Trunk Group.	On red when active	704

Table 3-5 Function Key Codes by Number (Continued)

To program a key, press Speaker, dial 751 (for 2-digit codes) or 752 (for 3-digit codes), press the key and enter the code (e.g., 48 for Voice Over).

Use this key...	For this feature...	When you ...	Key Lamp Status	Also see Svc Code
<b>Code:</b> *03 + ext. or department group <b>Operation:</b> Press key	Call Arrival (CAR) Keys	Call Arrival (CAR) Key: Place or answer a call from your virtual (phantom) extension or Call Arrival (CAR) Key: Place or answer a call to your co-worker's extension.	Slow Flash red when ringing, On red when busy	-
<b>Code:</b> *04 + orbit (01~64) <b>Operation:</b> Place or answer call + Press key	Park	Place a call into or retrieve a call from a Park Orbit.	Fast Flash when orbit is busy (green at originator, red at others)	#6 (Park) *6 (pickup)
<b>Code:</b> *06 + Network number (1~50) <b>Operation:</b> Press key	Networking	Access a networked trunk.	None	-

Table 3-5 Function Key Codes by Number (Continued)

To program a key, press Speaker, dial 751 (for 2-digit codes) or 752 (for 3-digit codes), press the key and enter the code (e.g., 48 for Voice Over).

Use this key...	For this feature...	When you ...	Key Lamp Status	Also see Svc Code
<p><b>Code: *10</b>  <b>Operation:</b> Press key to log in                      Press key + 1 to log out or 0 to cancel</p>	Automatic Call Distribution ()	<p><b>Basic Operation</b>                      Log in or out of a Group.</p>	<p>On red when logged in                      Off when logged out</p>	*5
<p><b>Code: *12</b>  <b>Operation:</b> Press key</p>		<p><b>Emergency Call</b>                      Place or receive an Emergency Call.</p>	<p>On while calling your supervisor or after being answered by your supervisor                      Flashing fast at the supervisor while ringing</p>	-
<p><b>Code: *13</b>  <b>Operation:</b> Press key</p>		<p><b>Rest Mode</b>                      Enable/disable Rest Mode.</p>	<p>On red when Rest Mode enabled                      Off when Rest Mode disabled</p>	-
<p><b>Code: *14</b>  <b>Operation:</b> Press key + Press 1 (Yes) or 2 (No)</p>		<p><b>Out of Service</b>                      Take a Group out of service (for Group Supervisors only), or Take all Groups out of service (for System Supervisors only).</p>	<p>On red when a group is out of service</p>	-
<p><b>Code: *15</b>  <b>Operation:</b> Call busy agent + Press key</p>		<p><b>Terminal Monitor</b>                      Monitor a Agent's conversation.</p>	<p>On red while monitoring,                      Off when not monitoring</p>	-
<p><b>Code: *16</b>  <b>Operation:</b> Press key to put agent on hold.                      Press key again + 1 to hang up agent or 0 to bring agent back into call.</p>		<p><b>Supervisor Split</b>                      Switch (split) between a Agent and their outside caller after answering an emergency call.</p>	<p>On while agent is on hold</p>	-



Table 3-5 Function Key Codes by Number (Continued)

To program a key, press Speaker, dial 751 (for 2-digit codes) or 752 (for 3-digit codes), press the key and enter the code (e.g., 48 for Voice Over).

Use this key...	For this feature...	When you ...	Key Lamp Status	Also see Svc Code
<b>Code: *17</b> <b>Operation:</b> Press Key	Automatic Call Distribution () <i>(continued)</i>	<b>Work Time</b> Enable/disable Work Time.	On when Work Time enabled, Flashing (while on a call) if Auto Work time enabled Off when Work Time disabled	-
<b>Code: *18 + Group Number</b> <b>Operation:</b> Press key		Enable overflow.	On red when activated Slowly flashes red when disabled	-
<b>Code: *19</b> <b>Operation:</b> Press key while on-hook + Vol Up or Vol Down to scroll		Queue Status Check View the Queue Status of each group.	None	-



## Feature Availability by Software Revision

## Chapter 4

### SECTION 1 FEATURE AVAILABILITY CHART

This chapter provides an alphabetical listing of the features that are available with each software revision.

Note: the following table provides a breakout of the availability of each feature by revision, see [Table 4-1 Feature Availability by Software Revision](#).

**S = Supported Feature**

**N/A = Feature not supported for this software release**

**E = Supported and Enhanced**

Table 4-1 Feature Availability by Software Revision

UNIVERGE SV9100 Feature Name	Ver. 1000	Ver. 3000	Ver. 4000	Ver. 5000	Ver. 6000
Account Code Entry	S	S	S	S	S
Account Code – Forced/Verified/Unverified	S	S	S	S	S
Alarm	S	S	S	S	S
Alarm Reports	S	E	S	S	S
Alphanumeric Display	S	S	S	S	S
Analog Communications Interface (ACI)	S	S	S	S	S
Ancillary Device Connection	S	S	S	S	S
Answer Hold	S	S	S	S	S
Answer Key	S	S	S	S	S
Attendant Call Queuing	S	S	S	S	S
Automatic Release	S	S	S	S	S
Automatic Route Selection (ARS)	S	S	S	S	S
Background Music	S	S	S	S	S
Barge-In	S	S	S	S	S
Battery Backup – System Memory	S	S	S	S	S

Table 4-1 Feature Availability by Software Revision (Continued)

UNIVERGE SV9100 Feature Name	Ver. 1000	Ver. 3000	Ver. 4000	Ver. 5000	Ver. 6000
Battery Backup – System Power	S	S	S	S	S
Callback	S	S	S	S	S
Caller ID Call Return	S	S	S	S	S
Caller ID	S	S	S	S	S
Caller ID – Flexible Calling Party Number	N/A	N/A	S	S	S
Caller ID – Flexible Ringing	S	S	S	S	S
Caller ID – Memo Display Function	S	S	S	S	S
Call Appearance (CAP) Keys	S	S	S	S	S
Call Arrival (CAR) Keys	S	S	S	S	S
Call Duration Timer	S	S	S	S	S
Call Forwarding	S	S	S	S	S
Call Forwarding with Follow Me	S	S	S	S	S
Call Forwarding – Centrex	S	S	S	S	S
Call Forwarding, Off-Premise	S	S	S	S	S
Call Forwarding/Do Not Disturb Override	S	S	S	S	S
Call Monitoring	S	S	S	S	S
Call Redirect	S	S	S	S	S
Call Waiting/Camp-On	S	S	S	S	S
Central Office Calls, Answering	S	S	S	S	S
Central Office Calls, Answering – Auto Attendant Enhancement	N/A	N/A	N/A	S	S
Central Office Calls, Answering – Playing MOH During VRS/DISA Transfer	N/A	N/A	N/A	S	S
Central Office Calls, Placing	S	S	S	S	S
Class of Service	S	S	S	S	S
Clock/Calendar Display	S	S	S	S	S
Code Restriction	S	S	S	S	S
Code Restriction Override	S	S	S	S	S
Code Restriction, Dial Block	S	S	S	S	S
Conference	S	S	S	S	S
Conference – Remote	S	S	S	S	S
Conference – Remote Conference Recording	N/A	S	S	S	S

Table 4-1 Feature Availability by Software Revision (Continued)

UNIVERGE SV9100 Feature Name	Ver. 1000	Ver. 3000	Ver. 4000	Ver. 5000	Ver. 6000
Conference, Voice Call/Privacy Release	S	S	S	S	S
Contact Center	S	E	E	S	S
Continued Dialing	S	S	S	S	S
Cordless DECT Terminals	S	S	S	S	S
Cordless Telephone Connection	S	S	S	S	S
CO Message Waiting Indication	S	S	S	S	S
Data Line Security	S	S	S	S	S
Delayed Ringing	S	S	S	S	S
Department Calling	S	S	S	S	S
Department Step Calling	S	S	S	S	S
Dialing Number Preview	S	S	S	S	S
Dial Pad Confirmation Tone	S	S	S	S	S
Dial Tone Detection	S	S	S	S	S
Digital Trunk Clocking	S	S	S	S	S
Directed Call Pickup	S	S	S	S	S
Directory Dialing	S	S	S	S	S
Direct Inward Dialing (DID)	S	S	S	S	S
Direct Inward Line (DIL)	S	S	S	S	S
Direct Inward System Access (DISA)	S	S	S	S	S
Direct Station Selection (DSS) Console	S	S	S	S	S
Distinctive Ringing, Tones and Flash Patterns	S	S	S	S	S
Door Box	S	S	S	S	S
Do Not Disturb	S	S	S	S	S
Drop Key	S	S	S	S	S
Ecology	S	S	S	S	S
E911 Compatibility	S	S	S	S	S
Facsimile CO Branch Connection	S	S	S	S	S
Flash	S	S	S	S	S
Flexible System Numbering	S	S	S	S	S
Flexible Timeouts	S	S	S	S	S
Forced Trunk Disconnect	S	S	S	S	S

Table 4-1 Feature Availability by Software Revision (Continued)

UNIVERGE SV9100 Feature Name	Ver. 1000	Ver. 3000	Ver. 4000	Ver. 5000	Ver. 6000
General Purpose Relay	S	S	S	S	S
Group Call Pickup	S	S	S	S	S
Group Listen	S	S	S	S	S
Handset Mute	S	S	S	S	S
Handsfree and Monitor	S	S	S	S	S
Handsfree Answerback/Forced Intercom Ringing	S	S	S	S	S
Headset Operation	S	S	S	S	S
Hold	S	S	S	S	S
Hotel/Motel	S	E	E	S	S
Hotline	S	S	S	S	S
Hot Key-Pad	S	S	S	S	S
Howler Tone Service	S	S	S	S	S
InControl Call Reporting	N/A	N/A	N/A	S	S
InMail	S	S	S	S	S
InMail – Automatic Access to VM by Caller ID	S	S	S	S	S
InMail – Cascade Message Notification	S	S	S	S	S
InMail – Email Notification	S	S	S	S	S
InMail – Find-Me Follow-Me	S	S	S	S	S
InMail – Language Setting	S	S	S	S	S
InMail – Park and Page	S	S	S	S	S
InMail – Upload Download Audio	S	S	S	S	S
Instant Access Application (IAA)	S	S	S	S	S
Intercom	S	S	S	S	S
InVPN Server	N/A	N/A	N/A	S	S
IP Multiline Station (SIP)	S	S	S	S	S
IP Multiline Station (SIP) – MLC Mobile	N/A	N/A	N/A	S	S
IP Multiline Station (SIP) – ML440 Cordless	S	S	S	S	S
IP Multiline Station (SIP) – ML440/G566/G266 with AP400/AP300	S	S	S	S	S
IP Multiline Telephone (UT880)	S	S	S	S	S
IP Single Line Telephone (SIP)	S	E	E	S	S
IP Single Line Telephone (SIP) – NAT Mode	S	S	S	S	S

Table 4-1 Feature Availability by Software Revision (Continued)

UNIVERGE SV9100 Feature Name	Ver. 1000	Ver. 3000	Ver. 4000	Ver. 5000	Ver. 6000
IP Trunk – H3.23	S	S	S	S	S
IP Trunk – Multi Gateway Address Support	N/A	N/A	N/A	S	S
IP Trunk – TLS Support on SIP Trunk	N/A	N/A	N/A	S	S
IP Trunk – (SIP) Session Initiation Protocol	S	E	E	S	S
IP Video Doorphone	S	S	S	S	S
IP/Digital Call Logging	S	S	S	S	S
ISDN Compatibility	S	S	S	S	S
IVR – Appointment Reminder Server	S	S	S	S	S
IVR – Broadcast Server	S	S	S	S	S
K-CCIS – Call Rerouting	S	S	S	S	S
K-CCIS – IP	S	S	S	S	S
K-CCIS – IP with PVA	S	S	S	S	S
K-CCIS – T1	S	S	S	S	S
Last Number Redial	S	S	S	S	S
Licensing	S	S	S	S	S
Line Load Control	S	S	S	S	S
Line Preference	S	S	S	S	S
Long Conversation Cutoff	S	S	S	S	S
Loop Keys	S	S	S	S	S
Maintenance	S	S	S	S	S
Meet Me Conference	S	S	S	S	S
Meet Me Paging	S	S	S	S	S
Meet Me Paging Transfer	S	S	S	S	S
Memo Dial	S	S	S	S	S
Message Waiting	S	S	S	S	S
Microphone Cutoff	S	S	S	S	S
Migration – SV8100/SV8300	S	S	S	S	S
Migration – SV9100-S to SV9100-E System	S	S	S	S	S
Mobile Extension	S	S	S	S	S
Mobile Extension – Answer Park Hold	N/A	N/A	S	S	S
Multiple Trunk Types	S	S	S	S	S

Table 4-1 Feature Availability by Software Revision (Continued)

UNIVERGE SV9100 Feature Name	Ver. 1000	Ver. 3000	Ver. 4000	Ver. 5000	Ver. 6000
Multi-Device Support	N/A	N/A	S	S	S
Music on Hold	S	S	S	S	S
Name Storing	S	S	S	S	S
NEC Communications Analyst	S	S	S	S	S
NEC Meeting Center (NMC)	N/A	N/A	N/A	N/A	N/A
Night Service	S	S	S	S	S
Off-Hook Signaling	S	S	S	S	S
One-Touch Calling	S	S	S	S	S
Operator	S	S	S	S	S
(OPX) Off-Premise Extension	S	S	S	S	S
Paging, External	S	S	S	S	S
Paging, External (VRS)	S	S	S	S	S
Paging, Internal	S	S	S	S	S
Park	S	S	S	S	S
PBX Compatibility	S	S	S	S	S
PC Programming	S	S	S	S	S
PC Programming – Security	N/A	N/A	N/A	N/A	S
PC Programming – WebPro HTTPS Support	N/A	N/A	S	S	S
PhonePro	N/A	N/A	S	S	S
Power Failure Transfer	S	S	S	S	S
Prime Line Selection	S	S	S	S	S
Private Line	S	S	S	S	S
Programmable Function Keys	S	S	S	S	S
Programming from a Multiline Terminal	S	S	S	S	S
Pulse to Tone Conversion	S	S	S	S	S
Redial Function	S	S	S	S	S
Remote (System) Upgrade	S	S	S	S	S
Repeat Redial	S	S	S	S	S
Resident System Program	S	S	S	S	S
Reverse Voice Over	S	S	S	S	S
RGA Conference	S	S	S	S	S



Table 4-1 Feature Availability by Software Revision (Continued)

UNIVERGE SV9100 Feature Name	Ver. 1000	Ver. 3000	Ver. 4000	Ver. 5000	Ver. 6000
RGA Router	S	S	S	S	S
Ringdown Extension, Internal/External	S	S	S	S	S
Ring Groups	S	S	S	S	S
Room Monitor	S	S	S	S	S
Save Number Dialed	S	S	S	S	S
Secondary Incoming Extension	S	S	S	S	S
Secretary Call (Buzzer)	S	S	S	S	S
Secretary Call Pickup	S	S	S	S	S
Security	S	S	S	S	S
Selectable Display Messaging	S	S	S	S	S
Selectable Ring Tones	S	S	S	S	S
Serial Call	S	S	S	S	S
Simple MCU Video	S	S	S	S	S
Simple Network Management Protocol (SNMP)	S	S	S	S	S
Single Line Telephones, Analog 500/2500 Sets	S	S	S	S	S
Softkeys	S	S	S	S	S
Speed Dial – System/Group/Station	S	E	S	S	S
Speed Dial – Telephone Book	S	S	S	S	S
Station Hunt	S	S	S	S	S
Station Message Detail Recording	S	S	S	S	S
Station Name Assignment – User Programmable	S	S	S	S	S
Station Relocation	S	S	S	S	S
SV9100 InGuard	N/A	N/A	N/A	N/A	S
SV9100 NetLink	S	S	S	S	S
SV9100 PoE Gigabit Switch	S	S	S	S	S
SV9100 Terminals	S	S	S	S	S
SV9100 UC Suite	S	S	S	S	S
Synchronous Ringing	S	S	S	S	S
System Caller Log	S	S	S	S	S
T1 Trunking (with ANI/DNIS Compatibility)	S	S	S	S	S
Tandem Ringing	S	S	S	S	S

Table 4-1 Feature Availability by Software Revision (Continued)

UNIVERGE SV9100 Feature Name	Ver. 1000	Ver. 3000	Ver. 4000	Ver. 5000	Ver. 6000
Tandem Trunking (Unsupervised Conference)	S	S	S	S	S
TAPI Compatibility	S	S	S	S	S
Tone Override	S	S	S	S	S
Traffic Reports	S	S	S	S	S
Transfer	S	S	S	S	S
Trunk Groups	S	S	S	S	S
Trunk Group Routing	S	S	S	S	S
Trunk Queuing/Camp-On	S	S	S	S	S
UM8000 Mail	S	S	S	S	S
uMobility – Wi-Fi Client	S	S	S	S	S
Unicast/Multicast Paging Mode	S	S	S	S	S
Uniform Call Distribution (UCD)	S	S	S	S	S
Uniform Numbering Network	S	S	S	S	S
Universal Slots	S	S	S	S	S
User Programming Ability	S	S	S	S	S
Video Conference with Web RTC	N/A	N/A	S	E	S
Virtual Extensions	S	S	S	S	S
Virtual Extensions – Incoming Call History	N/A	N/A	N/A	S	S
Voice Call Recording	S	S	S	S	S
Voice Mail Integration (Analog)	S	S	S	S	S
Voice Mail Message Indication on Line Keys	S	S	S	S	S
Voice Over	S	S	S	S	S
Voice Response System (VRS)	S	S	S	S	S
Voice Response System (VRS) Upload Download Audio	S	S	S	S	S
Voice Response System (VRS) – Call Forwarding – Park and Page	S	S	S	S	S
Volume Controls	S	S	S	S	S
Warning Tone for Long Conversation	S	S	S	S	S
Wireless DECT (SIP)	S	S	S	S	S



# ***UNIVERGE*<sup>®</sup> SV9100**

## **Features and Specifications Manual**